

2019
GENERAL BOOK

2019

GENERAL BOOK



ARIOSTEA[®]
HIGHTECH•MARBLE•STONE & WOOD

ULTRA[®]
GREAT SURFACES

INDEX

ARIOSTEA	4
ULTRA	18
APPLICATION DESIGN	26
ULTRA MARMI	56
ULTRA ONICI	112
ULTRA METAL	130
ULTRA CON.CREA.	134
ULTRA TEKNOSTONE	138
ULTRA PIETRE	142
ULTRA RESINE	148
ULTRA ICEMENTI	152
ULTRA BLEND.HT	156
ULTRA IRIDIUM	160
MARMI cento2cento	164
MARMI CLASSICI	182
PIETRE cento2cento	214
CON.CREA.	224
TEKNOSTONE	236
NORTHSTONE	250
MATERIE HIGH-TECH	262
PIETRE NATURALI HIGH-TECH	282
CM2	316
LEGNI HIGH-TECH	336
WOODRAW	384
IRIDIUM	394
INSTALLATION	398
INFORMATION AND CODES	405
TECHNICAL FEATURES	406
CERTIFICATIONS	408
SAFE SYSTEM	412
CODES AND SIZES	414
PACKING AND WEIGHTS	425

Qualità assoluta, tecnologia brevettata e rispetto per l'ambiente confermano la leadership di Ariosteal nella produzione di lastre compatte in gres fine porcellanato a tutto spessore.

L'unione di alta qualità ed ineguagliabile tecnologia ha portato alla reinterpretazione dei più rari, raffinati e costosi prodotti della natura, migliorandone anche le caratteristiche tecnico-qualitative e diventando in molti casi memoria storica di materiali ormai scomparsi. In questo modo Ariosteal permette a chiunque di apprezzare e fruire di tutti i vantaggi dei materiali più pregiati, con l'aggiunta di straordinaria funzionalità, igiene, sicurezza e durevolezza al tempo stesso: il tutto in modo assolutamente alternativo anche dal punto di vista bio-ecologico. Una concezione nuova ed in costante rinnovamento alla ricerca di una qualità superiore della materia.

TECNOLOGIA

Le tecnologie di Ariosteal sono uniche: ideate, progettate e costruite direttamente dall'azienda stessa nei propri stabilimenti, esse sono interamente (know-how, meccanica e software) tutelate con brevetti a livello internazionale. Anche le lastre in porcellanato high-tech Ariosteal sono create esclusivamente con selezionatissime materie prime naturali e minerali che vengono trasformate da un processo analogo a quello della trasformazione delle rocce sulla terra nel corso dei millenni. Sottoposte a pressioni e temperature elevatissime (1300°), queste materie prime scrupolosamente ricercate in tutto il mondo danno vita ad un materiale estremamente compatto, omogeneo nell'intera massa ed inassorbente.

RESISTENZA E VERSATILITÀ

La compattezza e l'uniformità strutturale assicurano un'eccezionale resistenza all'abrasione, alla flessione, al gelo ed agli agenti chimici, consentendo l'utilizzo dei prodotti Ariosteal per ogni tipo di destinazione d'uso, sia per pavimentare che per rivestire.

Dagli ambienti ad elevato calpestio alle innumerevoli applicazioni esterne (Pietre e Legni High-Tech sono le più ricercate) sino ad arrivare a contesti architettonici di altissimo pregio dove il pavimento si debba armonicamente inserire in contesti arredativi di classe assoluta.

DURABILITÀ

Le lastre Ariosteal sono realizzate in massa unica, ingeliva e resistente agli attacchi chimici ed atmosferici. Esse sono pertanto garanzia di stabilità e durevolezza nel tempo, idonee a qualunque impiego e ad ogni ambiente sia interno che esterno, poiché mantengono inalterate le proprie caratteristiche tecniche ed estetiche e non necessitano di manutenzione, garantendo considerevoli risparmi di tempo ed energie.

INASSORBENZA E PULIZIA

Il coefficiente di assorbimento praticamente nullo rende i materiali high-tech Ariosteal pressoché inattaccabili alle macchie e alla sporcizia, preservandone la bellezza a lungo nel

tempo. Ciò rende molto più agevole, economica ed ecologica anche la cura quotidiana di un pavimento o di un rivestimento Ariosteal con un evidente risparmio di tempo, di energie e di costi.

NATURA HIGH-TECH

La tecnologia Ariosteal è quindi in grado di ricreare la continuità dei materiali con la storia, la cultura ed il gusto formatosi nei secoli ma ne sviluppa anche le performance (grazie alla continua innovazione), ampliandone pertanto le potenzialità applicative e le interpretazioni estetiche e tecniche in modo esponenziale.

Le caratteristiche tecniche ed estetiche delle lastre high-tech Ariosteal sono uniformi in tutto lo spessore e consentono le stesse lavorazioni dei marmi, dei legni e delle pietre ornamentali valorizzando ricchezza cromatica e venature che sono uniche del nostro materiale.

COSTANZA QUALITATIVA

La gestione elettronica computerizzata del processo produttivo garantisce qualità strutturali costanti nel tempo e risultati estetici variabili in modo naturale ma controllato.

Soluzioni tecniche innovative consentono infatti di ottenere variazioni casuali delle venature e della tessitura cromatica, evitando ogni tipo di ripetitività: ciascuna lastra è diversa dalle altre, un pezzo unico, con venature uniche e che attraversano la lastra in tutto il suo spessore, esattamente come creato dalla natura.

MONOCALIBRO

Le operazioni di squadratura e di rettifica in un'unica dimensione di fabbricazione (monocalibro) a cui vengono sottoposti tutti i prodotti high-tech Ariosteal, in tutte le finiture, garantiscono non solo costanza qualitativa nelle dimensioni dei prodotti forniti (facilitando notevolmente la progettazione ed il lavoro di tutti gli interessati) ma consentono anche l'abbinamento di superfici e materiali diversi.

Questa caratteristica qualitativa permette inoltre la modularità nella posa tra i numerosi formati, favorita anche dallo spessore uniforme tra i vari materiali (monospessore).

È possibile inoltre effettuare la posa con giunti molto ridotti, ottenendo risultati esteticamente sempre più gradevoli.

PERSONALIZZAZIONE

Le infinite geometrie compositive, la possibilità di creare elementi grafici con la tecnologia dell'idrogetto e dell'incisione cromatica al laser, la ricchezza di elementi ornamentali e degli infiniti pezzi speciali proposti, rendono praticamente illimitate le possibilità di personalizzazione di ogni spazio commerciale, dai più ampi e frequentati ai più raffinati ed esclusivi.



ARIOSTEA®

MISSION & GREEN FACTORY

ARIOSTEA, DAL 1961

IL CUORE PULSANTE DELL'HIGH-TECH



ARIOSTEA

THE BEATING HEART
OF CUTTING-EDGE
TECHNOLOGY
SINCE 1961

ARIOSTEA®





Total quality, patented technology and environmental protection have assured Ariostea's leadership in the production of compact porcelain tiles in all sizes.

High quality combined with unrivalled technology has enabled us to re-interpret some of the rarest, most refined and valuable products of nature, while also enhancing their technical and qualitative properties, saving many of these materials from oblivion.

In this way, Ariostea allows you to appreciate and take full advantage of some of the most prized materials available. Other hallmarks include exceptional functionality, hygiene, safety and long-lasting durability: for what can also be seen as the perfect green, ecological alternative. The concept of the material is new and constantly being developed upon in the search for ultimate quality.

TECHNOLOGY

Ariostea's technologies are unique: they are devised, designed and implemented directly in-house at the company's own sites, and are all protected by international patents (which cover the know-how, mechanics and software).

Ariostea's high-tech porcelain tiles are made using only the choicest of natural and mineral raw materials which are subjected to a process similar to that undergone by rocks on our planet over millennia. Put to high pressure and intense heat (1300°) these raw materials, carefully researched worldwide, form a material of extreme compactness, homogeneousness and non-absorbency.

RESISTANCE AND VERSATILITY

The compactness and structural uniformity of Ariostea's products ensure their exceptional resistance to abrasion, flexure, frost and chemical agents, and therefore make them ideal for any application, whether for floors or for walls.

The tiles can be laid in areas subject to intensive use, put to a whole range of external applications (High-Tech Stone and Wood are among the most sought after) and used in architecturally impressive buildings where tiled floors have to blend gracefully in with stylish surroundings.

DURABILITY

Ariostea's tiles are solid, frost-proof and resistant to chemical and atmospheric agents. They are therefore a guarantee of stability and long-lasting durability. They are suited to any environment inside or outside as they maintain their same technical and aesthetic properties over time and do not require maintenance, saving you considerable time and energy.

NON-ABSORBENCY AND CLEANING

A virtually insignificant degree of absorbency means Ariostea's high-tech materials are practically impregnable to stains and dirt, able therefore to preserve their beauty over time.

This makes it much easier, more economical and ecological to look after an Ariostea floor or wall, saving you time, energy and expense.

HIGH-TECH NATURE

Ariostea's technology therefore recreates materials in keeping with age-old history, culture and taste, while also enhancing their performance (due to constant innovation), broadening their applicative potential and aesthetic and technical qualities on an exponential level. The technical and aesthetic properties of Ariostea's high-tech tiles are uniform throughout, ensuring consistent processing of all the marble, wood and ornamental stone. In this way we can preserve all the rich colours and veining unique to our materials.

CONSTANT QUALITY

Computerized electronic management of the production process guarantees long-lasting structural quality and control over naturally variable aesthetics.

Innovative technical solutions enable random variation in the veining and blends of colours, avoiding all repetition: each tile is unique, different from all the others, with its very own veining that courses all the way through exactly as intended by nature.

SINGLE CALIBRE

The squaring and grinding in a single manufacturing process (single calibre) to which are put all of Ariostea's high-tech products, regardless of finish, guarantee not only constant quality in terms of the finished products' dimensions (vastly simplifying the design and processing of all the tiles) but also enable the combination of different surfaces and materials.

This standard of quality also permits modular installation in the many sizes, aided moreover by the uniform thickness of the various materials (single thickness).

It is also possible to lay the tiles with the thinnest of joins for a more aesthetically pleasing result.

CUSTOMIZATION

The infinite forms and shapes, the option of creating graphical elements with hydrojet and chromatic laser-cutting technology, the sheer variety of ornamental features and an endless range of special parts offer almost unlimited possibilities for customizing all commercial premises, no matter how large, busy, refined or exclusive.

Beste Qualität, eine patentierte Technologie und Umweltschutz sichern Ariostea die Führung in der Herstellung kompakter und durchgehend gesinterter Feinsteinzeugfliesen.

Die hohe Qualität, vereint mit bester Technologie hat zu einer Neuinterpretierung der seltensten, edelsten und kostbarsten Erzeugnisse der Natur geführt und deren technische und qualitative Eigenschaften verbessert. In vielen Fällen erinnern die Produkte von Ariostea an längst verschwundene Materialien.

Auf diese Weise macht Ariostea dem Verbraucher sämtliche Vorteile der wertvollsten Materialien zugänglich, während gleichzeitig ein besonderes Augenmerk auf Funktionalität, Hygiene, Sicherheit und Haltbarkeit gelegt werden. Auch der bio-ökologische Standpunkt wird auf eine absolut alternative Weise respektiert.

Ein neues und in ständiger Erneuerung begriffenes Konzept auf der ständigen Suche nach besserer Materialqualität.

TECHNOLOGIE

Das Unternehmen Ariostea bedient sich einzigartiger Technologien: diese werden direkt in den Werken entworfen, geplant und hergestellt und sind alle (Know-how, Mechanik und Software) durch internationale Patente geschützt.

Auch die Platten aus Hightech-Steinzeug von Ariostea werden ausschließlich aus besten natürlichen Rohmaterialien und Mineralen hergestellt, die durch ein Verfahren verarbeitet werden, das analog zu dem ist, wie es die Natur im Lauf der Jahrtausende auf die Felsen ausübt. Die kostbaren, aus den verschiedensten Ländern der Erde stammenden Rohmaterialien werden sehr hohem Druck und extrem hohen Temperaturen (1300°) ausgesetzt, wodurch ein äußerst kompaktes, durchgehend gesintertes und wasserabweisendes Material entsteht.

WIDERSTANDSFÄHIGKEIT UND VIELSEITIGKEIT

Die Kompaktheit und die strukturelle Gleichförmigkeit gewährleisten ein abriebfestes, flexibles und gegen Frost und chemische Wirkstoffe beständiges Material und ermöglichen die Anwendung der Produkte von Ariostea sowohl als Bodenbelag als auch als Wandverkleidung. Diese reicht von stark begangenen Flächen und zahllosen Außenanwendungen (High tech-Platten in Stein- und Holzoptik sind besonders begehrt) bis hin zum Einsatz in architektonischen Baukontexten von höchstem Niveau, in welche sich der Boden harmonisch in die erstklassigen Inneneinrichtungen einfügen muss.

HALTBARKEIT

Die Fliesen von Ariostea bestehen aus durchgehend gesinterter, frost- und witterungsbeständiger und gegen chemische Einflüsse beständiger Tonmasse. Sie sind zeitlos stabil und haltbar, eignen sich für vielfältige Anwendungen im Innen- wie im Außenbereich und bewahren unverändert ihre technischen und ästhetischen Eigenschaften. Sie bedürfen keiner Instandhaltung, wodurch Zeit und Energie gespart werden.

WASSERABWEISUNG UND REINIGUNG

Der Absorptionskoeffizient ist praktisch null und macht die Hightech-Materialien von Ariostea extrem beständig gegen

Flecken und Schmutz, so dass sie ihre Schönheit fast zeitlos bewahren. Damit wird auch die tägliche Pflege der Böden oder der Wandverfliesungen einfacher, billiger und umweltfreundlicher und gleichzeitig werden Zeit, Energie und Kosten gespart.

HIGH TECH-NATUR

Die Technologie von Ariostea ist in der Lage, die Kontinuität der Materialien mit der Geschichte, der Kultur und dem Geschmack so wiederherzustellen, wie sie sich über die Jahrhunderte hinaus entwickelt haben, während gleichzeitig die Leistungen (dank der ständigen Innovation) und die Anwendungsmöglichkeiten sowie die ästhetischen Interpretationen exponentiell erweitert werden. Die technischen und ästhetischen Eigenschaften der High tech-Fliesen von Ariostea sind einheitlich und durchgehend in der gesamten Fliesenmasse verteilt und ermöglichen dadurch die gleiche Verarbeitung wie bei Marmor, Holz und Zierstein. Auf diese Weise können die Farbvielfalt und die einzigartige Maserung unserer Materialien zur vollen Geltung gebracht werden.

GLEICH BLEIBENDE QUALITÄT

Die computergestützte elektronische Steuerung des Herstellungsverfahrens gewährleistet eine langfristig gleich bleibende strukturelle Qualität und ein ästhetisches, auf natürliche und kontrollierte Weise variables Ergebnis.

Die innovativen technischen Systeme machen es möglich, zufällige Variationen der Maserungen und der Farbgebung wie in der Natur zu imitieren und somit jede Art von Eintönigkeit zu vermeiden: Jede Fliese unterscheidet sich von den anderen und ist ein Einzelstück mit besonderen Maserungen, die die Fliese in ihrer ganzen Stärke durchziehen, so als hätte sie die Natur geschaffen.

EINKALIBER

Die Abvierungs- und Rektifizierungsvorgänge in einer einzigen Herstellungsgröße (Einkaliber), denen alle High tech-Produkte von Ariostea in all ihren Ausführungen unterzogen werden, gewährleisten nicht nur eine qualitative Beständigkeit bei den Abmessungen der gelieferten Produkte (wodurch die Planung und die Arbeit alle betreffenden Handwerker beträchtlich erleichtert wird), sondern gestatten auch die Kombination verschiedener Oberflächen und Materialien.

Diese Qualitätseigenschaft ermöglicht außerdem die Modularität beim Verlegen der jeweiligen zahlreichen Formate. Dies wird auch durch die einheitliche Stärke der verschiedenen Materialien begünstigt (nur eine Stärke).

Dadurch kann das Verlegen mit sehr kleinen Fugen ausgeführt werden, wodurch sehr ästhetische Resultate erzielt werden.

INDIVIDUELLE GESTALTUNG

Die unendlichen kompositorischen Geometrien, die Möglichkeit, mittels der Wasserstrahltechnik und dem chromatischen Laserschnitt graphische Elemente zu schaffen, der Reichtum an ornamentalen Elementen und das unendliche Angebot von Sonderstücken, machen die Möglichkeiten für die individuelle Gestaltung jedes kommerziellen Bereichs praktisch unbegrenzt. Sie eignen sich daher gleichermaßen für große und häufig begangene wie für vornehme und exklusive Räumlichkeiten.



ARIOSTEA SEIT 1961
DAS PULSIERENDE
HERZ DER
HOCHTECHNOLOGIE

A photograph of a modern architectural courtyard. In the center, a large, young tree with green leaves stands in a bed of dark mulch. To the left, a row of tall, dark, rectangular columns supports a white, arched structure. To the right, a modern building with large windows is visible. The ground is paved with light-colored concrete slabs. The sky is overcast with grey clouds.

ARIOSTEA
LE COEUR DE LA
HAUTE-TECHNOLOGIE
DEPUIS 1961



Qualité absolue, technologie brevetée et respect de l'environnement, confèrent à Ariostea une place de leader dans la production de dalles compactes en grès fin porcelainé, toutes épaisseurs. L'association d'une très grande qualité et d'une technologie unique ont permis de réinterpréter les produits de la nature les plus rares, les plus raffinés et les plus coûteux, en améliorant également leurs caractéristiques techniques et leur qualité et en devenant dans de nombreux cas la mémoire historique de matériaux désormais disparus.

De cette façon, Ariostea permet à chacun d'apprécier et d'exploiter tous les avantages des matériaux les plus appréciés en leur apportant des fonctionnalités extraordinaires en matière d'hygiène, de sécurité et de durabilité réunies en un seul matériau : le tout de façon totalement alternative, y compris du point de vue bioécologique.

Une conception nouvelle qui se renouvelle constamment en quête d'une qualité supérieure de la matière.

TECHNOLOGIE

Les technologies d'Ariostea sont uniques : conçues, développées et mises au point par l'entreprise, dans ses propres locaux, et intégralement protégées (savoir-faire, mécanique et logiciel) par des brevets reconnus au niveau international.

Même les dalles porcelainées de haute-technologie d'Ariostea sont créées exclusivement avec des matières premières naturelles et minérales faisant l'objet d'une sélection rigoureuse qui sont transformées au terme d'un processus analogue à celui de la transformation des roches sur la terre au fil des millénaires.

Soumises à des pressions et à des températures très élevées (1300°C), ces matières premières scrupuleusement recherchées dans le monde entier donnent vie à un matériau extrêmement compact, homogène dans la masse et imperméable.

RÉSISTANCE ET POLYVALENCE

La nature compacte et l'uniformité structurelle assurent une résistance exceptionnelle à l'abrasion, à la flexion, au gel et aux agents chimiques. Ils permettent l'utilisation des produits Ariostea dans des contextes variés, qu'il s'agisse de paver ou de revêtir.

Ces dalles sont adaptées à une gamme étendue d'utilisations allant des environnements soumis à un piétinement important, aux infinies applications en extérieur (les pierres et le bois high-tech sont les plus recherchés), en passant par des contextes architectoniques de très grande valeur où le revêtement de sol doit être en parfaite harmonie avec un mobilier luxueux.

DURABILITÉ

Les dalles Ariostea sont réalisées en une unique masse, ingélive et résistante aux attaques chimiques et atmosphériques. Leur stabilité et leur durabilité est garantie dans le temps. Elles sont idéales quel que soit leur emploi et le type d'environnement intérieur ou extérieur puisqu'elles conservent leurs caractéristiques techniques et esthétiques et ne nécessitent aucun entretien particulier. Outre un véritable gain de temps, elles permettent de réaliser d'importantes économies d'énergie.

IMPERMÉABILITÉ ET PROPRIÉTÉ

Le coefficient d'absorption pratiquement nul rend les matériaux high-tech Ariostea quasiment imperméables aux tâches et à la

saleté ; il en préserve la beauté au fil du temps.

Ceci permet un entretien journalier plus facile, économique et écologique du revêtement de sol Ariostea et de réaliser des économies substantielles en termes de temps, d'énergie et d'argent.

NATURE HIGH-TECH

La technologie Ariostea est donc capable de renouer avec la continuité des matériaux dans l'histoire, la culture et le goût qui s'est développé au fil des siècles. Mais elle en optimise également les performances (grâce à l'innovation continue), en développant les potentialités d'application, les interprétations esthétiques et techniques de façon exponentielle.

Les caractéristiques techniques et esthétiques des dalles high-tech Ariostea sont uniformes, quelle que soit l'épaisseur choisie. Elles permettent les mêmes transformations des marbres, des bois et des pierres ornementales dont elles mettent en valeur la richesse chromatique et le veinage unique de notre matériau.

CONSTANCE QUALITATIVE

La gestion électronique informatisée du processus de production garantit des qualités structurelles constantes dans le temps. Les résultats esthétiques varient de façon naturelle, mais contrôlée.

Les solutions techniques innovantes permettent en fait d'obtenir des variations aléatoires des veines et de la tessiture chromatique, en évitant tout type de répétitivité : chaque dalle est différente des autres. C'est une pièce unique, avec un veinage unique qui traverse la dalle dans toute son épaisseur, exactement comme ce qui a été créé par la nature.

MONOCALIBRE

Les opérations d'équerrage et de rectification dans une dimension unique de fabrication (monocalibre) auxquelles sont soumis les produits high-tech d'Ariostea, quelle que soit leur finition, garantissent non seulement une constance qualitative dans les dimensions des produits fournis (en facilitant considérablement la conception et le travail de toutes les personnes impliquées), mais permettent également d'associer des surfaces et des matériaux différents.

Cette caractéristique qualitative permet en outre la modularité dans la pose, entre les différents formats disponibles. Elle bénéficie également de l'épaisseur uniforme entre les différents matériaux (monoépaisseur).

Par ailleurs, la pose est réalisable avec des joints très fins, ce qui permet d'obtenir, sur le plan esthétique, des résultats très appréciés.

PERSONNALISATION

Les compositions géométriques infinies, la possibilité de créer des éléments graphiques grâce à la technologie de l'hydrojet et de l'incision chromatique au laser, la richesse des éléments ornementaux et du très grand nombre de pièces spéciales proposées, font que les possibilités de personnalisation de chaque espace commercial, des plus vastes et fréquentés aux plus raffinés et exclusifs, sont presque illimitées.





←
OFFICES



ARIOSTEA
SHOWROOM







Ci sono momenti tecnologici in cui un prodotto segna il passo allo stato della tecnica modificando il nostro stile di vita. È stato così con l'avvento dell'automobile, della televisione, di internet o degli smartphone per esempio. Crediamo che ragionevolmente ed egualmente si possa guardare, con simile ammirazione, al salto tecnologico che ha consentito al settore ceramico di passare dai formati tradizionali a quelli giganti che contraddistinguono il progetto Ultra. La scala di grandezza dei materiali supera ora ampiamente i riferimenti antropometrici del Modulor teorizzato da Le Corbusier nel 1948, toccando i 3 metri di altezza e rapportandosi non più solo al fattore umano ma all'edificio nel suo complesso, consentendone la risoluzione dell'interfaccia esterna oltre alla vestizione degli spazi interni.

There are technological moments in which a product makes the leap to being state of the art and changes our life style. For example, it was so for the automobile, the television, the Internet and smartphones. We feel that you could reasonably and equally look, with similar admiration, to the technological leap that has allowed the ceramic sector to move on from its traditional sizes to giant ones, like those that distinguish the Ultra project. The scale of proportions is now far larger than the anthropometric reference points of the Modulor originally theorized by Le Corbusier in 1948. These reach 3 metres in height and relate not only to just the human factor, but to the building in its entirety allowing the resolution of the external interface as well as the dressing of the internal spaces.

ULTRA®
ARIOSTEA GREAT SURFACES

Es gibt Momente, in denen ein Produkt der modernen Technik weicht und so unseren Lebensstil verändert. Dies war ganz eklatant der Fall, als das Automobil, der Fernseher, Internet oder die modernen Smartphones erfunden wurden. Wir sind der Meinung, dass man auf gleiche Weise und mit fast ähnlicher Bewunderung den technischen Fortschritt betrachten kann, der es der Keramikindustrie ermöglicht hat, von den traditionellen Größen zu den gigantischen und großformatigen Platten zu wechseln, die unser Projekt Ultra auszeichnen. Die Größenordnung des Materials überragt bei Weitem das anthropometrische Proportions-System des von Le Corbusier im Jahr 1948 theoretisierten Modulors und passt sich mit seinen 3 Metern Höhe nicht nur dem Faktor Mensch an, sondern auch dem gesamten Gebäudekomplex, wodurch eine Auflösung der externen Schnittstelle ermöglicht wird, die weit über die einfache Verkleidung des Innenraums hinausgeht.

Il existe des moments technologiques où le produit marque le pas sur l'état de la technique, en modifiant notre style de vie. C'est ce qui est arrivé avec l'avènement de l'automobile, de la télévision, d'Internet ou des smartphones, par exemple. Nous pensons qu'il est possible d'étudier de manière raisonnable et égale, mais aussi avec une admiration semblable, les progrès technologiques qui ont permis au secteur de la céramique de passer des formats traditionnels aux formats immenses qui distinguent le projet Ultra. L'échelle de grandeur des matériaux dépasse désormais largement les références anthropométriques du Modulor théorisé par Le Corbusier en 1948, atteignant 3 mètres de hauteur et se rapportant non plus seulement au facteur humain, mais au bâtiment dans son intégralité, permettant la résolution de l'interface externe, ainsi que l'habillage des espaces internes.



ULTRA TECHNOLOGY PLUS



ULTRA SIZE

ULTRA con i suoi 4,50 m² è il nuovo punto di riferimento per i progettisti e per tutti gli interventi dove le dimensioni fanno la differenza.

With its area of 4,50 m², ULTRA is the new industry standard for project designers and for all projects where dimensions make the difference.

Mit seinen 4,50 m² ist ULTRA die neue Bezugsgröße für die Gestalter und für alle Gelegenheiten, bei denen die Maße den Unterschied bilden.

ULTRA et ses 4,50 m² est un nouveau point de référence pour les concepteurs et dans toutes les interventions où les dimensions font la différence.



TAILORED

ULTRA offre estrema flessibilità al progetto e la libertà di realizzare le tue idee senza vincoli di formato.

ULTRA offers unmatched project flexibility and the freedom to give concrete form to your ideas without being shackled by size.

ULTRA bietet höchste Flexibilität der Gestaltung und die Freiheit, Ideen zu entwickeln, ohne durch das Format eingeschränkt zu sein.

ULTRA offre une grande polyvalence dans la création de projet ainsi que la liberté de réaliser vos idées sans contraintes de format.



LIGHTEST

ULTRA con il suo spessore 6 mm nativo, garantisce leggerezza e resistenza per tutte le applicazioni, anche quelle a cui non avevi pensato

Thanks to its native 6 mm thickness, ULTRA provides lightness and strength in all applications - even the ones you'd never even imagined.

Mit seiner ursprünglichen Dicke von 6 mm garantiert ULTRA leichtes Gewicht und Widerstandsfähigkeit für alle Anwendungen, auch solchen, an die Sie vielleicht nicht gedacht haben.

ULTRA, aux épaisseurs de 6 mm à l'état natif, est un gage de légèreté et de résistance pour toutes les applications, même celles auxquelles vous n'aviez pas pensé.



300x150 / 120"x60"

150x150 / 60"x60"

150x75 / 60"x30"

75x75 / 30"x30"

75x37,5 / 30"x15"

300x150

2 STARTING SIZES

300x100 / 120"x40"

150x100 / 60"x40"

100x100 / 40"x40"

300x100





8 SIZES
10 COLLECTIONS
5 FINISHES
6mm THICKNESS



FINISHES



LUCIDATO SHINY



LEVIGATO SILK



SOFT



STRUCTURED



PRELUCIDATO

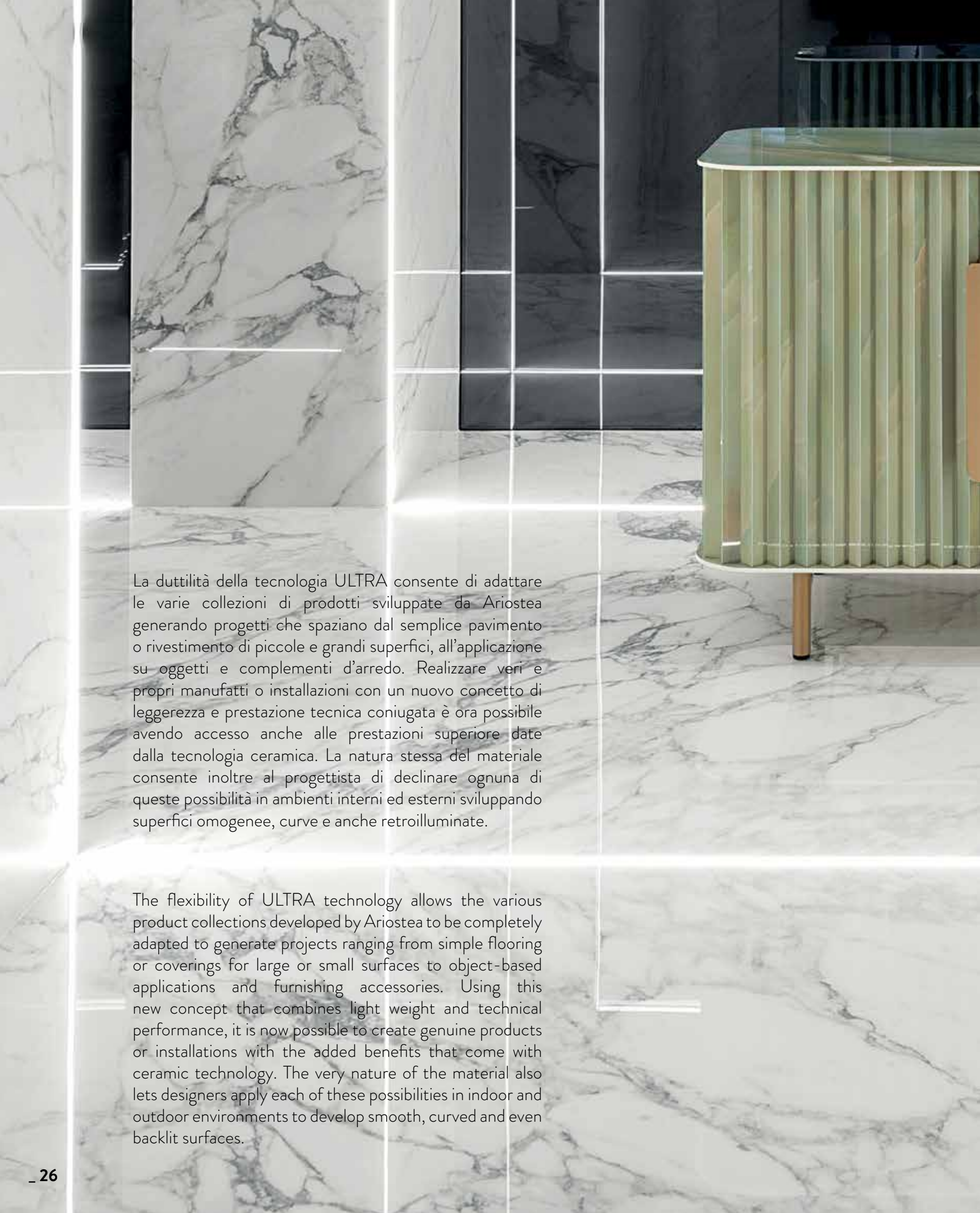

La duttilità della tecnologia ULTRA consente di adattare le varie collezioni di prodotti sviluppate da Ariostea generando progetti che spaziano dal semplice pavimento o rivestimento di piccole e grandi superfici, all'applicazione su oggetti e complementi d'arredo. Realizzare veri e propri manufatti o installazioni con un nuovo concetto di leggerezza e prestazione tecnica coniugata è ora possibile avendo accesso anche alle prestazioni superiori date dalla tecnologia ceramica. La natura stessa del materiale consente inoltre al progettista di declinare ognuna di queste possibilità in ambienti interni ed esterni sviluppando superfici omogenee, curve e anche retroilluminate.

The flexibility of ULTRA technology allows the various product collections developed by Ariostea to be completely adapted to generate projects ranging from simple flooring or coverings for large or small surfaces to object-based applications and furnishing accessories. Using this new concept that combines light weight and technical performance, it is now possible to create genuine products or installations with the added benefits that come with ceramic technology. The very nature of the material also lets designers apply each of these possibilities in indoor and outdoor environments to develop smooth, curved and even backlit surfaces.



APPLICATION **DESIGN**





Die Flexibilität der Technologie ULTRA erlaubt es, die verschiedenen Kollektionen von Ariostea aufeinander abzustimmen, und Projekte zu realisieren, die vom einfachen Bodenbelag oder der Wandverkleidung kleiner und großer Flächen bis zu Anwendungen für Objekte und Möbel reichen. Anspruchsvolle Arbeiten oder Installationen mit einem neuen Konzept, das geringes Gewicht und hohe technische Leistungen verbindet, sind jetzt möglich. Aufgrund der Keramiktechnologie sind dabei auch höhere Leistungen erreichbar.

Das Wesen des Materials selbst ermöglicht es dem Planer, jede dieser Möglichkeiten sowohl im Innen- als auch im Außenbereich auszuschöpfen, um so einheitliche durchgängige oder gewölbte Flächen oder Anwendungen mit Hintergrundbeleuchtung auszuführen.

La souplesse de la technologie ULTRA permet d'adapter les différentes collections développées par Ariostea en créant des produits qui vont du simple carrelage au revêtement de petites et grandes surfaces à l'application sur des objets et articles de décoration.

Il est désormais possible de réaliser de véritables articles manufacturés ou des installations avec un nouveau concept de légèreté, associé à une prestation technique, en accédant aussi aux prestations supérieures apportées par la technologie céramique.

De plus, la nature même du matériau permet au concepteur de décliner chacune de ces possibilités dans des espaces intérieurs et extérieurs, en réalisant des surfaces homogènes, courbes et même rétroéclairées.

APPLICATIONS



TOPS & KITCHEN

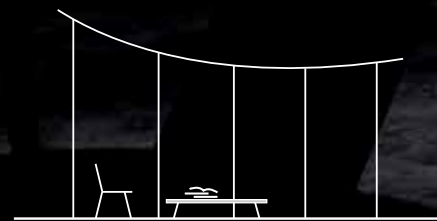

CURVED SURFACE



DOORS & SLIDING WALLS

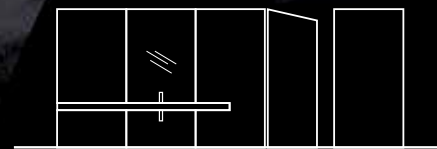

TOPS & BATHROOMS

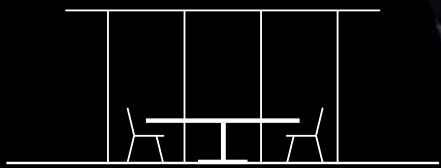

INTERIOR & DESIGN



FLOORS WALLS & STAIRS

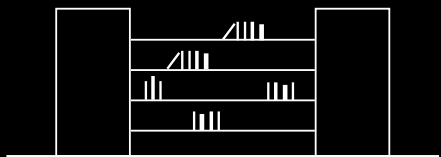

SHELVES & CONSOLE

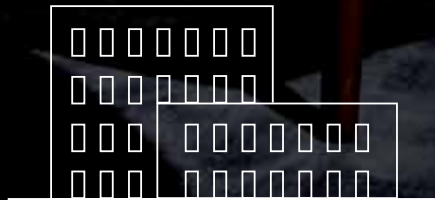

VENTILATED FAÇADE



6 mm

FULL-BODY
THICKNESS

SIZES
3000x1500 mm
3000x1000 mm



12 mm

FULL-BODY
THICKNESS

SIZE
3280x1540 mm



20 mm

FULL-BODY
THICKNESS

SIZE
3280x1540 mm



**TOPS &
KITCHEN**

TOPS & BATHROOMS







DOORS
WALLS & STAIRS





CURVED
SURFACES



ARIOSTEA ULTRA
HIDROFONE VOCE
GREAT SPEAKERS
26

57 8 5 6



INTERIOR DECORATION
& DESIGN





VENTILATED FAÇADE



SISTEMA
SAFETY CLIP
INVOLUCRO
A UMIDO

SAFETY CLIP
SYSTEM WET
ENVELOPES



SISTEMA
A CAPPOTTO
INVOLUCRO
A UMIDO

THERMAL
CLADDING SYSTEM
WET ENVELOPES



SISTEMA
MICRO
INVOLUCRO
A SECCO

MICRO SYSTEM
DRY ENVELOPES



FACCIATA
VENTILATA
INVOLUCRO
A SECCO

VENTILATED
FAÇADE DRY
ENVELOPES



SISTEMA
ULTRA FRAME
INVOLUCRO
A SECCO

ULTRA FRAME
SYSTEM
DRY ENVELOPES



SISTEMA
ULTRA LIGHT
INVOLUCRO
A SECCO

ULTRA LIGHT
SYSTEM DRY
ENVELOPES



BACKLIGHT

Lo spessore estremamente contenuto di 6 mm insieme all'evoluta tecnologia consentono ad alcuni prodotti Ultra di poter essere attraversate da un fascio luminoso di adeguata potenza ottenendo la traslucenza del materiale.

The extremely reduced 6mm thickness, together with the advanced Ultra technology, allows an appropriately powerful band of light to travel through the Ultra slabs and backlight the material.

Die auf 6 mm extreme beschränkte Dünne, gepaart mit der fortschrittlichen Ultra-Technik, erlaubt es den Platten Ultra von einem ausreichenden starken Lichtstrahl durchdrungen zu werden und so den Durchlichteffekt des Materials zu bieten.

L'épaisseur extrêmement réduite de 6 mm associée à la technologie évolutive, permettent à certains produits Ultra, d'être traversés par un faisceau lumineux, d'une puissance appropriée pour obtenir la translucidité du matériel.

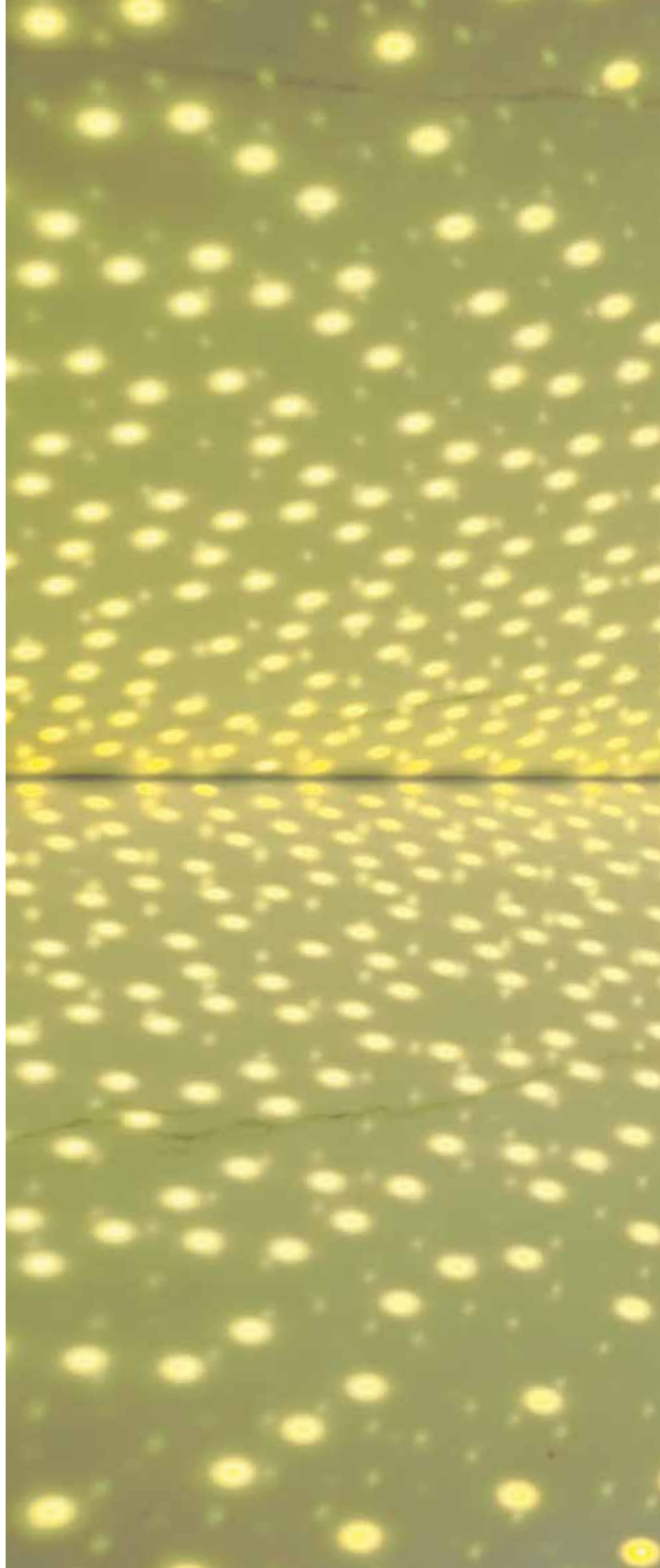

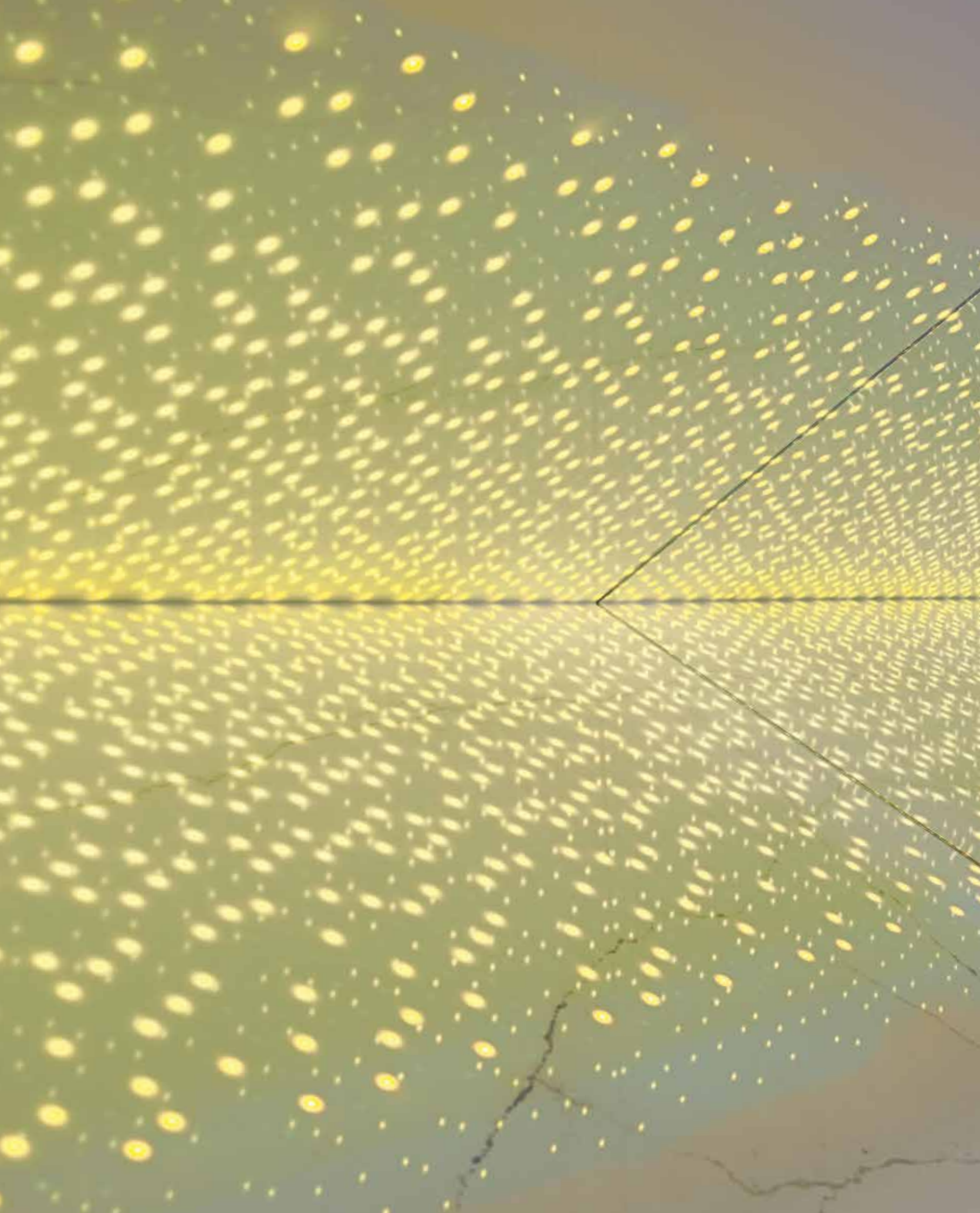



active-ceramic.it

ULTRA[®]

ARIOSTEA GREAT SURFACES

ACTIVE[™]

CLEAN AIR & ANTIBACTERIAL CERAMIC

ACTIVE: IL MATERIALE ECOATTIVO PER INTERNI ED ESTERNI

Active Clean Air & Antibacterial Ceramic™ è un prodotto fotocatalitico in grado di sfruttare tutte le proprietà dei materiali fotocatalitici:

- **Effetto Antibatterico:** Siamo costantemente in contatto con batteri, alcuni dei quali sono molto pericolosi per la nostra salute. ACTIVE è efficace al 99,99% su tutti i batteri, dai più comuni come *Escherichia Coli* ai più pericolosi come *Staphylococcus Aureus Methicillin-resistant* (MRSA – antibiotico resistente).
- **Effetto Anti-inquinamento:** Grazie al processo fotocatalitico, le sostanze inquinanti volatili vengono convertite in prodotti innocui, proprio in presenza di luce o umidità naturale o artificiale. L'effetto anti-inquinamento è stato dimostrato da test specifici eseguiti in laboratori accademici certificati; la formaldeide e gli ossidi di azoto sono stati scelti rispettivamente come molecole di riferimento dell'inquinamento indoor e outdoor.
- **Effetto Self-cleaning:** La sporcizia non aderisce grazie alle nuove proprietà idrofile della superficie fotocatalitica e la pulizia risulta più facile anche senza detergenti aggressivi (che sono essi stessi fonte di inquinamento), ma solo con acqua o saponi neutri. All'aperto, la pioggia è in grado di pulire le superfici mantenendo inalterati i colori originali e prevenendo le manutenzioni future.
- **Effetto Anti-odore:** le molecole organiche odorigene sono degradate e distrutte grazie alle proprietà fotocatalitiche delle superfici ecoattive, che eliminano i cattivi odori. Test di laboratorio su molecole fortemente odoranti, come il metilmercaptano (che di solito viene aggiunto a metano con un tipico odore forte di cavolo marcio) o alfa-pinene (la tipica fragranza di pino) hanno dimostrato la completa efficacia di ACTIVE nel degradare questo tipo di molecole.

IL NUOVO ACTIVE 2.0

Oltre alle proprietà e alle caratteristiche sopra elencate, oggi è disponibile il nuovo ACTIVE 2.0. Grazie all'uso del biossido di titanio drogato con argento, processo brevettato Iris Ceramica Group. Active 2.0 mantiene tutte le proprietà fotocatalitiche ma una maggiore efficienza rispetto al prodotto Active di prima generazione. Grazie alla presenza dell'argento, le nuove lastre ceramiche Active 2.0 sono antibatteriche anche in condizioni di scarsa illuminazione e al buio. Active 2.0 è attivo con tutti i tipi di batteri, anche su quelli *antibiotico-resistenti* (MRSA) molto pericolosi per l'uomo e purtroppo in continuo aumento in tutto il mondo. Unico materiale industriale al mondo, Active 2.0 possiede tutte le proprietà fotocatalitiche non solo con luci UV o solare, ma anche con luci LED.

ACTIVE: THE ECOACTIVE MATERIAL FOR INTERIOR AND EXTERIOR

Active Clean Air & Antibacterial Ceramic™ is a photocatalytic product able to activate all the properties of the photocatalytic materials:

- **Antibacterial effect:** We are constantly in contact with bacteria, some of which are dangerous for health. Active is 99,99% efficient on all bacteria, from the most common such as *Escherichia Coli* to the most dangerous such as *Staphylococcus Aureus Methicillin-resistant* (MRSA).
- **Anti-pollution effect:** thanks to the photocatalytic process, the volatile molecules of pollutants are converted into harmless substances, just in presence of natural or artificial light and humidity. The anti-pollution effect was proven by specific tests performed in certified academic laboratories; formaldehyde and nitrogen oxides were selected as reference molecules of the indoor and outdoor pollution respectively.
- **Self-cleaning effect:** Dirt does not adhere thanks to the new hydrophilic properties of the photocatalytic surface, and their cleaning will be easier even without aggressive cleaning agents (which are also a source of pollution), but just with water or neutral soaps. Outdoors, the rain is able to clean surfaces keeping the original colors unchanged and preventing next maintenance.
- **Anti-odor effect:** smelling organic molecules are degraded and destroyed thanks to the photocatalytic properties of the Active surfaces, which eliminate bad odors. Laboratory tests on strongly odorant molecules, such as methylmercaptan (which is usually added to methane and shows a typical strong smell of rotten cabbage) or alpha-pinene (the typical pine fragrance) proved the complete efficiency of Active in killing this kind of molecules.

THE NEW ACTIVE 2.0

New Active 2.0 is now available; in addition to the properties listed above it now counts on new features granted by a high-performant Titanium Dioxide fortified with Silver (patented technology by Iris Ceramica Group). Active 2.0 maintains all the photocatalytic properties of the first Active generation, increasing its efficiency through the presence of metals, which guarantee the following high performing features; Antibacterial activity in low or no - light conditions. Active 2.0 fights all kind of bacteria including the MRSA bacteria (*antibiotic-resistant*), which is worldwide increasing and dangerously affecting humans' health. Active 2.0, the unique material in the world with photocatalytic properties (as self-cleaning, anti-odor and anti-pollution), is efficient not only with UV or sunlight but also under LED lights.



design your slabs



chys

DESIGN YOUR SLABS

Design your slabs è un nuovo e rivoluzionario servizio tecnologico che permette di realizzare qualsiasi immagine o illustrazione su lastre Ultra. Un sistema digitale che sa fare grandi cose. proprio come te.

Dall'idea minimal al progetto più elaborato, tutto quello che può essere immaginato da progettisti e designer può diventare elemento di decoro su un materiale estremamente performante come la ceramica tecnica. Un servizio tagliato su misura per risultati grandiosi dalle misure più grandi a quelle più piccole dai formati tradizionali a quelli più innovativi il sistema Design Your Slabs decora ogni tipo di lastra per offrire una personalizzazione sempre unica.

Design Your Slabs is a new and revolutionary technological service that makes it possible to reproduce any image or illustration on Ultra Slabs. A digital system that can do great things. just like you.

From minimal looks to the most elaborate project, whatever architects and designers imagine can become a decorative element on an extremely performing material such as Ultra Slabs. A customized service for greatest results from largest to smallest sizes, from traditional to most innovative formats, Design Your Slabs decorates every kind of slab to offer a unique customization.









Mit unserem völlig neuartigen Technologieservice, Design your Slabs, können Bilder oder Illustrationen auf großen keramischen Formaten nachgebildet und dauerhaft aufgebracht werden.

Ein digitales System, das große Dinge tun kann, genau wie sie es können! Vom minimalistischen Stil bis zu ausgearbeiteten Projekten, alles was sich Architekten und Designer vorstellen können, ist ab sofort als dekoratives Element auf einem extrem leistungsstarken Material, wie unseren Ultra Fliesen, realisierbar. Eine massgeschneiderte Technologie für großartige Ergebnisse. Von großen bis zu kleineren Formaten, von traditionellen bis zu innovativen Formen. Design your Slabs ermöglicht jede Art von Dekor, auf jeder Platte und das zudem mit einer individuellen Gestaltung

Design your slabs représente un nouveau service technologique révolutionnaire qui permet de réaliser toute image ou illustration sur les dalles Ultra. Un système digital en mesure de réaliser de grandes choses. Tout comme toi.

De l'idée minimale au projet plus élaboré, tout ce qui peut être imaginé par les designers peut devenir un élément de décor sur un matériel extrêmement performant comme la céramique technique.

Un service sur mesure pour des résultats grandioses. À partir des mesures plus grandes à celles plus petites, dès formats traditionnels à ceux plus innovants, le système Dys décore toute typologie de dalle, afin d'offrir une personnalisation toujours unique.

ULTRA
 MARMI
 levigato silk
 lucidato shiny
 soft



ULTRA
 iCementi
 soft



ULTRA
 ONICI
 lucidato shiny
 levigato silk
 soft

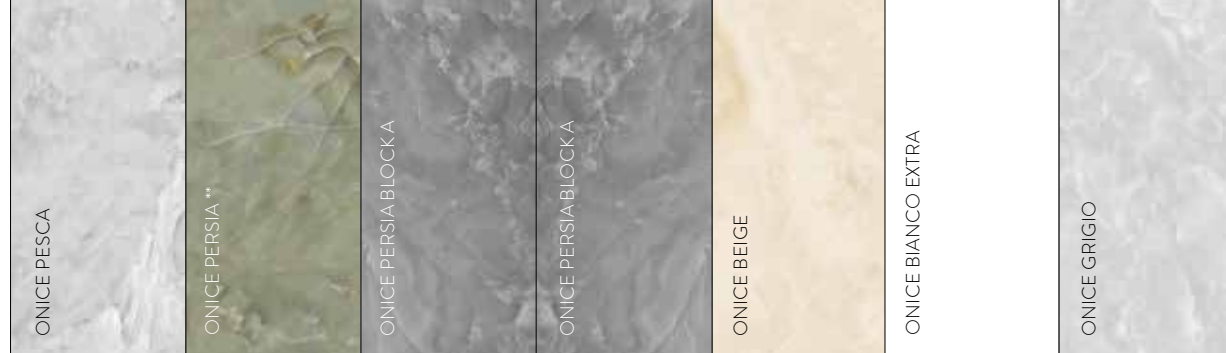

ULTRA
 CON.CREA.
 soft

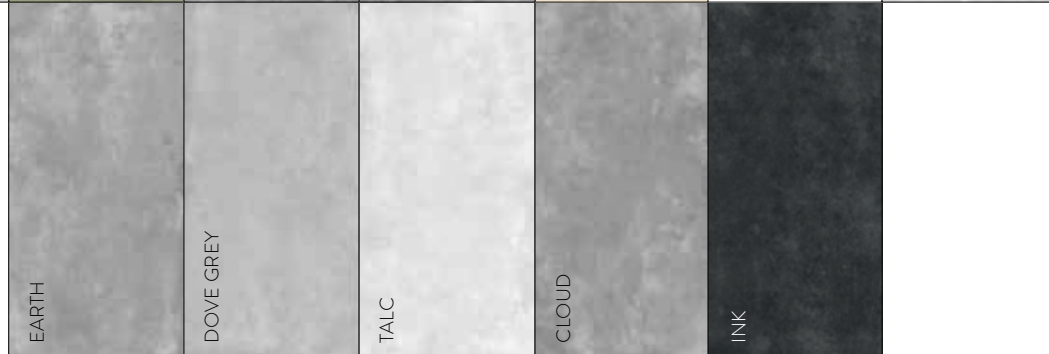

ONICE IVORY	GREY ONYX VEIN CUT	GREEN ONYX VEIN CUT	FIOR DI BOSCO	GREY MARBLE *	PORTE D'OR	SAHARA NOIR	ZEBRINO BLACK	NERO MARQUINIA	<p>U L T R A I R I D I U M lucidato shiny soft</p>	BIANCO	NERO
STATUARIO ALTISSIMO **	STATUARIO ALTISSIMO BLOCK A	STATUARIO ALTISSIMO BLOCK B	BIANCO COVELANO *	ARABESCATO STATUARIO **	ARABESCATO STATUARIO BLOCK A	ARABESCATO STATUARIO BLOCK B	CALACATTA MACCHIA VECCHIA **	CALACATTA MACCHIA VECCHIA BLOCK A	CALACATTA MACCHIA VECCHIA BLOCK B		

U L T R A
M E T A L
soft

GREY ZINC

BLUE ZINC

BROWN ZINC

GREY PLATE

BLACK PLATE

<p>ULTRA M A R M I lucidato shiny soft</p>	THASSOS	<p>ULTRA Resine soft</p>			CALCE	SILICIO	PIOMBO	EBANO					
<p>ULTRA IRIDIUM lucidato shiny soft</p>	BIANCO	NERO	<p>ULTRA TEKNO STONE soft</p>			LIGHT GREY	SMOKE	TAUPE	TOBACCO				
<p>ULTRA iCementi soft</p>	GRAPHITE	IRON	SILVER	<p>ULTRA CON.CREA. soft</p>			EARTH	CLOUD	TALC	DOVE GREY	INK		
<p>ULTRA Pietre soft structured prelucidato</p>	JERUSALEM LIMESTONE	AZUL BATEIG LIMESTONE	SAN VICENTE LIMESTONE	BASALTINA ANTRACITE	BASALTINA GREY	BASALTINA WHITE	BASALTINA SAND	BASALTINA MOKA					
<p>ULTRA METAL soft</p>	BROWN ZINC	GREY ZINC	BLUE ZINC	<p>ULTRA BLEND.HT levigato silk soft</p>				BL04	BL03	BL02	BL01	BL05	

SAPIENSTONE

dress your kitchen

328 x 154 cm
129" x 60"

non rettificato /
unrectified /
unrechtwinkling /
non rectifié

12mm

natural silky
polished

DARK MARQUINA

ARABESCATO

BIANCO LASA

CALACATTA STATUARIO

UNI ICE

B O O K
M A T C H
silky polished

CALACATTA STATUARIO
BLOCKA

CALACATTA STATUARIO
BLOCK B

WHITE CALACATTA
BLOCKA

WHITE CALACATTA
BLOCK B

- Disponibile solo per ordini a book-match
- Available only for book-match orders
- Ausschließlich für Book-Match-Bestellungen erhältlich
- Disponible uniquement pour les commandes à livre ouvert

natural

BASALT BLACK

BASALT CREAM

URBAN ANTRACITE

URBAN ARGENTO

natural

BROWN EARTH

SAND EARTH

GREY EARTH

LIGHT EARTH

natural
pre-polished

MALM GREY

MALM BLACK

natural

ROVERE BUCKSKIN

ROVERE BAIO

ULTRA[®]

ARIOSTEA GREAT SURFACES

MARMI

.....

RETTIFICATO MONOCALIBRO

RECTIFIED SINGLE-CALIBRE /
REKTIFIZIERT EINKALIBRIG /
RECTIFIÉ MONOCALIBRE

SPESSORE

THICKNESS / DICKE / ÉPAISSEUR

$\frac{\downarrow}{6\text{mm}} \uparrow$

FORMATI

SIZES / FORMATE / FORMATS

300 x 150 cm

120" x 60"



150 x 150 cm

60" x 60"

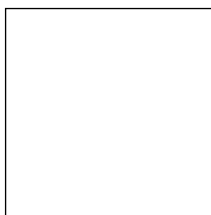

150 x 75 cm

60" x 30"



75 x 75 cm

30" x 30"



75 x 37,5 cm

30" x 15"

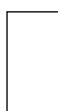

SUPERFICI / SURFACES / OBERFLÄCHEN / SURFACES

LUCIDATO SHINY

LEVIGATO SILK

FORMATI pag. 414

SIZES pag. 414 / FORMATE pag. 414 / FORMATS pag. 414

300 X 150



CALACATTA MACCHIA VECCHIA



ULTRA[®]

ARIOSTEA GREAT SURFACES

MARMI

.....

RETTIFICATO MONOCALIBRO

RECTIFIED SINGLE-CALIBRE /
REKTIFIZIERT EINKALIBRIG /
RECTIFIÉ MONOCALIBRE

SPESSORE

THICKNESS / DICKE / ÉPAISSEUR

▼
6mm
▲

FORMATI

SIZES / FORMATE / FORMATS

300 x 150 cm

120" x 60"

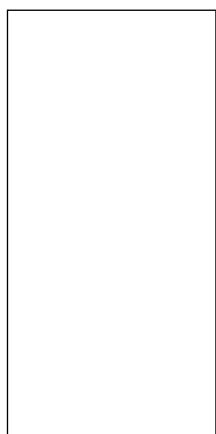

SUPERFICI / SURFACES /
OBERFLÄCHEN / SURFACES

LUCIDATO SHINY

FORMATI pag. 414

SIZES pag. 414 / FORMATE pag. 414 / FORMATS pag. 414

CALACATTA
MACCHIAVECCHIA
BLOCK A





MACCHIA APERTA /
BOOK MATCH /
MUSTERSYMMETRIE /
LIVRE OUVERT

“**Book match**” o “**macchia aperta**” sono termini con cui si indica la possibilità di posare lastre in continuità tra di loro ottenendo un effetto speculare della composizione. Il risultato estetico descritto, è particolarmente ricercato nell’ambiente dei marmisti ed è sinonimo di altissima qualità estrattiva in cava.

“**Book match**” is a term used to describe the technique of laying panels side by side to produce an effect where the pattern is mirrored. The aesthetic result achieved is particularly esteemed by those who work in the marble industry, and is synonymous with high quality extraction from the quarry.

“**Book Match**” oder **Mustersymmetrie** sind Begriffe, die auf die Möglichkeit hindeuten, Platten fortlaufend nebeneinander zu verlegen und so einen Spiegeleffekt der Gesamtanordnung zu erhalten. Das beschriebene ästhetische Ergebnis ist bei Marmorverarbeitern sehr begehrt und ein Synonym für hohe Abbaugüte im Marmorsteinbruch.

« **Book match** » ou « **livre ouvert** » sont des termes utilisés pour décrire la possibilité de poser des dalles en continuité entre elles afin d’obtenir un effet de composition en miroir. Le résultat esthétique à peine décrit est particulièrement recherché dans le domaine des travailleurs de marbre, et est synonyme de très de haute qualité d’exploitation minière dans la carrière.

CALACATTA
MACCHIA VECCHIA
BLOCK B

ULTRA[®]

ARIOSTEA GREAT SURFACES

MARMI

RETTIFICATO MONOCALIBRO

RECTIFIED SINGLE-CALIBRE /
REKTIFIZIERT EINKALIBRIG /
RECTIFIÉ MONOCALIBRE

SPESSORE

THICKNESS / DICKE / ÉPAISSEUR

6mm

FORMATI

SIZES / FORMATE / FORMATS

300 x 150 cm

120" x 60"



150 x 150 cm

60" x 60"



150 x 75 cm

60" x 30"

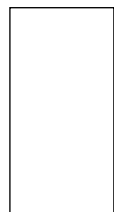

75 x 75 cm

30" x 30"

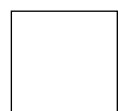

75 x 37,5 cm

30" x 15"



SUPERFICI / SURFACES / OBERFLÄCHEN / SURFACES

LUCIDATO SHINY

LEVIGATO SILK

FORMATI pag. 414

SIZES pag. 414 / FORMATE pag. 414 / FORMATS pag. 414

300X150

FIOR DI BOSCO



ULTRA[®]

ARIOSTEA GREAT SURFACES

MARMI

.....

RETTIFICATO MONOCALIBRO

RECTIFIED SINGLE-CALIBRE /
REKTIFIZIERT EINKALIBRIG /
RECTIFIÉ MONOCALIBRE

SPESSORE

THICKNESS / DICKE / ÉPAISSEUR

$\frac{\downarrow}{6\text{mm}} \uparrow$

FORMATI

SIZES / FORMATE / FORMATS

300 x 150 cm

120" x 60"



150 x 150 cm

60" x 60"

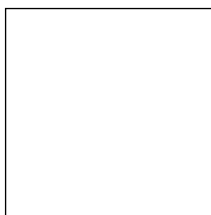

150 x 75 cm

60" x 30"



75 x 75 cm

30" x 30"



75 x 37,5 cm

30" x 15"



SUPERFICI / SURFACES / OBERFLÄCHEN / SURFACES

LUCIDATO SHINY

LEVIGATO SILK

FORMATI pag. 414

SIZES pag. 414 / FORMATE pag. 414 / FORMATS pag. 414

300 X 150



AZUL MACAUBAS



ULTRA[®]

ARIOSTEA GREAT SURFACES

MARMI

RETTIFICATO MONOCALIBRO

RECTIFIED SINGLE-CALIBRE /
REKTIFIZIERT EINKALIBRIG /
RECTIFIÉ MONOCALIBRE

SPESSORE

THICKNESS / DICKE / ÉPAISSEUR

6mm

FORMATI

SIZES / FORMATE / FORMATS

300 x 150 cm

120" x 60"

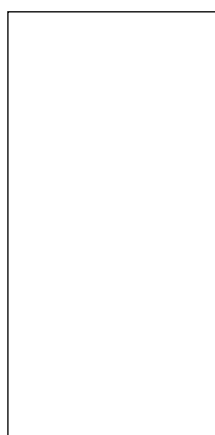

150 x 150 cm

60" x 60"



150 x 75 cm

60" x 30"



75 x 75 cm

30" x 30"

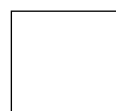

75 x 37,5 cm

30" x 15"



SUPERFICI / SURFACES / OBERFLÄCHEN / SURFACES

LUCIDATO SHINY

LEVIGATO SILK

FORMATI pag. 414

SIZES pag. 414 / FORMATE pag. 414 / FORMATS pag. 414

300 X 150

SAHARA NOIR



ULTRA[®]

ARIOSTEA GREAT SURFACES

MARMI

RETTIFICATO MONOCALIBRO

RECTIFIED SINGLE-CALIBRE /
REKTIFIZIERT EINKALIBRIG /
RECTIFIÉ MONOCALIBRE

SPESSORE

THICKNESS / DICKE / ÉPAISSEUR

▼
6mm
▲

FORMATI

SIZES / FORMATE / FORMATS

300 x 150 cm
120" x 60"

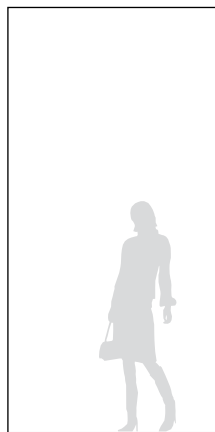

150 x 150 cm
60" x 60"

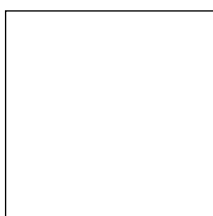

75 x 75 cm
30" x 30"



150 x 75 cm
60" x 30"

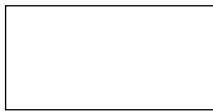

75 x 37,5 cm
30" x 15"



SUPERFICI / SURFACES / OBERFLÄCHEN / SURFACES

LUCIDATO SHINY
LEVIGATO SILK

FORMATI pag. 414

SIZES pag. 414 / FORMATE pag. 414 / FORMATS pag. 414

DARK MARQUINA

SAPIENSTONE

dress your kitchen

NON RETTIFICATO / UNRECTIFIED /
UNRECHTWINKELING / NON RECTIFIÉ

FORMATI /
SIZES /
FORMATE /
FORMATS

328 x 154 cm
129" x 60"

SPESSORE /
THICKNESS /
DICKE /
ÉPAISSEUR

▼
12mm
▲

SUPERFICI /
SURFACES /
OBERFLÄCHEN /
SURFACES

**SILKY /
POLISHED**

FORMATI pag. 416 / SIZES pag. 416 / FORMATE pag. 416 / FORMATS pag. 416

300X150

NERO MARQUINIA

ULTRA[®]

ARIOSTEA GREAT SURFACES

MARMI

.....

RETTIFICATO MONOCALIBRO

RECTIFIED SINGLE-CALIBRE /
REKTIFIZIERT EINKALIBRIG /
RECTIFIÉ MONOCALIBRE

SPESSORE

THICKNESS / DICKE / ÉPAISSEUR

▼
6mm
▲

FORMATI

SIZES / FORMATE / FORMATS

300 x 150 cm

120" x 60"



150 x 150 cm

60" x 60"



150 x 75 cm

60" x 30"



75 x 75 cm

30" x 30"

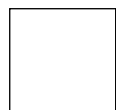

75 x 37,5 cm

30" x 15"



SUPERFICI / SURFACES / OBERFLÄCHEN / SURFACES

LUCIDATO SHINY

LEVIGATO SILK

FORMATI pag. 414

SIZES pag. 414 / FORMATE pag. 414 / FORMATS pag. 414

300 X 150



BIANCO CARRARA



ULTRA[®]

ARIOSTEA GREAT SURFACES

MARMI

RETTIFICATO MONOCALIBRO

RECTIFIED SINGLE-CALIBRE /
REKTIFIZIERT EINKALIBRIG /
RECTIFIÉ MONOCALIBRE

SPESSORE

THICKNESS / DICKE / ÉPAISSEUR

▼
6mm
▲

FORMATI

SIZES / FORMATE / FORMATS

300 x 150 cm

120" x 60"

150 x 150 cm

60" x 60"

75 x 75 cm

30" x 30"

150 x 75 cm

60" x 30"

75 x 37,5 cm

30" x 15"

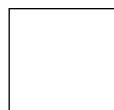
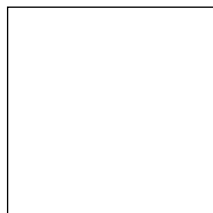
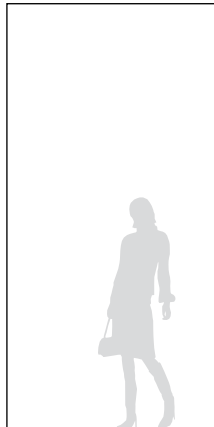

SUPERFICI / SURFACES / OBERFLÄCHEN / SURFACES

LUCIDATO SHINY

LEVIGATO SILK

FORMATI pag. 414

SIZES pag. 414 / FORMATE pag. 414 / FORMATS pag. 414

WHITE CALACATTA

MACCHIA APERTA / BOOK MATCH /
MUSTERSYMMETRIE / LIVRE OUVERT

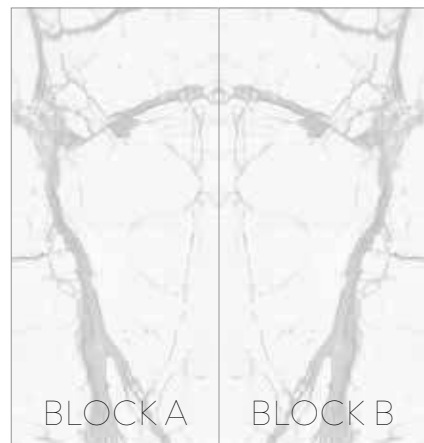

SAPIENSTONE

dress your kitchen

NON RETTIFICATO /
UNRECTIFIED /
UNRECHTWINKELING /
NON RECTIFIÉ

FORMATI / **328 x 154 cm**
SIZES /
FORMATE / **129" x 60"**
FORMATS

SPESSORE / **12mm** **20mm**
THICKNESS /
DICKE /
ÉPAISSEUR

SUPERFICI / **SILKY**
SURFACES / **POLISHED**
OBERFLÄCHEN /
SURFACES

FORMATI pag. 416 / SIZES pag. 416 /
FORMATE pag. 416 / FORMATS pag. 416

300 X 150

BIANCO CALACATTA



ULTRA®

ARIOSTEA GREAT SURFACES

MARMI

RETTIFICATO MONOCALIBRO

RECTIFIED SINGLE-CALIBRE /
REKTIFIZIERT EINKALIBRIG /
RECTIFIÉ MONOCALIBRE

SPESSORE

THICKNESS / DICKE / ÉPAISSEUR

▼
6mm
▲

FORMATI

SIZES / FORMATE / FORMATS

300 x 150 cm

120" x 60"

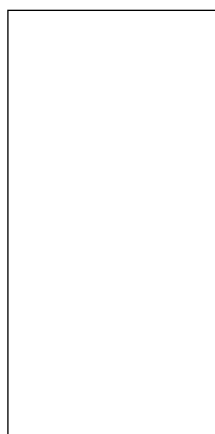

150 x 150 cm

60" x 60"

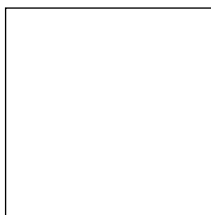

150 x 75 cm

60" x 30"



75 x 75 cm

30" x 30"

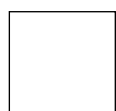

75 x 37,5 cm

30" x 15"



SUPERFICI / SURFACES / OBERFLÄCHEN / SURFACES

LUCIDATO SHINY

FORMATI pag. 414

SIZES pag. 414 / FORMATE pag. 414 / FORMATS pag. 414

300 X 150



CALACATTA LINCOLN



ULTRA[®]

ARIOSTEA GREAT SURFACES

MARMI

.....

RETTIFICATO MONOCALIBRO

RECTIFIED SINGLE-CALIBRE /
REKTIFIZIERT EINKALIBRIG /
RECTIFIÉ MONOCALIBRE

SPESSORE

THICKNESS / DICKE / ÉPAISSEUR

▼
6mm
▲

FORMATI

SIZES / FORMATE / FORMATS

300 x 150 cm

120" x 60"



150 x 150 cm

60" x 60"

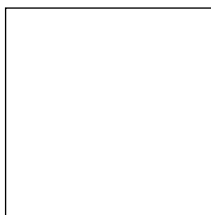

150 x 75 cm

60" x 30"



75 x 75 cm
30" x 30"

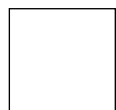

75 x 37,5 cm
30" x 15"

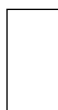

SUPERFICI / SURFACES / OBERFLÄCHEN / SURFACES

LUCIDATO SHINY

SOFT

FORMATI pag. 414

SIZES pag. 414 / FORMATE pag. 414 / FORMATS pag. 414

300 X 150

ULTRA®

ARIOSTEA GREAT SURFACES

MARMI

.....

RETTIFICATO MONOCALIBRO

RECTIFIED SINGLE-CALIBRE /
REKTIFIZIERT EINKALIBRIG /
RECTIFIÉ MONOCALIBRE

SPESSORE

THICKNESS / DICKE / ÉPAISSEUR

6mm

FORMATI

SIZES / FORMATE / FORMATS

300 x 150 cm

120" x 60"

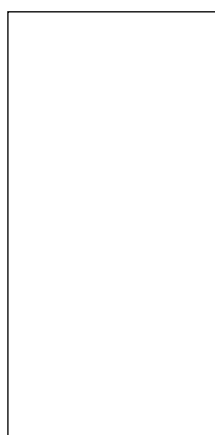

150 x 150 cm

60" x 60"

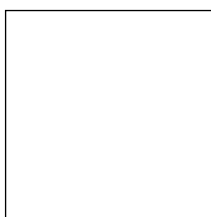

150 x 75 cm

60" x 30"



75 x 75 cm

30" x 30"



75 x 37,5 cm

30" x 15"

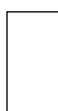

SUPERFICI / SURFACES / OBERFLÄCHEN / SURFACES

LUCIDATO SHINY

FORMATI pag. 414

SIZES pag. 414 / FORMATE pag. 414 / FORMATS pag. 414

300 X 150



ULTRA[®]

ARIOSTEA GREAT SURFACES

MARMI

RETTIFICATO MONOCALIBRO

RECTIFIED SINGLE-CALIBRE /
REKTIFIZIERT EINKALIBRIG /
RECTIFIÉ MONOCALIBRE

SPESSORE

THICKNESS / DICKE / ÉPAISSEUR

6mm

FORMATI

SIZES / FORMATE / FORMATS

300 x 150 cm

120" x 60"

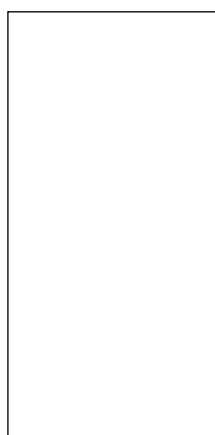

150 x 150 cm

60" x 60"

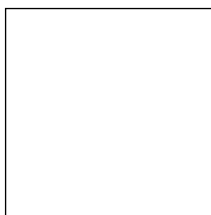

150 x 75 cm

60" x 30"



75 x 75 cm

30" x 30"



75 x 37,5 cm

30" x 15"



SUPERFICI / SURFACES / OBERFLÄCHEN / SURFACES

LUCIDATO SHINY

FORMATI pag. 414

SIZES pag. 414 / FORMATE pag. 414 / FORMATS pag. 414

300 x 150



PORTE D'OR

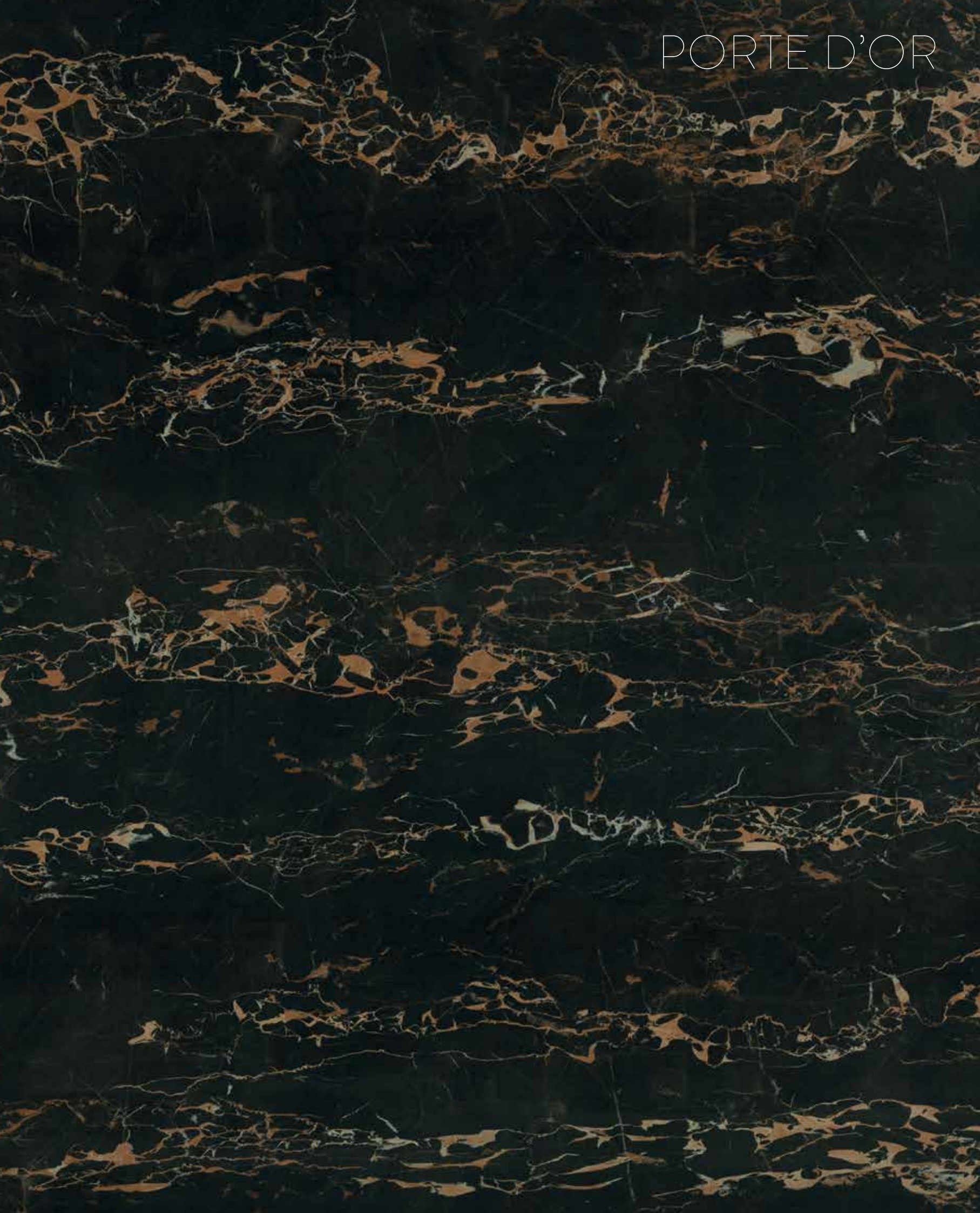

ULTRA[®]

ARIOSTEA GREAT SURFACES

MARMI

.....

RETTIFICATO MONOCALIBRO

RECTIFIED SINGLE-CALIBRE /
REKTIFIZIERT EINKALIBRIG /
RECTIFIÉ MONOCALIBRE

SPESSORE

THICKNESS / DICKE / ÉPAISSEUR

▼
6mm
▲

FORMATI

SIZES / FORMATE / FORMATS

150 x 150 cm

60" x 60"

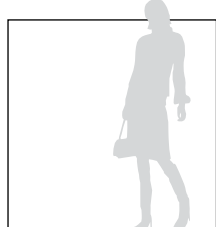

150 x 75 cm
60" x 30"



75 x 75 cm
30" x 30"

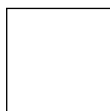

75 x 37,5 cm
30" x 15"

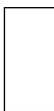

SUPERFICI / SURFACES / OBERFLÄCHEN / SURFACES

LUCIDATO SHINY

SOFT

FORMATI pag. 414

SIZES pag. 414 / FORMATE pag. 414 / FORMATS pag. 414



ARABESCATO

SAPIENSTONE

dress your kitchen

NON RETTIFICATO / UNRECTIFIED /
UNRECHTWINKELING / NON RECTIFIÉ

FORMATI /
SIZES /
FORMATE /
FORMATS

328 x 154 cm
129" x 60"

SPESSORE /
THICKNESS /
DICKE /
ÉPAISSEUR

▼
12mm
▲

SUPERFICI /
SURFACES /
OBERFLÄCHEN /
SURFACES

**NATURAL /
POLISHED**

FORMATI pag. 416 / SIZES pag. 416 / FORMATE pag. 416 / FORMATS pag. 416

ARABESCATO STATUARIO



ULTRA[®]

ARIOSTEA GREAT SURFACES

MARMI

.....

RETTIFICATO MONOCALIBRO

RECTIFIED SINGLE-CALIBRE /
REKTIFIZIERT EINKALIBRIG /
RECTIFIÉ MONOCALIBRE

SPESSORE

THICKNESS / DICKE / ÉPAISSEUR

▼
6mm
▲

FORMATI

SIZES / FORMATE / FORMATS

300 x 150 cm

120" x 60"

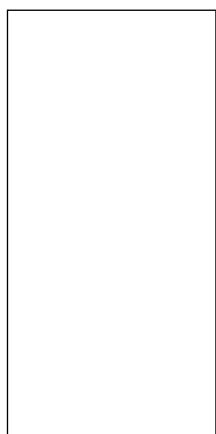

SUPERFICI / SURFACES /
OBERFLÄCHEN / SURFACES

LUCIDATO SHINY
SOFT

FORMATI pag. 414

SIZES pag. 414 / FORMATE pag. 414 / FORMATS pag. 414

300 X 150

ARABESCATO STATUARIO BLOCK A



A large, vertical image of a marble slab with the Arabescato Statuario pattern. The pattern consists of irregular, light-colored (cream and beige) veins and spots set against a darker, greyish-blue background. The overall appearance is organic and flowing.

MACCHIA APERTA /
BOOK MATCH /
MUSTERSYMMETRIE /
LIVRE OUVERT

“**Book match**” o “**macchia aperta**” sono termini con cui si indica la possibilità di posare lastre in continuità tra di loro ottenendo un effetto speculare della composizione. Il risultato estetico descritto, è particolarmente ricercato nell’ambiente dei marmisti ed è sinonimo di altissima qualità estrattiva in cava.

“**Book match**” is a term used to describe the technique of laying panels side by side to produce an effect where the pattern is mirrored. The aesthetic result achieved is particularly esteemed by those who work in the marble industry, and is synonymous with high quality extraction from the quarry.

“**Book Match**” oder **Mustersymmetrie** sind Begriffe, die auf die Möglichkeit hindeuten, Platten fortlaufend nebeneinander zu verlegen und so einen Spiegeleffekt der Gesamtanordnung zu erhalten. Das beschriebene ästhetische Ergebnis ist bei Marmorverarbeitern sehr begehrt und ein Synonym für hohe Abbaugüte im Marmorsteinbruch.

« **Book match** » ou « **livre ouvert** » sont des termes utilisés pour décrire la possibilité de poser des dalles en continuité entre elles afin d’obtenir un effet de composition en miroir. Le résultat esthétique à peine décrit est particulièrement recherché dans le domaine des travailleurs de marbre, et est synonyme de très de haute qualité d’exploitation minière dans la carrière.

ARABESCATO
STATUARIO
BLOCK B

ULTRA[®]

ARIOSTEA GREAT SURFACES

MARMI

.....

RETTIFICATO MONOCALIBRO

RECTIFIED SINGLE-CALIBRE /
REKTIFIZIERT EINKALIBRIG /
RECTIFIÉ MONOCALIBRE

SPESSORE

THICKNESS / DICKE / ÉPAISSEUR

▼
6mm
▲

FORMATI

SIZES / FORMATE / FORMATS

300 x 150 cm

120" x 60"

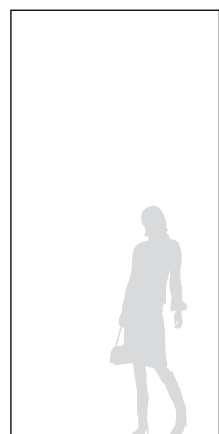

300 x 100 cm

120" x 40"

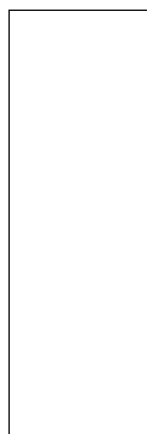

150 x 150 cm

60" x 60"



150 x 100 cm

60" x 40"

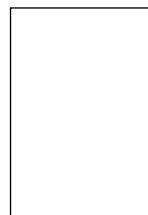

150 x 75 cm

60" x 30"

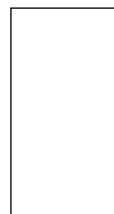

100 x 100 cm

40" x 40"



75 x 75 cm

30" x 30"

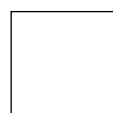

75 x 37,5 cm

30" x 15"



SUPERFICI / SURFACES / OBERFLÄCHEN / SURFACES

LUCIDATO SHINY

SOFT

FORMATI pag. 414

SIZES pag. 414 / FORMATE pag. 414 / FORMATS pag. 414

300 X 150

METRO

ULTRA TECHNOLOGY by ARIOSTEA HIGH-TECH

THASSOS

ULTRA[®]

ARIOSTEA GREAT SURFACES

MARMI

.....

RETTIFICATO MONOCALIBRO

RECTIFIED SINGLE-CALIBRE /
REKTIFIZIERT EINKALIBRIG /
RECTIFIÉ MONOCALIBRE

SPESSORE

THICKNESS / DICKE / ÉPAISSEUR

▼
6mm
▲

FORMATI

SIZES / FORMATE / FORMATS

300 x 150 cm

120" x 60"

150 x 150 cm

60" x 60"

75 x 75 cm

30" x 30"

150 x 75 cm

60" x 30"

75 x 37,5 cm

30" x 15"

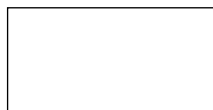
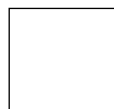
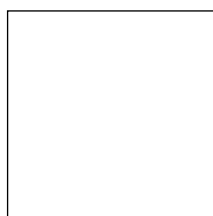
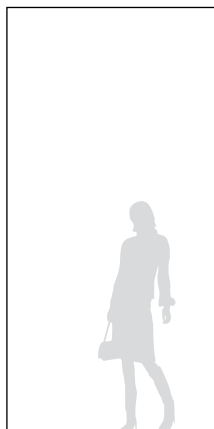

SUPERFICI / SURFACES / OBERFLÄCHEN / SURFACES

LUCIDATO SHINY

SOFT

FORMATI pag. 414

SIZES pag. 414 / FORMATE pag. 414 / FORMATS pag. 414



CALACATTA STATUARIO

SAPIENSTONE

dress your kitchen

NON RETTIFICATO / UNRECTIFIED /
UNRECHTWINKELING / NON RECTIFIÉ

FORMATI /
SIZES /
FORMATE /
FORMATS

328 x 154 cm
129" x 60"

SPESSORE /
THICKNESS /
DICKE /
ÉPAISSEUR

▼
12mm
▲

SUPERFICI /
SURFACES /
OBERFLÄCHEN /
SURFACES

**NATURAL /
POLISHED**

FORMATI pag. 416 / SIZES pag. 416 / FORMATE pag. 416 / FORMATS pag. 416

300X150

STATUARIO ALTISSIMO



ULTRA[®]

ARIOSTEA GREAT SURFACES

MARMI

.....

RETTIFICATO MONOCALIBRO

RECTIFIED SINGLE-CALIBRE /
REKTIFIZIERT EINKALIBRIG /
RECTIFIÉ MONOCALIBRE

SPESSORE

THICKNESS / DICKE / ÉPAISSEUR

▼
6mm
▲

FORMATI

SIZES / FORMATE / FORMATS

300 x 150 cm

120" x 60"

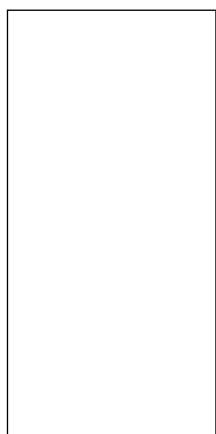

SUPERFICI / SURFACES /
OBERFLÄCHEN / SURFACES

LUCIDATO SHINY
SOFT

FORMATI pag. 414

SIZES pag. 414 / FORMATE pag. 414 / FORMATS pag. 414

300 X 150

STATUARIO ALTISSIMO BLOCK A

MACCHIA APERTA /
BOOK MATCH /
MUSTERSYMMETRIE /
LIVRE OUVERT

“Book match” o “macchia aperta” sono termini con cui si indica la possibilità di posare lastre in continuità tra di loro ottenendo un effetto speculare della composizione. Il risultato estetico descritto, è particolarmente ricercato nell’ambiente dei marmisti ed è sinonimo di altissima qualità estrattiva in cava.

“Book match” is a term used to describe the technique of laying panels side by side to produce an effect where the pattern is mirrored. The aesthetic result achieved is particularly esteemed by those who work in the marble industry, and is synonymous with high quality extraction from the quarry.

“Book Match” oder **Mustersymmetrie** sind Begriffe, die auf die Möglichkeit hindeuten, Platten fortlaufend nebeneinander zu verlegen und so einen Spiegeleffekt der Gesamtanordnung zu erhalten. Das beschriebene ästhetische Ergebnis ist bei Marmorverarbeitern sehr begehrt und ein Synonym für hohe Abbaugüte im Marmorsteinbruch.

« Book match » ou « livre ouvert » sont des termes utilisés pour décrire la possibilité de poser des dalles en continuité entre elles afin d’obtenir un effet de composition en miroir. Le résultat esthétique à peine décrit est particulièrement recherché dans le domaine des travailleurs de marbre, et est synonyme de très de haute qualité d’exploitation minière dans la carrière.

CALACATTA
STATUARIO

SAPIENSTONE

dress your kitchen

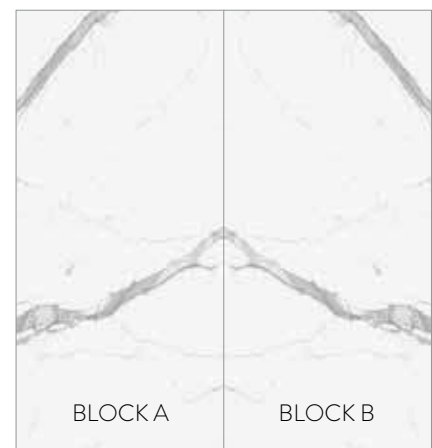

STATUARIO
ALTISSIMO
BLOCK B

NON RETTIFICATO / UNRECTIFIED /
UNRECHTWINKELING / NON RECTIFIÉ

FORMATI /
SIZES /
FORMATE /
FORMATS

328 x 154 cm
129” x 60”

SPESSORE /
THICKNESS /
DICKE /
ÉPAISSEUR

12mm

SUPERFICI /
SURFACES /
OBERFLÄCHEN /
SURFACES

**SILKY /
POLISHED**

FORMATI pag. 416 / SIZES pag. 416 / FORMATE pag. 416 / FORMATS pag. 416

ULTRA[®]

ARIOSTEA GREAT SURFACES

MARMI

.....

RETTIFICATO MONOCALIBRO

RECTIFIED SINGLE-CALIBRE /
REKTIFIZIERT EINKALIBRIG /
RECTIFIÉ MONOCALIBRE

SPESSORE

THICKNESS / DICKE / ÉPAISSEUR

▼
6mm
▲

FORMATI

SIZES / FORMATE / FORMATS

300 x 150 cm

120" x 60"

150 x 150 cm

60" x 60"

75 x 75 cm

30" x 30"

150 x 75 cm

60" x 30"

75 x 37,5 cm

30" x 15"

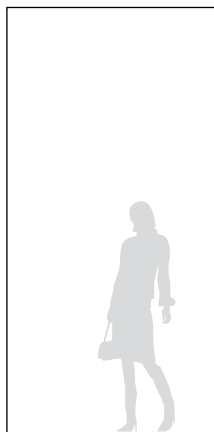

SUPERFICI / SURFACES / OBERFLÄCHEN / SURFACES

LUCIDATO SHINY

SOFT

FORMATI pag. 414

SIZES pag. 414 / FORMATE pag. 414 / FORMATS pag. 414



BIANCO LASA

SAPIENSTONE

dress your kitchen

NON RETTIFICATO / UNRECTIFIED /
UNRECHTWINKELIG / NON RECTIFIÉ

FORMATI /
SIZES /
FORMATE /
FORMATS

328 x 154 cm
129" x 60"

SPESSORE /
THICKNESS /
DICKE /
ÉPAISSEUR

▼
12mm
▲

SUPERFICI /
SURFACES /
OBERFLÄCHEN /
SURFACES

NATURAL /
POLISHED

FORMATI pag. 416 / SIZES pag. 416 / FORMATE pag. 416 / FORMATS pag. 416

300 X 150

BIANCO COVELANO



ULTRA®

ARIOSTEA GREAT SURFACES

MARMI

.....

RETTIFICATO MONOCALIBRO

RECTIFIED SINGLE-CALIBRE /
REKTIFIZIERT EINKALIBRIG /
RECTIFIÉ MONOCALIBRE

SPESSORE

THICKNESS / DICKE / ÉPAISSEUR

▼
6mm
▲

FORMATI

SIZES / FORMATE / FORMATS

300 x 150 cm

120" x 60"

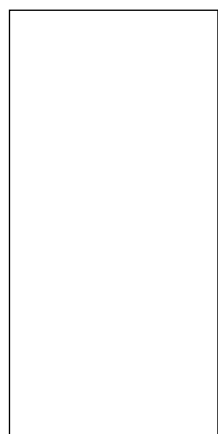

150 x 150 cm

60" x 60"

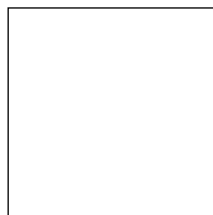

150 x 75 cm

60" x 30"

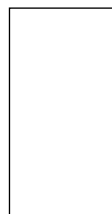

75 x 75 cm

30" x 30"

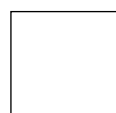

75 x 37,5 cm

30" x 15"



SUPERFICI / SURFACES / OBERFLÄCHEN / SURFACES

LUCIDATO SHINY

FORMATI pag. 414

SIZES pag. 414 / FORMATE pag. 414 / FORMATS pag. 414

300X150



ESTREMOZ

ULTRA®

ARIOSTEA GREAT SURFACES

MARMI

RETTIFICATO MONOCALIBRO

RECTIFIED SINGLE-CALIBRE /
REKTIFIZIERT EINKALIBRIG /
RECTIFIÉ MONOCALIBRE

SPESSORE

THICKNESS / DICKE / ÉPAISSEUR

▼
6mm
▲

FORMATI

SIZES / FORMATE / FORMATS

300 x 150 cm

120" x 60"

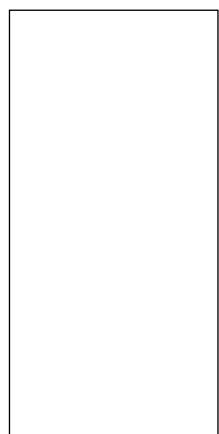

150 x 150 cm

60" x 60"



150 x 75 cm

60" x 30"

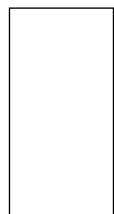

75 x 75 cm

30" x 30"

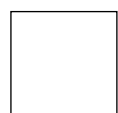

75 x 37,5 cm

30" x 15"



SUPERFICI / SURFACES / OBERFLÄCHEN / SURFACES

LUCIDATO SHINY

SOFT

FORMATI pag. 414

SIZES pag. 414 / FORMATE pag. 414 / FORMATS pag. 414

300X150



STATUARIO ULTRA

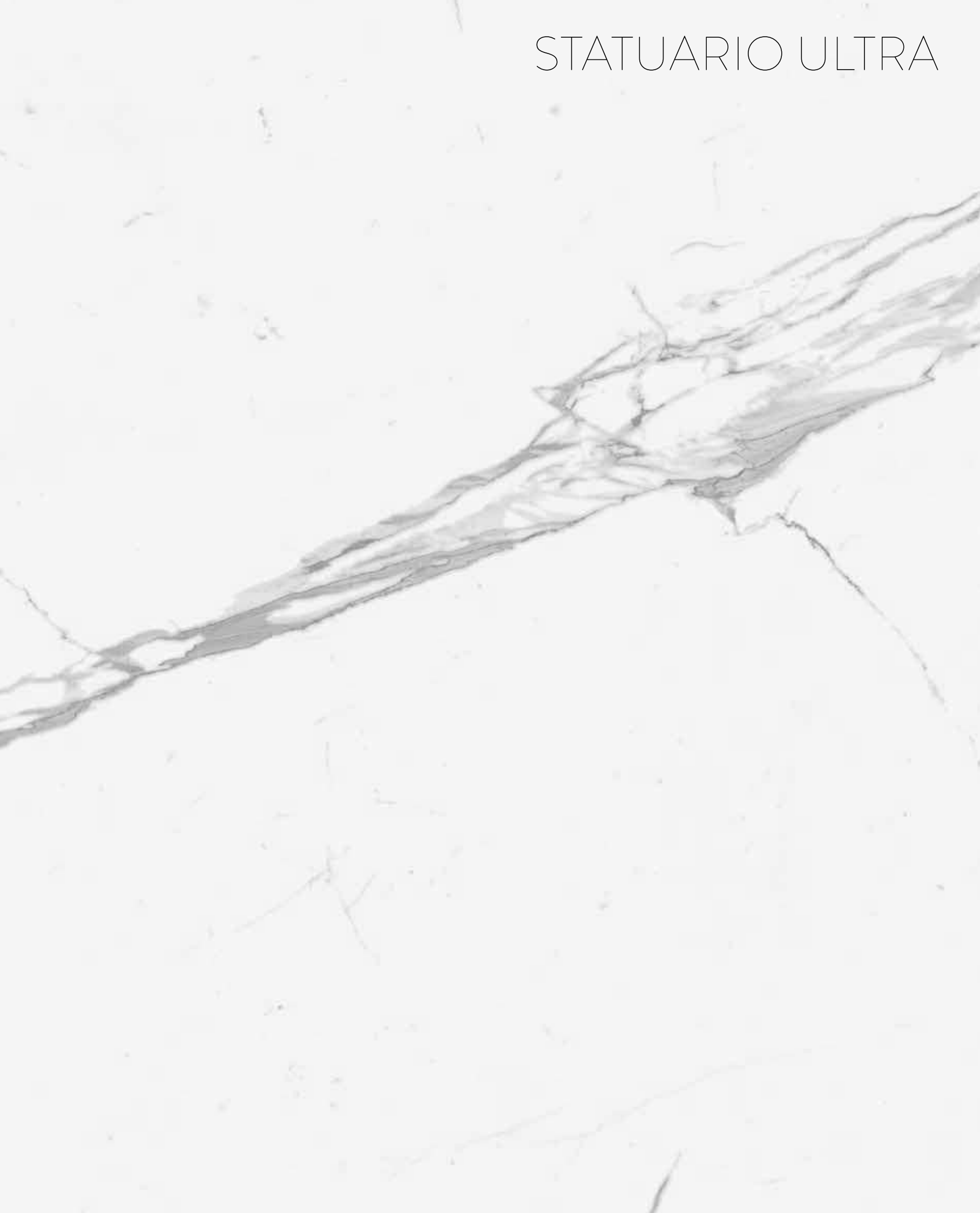

ULTRA[®]

ARIOSTEA GREAT SURFACES

MARMI

.....

RETTIFICATO MONOCALIBRO

RECTIFIED SINGLE-CALIBRE /
REKTIFIZIERT EINKALIBRIG /
RECTIFIÉ MONOCALIBRE

SPESSORE

THICKNESS / DICKE / ÉPAISSEUR

▼
6mm
▲

FORMATI

SIZES / FORMATE / FORMATS

300 x 150 cm

120" x 60"

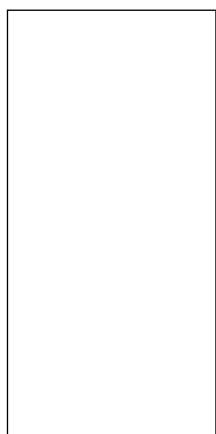

SUPERFICI / SURFACES /
OBERFLÄCHEN / SURFACES

LUCIDATO SHINY

FORMATI pag. 414

SIZES pag. 414 / FORMATE pag. 414 / FORMATS pag. 414

300 X 150

STATUARIO ULTRA BLOCK A



MACCHIA APERTA /
BOOK MATCH /
MUSTERSYMMETRIE /
LIVRE OUVERT

“**Book match**” o “**macchia aperta**” sono termini con cui si indica la possibilità di posare lastre in continuità tra di loro ottenendo un effetto speculare della composizione. Il risultato estetico descritto, è particolarmente ricercato nell’ambiente dei marmisti ed è sinonimo di altissima qualità estrattiva in cava.

“**Book match**” is a term used to describe the technique of laying panels side by side to produce an effect where the pattern is mirrored. The aesthetic result achieved is particularly esteemed by those who work in the marble industry, and is synonymous with high quality extraction from the quarry.

“**Book Match**” oder **Mustersymmetrie** sind Begriffe, die auf die Möglichkeit hindeuten, Platten fortlaufend nebeneinander zu verlegen und so einen Spiegeleffekt der Gesamtanordnung zu erhalten. Das beschriebene ästhetische Ergebnis ist bei Marmorverarbeitern sehr begehrt und ein Synonym für hohe Abbaugüte im Marmorsteinbruch.

« **Book match** » ou « **livre ouvert** » sont des termes utilisés pour décrire la possibilité de poser des dalles en continuité entre elles afin d’obtenir un effet de composition en miroir. Le résultat esthétique à peine décrit est particulièrement recherché dans le domaine des travailleurs de marbre, et est synonyme de très de haute qualité d’exploitation minière dans la carrière.

STATUARIO
ULTRA
BLOCK B

ULTRA®

ARIOSTEA GREAT SURFACES

MARMI

.....

RETTIFICATO MONOCALIBRO

RECTIFIED SINGLE-CALIBRE /
REKTIFIZIERT EINKALIBRIG /
RECTIFIÉ MONOCALIBRE

SPESSORE

THICKNESS / DICKE / ÉPAISSEUR

▼
6mm
▲

FORMATI

SIZES / FORMATE / FORMATS

300 x 150 cm

120" x 60"

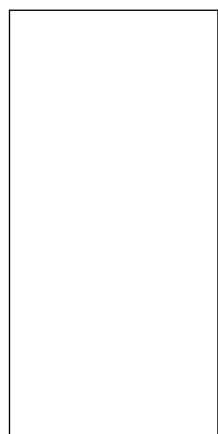

150 x 150 cm

60" x 60"



150 x 75 cm

60" x 30"



75 x 75 cm

30" x 30"

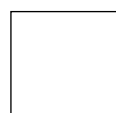

75 x 37,5 cm

30" x 15"



SUPERFICI / SURFACES / OBERFLÄCHEN / SURFACES

LUCIDATO SHINY

FORMATI pag. 414

SIZES pag. 414 / FORMATE pag. 414 / FORMATS pag. 414

300 X 150



PAONAZZETTO S



ULTRA[®]

ARIOSTEA GREAT SURFACES

MARMI

.....

RETTIFICATO MONOCALIBRO

RECTIFIED SINGLE-CALIBRE /
REKTIFIZIERT EINKALIBRIG /
RECTIFIÉ MONOCALIBRE

SPESSORE

THICKNESS / DICKE / ÉPAISSEUR

▼
6mm
▲

FORMATI

SIZES / FORMATE / FORMATS

300 x 150 cm

120" x 60"

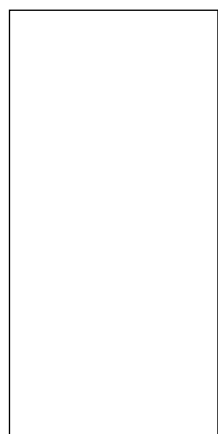

150 x 150 cm

60" x 60"



150 x 75 cm

60" x 30"

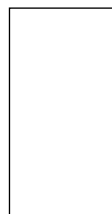

75 x 75 cm

30" x 30"

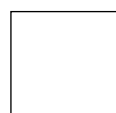

75 x 37,5 cm

30" x 15"



SUPERFICI / SURFACES / OBERFLÄCHEN / SURFACES

LUCIDATO SHINY

FORMATI pag. 414

SIZES pag. 414 / FORMATE pag. 414 / FORMATS pag. 414

300 X 150



TRAVERTINO NAVONA



ULTRA[®]

ARIOSTEA GREAT SURFACES

MARMI

.....

RETTIFICATO MONOCALIBRO

RECTIFIED SINGLE-CALIBRE /
REKTIFIZIERT EINKALIBRIG /
RECTIFIÉ MONOCALIBRE

SPESSORE

THICKNESS / DICKE / ÉPAISSEUR

▼
6mm
▲

FORMATI

SIZES / FORMATE / FORMATS

300 x 150 cm

120" x 60"



150 x 150 cm

60" x 60"

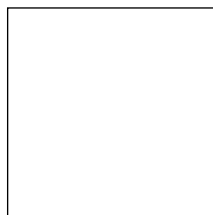

150 x 75 cm

60" x 30"



75 x 75 cm

30" x 30"

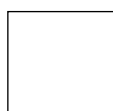

75 x 37,5 cm

30" x 15"



SUPERFICI / SURFACES / OBERFLÄCHEN / SURFACES

LUCIDATO SHINY

SOFT

FORMATI pag. 414

SIZES pag. 414 / FORMATE pag. 414 / FORMATS pag. 414

300 X 150



CREMA MARFIL



ULTRA®

ARIOSTEA GREAT SURFACES

MARMI

RETTIFICATO MONOCALIBRO

RECTIFIED SINGLE-CALIBRE /
REKTIFIZIERT EINKALIBRIG /
RECTIFIÉ MONOCALIBRE

SPESSORE

THICKNESS / DICKE / ÉPAISSEUR

▼
6mm
▲

FORMATI

SIZES / FORMATE / FORMATS

300 x 150 cm

120" x 60"

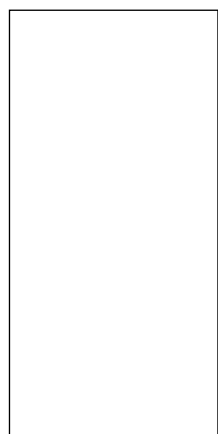

150 x 150 cm

60" x 60"

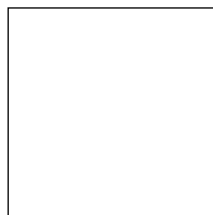

150 x 75 cm

60" x 30"

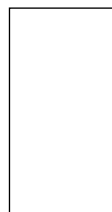

75 x 75 cm

30" x 30"

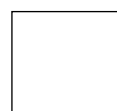

75 x 37,5 cm

30" x 15"



SUPERFICI / SURFACES / OBERFLÄCHEN / SURFACES

LUCIDATO SHINY

SOFT

FORMATI pag. 414

SIZES pag. 414 / FORMATE pag. 414 / FORMATS pag. 414

300X150

GRIS DE SAVOIE

ULTRA®

ARIOSTEA GREAT SURFACES

MARMI

RETTIFICATO MONOCALIBRO

RECTIFIED SINGLE-CALIBRE /
REKTIFIZIERT EINKALIBRIG /
RECTIFIÉ MONOCALIBRE

SPESSORE

THICKNESS / DICKE / ÉPAISSEUR

▼
6mm
▲

FORMATI

SIZES / FORMATE / FORMATS

300 x 150 cm

120" x 60"

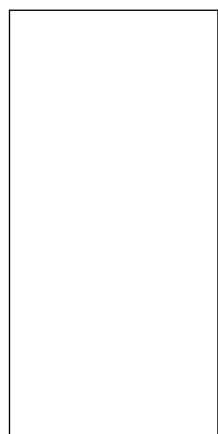

150 x 150 cm

60" x 60"

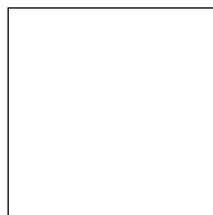

150 x 75 cm

60" x 30"



75 x 75 cm

30" x 30"

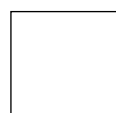

75 x 37,5 cm

30" x 15"



SUPERFICI / SURFACES / OBERFLÄCHEN / SURFACES

LUCIDATO SHINY

SOFT

FORMATI pag. 414

SIZES pag. 414 / FORMATE pag. 414 / FORMATS pag. 414

300X150



TRAVERTINO SANTA CATERINA



ULTRA[®]

ARIOSTEA GREAT SURFACES

MARMI

RETTIFICATO MONOCALIBRO

RECTIFIED SINGLE-CALIBRE /
REKTIFIZIERT EINKALIBRIG /
RECTIFIÉ MONOCALIBRE

SPESSORE

THICKNESS / DICKE / ÉPAISSEUR

▼
6mm
▲

FORMATI

SIZES / FORMATE / FORMATS

300 x 150 cm

120" x 60"

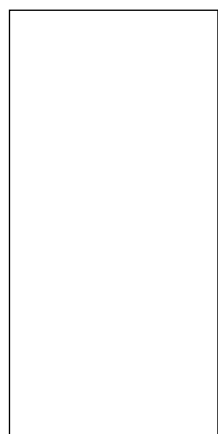

150 x 150 cm

60" x 60"



150 x 75 cm

60" x 30"

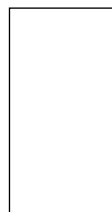

75 x 75 cm

30" x 30"



75 x 37,5 cm

30" x 15"



SUPERFICI / SURFACES / OBERFLÄCHEN / SURFACES

LUCIDATO SHINY

FORMATI pag. 414

SIZES pag. 414 / FORMATE pag. 414 / FORMATS pag. 414

300X150

ERAMOSA BROWN



ULTRA[®]

ARIOSTEA GREAT SURFACES

MARMI

.....

RETTIFICATO MONOCALIBRO

RECTIFIED SINGLE-CALIBRE /
REKTIFIZIERT EINKALIBRIG /
RECTIFIÉ MONOCALIBRE

SPESSORE

THICKNESS / DICKE / ÉPAISSEUR

▼
6mm
▲

FORMATI

SIZES / FORMATE / FORMATS

300 x 150 cm

120" x 60"

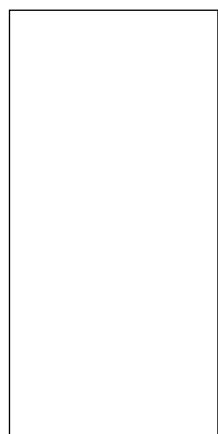

150 x 150 cm

60" x 60"

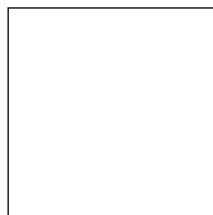

150 x 75 cm

60" x 30"



75 x 75 cm

30" x 30"

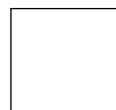

75 x 37,5 cm

30" x 15"



SUPERFICI / SURFACES / OBERFLÄCHEN / SURFACES

LUCIDATO SHINY

FORMATI pag. 414

SIZES pag. 414 / FORMATE pag. 414 / FORMATS pag. 414

300X150

ZEBRINO BLACK

ULTRA[®]

ARIOSTEA GREAT SURFACES

ONICI

RETTIFICATO MONOCALIBRO

RECTIFIED SINGLE-CALIBRE /
REKTIFIZIERT EINKALIBRIG /
RECTIFIÉ MONOCALIBRE

SPESSORE

THICKNESS / DICKE / ÉPAISSEUR

▼
6mm
▲

FORMATI

SIZES / FORMATE / FORMATS

300 x 150 cm

120" x 60"

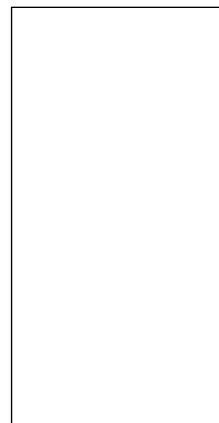

150 x 150 cm

60" x 60"



150 x 75 cm

60" x 30"

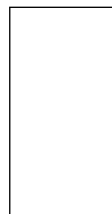

75 x 75 cm

30" x 30"



75 x 37,5 cm

30" x 15"



SUPERFICI / SURFACES / OBERFLÄCHEN / SURFACES

LUCIDATO SHINY

FORMATI pag. 415

SIZES pag. 415 / FORMATE pag. 415 / FORMATS pag. 415

300 X 150



ONICE PESCA



ULTRA[®]

ARIOSTEA GREAT SURFACES

ONICI

.....

RETTIFICATO MONOCALIBRO

RECTIFIED SINGLE-CALIBRE /
REKTIFIZIERT EINKALIBRIG /
RECTIFIÉ MONOCALIBRE

SPESSORE

THICKNESS / DICKE / ÉPAISSEUR

▼
6mm
▲

FORMATI

SIZES / FORMATE / FORMATS

300 x 150 cm

120" x 60"

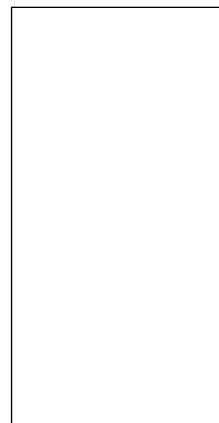

150 x 150 cm

60" x 60"

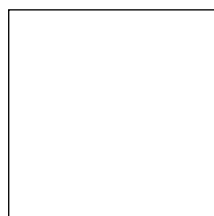

150 x 75 cm

60" x 30"

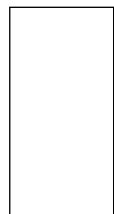

75 x 75 cm

30" x 30"



75 x 37,5 cm

30" x 15"



SUPERFICI / SURFACES / OBERFLÄCHEN / SURFACES

LUCIDATO SHINY

FORMATI pag. 415

SIZES pag. 415 / FORMATE pag. 415 / FORMATS pag. 415

300 X 150

ONICE PERSIA



ULTRA[®]

ARIOSTEA GREAT SURFACES

ONICI

.....

RETTIFICATO MONOCALIBRO

RECTIFIED SINGLE-CALIBRE /
REKTIFIZIERT EINKALIBRIG /
RECTIFIÉ MONOCALIBRE

SPESSORE

THICKNESS / DICKE / ÉPAISSEUR

▼
6mm
▲

FORMATI

SIZES / FORMATE / FORMATS

300 x 150 cm

120" x 60"

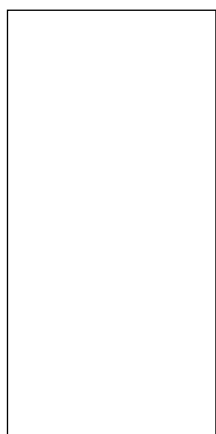

SUPERFICI / SURFACES /
OBERFLÄCHEN / SURFACES

LUCIDATO SHINY

FORMATI pag. 415

SIZES pag. 415 / FORMATE pag. 415 / FORMATS pag. 415

300 X 150

ONICE PERSIA BLOCK A



MACCHIA APERTA /
BOOK MATCH /
MUSTERSYMMETRIE /
LIVRE OUVERT

“**Book match**” o “**macchia aperta**” sono termini con cui si indica la possibilità di posare lastre in continuità tra di loro ottenendo un effetto speculare della composizione. Il risultato estetico descritto, è particolarmente ricercato nell’ambiente dei marmisti ed è sinonimo di altissima qualità estrattiva in cava.

“**Book match**” is a term used to describe the technique of laying panels side by side to produce an effect where the pattern is mirrored. The aesthetic result achieved is particularly esteemed by those who work in the marble industry, and is synonymous with high quality extraction from the quarry.

“**Book Match**” oder **Mustersymmetrie** sind Begriffe, die auf die Möglichkeit hindeuten, Platten fortlaufend nebeneinander zu verlegen und so einen Spiegeleffekt der Gesamtanordnung zu erhalten. Das beschriebene ästhetische Ergebnis ist bei Marmorverarbeitern sehr begehrt und ein Synonym für hohe Abbaugqualität im Marmorsteinbruch.

« **Book match** » ou « **livre ouvert** » sont des termes utilisés pour décrire la possibilité de poser des dalles en continuité entre elles afin d’obtenir un effet de composition en miroir. Le résultat esthétique à peine décrit est particulièrement recherché dans le domaine des travailleurs de marbre, et est synonyme de très de haute qualité d’exploitation minière dans la carrière.

ONICE PERSIA
BLOCK B

ULTRA[®]

ARIOSTEA GREAT SURFACES

ONICI

RETTIFICATO MONOCALIBRO

RECTIFIED SINGLE-CALIBRE /
REKTIFIZIERT EINKALIBRIG /
RECTIFIÉ MONOCALIBRE

SPESSORE

THICKNESS / DICKE / ÉPAISSEUR

▼
6mm
▲

FORMATI

SIZES / FORMATE / FORMATS

300 x 150 cm

120" x 60"

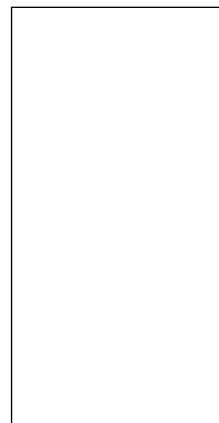

150 x 150 cm

60" x 60"

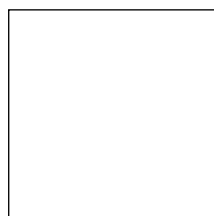

150 x 75 cm

60" x 30"

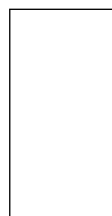

75 x 75 cm

30" x 30"

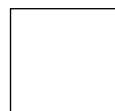

75 x 37,5 cm

30" x 15"



300 X 150

SUPERFICI / SURFACES / OBERFLÄCHEN / SURFACES

LUCIDATO SHINY

LEVIGATO SILK

FORMATI pag. 415

SIZES pag. 415 / FORMATE pag. 415 / FORMATS pag. 415

ONICE IVORY



ULTRA[®]

ARIOSTEA GREAT SURFACES

ONICI

RETTIFICATO MONOCALIBRO

RECTIFIED SINGLE-CALIBRE /
REKTIFIZIERT EINKALIBRIG /
RECTIFIÉ MONOCALIBRE

SPESSORE

THICKNESS / DICKE / ÉPAISSEUR

▼
6mm
▲

FORMATI

SIZES / FORMATE / FORMATS

300 x 150 cm

120" x 60"

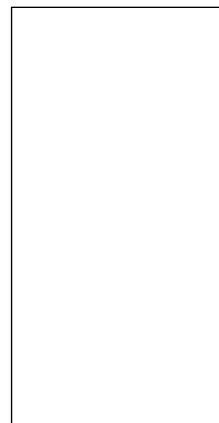

150 x 150 cm

60" x 60"

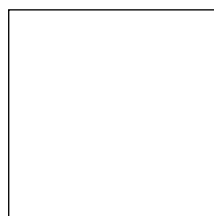

150 x 75 cm

60" x 30"

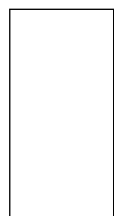

75 x 75 cm

30" x 30"

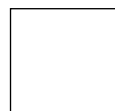

75 x 37,5 cm

30" x 15"



SUPERFICI / SURFACES / OBERFLÄCHEN / SURFACES

LUCIDATO SHINY

LEVIGATO SILK

FORMATI pag. 415

SIZES pag. 415 / FORMATE pag. 415 / FORMATS pag. 415

300 X 150



GREY ONYX VEIN CUT



ULTRA[®]

ARIOSTEA GREAT SURFACES

ONICI

RETTIFICATO MONOCALIBRO

RECTIFIED SINGLE-CALIBRE /
REKTIFIZIERT EINKALIBRIG /
RECTIFIÉ MONOCALIBRE

SPESSORE

THICKNESS / DICKE / ÉPAISSEUR

▼
6mm
▲

FORMATI

SIZES / FORMATE / FORMATS

300 x 150 cm

120" x 60"

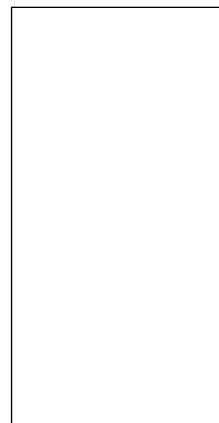

150 x 150 cm

60" x 60"

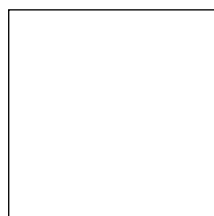

150 x 75 cm

60" x 30"

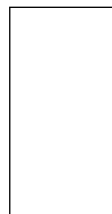

75 x 75 cm

30" x 30"



75 x 37,5 cm

30" x 15"



SUPERFICI / SURFACES / OBERFLÄCHEN / SURFACES

LUCIDATO SHINY

LEVIGATO SILK

FORMATI pag. 415

SIZES pag. 415 / FORMATE pag. 415 / FORMATS pag. 415

300 X 150

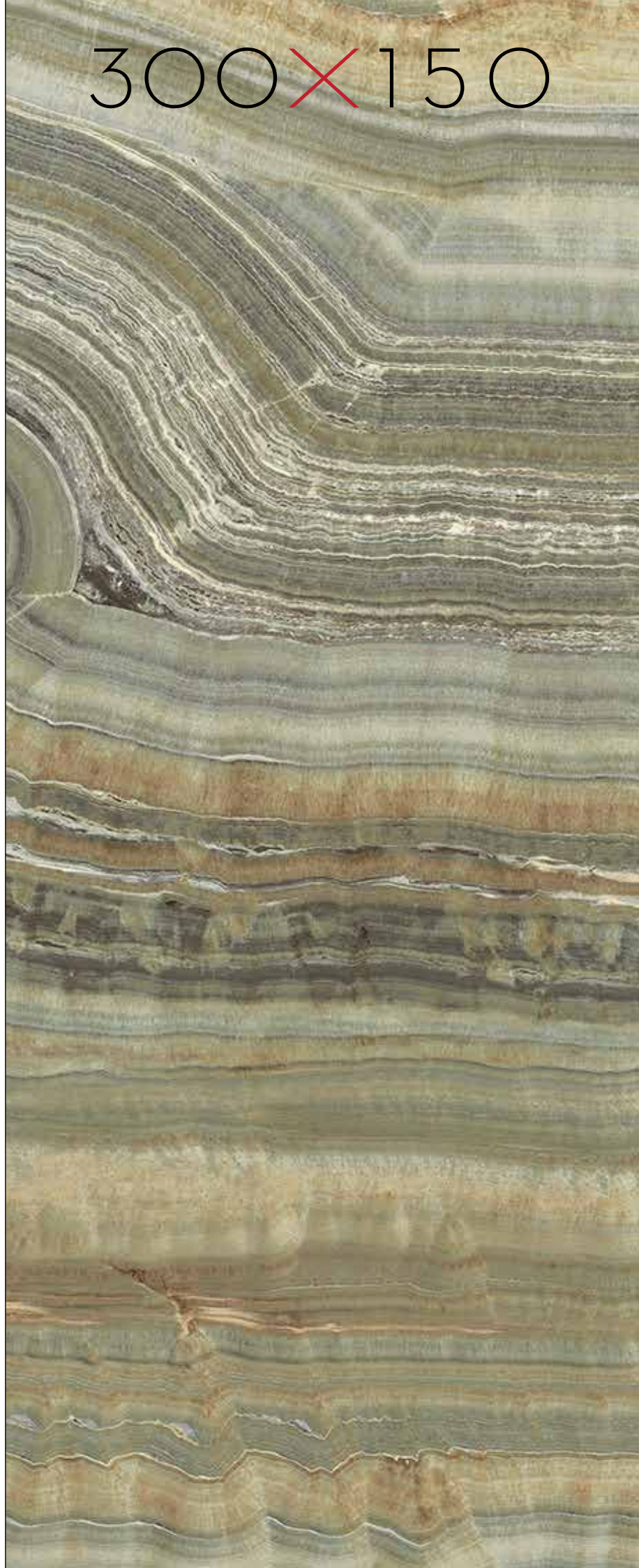

GREEN ONYX VEIN CUT



ULTRA®

ARIOSTEA GREAT SURFACES

ONICI

RETTIFICATO MONOCALIBRO

RECTIFIED SINGLE-CALIBRE /
REKTIFIZIERT EINKALIBRIG /
RECTIFIÉ MONOCALIBRE

SPESSORE

THICKNESS / DICKE / ÉPAISSEUR

▼
6mm
▲

FORMATI

SIZES / FORMATE / FORMATS

300 x 150 cm

120" x 60"

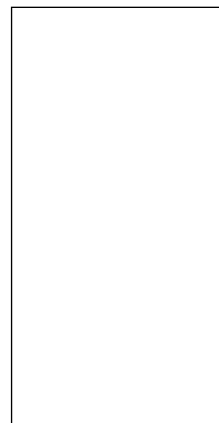

150 x 150 cm

60" x 60"

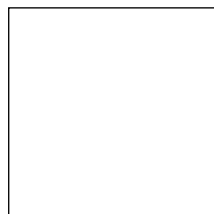

150 x 75 cm

60" x 30"

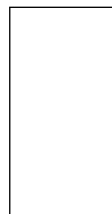

75 x 75 cm

30" x 30"



75 x 37,5 cm

30" x 15"



SUPERFICI / SURFACES / OBERFLÄCHEN / SURFACES

LUCIDATO SHINY

SOFT

FORMATI pag. 415

SIZES pag. 415 / FORMATE pag. 415 / FORMATS pag. 415

300 X 150

ONICE GRIGIO



ULTRA®

ARIOSTEA GREAT SURFACES

ONICI

RETTIFICATO MONOCALIBRO

RECTIFIED SINGLE-CALIBRE /
REKTIFIZIERT EINKALIBRIG /
RECTIFIÉ MONOCALIBRE

SPESSORE

THICKNESS / DICKE / ÉPAISSEUR

▼
6mm
▲

FORMATI

SIZES / FORMATE / FORMATS

300 x 150 cm

120" x 60"

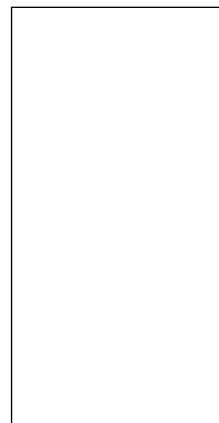

150 x 150 cm

60" x 60"



150 x 75 cm

60" x 30"

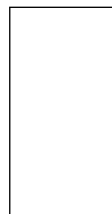

75 x 75 cm

30" x 30"



75 x 37,5 cm

30" x 15"



SUPERFICI / SURFACES / OBERFLÄCHEN / SURFACES

LUCIDATO SHINY

SOFT

FORMATI pag. 415

SIZES pag. 415 / FORMATE pag. 415 / FORMATS pag. 415

300 X 150

ONICE BIANCO EXTRA



ULTRA[®]

ARIOSTEA GREAT SURFACES

ONICI

.....

RETTIFICATO MONOCALIBRO

RECTIFIED SINGLE-CALIBRE /
REKTIFIZIERT EINKALIBRIG /
RECTIFIÉ MONOCALIBRE

SPESSORE

THICKNESS / DICKE / ÉPAISSEUR

▼
6mm
▲

FORMATI

SIZES / FORMATE / FORMATS

300 x 150 cm

120" x 60"



150 x 150 cm

60" x 60"



150 x 75 cm

60" x 30"



75 x 75 cm

30" x 30"

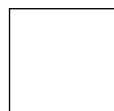

75 x 37,5 cm

30" x 15"



SUPERFICI / SURFACES / OBERFLÄCHEN / SURFACES

LUCIDATO SHINY

FORMATI pag. 415

SIZES pag. 415 / FORMATE pag. 415 / FORMATS pag. 415

300 X 150



ONICE BEIGE

ULTRA[®]

ARIOSTEA GREAT SURFACES

METAL

RETTIFICATO MONOCALIBRO

RECTIFIED SINGLE-CALIBRE /
REKTIFIZIERT EINKALIBRIG /
RECTIFIÉ MONOCALIBRE

SPESSORE

THICKNESS / DICKE / ÉPAISSEUR

▼
6mm
▲

FORMATI

SIZES / FORMATE / FORMATS

300 x 150 cm

120" x 60"

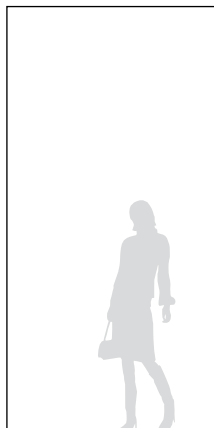

150 x 150 cm

60" x 60"

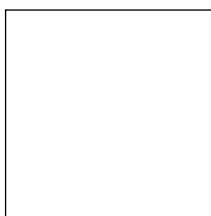

75 x 75 cm

30" x 30"



150 x 75 cm

60" x 30"



75 x 37,5 cm

30" x 15"



SUPERFICI / SURFACES / OBERFLÄCHEN / SURFACES

SOFT

FORMATI pag. 415

SIZES pag. 415 / FORMATE pag. 415 / FORMATS pag. 415

MALM
BLACK



MALM
GREY



SAPIENSTONE

dress your kitchen

NON RETTIFICATO /
UNRECTIFIED /
UNRECHTWINKELING /
NON RECTIFIÉ

FORMATI /
SIZES /
FORMATE /
FORMATS

328 x 154 cm

129" x 60"

SPESSORE /
THICKNESS /
DICKE /
ÉPAISSEUR

▼
12mm
▲

SUPERFICI /
SURFACES /
OBERFLÄCHEN /
SURFACES

NATURAL /
PRE-POLISHED

FORMATI pag. 416 / SIZES pag. 416 /
FORMATE pag. 416 / FORMATS pag. 416

300 X 150

BLACK PLATE

GREY PLATE

ULTRA[®]

ARIOSTEA GREAT SURFACES

METAL

.....

RETTIFICATO MONOCALIBRO

RECTIFIED SINGLE-CALIBRE /
REKTIFIZIERT EINKALIBRIG /
RECTIFIÉ MONOCALIBRE

SPESSORE

THICKNESS / DICKE / ÉPAISSEUR

▼
6mm
▲

FORMATI

SIZES / FORMATE / FORMATS

300 x 150 cm

120" x 60"

300 x 100 cm

120" x 40"

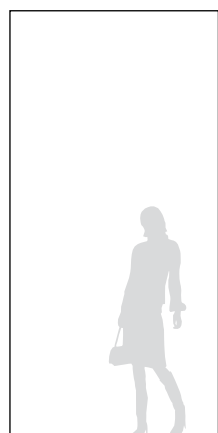

150 x 150 cm

60" x 60"

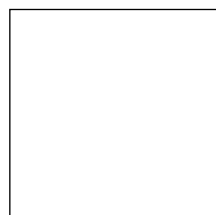

150 x 100 cm

60" x 40"

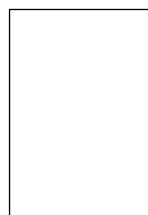

150 x 75 cm

60" x 30"

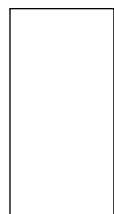

100 x 100 cm

40" x 40"

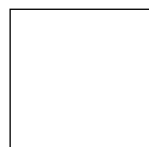

75 x 75 cm

30" x 30"



75 x 37,5 cm

30" x 15"



SUPERFICI / SURFACES / OBERFLÄCHEN / SURFACES

SOFT

FORMATI pag. 415

SIZES pag. 415 / FORMATE pag. 415 / FORMATS pag. 415

300 X 150

METRO

ULTRA TECHNOLOGY BY ARIOSTER HIGH-TECH

A close-up photograph of a textured surface with a blue-grey hue. The texture is uneven, with darker, more saturated blue-grey areas interspersed with lighter, almost white, patches, creating a mottled and organic appearance.

BLUE ZINC

A close-up photograph of a textured surface with a brownish-grey hue. The texture is mottled and uneven, with darker brown spots and lighter, greyish-brown areas, giving it a natural, aged appearance.

BROWN ZINC

A close-up photograph of a textured surface with a light grey hue. The texture is mottled and uneven, with darker grey spots and lighter, almost white, patches, creating a soft and natural appearance.

GREY ZINC

ULTRA[®]

ARIOSTEA GREAT SURFACES

CON.CREA.

.....

RETTIFICATO MONOCALIBRO

RECTIFIED SINGLE-CALIBRE /
REKTIFIZIERT EINKALIBRIG /
RECTIFIÉ MONOCALIBRE

SPESSORE

THICKNESS / DICKE / ÉPAISSEUR

▼
6mm
▲

FORMATI

SIZES / FORMATE / FORMATS

300 x 150 cm

120" x 60"

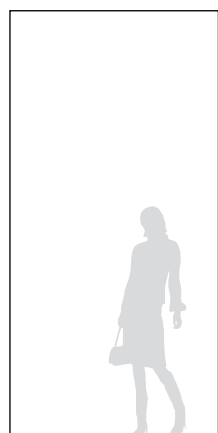

300 x 100 cm

120" x 40"



150 x 150 cm

60" x 60"



150 x 100 cm

60" x 40"

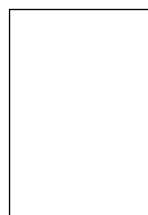

150 x 75 cm

60" x 30"

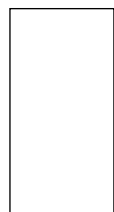

100 x 100 cm

40" x 40"

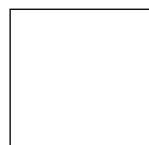

75 x 75 cm

30" x 30"



75 x 37,5 cm

30" x 15"



SUPERFICI / SURFACES / OBERFLÄCHEN / SURFACES

SOFT

FORMATI pag. 415

SIZES pag. 415 / FORMATE pag. 415 / FORMATS pag. 415

300 X 150

METRO

ULTRA TECHNOLOGY by ARIOSTEA HIGH-TECH

TALC

DOVE GREY

EARTH

ULTRA[®]

ARIOSTEA GREAT SURFACES

CON.CREA.

.....

RETTIFICATO MONOCALIBRO

RECTIFIED SINGLE-CALIBRE /
REKTIFIZIERT EINKALIBRIG /
RECTIFIÉ MONOCALIBRE

SPESSORE

THICKNESS / DICKE / ÉPAISSEUR

▼
6mm
▲

FORMATI

SIZES / FORMATE / FORMATS

300 x 150 cm

120" x 60"

300 x 100 cm

120" x 40"

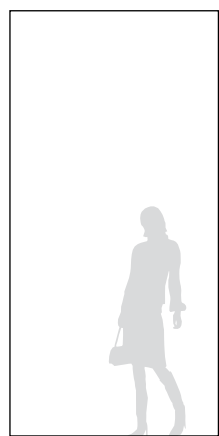

150 x 150 cm

60" x 60"

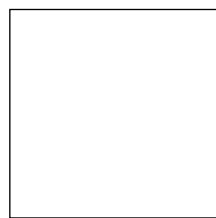

150 x 100 cm

60" x 40"

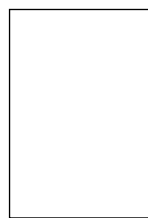

150 x 75 cm

60" x 30"

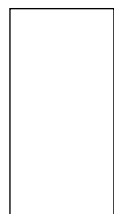

100 x 100 cm

40" x 40"

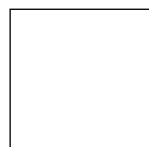

75 x 75 cm

30" x 30"



75 x 37,5 cm

30" x 15"



SUPERFICI / SURFACES / OBERFLÄCHEN / SURFACES

SOFT

FORMATI pag. 415

SIZES pag. 415 / FORMATE pag. 415 / FORMATS pag. 415

300 X 150

METRO

ULTRA TECHNOLOGY by ARIOSTEA HIGH-TECH

CLOUD

INK

ULTRA®

ARIOSTEA GREAT SURFACES

TEKNOSTONE

.....

RETTIFICATO MONOCALIBRO
RECTIFIED SINGLE-CALIBRE /
REKTIFIZIERT EINKALIBRIG /
RECTIFIÉ MONOCALIBRE

SPESSORE
THICKNESS / DICKE / ÉPAISSEUR

▼
6mm
▲

FORMATI

SIZES / FORMATE / FORMATS

300 x 100 cm
120" x 40"

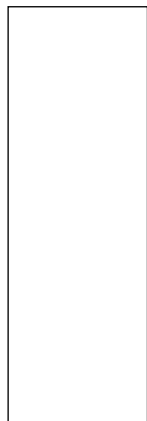

100 x 100 cm
40" x 40"

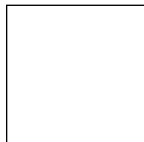

SUPERFICI / SURFACES / OBERFLÄCHEN / SURFACES

SOFT

FORMATI pag. 415

SIZES pag. 415 / FORMATE pag. 415 / FORMATS pag. 415

SAND
EARTH



BROWN
EARTH



SAPIENSTONE
dress your kitchen

NON RETTIFICATO /
UNRECTIFIED /
UNRECHTWINKELING /
NON RECTIFIÉ

FORMATI / **328 x 154 cm** /
SIZES / **129" x 60"**
FORMATE /
FORMATS

SPESSORE /
THICKNESS /
DICKE /
ÉPAISSEUR

▼
12mm
▲

SUPERFICI / **NATURAL**
SURFACES /
OBERFLÄCHEN /
SURFACES

FORMATI pag. 416 / SIZES pag. 416 /
FORMATE pag. 416 / FORMATS pag. 416

METRO
ULTRA TECHNOLOGY by ARIOSTEA HIGH-TECH

TAUPE

TOBACCO

ULTRA®

ARIOSTEA GREAT SURFACES

TEKNOSTONE

.....

RETTIFICATO MONOCALIBRO
RECTIFIED SINGLE-CALIBRE /
REKTIFIZIERT EINKALIBRIG /
RECTIFIÉ MONOCALIBRE

SPESSORE
THICKNESS / DICKE / ÉPAISSEUR

▼
6mm
▲

FORMATI
SIZES / FORMATE / FORMATS

300 x 100 cm
120" x 40"



100 x 100 cm
40" x 40"

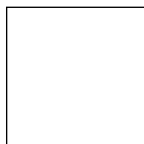

SUPERFICI / SURFACES / OBERFLÄCHEN / SURFACES

SOFT

FORMATI pag. 415

SIZES pag. 415 / FORMATE pag. 415 / FORMATS pag. 415

LIGHT
EARTH



GREY
EARTH



SAPIENSTONE

dress your kitchen

NON RETTIFICATO /
UNRECTIFIED /
UNRECHTWINKELING /
NON RECTIFIÉ

FORMATI / **328 x 154 cm** /
SIZES /
FORMATE / 129" x 60"
FORMATS

SPESSORE /
THICKNESS /
DICKE /
ÉPAISSEUR

▼
12mm
▲

SUPERFICI / **NATURAL**
SURFACES /
OBERFLÄCHEN /
SURFACES

FORMATI pag. 416 / SIZES pag. 416 /
FORMATE pag. 416 / FORMATS pag. 416

METRO

ULTRA TECHNOLOGY by ARIOSTEA HIGH-TECH

LIGHT GREY

SMOKE

ULTRA®

ARIOSTEA GREAT SURFACES

P i e t r e

RETTIFICATO MONOCALIBRO
RECTIFIED SINGLE-CALIBRE /
REKTIFIZIERT EINKALIBRIG /
RECTIFIÉ MONOCALIBRE

SPESSORE
THICKNESS / DICKE / ÉPAISSEUR

▼
6mm
▲

FORMATI

SIZES / FORMATE / FORMATS

300 x 100 cm
120" x 40"

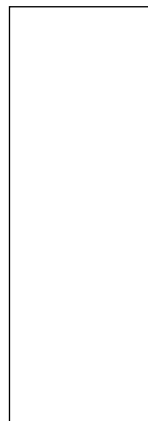

150 x 100 cm
60" x 40"

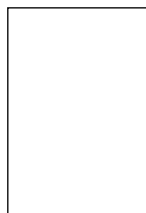

100 x 100 cm
40" x 40"

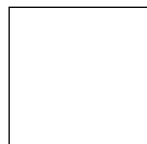

SUPERFICI / SURFACES / OBERFLÄCHEN / SURFACES

SOFT

FORMATI pag. 414

SIZES pag. 414 / FORMATE pag. 414 / FORMATS pag. 414

BASALT BLACK

SAPIENSTONE

dress your kitchen

NON RETTIFICATO / UNRECTIFIED /
UNRECHTWINKELING / NON RECTIFIÉ

FORMATI /
SIZES /
FORMATE /
FORMATS

328 x 154 cm
129" x 60"

SPESSORE /
THICKNESS /
DICKE /
ÉPAISSEUR

▼
12mm
▲

SUPERFICI /
SURFACES /
OBERFLÄCHEN /
SURFACES

NATURAL

FORMATI pag. 416 / SIZES pag. 416 / FORMATE pag. 416 / FORMATS pag. 416

METRO

ULTRA TECHNOLOGY by ARIOSTEA HIGH-TECH

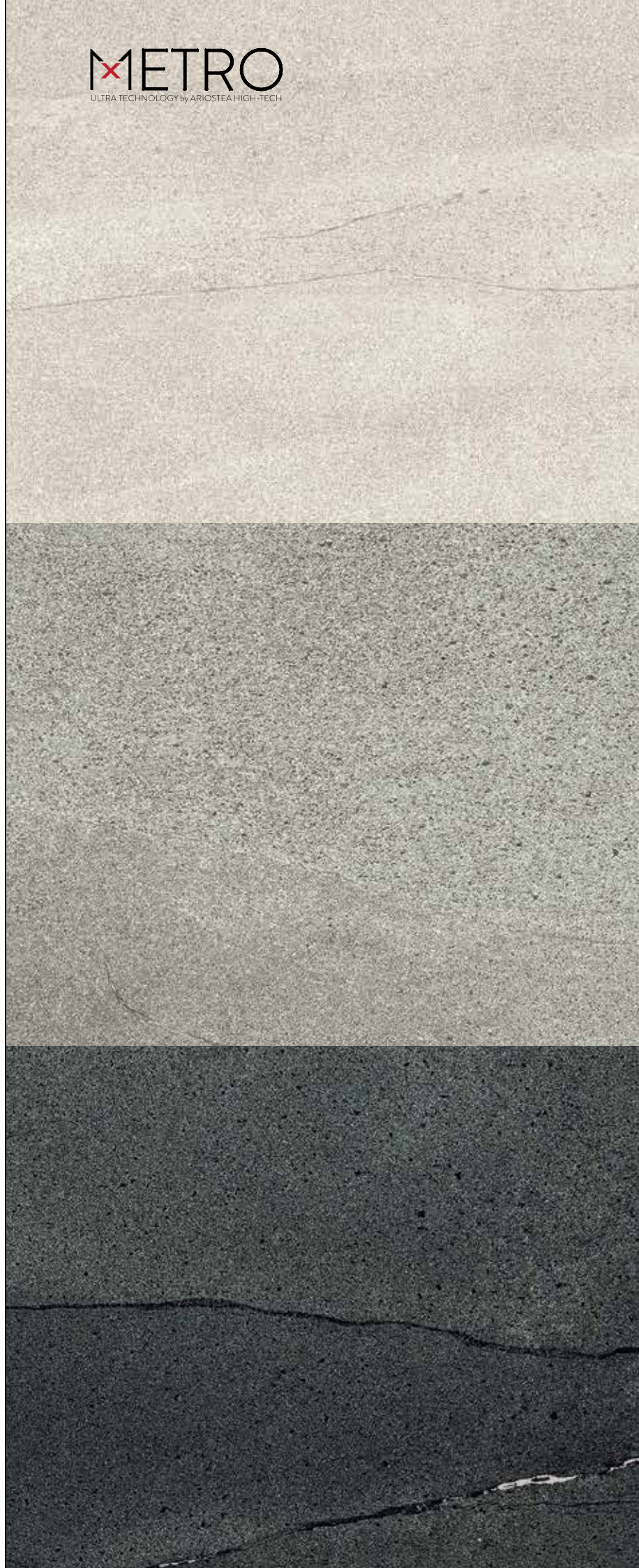

A close-up photograph of a light-colored, textured surface, likely a wall or ceiling, showing a fine, granular texture and several horizontal, slightly irregular cracks or creases. The color is a pale, off-white or light beige.

BASALTINA WHITE

A close-up photograph of a medium-grey textured surface, similar to the one above but with a darker hue. It features a fine, granular texture and a few horizontal cracks or creases.

BASALTINA GREY

A close-up photograph of a dark, almost black textured surface. The texture is very fine and granular, with some subtle variations in tone and a few small, faint marks or imperfections.

BASALTINA ANTRACITE

ULTRA[®]

ARIOSTEA GREAT SURFACES

P i e t r e

RETTIFICATO MONOCALIBRO

RECTIFIED SINGLE-CALIBRE /
REKTIFIZIERT EINKALIBRIG /
RECTIFIÉ MONOCALIBRE

SPESSORE

THICKNESS / DICKE / ÉPAISSEUR

▼
6mm
▲

FORMATI

SIZES / FORMATE / FORMATS

300 x 100 cm

120" x 40"

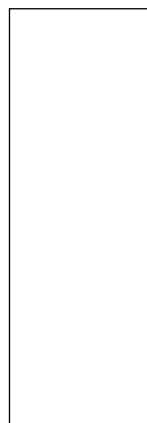

150 x 100 cm

60" x 40"



100 x 100 cm

40" x 40"

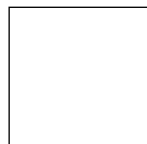

SUPERFICI / SURFACES / OBERFLÄCHEN / SURFACES

SOFT

FORMATI pag. 414

SIZES pag. 414 / FORMATE pag. 414 / FORMATS pag. 414

BASALT CREAM

SAPIENSTONE

dress your kitchen

NON RETTIFICATO / UNRECTIFIED /
UNRECHTWINKELING / NON RECTIFIÉ

FORMATI /
SIZES /
FORMATE /
FORMATS

328 x 154 cm
129" x 60"

SPESSORE /
THICKNESS /
DICKE /
ÉPAISSEUR

▼
12mm
▲

SUPERFICI /
SURFACES /
OBERFLÄCHEN /
SURFACES

NATURAL

FORMATI pag. 416 / SIZES pag. 416 / FORMATE pag. 416 / FORMATS pag. 416

METRO

ULTRA TECHNOLOGY by ARIOSTEA HIGH-TECH



BASALTINA SAND



BASALTINA MOKA

ULTRA[®]

ARIOSTEA GREAT SURFACES

P i e t r e

.....

RETTIFICATO MONOCALIBRO

RECTIFIED SINGLE-CALIBRE /
REKTIFIZIERT EINKALIBRIG /
RECTIFIÉ MONOCALIBRE

SPESSORE

THICKNESS / DICKE / ÉPAISSEUR

▼
6mm
▲

FORMATI

SIZES / FORMATE / FORMATS

300 x 100 cm

120" x 40"

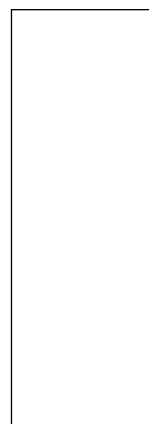

150 x 100 cm

60" x 40"

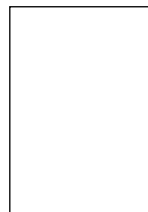

100 x 100 cm

40" x 40"

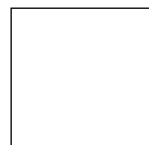

SUPERFICI / SURFACES / OBERFLÄCHEN / SURFACES

STRUCTURED

FORMATI pag. 414

SIZES pag. 414 / FORMATE pag. 414 / FORMATS pag. 414

METRO

ULTRA TECHNOLOGY by ARIOSTEA HIGH-TECH



JERUSALEM LIMESTONE



AZUL BATEIG LIMESTONE



SAN VICENTE LIMESTONE

ULTRA[®]

ARIOSTEA GREAT SURFACES

Resine

RETTIFICATO MONOCALIBRO
RECTIFIED SINGLE-CALIBRE /
REKTIFIZIERT EINKALIBRIG /
RECTIFIÉ MONOCALIBRE

SPESSORE
THICKNESS / DICKE / ÉPAISSEUR

▼
6mm
▲

FORMATI

SIZES / FORMATE / FORMATS

300 x 100 cm
120" x 40"

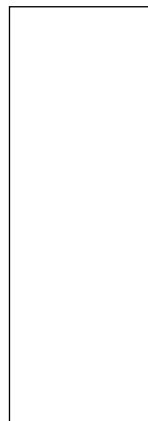

150 x 100 cm
60" x 40"



100 x 100 cm
40" x 40"

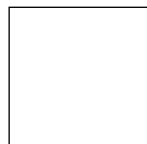

SUPERFICI / SURFACES / OBERFLÄCHEN / SURFACES

SOFT

FORMATI pag. 415

SIZES pag. 415 / FORMATE pag. 415 / FORMATS pag. 415

URBAN ARGENTO

SAPIENSTONE

dress your kitchen

NON RETTIFICATO / UNRECTIFIED /
UNRECHTWINKELING / NON RECTIFIÉ

FORMATI /
SIZES /
FORMATE /
FORMATS

328 x 154 cm
129" x 60"

SPESSORE /
THICKNESS /
DICKE /
ÉPAISSEUR

▼
12mm
▲

SUPERFICI /
SURFACES /
OBERFLÄCHEN /
SURFACES

NATURAL

FORMATI pag. 416 / SIZES pag. 416 / FORMATE pag. 416 / FORMATS pag. 416

METRO
ULTRA TECHNOLOGY by ARIOSTEA HIGH-TECH

SILICIO

PIOMBO

ULTRA[®]

ARIOSTEA GREAT SURFACES

Resine

RETTIFICATO MONOCALIBRO
RECTIFIED SINGLE-CALIBRE /
REKTIFIZIERT EINKALIBRIG /
RECTIFIÉ MONOCALIBRE

SPESSORE
THICKNESS / DICKE / ÉPAISSEUR

▼
6mm
▲

FORMATI

SIZES / FORMATE / FORMATS

300 x 100 cm
120" x 40"

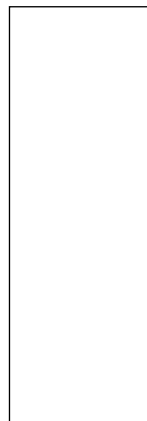

150 x 100 cm
60" x 40"

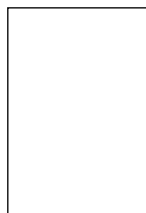

100 x 100 cm
40" x 40"

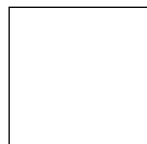

SUPERFICI / SURFACES / OBERFLÄCHEN / SURFACES

SOFT

FORMATI pag. 415

SIZES pag. 415 / FORMATE pag. 415 / FORMATS pag. 415

URBAN ANTRACITE

SAPIENSTONE

dress your kitchen

NON RETTIFICATO / UNRECTIFIED /
UNRECHTWINKELING / NON RECTIFIÉ

FORMATI /
SIZES /
FORMATE /
FORMATS

328 x 154 cm
129" x 60"

SPESSORE /
THICKNESS /
DICKE /
ÉPAISSEUR

▼
12mm
▲

SUPERFICI /
SURFACES /
OBERFLÄCHEN /
SURFACES

NATURAL

FORMATI pag. 416 / SIZES pag. 416 / FORMATE pag. 416 / FORMATS pag. 416

METRO
ULTRA TECHNOLOGY by ARIOSTEA HIGH-TECH

CALCE

EBANO

ULTRA[®]

ARIOSTEA GREAT SURFACES

iCementi

.....

RETTIFICATO MONOCALIBRO

RECTIFIED SINGLE-CALIBRE /
REKTIFIZIERT EINKALIBRIG /
RECTIFIÉ MONOCALIBRE

SPESSORE

THICKNESS / DICKE / ÉPAISSEUR

▼
6mm
▲

FORMATI

SIZES / FORMATE / FORMATS

300 x 150 cm
120" x 60"

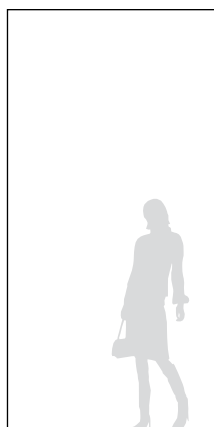

300 x 100 cm
120" x 40"



150 x 150 cm
60" x 60"



150 x 100 cm
60" x 40"

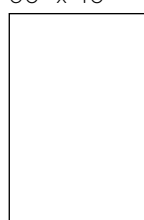

150 x 75 cm
60" x 30"

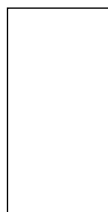

100 x 100 cm
40" x 40"

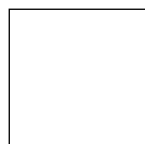

75 x 75 cm
30" x 30"

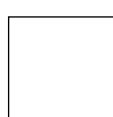

75 x 37,5 cm
30" x 15"



SUPERFICI / SURFACES / OBERFLÄCHEN / SURFACES

SOFT

FORMATI pag. 414

SIZES pag. 414 / FORMATE pag. 414 / FORMATS pag. 414

300 X 150

METRO

ULTRA TECHNOLOGY by ARIOSTEA HIGH-TECH

SILVER

IRON

GRAPHITE

ULTRA[®]

ARIOSTEA GREAT SURFACES

iCementi

.....

RETTIFICATO MONOCALIBRO

RECTIFIED SINGLE-CALIBRE /
REKTIFIZIERT EINKALIBRIG /
RECTIFIÉ MONOCALIBRE

SPESSORE

THICKNESS / DICKE / ÉPAISSEUR

▼
6mm
▲

FORMATI

SIZES / FORMATE / FORMATS

300 x 150 cm

120" x 60"

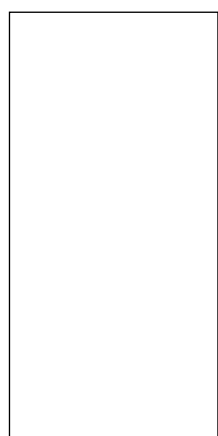

150 x 150 cm

60" x 60"



150 x 75 cm

60" x 30"



75 x 75 cm

30" x 30"

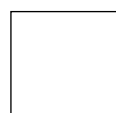

75 x 37,5 cm

30" x 15"



SUPERFICI / SURFACES / OBERFLÄCHEN / SURFACES

SOFT

FORMATI pag. 414

SIZES pag. 414 / FORMATE pag. 414 / FORMATS pag. 414

300 X 150

IVORY

BRONZE

ULTRA[®]

ARIOSTEA GREAT SURFACES

BLEND.HT

.....

RETTIFICATO MONOCALIBRO

RECTIFIED SINGLE-CALIBRE /
REKTIFIZIERT EINKALIBRIG /
RECTIFIÉ MONOCALIBRE

SPESSORE

THICKNESS / DICKE / ÉPAISSEUR

▼
6mm
▲

FORMATI

SIZES / FORMATE / FORMATS

100 x 100 cm

40" x 40"

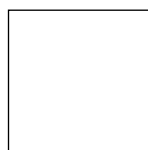

SUPERFICI / SURFACES / OBERFLÄCHEN / SURFACES

LEVIGATO SILK

SOFT

FORMATI pag. 415

SIZES pag. 415 / FORMATE pag. 415 / FORMATS pag. 415

METRO

ULTRA TECHNOLOGY by ARIOSTEA HIGH-TECH



BL01

BL05

ULTRA[®]

ARIOSTEA GREAT SURFACES

BLEND.HT

.....

RETTIFICATO MONOCALIBRO

RECTIFIED SINGLE-CALIBRE /
REKTIFIZIERT EINKALIBRIG /
RECTIFIÉ MONOCALIBRE

SPESSORE

THICKNESS / DICKE / ÉPAISSEUR

▼
6mm
▲

FORMATI

SIZES / FORMATE / FORMATS

100 x 100 cm

40" x 40"

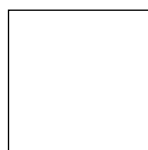

SUPERFICI / SURFACES / OBERFLÄCHEN / SURFACES

LEVIGATO SILK
SOFT

FORMATI pag. 415

SIZES pag. 415 / FORMATE pag. 415 / FORMATS pag. 415

METRO
ULTRA TECHNOLOGY by ARIOSTEA HIGH-TECH



BL02

BL03

BL04

ULTRA[®]

ARIOSTEA GREAT SURFACES

IRIDIUM

RETTIFICATO MONOCALIBRO

RECTIFIED SINGLE-CALIBRE /
REKTIFIZIERT EINKALIBRIG /
RECTIFIÉ MONOCALIBRE

SPESSORE

THICKNESS / DICKE / ÉPAISSEUR

▼
6mm
▲

FORMATI

SIZES / FORMATE / FORMATS

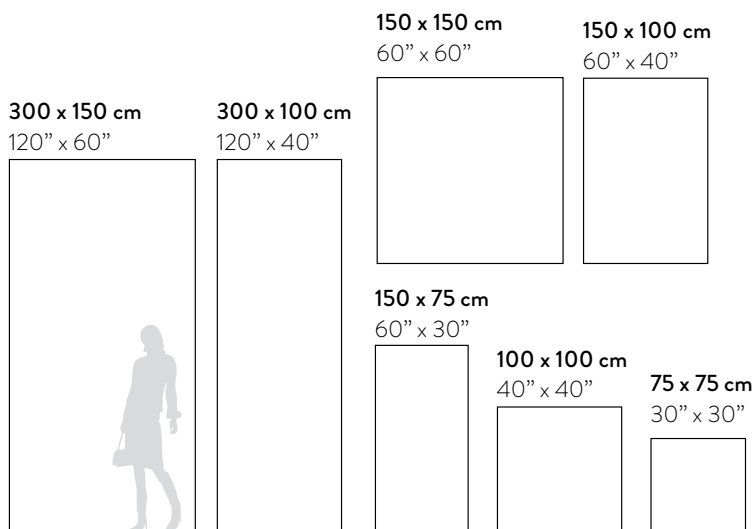

SUPERFICI / SURFACES / OBERFLÄCHEN / SURFACES

LUCIDATO SHINY

SOFT

FORMATI pag. 415

SIZES pag. 415 / FORMATE pag. 415 / FORMATS pag. 415



UNI ICE

SAPIENSTONE

dress your kitchen

NON RETTIFICATO / UNRECTIFIED /
UNRECHTWINKELING / NON RECTIFIÉ

FORMATI /
SIZES /
FORMATE /
FORMATS

328 x 154 cm
129" x 60"

SPESSORE /
THICKNESS /
DICKE /
ÉPAISSEUR

▼ ▼
12mm 20mm
▲ ▲

SUPERFICI /
SURFACES /
OBERFLÄCHEN /
SURFACES

**NATURAL /
POLISHED**

FORMATI pag. 416 / SIZES pag. 416 / FORMATE pag. 416 / FORMATS pag. 416

300 X 150

METRO

ULTRA TECHNOLOGY by ARIOSTEA HIGH-TECH

NERO

BIANCO



**FINITURE / FINISH /
OBERFLÄCHENAUSFÜHRUNG / FINITION**



LEVIGATO SILK

LEVIGATO E LUCIDATO /
HONED AND POLISHED / GESCHLIFFEN UND POLIERT /
POLI ET LUSTRÉ LUCIDATO

LUCIDATO

SOFT
R9 / R10

BAMBOO
R12 - A+B+C

NATURALE /
NATURAL / NATURBELASSEN / NATUREL
R9 - A / R9 - A+B / R10 / R10 - A+B

SEMILUCIDATO /
SEMI-POLISHED / SEMI-MATT / SEMI-LUSTRÉ
R10 - A

STRUTTURATO /
STRUCTURED / STRUKTURIERT / STRUCTURÉ
R10 A+B / R11 - A / R11 - A+B / R11 - A+B+C

ANTICATO /
ANTIQUED / ANTIK / ANTIQUE
R9 - A / R10 - A / R10 - A+B /
R10 - A+B+C / R11 - A / R11 - A+B / R11 - A+B+C
INNOVATIVE SLABS LEGNI HIGH-TECH / LEGNI HIGH-TECH

SATINATO /
SATIN-FINISH / SATINIERT / SATINÉ
R9 / R10 / R10 - A+B / R10 - A+B+C





BIANCO CARRARA	166
NERO MARQUINIA	168
ONICE IVORY	170
GREY ONYX VEIN CUT	172
BIANCO CALACATTA	174
STATUARIO ALTISSIMO	176
GRIS DE SAVOIE	178
GREY MARBLE	180

MARMI cento2cento



BIANCO CARRARA

MARMI cento2cento

RETTIFICATO MONOCALIBRO

RECTIFIED SINGLE-CALIBRE / REKTIFIZIERT EINKALIBRIG /
RECTIFIÉ MONOCALIBRE

SPESSORE

THICKNESS / DICKE / ÉPAISSEUR

▼
9 mm
▲

FORMATI

SIZES / FORMATE / FORMATS

200 x 100 cm

80"x 40"



100 x 100 cm

40"x 40"



SUPERFICI / SURFACES / OBERFLÄCHEN / SURFACES

LEVIGATO SILK

LUCIDATO

COEFFICIENTE DI ATTRITO

FRICITION COEFFICIENT
REIBUNGSKOEFFIZIENT
COEFFICIENT DE FROTTEMENT

-

FORMATI / SIZES / FORMATE / FORMATS

pag. 417

RETTIFICATO MONOCALIBRO

RECTIFIED SINGLE-CALIBRE / REKTIFIZIERT EINKALIBRIG /
RECTIFIÉ MONOCALIBRE

SPESSORE

THICKNESS / DICKE / ÉPAISSEUR

▼
9 mm
▲

FORMATI

SIZES / FORMATE / FORMATS

200 x 100 cm

80"x 40"

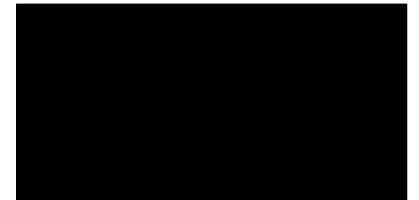

100 x 100 cm

40"x 40"



SUPERFICI / SURFACES / OBERFLÄCHEN / SURFACES

LEVIGATO SILK

LUCIDATO

COEFFICIENTE DI ATTRITO

FRICION COEFFICIENT

REIBUNGSKOEFFIZIENT

COEFFICIENT DE FROTTEMENT

-

FORMATI / SIZES / FORMATE / FORMATS

pag. 417



ONICE IVORY

MARMI cento2cento

RETTIFICATO MONOCALIBRO

RECTIFIED SINGLE-CALIBRE / REKTIFIZIERT EINKALIBRIG /
RECTIFIÉ MONOCALIBRE

SPESSORE

THICKNESS / DICKE / ÉPAISSEUR

▼
9 mm
▲

FORMATI

SIZES / FORMATE / FORMATS

200 x 100 cm

80"x 40"



100 x 100 cm

40"x 40"



SUPERFICI / SURFACES / OBERFLÄCHEN / SURFACES

LEVIGATO SILK

LUCIDATO

COEFFICIENTE DI ATTRITO

FRICITION COEFFICIENT
REIBUNGSKOEFFIZIENT
COEFFICIENT DE FROTTEMENT

-

FORMATI / SIZES / FORMATE / FORMATS

pag. 417



GREY ONYX VEIN CUT

MARMI cento2cento

RETTIFICATO MONOCALIBRO

RECTIFIED SINGLE-CALIBRE / REKTIFIZIERT EINKALIBRIG /
RECTIFIÉ MONOCALIBRE

SPESSORE

THICKNESS / DICKE / ÉPAISSEUR

▼
9 mm
▲

FORMATI

SIZES / FORMATE / FORMATS

200 x 100 cm

80"x 40"



100 x 100 cm

40"x 40"

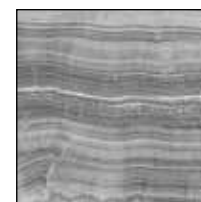

SUPERFICI / SURFACES / OBERFLÄCHEN / SURFACES

LEVIGATO SILK

LUCIDATO

COEFFICIENTE DI ATTRITO

FRICITION COEFFICIENT

REIBUNGSKOEFFIZIENT

COEFFICIENT DE FROTTEMENT

-

FORMATI / SIZES / FORMATE / FORMATS

pag. 417

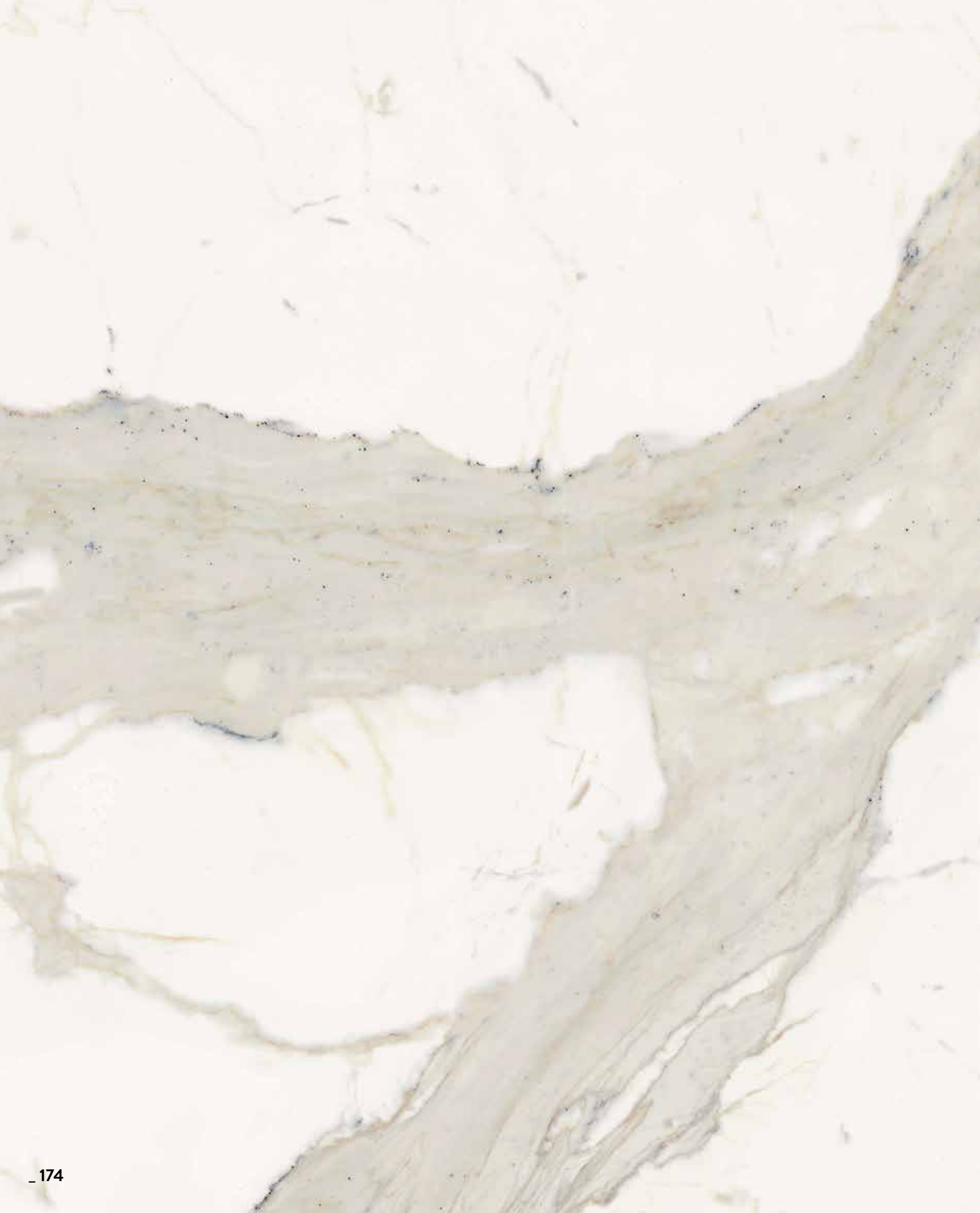

BIANCO CALACATTA

MARMI cento2cento

RETTIFICATO MONOCALIBRO

RECTIFIED SINGLE-CALIBRE / REKTIFIZIERT EINKALIBRIG /
RECTIFIÉ MONOCALIBRE

SPESSORE

THICKNESS / DICKE / ÉPAISSEUR

▼
9 mm
▲

FORMATI

SIZES / FORMATE / FORMATS

200 x 100 cm

80"x 40"



100 x 100 cm

40"x 40"



SUPERFICI / SURFACES / OBERFLÄCHEN / SURFACES

LUCIDATO

SOFT

COEFFICIENTE DI ATTRITO

FRICION COEFFICIENT

REIBUNGSKOEFFIZIENT

COEFFICIENT DE FROTTEMENT

SO **(R9)**

FORMATI / SIZES / FORMATE / FORMATS

pag. 417

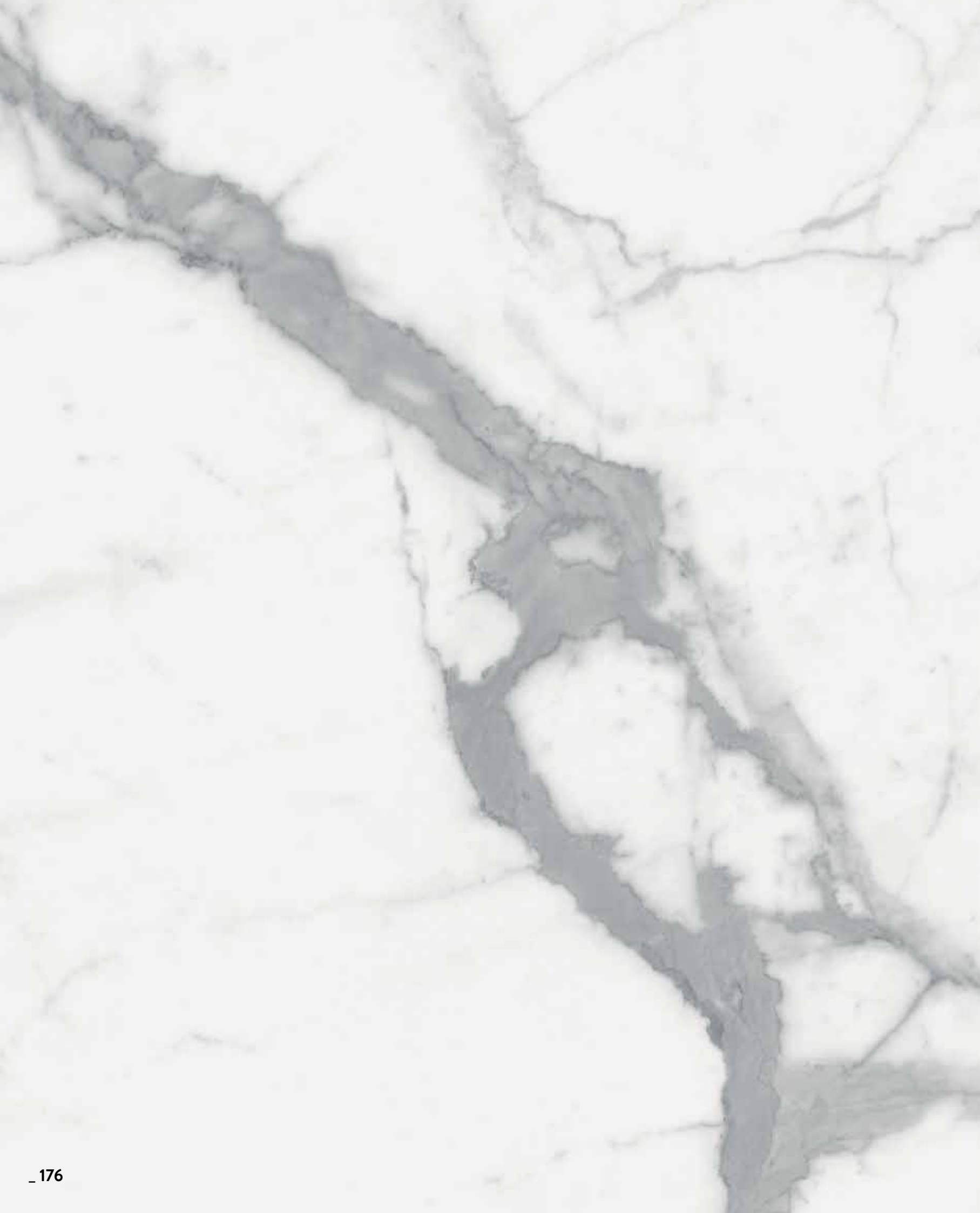

STATUARIO ALTISSIMO

MARMI cento2cento

RETTIFICATO MONOCALIBRO

RECTIFIED SINGLE-CALIBRE / REKTIFIZIERT EINKALIBRIG /
RECTIFIÉ MONOCALIBRE

SPESSORE

THICKNESS / DICKE / ÉPAISSEUR

▼
9 mm
▲

FORMATI

SIZES / FORMATE / FORMATS

200 x 100 cm

80" x 40"

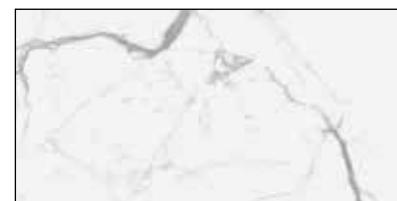

100 x 100 cm

40" x 40"

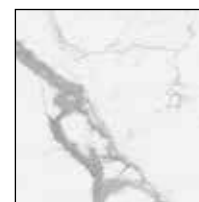

SUPERFICI / SURFACES / OBERFLÄCHEN / SURFACES

LUCIDATO

SOFT

COEFFICIENTE DI ATTRITO

FRICION COEFFICIENT
REIBUNGSKOEFFIZIENT
COEFFICIENT DE FROTTEMENT

SO (R9)

FORMATI / SIZES / FORMATE / FORMATS

pag. 417

GRIS DE SAVOIE

MARMI cento2cento

RETTIFICATO MONOCALIBRO

RECTIFIED SINGLE-CALIBRE / REKTIFIZIERT EINKALIBRIG /
RECTIFIÉ MONOCALIBRE

SPESSORE

THICKNESS / DICKE / ÉPAISSEUR

▼
9 mm
▲

FORMATI

SIZES / FORMATE / FORMATS

200 x 100 cm

80"x 40"



100 x 100 cm

40"x 40"



SUPERFICI / SURFACES / OBERFLÄCHEN / SURFACES

LUCIDATO

SOFT

COEFFICIENTE DI ATTRITO

FRICITION COEFFICIENT

REIBUNGSKOEFFIZIENT

COEFFICIENT DE FROTTEMENT

SO (R9)

FORMATI / SIZES / FORMATE / FORMATS

pag. 417



GREY MARBLE

MARMI cento2cento

RETTIFICATO MONOCALIBRO

RECTIFIED SINGLE-CALIBRE / REKTIFIZIERT EINKALIBRIG /
RECTIFIÉ MONOCALIBRE

SPESSORE

THICKNESS / DICKE / ÉPAISSEUR

▼
9 mm
▲

FORMATI

SIZES / FORMATE / FORMATS

200 x 100 cm

80"x 40"



100 x 100 cm

40"x 40"



SUPERFICI / SURFACES / OBERFLÄCHEN / SURFACES

LUCIDATO

SOFT

COEFFICIENTE DI ATTRITO

FRICITION COEFFICIENT
REIBUNGSKOEFFIZIENT
COEFFICIENT DE FROTTEMENT

SO (R9)

FORMATI / SIZES / FORMATE / FORMATS

pag. 417

ONICE BIANCO EXTRA	184
BIANCO CARRARA	186
BIANCO CALACATTA	188
BIANCO COVELANO	190
CALACATTA LINCOLN	192
THASSOS	194
CREMA MARFIL	196
GRIS DE SAVOIE	198
NERO MARQUINIA	200
GREY MARBLE	202
ONICE PERLATO	204
STATUARIO CLASSICO	206
ZEBRINO BIANCO	208
ARABESCATO CLASSICO	210
PULPIS GREY	212

MARMI CLASSICI

ONICE BIANCO EXTRA

MARMI CLASSICI

RETTIFICATO MONOCALIBRO

RECTIFIED SINGLE-CALIBRE / REKTIFIZIERT EINKALIBRIG /
RECTIFIÉ MONOCALIBRE

SPESSORE

THICKNESS / DICKE / ÉPAISSEUR

$\frac{\nabla}{8 \text{ mm}}$
 \triangle

FORMATI

SIZES / FORMATE / FORMATS

120 x 60 cm

48" x 24"

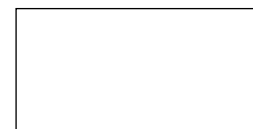

60 x 60 cm

24" x 24"

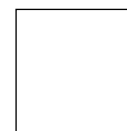

60 x 30 cm

24" x 12"



SUPERFICI / SURFACES / OBERFLÄCHEN / SURFACES

LEVIGATO SILK

LUCIDATO

COEFFICIENTE DI ATTRITO

FRICION COEFFICIENT
REIBUNGSKOEFFIZIENT
COEFFICIENT DE FROTTEMENT

-

FORMATI / SIZES / FORMATE / FORMATS

pag. 417

PEZZI SPECIALI / TRIMS / FORMTEILE / PIÈCES SPÉCIALES

pag. 417



BIANCO CARRARA

MARMI CLASSICI

RETTIFICATO MONOCALIBRO

RECTIFIED SINGLE-CALIBRE / REKTIFIZIERT EINKALIBRIG /
RECTIFIÉ MONOCALIBRE

SPESSORE

THICKNESS / DICKE / ÉPAISSEUR

$\frac{\text{8 mm}}{\text{▲}}$

FORMATI

SIZES / FORMATE / FORMATS

120 x 60 cm

48" x 24"

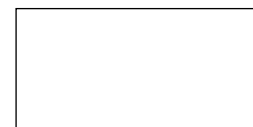

60 x 60 cm

24" x 24"

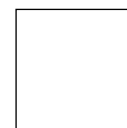

60 x 30 cm

24" x 12"



SUPERFICI / SURFACES / OBERFLÄCHEN / SURFACES

LEVIGATO SILK

LUCIDATO

COEFFICIENTE DI ATTRITO

FRICTION COEFFICIENT
REIBUNGSKOEFFIZIENT
COEFFICIENT DE FROTTEMENT

-

FORMATI / SIZES / FORMATE / FORMATS

pag. 417

PEZZI SPECIALI / TRIMS / FORMTEILE / PIÈCES SPÉCIALES

pag. 417

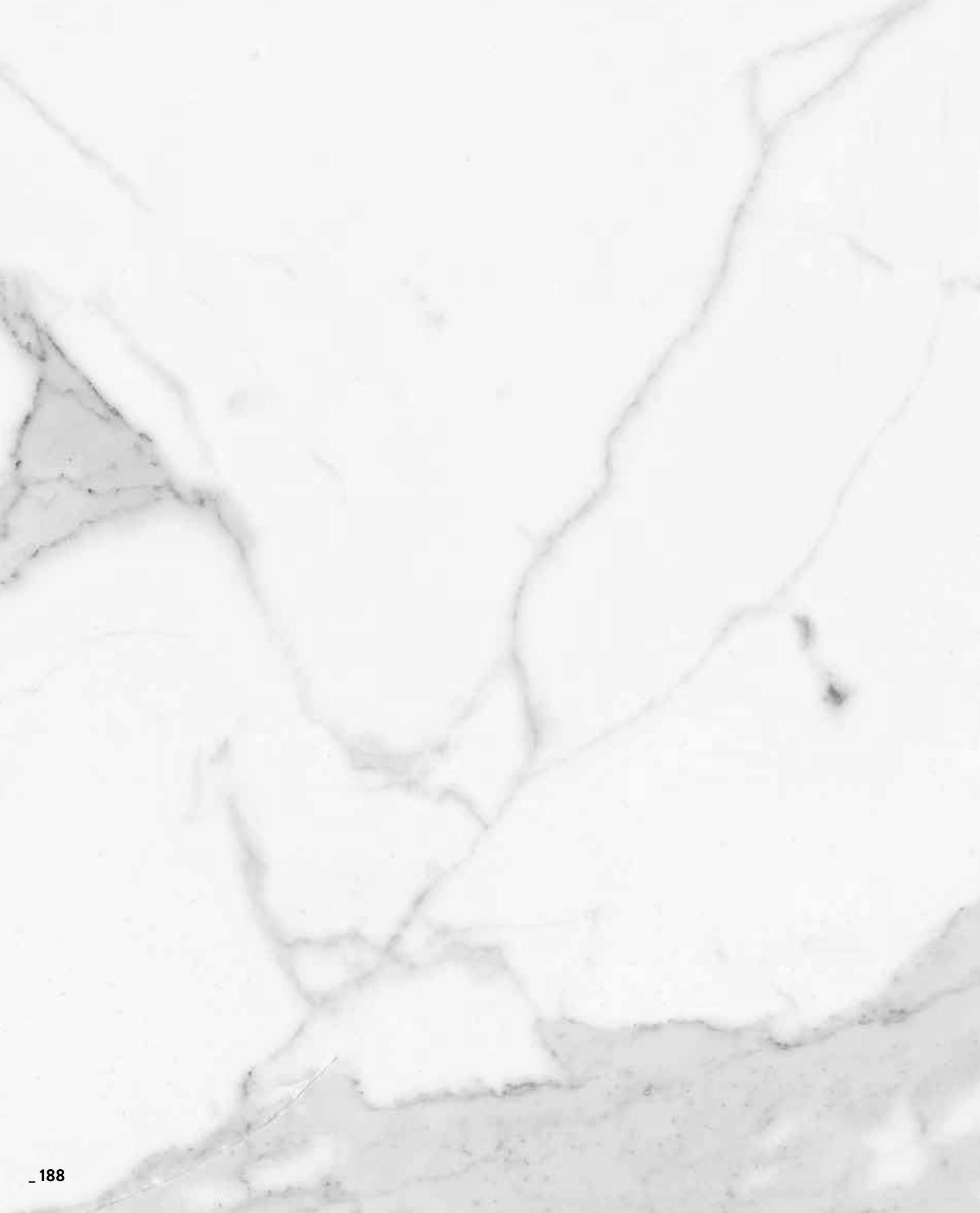

BIANCO CALACATTA

MARMI CLASSICI

RETTIFICATO MONOCALIBRO

RECTIFIED SINGLE-CALIBRE / REKTIFIZIERT EINKALIBRIG /
RECTIFIÉ MONOCALIBRE

SPESSORE

THICKNESS / DICKE / ÉPAISSEUR

8 mm

FORMATI

SIZES / FORMATE / FORMATS

120 x 60 cm

48" x 24"



60 x 60 cm

24" x 24"



60 x 30 cm

24" x 12"



SUPERFICI / SURFACES / OBERFLÄCHEN / SURFACES

LUCIDATO

SOFT

COEFFICIENTE DI ATTRITO

FRICITION COEFFICIENT
REIBUNGSKOEFFIZIENT
COEFFICIENT DE FROTTEMENT

SO (R9)

FORMATI / SIZES / FORMATE / FORMATS

pag. 417

PEZZI SPECIALI / TRIMS / FORMTEILE / PIÈCES SPÉCIALES

pag. 417

BIANCO COVELANO

MARMI CLASSICI

RETTIFICATO MONOCALIBRO

RECTIFIED SINGLE-CALIBRE / REKTIFIZIERT EINKALIBRIG /
RECTIFIÉ MONOCALIBRE

SPESSORE

THICKNESS / DICKE / ÉPAISSEUR

▼
8 mm
▲

FORMATI

SIZES / FORMATE / FORMATS

120 x 60 cm

48" x 24"



60 x 60 cm

24" x 24"



60 x 30 cm

24" x 12"



SUPERFICI / SURFACES / OBERFLÄCHEN / SURFACES

LUCIDATO

SOFT

COEFFICIENTE DI ATTRITO

FRICITION COEFFICIENT
REIBUNGSKOEFFIZIENT
COEFFICIENT DE FROTTEMENT

SO (R9)

FORMATI / SIZES / FORMATE / FORMATS

pag. 417

PEZZI SPECIALI / TRIMS / FORMTEILE / PIÈCES SPÉCIALES

pag. 417



CALACATTA LINCOLN

MARMI CLASSICI

RETTIFICATO MONOCALIBRO

RECTIFIED SINGLE-CALIBRE / REKTIFIZIERT EINKALIBRIG /
RECTIFIÉ MONOCALIBRE

SPESSORE

THICKNESS / DICKE / ÉPAISSEUR

8 mm

FORMATI

SIZES / FORMATE / FORMATS

120 x 60 cm

48" x 24"



60 x 60 cm

24" x 24"



60 x 30 cm

24" x 12"

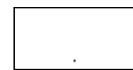

SUPERFICI / SURFACES / OBERFLÄCHEN / SURFACES

LUCIDATO

SOFT

COEFFICIENTE DI ATTRITO

FRICITION COEFFICIENT
REIBUNGSKOEFFIZIENT
COEFFICIENT DE FROTTEMENT

SO (R9)

FORMATI / SIZES / FORMATE / FORMATS

pag. 417

PEZZI SPECIALI / TRIMS / FORMTEILE / PIÈCES SPÉCIALES

pag. 417

THASSOS

MARMI CLASSICI

RETTIFICATO MONOCALIBRO

RECTIFIED SINGLE-CALIBRE / REKTIFIZIERT EINKALIBRIG /
RECTIFIÉ MONOCALIBRE

SPESSORE

THICKNESS / DICKE / ÉPAISSEUR

8 mm

FORMATI

SIZES / FORMATE / FORMATS

120 x 60 cm
48" x 24"



60 x 60 cm
24" x 24"

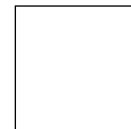

60 x 30 cm
24" x 12"



SUPERFICI / SURFACES / OBERFLÄCHEN / SURFACES

LUCIDATO

SOFT

COEFFICIENTE DI ATTRITO

FRICION COEFFICIENT
REIBUNGSKOEFFIZIENT
COEFFICIENT DE FROTTEMENT

SO (R9)

FORMATI / SIZES / FORMATE / FORMATS

pag. 417

PEZZI SPECIALI / TRIMS / FORMTEILE / PIÈCES SPÉCIALES

pag. 417



CREMA MARFIL

MARMI CLASSICI

RETTIFICATO MONOCALIBRO

RECTIFIED SINGLE-CALIBRE / REKTIFIZIERT EINKALIBRIG /
RECTIFIÉ MONOCALIBRE

SPESSORE

THICKNESS / DICKE / ÉPAISSEUR

8 mm

FORMATI

SIZES / FORMATE / FORMATS

120 x 60 cm
48" x 24"

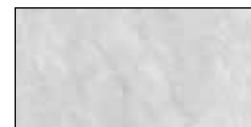

60 x 60 cm
24" x 24"



60 x 30 cm
24" x 12"

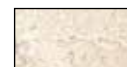

SUPERFICI / SURFACES / OBERFLÄCHEN / SURFACES

LUCIDATO

SOFT

COEFFICIENTE DI ATTRITO

FRICITION COEFFICIENT
REIBUNGSKOEFFIZIENT
COEFFICIENT DE FROTTEMENT

SO (R9)

FORMATI / SIZES / FORMATE / FORMATS

pag. 417

PEZZI SPECIALI / TRIMS / FORMTEILE / PIÈCES SPÉCIALES

pag. 417



GRIS DE SAVOIE

MARMI CLASSICI

RETTIFICATO MONOCALIBRO

RECTIFIED SINGLE-CALIBRE / REKTIFIZIERT EINKALIBRIG /
RECTIFIÉ MONOCALIBRE

SPESSORE

THICKNESS / DICKE / ÉPAISSEUR

$\frac{\text{8 mm}}{\text{▲}}$

FORMATI

SIZES / FORMATE / FORMATS

120 x 60 cm

48" x 24"



60 x 60 cm

24" x 24"



60 x 30 cm

24" x 12"



SUPERFICI / SURFACES / OBERFLÄCHEN / SURFACES

LUCIDATO

SOFT

COEFFICIENTE DI ATTRITO

FRICITION COEFFICIENT
REIBUNGSKOEFFIZIENT
COEFFICIENT DE FROTTEMENT

SO $\text{\textcircled{R9}}$

FORMATI / SIZES / FORMATE / FORMATS

pag. 417

PEZZI SPECIALI / TRIMS / FORMTEILE / PIÈCES SPÉCIALES

pag. 417

RETTIFICATO MONOCALIBRO

RECTIFIED SINGLE-CALIBRE / REKTIFIZIERT EINKALIBRIG /
RECTIFIÉ MONOCALIBRE

SPESSORE

THICKNESS / DICKE / ÉPAISSEUR

8 mm

FORMATI

SIZES / FORMATE / FORMATS

120 x 60 cm

48" x 24"

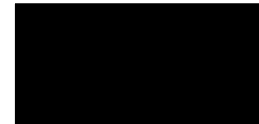

60 x 60 cm

24" x 24"



60 x 30 cm

24" x 12"



SUPERFICI / SURFACES / OBERFLÄCHEN / SURFACES

LEVIGATO SILK

LUCIDATO

COEFFICIENTE DI ATTRITO

FRICTION COEFFICIENT
REIBUNGSKOEFFIZIENT
COEFFICIENT DE FROTTEMENT

-

FORMATI / SIZES / FORMATE / FORMATS

pag. 417

PEZZI SPECIALI / TRIMS / FORMTEILE / PIÈCES SPÉCIALES

pag. 417

GREY MARBLE

MARMI CLASSICI

RETTIFICATO MONOCALIBRO

RECTIFIED SINGLE-CALIBRE / REKTIFIZIERT EINKALIBRIG /
RECTIFIÉ MONOCALIBRE

SPESSORE

THICKNESS / DICKE / ÉPAISSEUR

8 mm

FORMATI

SIZES / FORMATE / FORMATS

120 x 60 cm

48" x 24"



60 x 60 cm

24" x 24"



60 x 30 cm

24" x 12"



SUPERFICI / SURFACES / OBERFLÄCHEN / SURFACES

LUCIDATO

SOFT

COEFFICIENTE DI ATTRITO

FRICITION COEFFICIENT
REIBUNGSKOEFFIZIENT
COEFFICIENT DE FROTTEMENT

SO (R9)

FORMATI / SIZES / FORMATE / FORMATS

pag. 417

PEZZI SPECIALI / TRIMS / FORMTEILE / PIÈCES SPÉCIALES

pag. 417



ONICE PERLATO

MARMI CLASSICI

RETTIFICATO MONOCALIBRO

RECTIFIED SINGLE-CALIBRE / REKTIFIZIERT EINKALIBRIG /
RECTIFIÉ MONOCALIBRE

SPESSORE

THICKNESS / DICKE / ÉPAISSEUR

8 mm

FORMATI

SIZES / FORMATE / FORMATS

120 x 60 cm

48" x 24"



60 x 60 cm

24" x 24"



60 x 30 cm

24" x 12"



SUPERFICI / SURFACES / OBERFLÄCHEN / SURFACES

LUCIDATO

SOFT

COEFFICIENTE DI ATTRITO

FRICTION COEFFICIENT
REIBUNGSKOEFFIZIENT
COEFFICIENT DE FROTTEMENT

SO **R9**

FORMATI / SIZES / FORMATE / FORMATS

pag. 417

PEZZI SPECIALI / TRIMS / FORMTEILE / PIÈCES SPÉCIALES

pag. 417



STATUARIO CLASSICO

MARMI CLASSICI

RETTIFICATO MONOCALIBRO

RECTIFIED SINGLE-CALIBRE / REKTIFIZIERT EINKALIBRIG /
RECTIFIÉ MONOCALIBRE

SPESSORE

THICKNESS / DICKE / ÉPAISSEUR

8 mm

FORMATI

SIZES / FORMATE / FORMATS

120 x 60 cm

48" x 24"



60 x 60 cm

24" x 24"



60 x 30 cm

24" x 12"

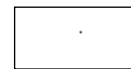

SUPERFICI / SURFACES / OBERFLÄCHEN / SURFACES

LUCIDATO

SOFT

COEFFICIENTE DI ATTRITO

FRICTION COEFFICIENT
REIBUNGSKOEFFIZIENT
COEFFICIENT DE FROTTEMENT

SO **R9**

FORMATI / SIZES / FORMATE / FORMATS

pag. 417

PEZZI SPECIALI / TRIMS / FORMTEILE / PIÈCES SPÉCIALES

pag. 417

ZEBRINO BIANCO

MARMI CLASSICI

RETTIFICATO MONOCALIBRO

RECTIFIED SINGLE-CALIBRE / REKTIFIZIERT EINKALIBRIG /
RECTIFIÉ MONOCALIBRE

SPESSORE

THICKNESS / DICKE / ÉPAISSEUR

8 mm

FORMATI

SIZES / FORMATE / FORMATS

120 x 60 cm

48" x 24"

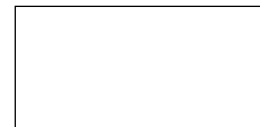

60 x 60 cm

24" x 24"

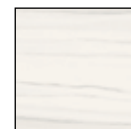

60 x 30 cm

24" x 12"

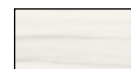

SUPERFICI / SURFACES / OBERFLÄCHEN / SURFACES

LUCIDATO

SOFT

COEFFICIENTE DI ATTRITO

FRICTION COEFFICIENT
REIBUNGSKOEFFIZIENT
COEFFICIENT DE FROTTEMENT

SO (R9)

FORMATI / SIZES / FORMATE / FORMATS

pag. 417

PEZZI SPECIALI / TRIMS / FORMTEILE / PIÈCES SPÉCIALES

pag. 417



ARABESCATO CLASSICO

MARMI CLASSICI

RETTIFICATO MONOCALIBRO

RECTIFIED SINGLE-CALIBRE / REKTIFIZIERT EINKALIBRIG /
RECTIFIÉ MONOCALIBRE

SPESSORE

THICKNESS / DICKE / ÉPAISSEUR

8 mm

FORMATI

SIZES / FORMATE / FORMATS

120 x 60 cm

48" x 24"



60 x 60 cm

24" x 24"



60 x 30 cm

24" x 12"



SUPERFICI / SURFACES / OBERFLÄCHEN / SURFACES

LUCIDATO

SOFT

COEFFICIENTE DI ATTRITO

FRICTION COEFFICIENT

REIBUNGSKOEFFIZIENT

COEFFICIENT DE FROTTEMENT

SO **R9**

FORMATI / SIZES / FORMATE / FORMATS

pag. 417

PEZZI SPECIALI / TRIMS / FORMTEILE / PIÈCES SPÉCIALES

pag. 417

PULPIS GREY

MARMI CLASSICI

RETTIFICATO MONOCALIBRO

RECTIFIED SINGLE-CALIBRE / REKTIFIZIERT EINKALIBRIG /
RECTIFIÉ MONOCALIBRE

SPESSORE

THICKNESS / DICKE / ÉPAISSEUR

$\frac{\nabla}{8 \text{ mm}}$
 \triangle

FORMATI

SIZES / FORMATE / FORMATS

120 x 60 cm

48" x 24"



60 x 60 cm

24" x 24"



60 x 30 cm

24" x 12"



SUPERFICI / SURFACES / OBERFLÄCHEN / SURFACES

LUCIDATO

SOFT

COEFFICIENTE DI ATTRITO

FRICITION COEFFICIENT

REIBUNGSKOEFFIZIENT

COEFFICIENT DE FROTTEMENT

SO **(R9)**

FORMATI / SIZES / FORMATE / FORMATS

pag. 417

PEZZI SPECIALI / TRIMS / FORMTEILE / PIÈCES SPÉCIALES

pag. 417

GOLBORNE LIMESTONE	216
ALDWYCH LIMESTONE	218
STRANMERE LIMESTONE	220
BLACK ARDESIA	222

PIETRE cento2cento

GOLBORNE LIMESTONE

PIETRE cento2cento

RETTIFICATO MONOCALIBRO

RECTIFIED SINGLE-CALIBRE / REKTIFIZIERT EINKALIBRIG /
RECTIFIÉ MONOCALIBRE

SPESSORE

THICKNESS / DICKE / ÉPAISSEUR

$\frac{\nabla}{6 \text{ mm}}$ $\frac{\nabla}{9 \text{ mm}}$
 \triangle \triangle

FORMATI

SIZES / FORMATE / FORMATS

200 x 100 cm

80" x 40"



100 x 100 cm

40" x 40"



SUPERFICI / SURFACES / OBERFLÄCHEN / SURFACES

SOFT

COEFFICIENTE DI ATTRITO

FRICITION COEFFICIENT
REIBUNGSKOEFFIZIENT
COEFFICIENT DE FROTTEMENT

so (R10)

FORMATI / SIZES / FORMATE / FORMATS

pag. 417



ALDWYCH LIMESTONE

PIETRE cento2cento

RETTIFICATO MONOCALIBRO

RECTIFIED SINGLE-CALIBRE / REKTIFIZIERT EINKALIBRIG /
RECTIFIÉ MONOCALIBRE

SPESSORE

THICKNESS / DICKE / ÉPAISSEUR

$\frac{\nabla}{6 \text{ mm}}$ $\frac{\nabla}{9 \text{ mm}}$
 $\frac{\nabla}{\blacktriangle}$ $\frac{\nabla}{\blacktriangle}$

FORMATI

SIZES / FORMATE / FORMATS

200 x 100 cm

80" x 40"



100 x 100 cm

40" x 40"



SUPERFICI / SURFACES / OBERFLÄCHEN / SURFACES

SOFT

COEFFICIENTE DI ATTRITO

FRICITION COEFFICIENT
REIBUNGSKOEFFIZIENT
COEFFICIENT DE FROTTEMENT

so (R10)

FORMATI / SIZES / FORMATE / FORMATS

pag. 417

STRANMERE LIMESTONE

PIETRE cento2cento

RETTIFICATO MONOCALIBRO

RECTIFIED SINGLE-CALIBRE / REKTIFIZIERT EINKALIBRIG /
RECTIFIÉ MONOCALIBRE

SPESSORE

THICKNESS / DICKE / ÉPAISSEUR

$\frac{\nabla}{6 \text{ mm}}$ $\frac{\nabla}{9 \text{ mm}}$
 \triangle \triangle

FORMATI

SIZES / FORMATE / FORMATS

200 x 100 cm

80"x 40"



100 x 100 cm

40"x 40"



SUPERFICI / SURFACES / OBERFLÄCHEN / SURFACES

SOFT

COEFFICIENTE DI ATTRITO

FRICITION COEFFICIENT
REIBUNGSKOEFFIZIENT
COEFFICIENT DE FROTTEMENT

so (R10)

FORMATI / SIZES / FORMATE / FORMATS

pag. 417

RETTIFICATO MONOCALIBRO

RECTIFIED SINGLE-CALIBRE / REKTIFIZIERT EINKALIBRIG /
RECTIFIÉ MONOCALIBRE

SPESSORE

THICKNESS / DICKE / ÉPAISSEUR

▼
6 mm
▲

FORMATI

SIZES / FORMATE / FORMATS

100 x 100 cm

40" x 40"



SUPERFICI / SURFACES / OBERFLÄCHEN / SURFACES

STRUTTURATO / STRUCTURED / STRUKTURIERT / STRUCTURÉ

COEFFICIENTE DI ATTRITO

FRICION COEFFICIENT

REIBUNGSKOEFFIZIENT

COEFFICIENT DE FROTTEMENT

ST (R10)

FORMATI / SIZES / FORMATE / FORMATS

pag. 417

CLOUD 226

EARTH 228

INK 230

TALC 232

DOVE GREY 234

CON.CREA.

CLOUD

CON.CREA.

RETTIFICATO MONOCALIBRO
RECTIFIED SINGLE-CALIBRE / REKTIFIZIERT EINKALIBRIG /
RECTIFIÉ MONOCALIBRE

FORMATI
SIZES / FORMATE / FORMATS

SPESSORE
THICKNESS / DICKE / ÉPAISSEUR

ULTRA 6 mm
ABSORBA GREAT SURFACES

SPESSORE
THICKNESS / DICKE / ÉPAISSEUR

9 mm

120 x 60 cm
48" x 24"



60 x 60 cm
24" x 24"

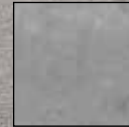

60 x 30 cm
24" x 12"



SPESSORE
THICKNESS / DICKE / ÉPAISSEUR

2 cm

120 x 60 cm
48" x 24"



60 x 60 cm
24" x 24"



SUPERFICI
SURFACES
OBERFLÄCHEN
SURFACES

NATURALE / NATURAL / NATURBELASSEN / NATUREL

ANTISCIVOLO / ANTISLIP

PRELUCIDATO

COEFFICIENTE DI ATTRITO
FRICTION COEFFICIENT
REIBUNGSKOEFFIZIENT
COEFFICIENT DE FROTTEMENT

N (R10)

AS (R11)

FORMATI / SIZES / FORMATE / FORMATS
PEZZI SPECIALI / TRIMS / FORMTEILE / PIÈCES SPÉCIALES

pag. 417
pag. 417

EARTH

CON.CREA.

RETTIFICATO MONOCALIBRO
RECTIFIED SINGLE-CALIBRE / REKTIFIZIERT EINKALIBRIG /
RECTIFIÉ MONOCALIBRE

FORMATI
SIZES / FORMATE / FORMATS

SPESSORE
THICKNESS / DICKE / ÉPAISSEUR

ULTRA 6 mm
ABSORBA GREAT SURFACES

SPESSORE
THICKNESS / DICKE / ÉPAISSEUR

9 mm

120 x 60 cm
48" x 24"



60 x 60 cm
24" x 24"



60 x 30 cm
24" x 12"

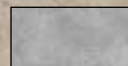

SPESSORE
THICKNESS / DICKE / ÉPAISSEUR

2 cm

120 x 60 cm
48" x 24"

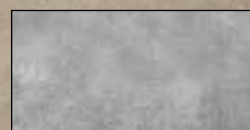

60 x 60 cm
24" x 24"



SUPERFICI
SURFACES
OBERFLÄCHEN
SURFACES

NATURALE / NATURAL / NATURBELASSEN / NATUREL

ANTISCIVOLO / ANTISLIP

PRELUCIDATO

COEFFICIENTE DI ATTRITO
FRICTION COEFFICIENT
REIBUNGSKOEFFIZIENT
COEFFICIENT DE FROTTEMENT

N (R10)

AS (R11)

FORMATI / SIZES / FORMATE / FORMATS
PEZZI SPECIALI / TRIMS / FORMTEILE / PIÈCES SPÉCIALES

pag. 417
pag. 417

INK

CON.CREA.

RETTIFICATO MONOCALIBRO

RECTIFIED SINGLE-CALIBRE / REKTIFIZIERT EINKALIBRIG /
RECTIFIÉ MONOCALIBRE

FORMATI

SIZES / FORMATE / FORMATS

SPESSORE

THICKNESS / DICKE / ÉPAISSEUR

ULTRA®
ARBOREA GREAT SURFACES

6 mm

SPESSORE

THICKNESS / DICKE / ÉPAISSEUR

9 mm

120 x 60 cm
48" x 24"



60 x 60 cm
24" x 24"

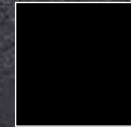

60 x 30 cm
24" x 12"



SPESSORE

THICKNESS / DICKE / ÉPAISSEUR

cm2

120 x 60 cm
48" x 24"

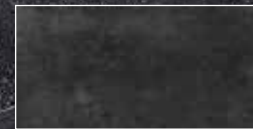

60 x 60 cm
24" x 24"

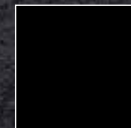

SUPERFICI
SURFACES
OBERFLÄCHEN
SURFACES

NATURALE / NATURAL / NATURBELASSEN / NATUREL

ANTISCIVOLO / ANTISLIP

PRELUCIDATO

COEFFICIENTE DI ATTRITO

FRICTION COEFFICIENT
REIBUNGSKOEFFIZIENT
COEFFICIENT DE FROTTEMENT

N (R10)

AS (R11)

FORMATI / SIZES / FORMATE / FORMATS
PEZZI SPECIALI / TRIMS / FORMTEILE / PIÈCES SPÉCIALES

pag. 417
pag. 417

TALC

CON.CREA.

RETTIFICATO MONOCALIBRO
RECTIFIED SINGLE-CALIBRE / REKTIFIZIERT EINKALIBRIG /
RECTIFIÉ MONOCALIBRE

FORMATI
SIZES / FORMATE / FORMATS

SPESSORE
THICKNESS / DICKE / ÉPAISSEUR

ULTRA  **6 mm**
ARBOREA GREAT SURFACES

SPESSORE
THICKNESS / DICKE / ÉPAISSEUR

9 mm

120 x 60 cm
48" x 24"

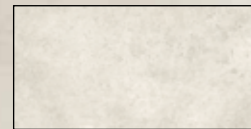

60 x 60 cm
24" x 24"

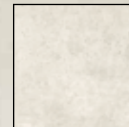

60 x 30 cm
24" x 12"



SPESSORE
THICKNESS / DICKE / ÉPAISSEUR

2 cm

120 x 60 cm
48" x 24"

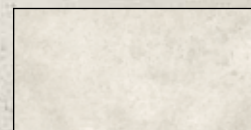

60 x 60 cm
24" x 24"

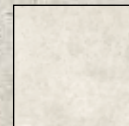

SUPERFICI
SURFACES
OBERFLÄCHEN
SURFACES

NATURALE / NATURAL / NATURBELASSEN / NATUREL

ANTISCIVOLO / ANTISLIP

PRELUCIDATO

COEFFICIENTE DI ATTRITO
FRICTION COEFFICIENT
REIBUNGSKOEFFIZIENT
COEFFICIENT DE FROTTEMENT

N 

AS 

FORMATI / SIZES / FORMATE / FORMATS
PEZZI SPECIALI / TRIMS / FORMTEILE / PIÈCES SPÉCIALES

pag. 417
pag. 417

DOVE GREY

CON.CREA.

RETTIFICATO MONOCALIBRO
RECTIFIED SINGLE-CALIBRE / REKTIFIZIERT EINKALIBRIG /
RECTIFIÉ MONOCALIBRE

FORMATI
SIZES / FORMATE / FORMATS

SPESSORE
THICKNESS / DICKE / ÉPAISSEUR

ULTRA  **6 mm**
ABSORBA GREAT SURFACES

SPESSORE
THICKNESS / DICKE / ÉPAISSEUR

9 mm

120 x 60 cm
48" x 24"



60 x 60 cm
24" x 24"



60 x 30 cm
24" x 12"



SPESSORE
THICKNESS / DICKE / ÉPAISSEUR

2 cm

120 x 60 cm
48" x 24"



60 x 60 cm
24" x 24"



SUPERFICI
SURFACES
OBERFLÄCHEN
SURFACES

NATURALE / NATURAL / NATURBELASSEN / NATUREL

ANTISCIVOLO / ANTISLIP

PRELUCIDATO

COEFFICIENTE DI ATTRITO
FRICTION COEFFICIENT
REIBUNGSKOEFFIZIENT
COEFFICIENT DE FROTTEMENT

N (R10)

AS (R11)

FORMATI / SIZES / FORMATE / FORMATS
PEZZI SPECIALI / TRIMS / FORMTEILE / PIÈCES SPÉCIALES

pag. 417
pag. 417



PEARL	238
LIGHT GREY	240
SMOKE	242
TAUPE	244
TOBACCO	246
SOFT BLACK	248

TEKNOSTONE

PEARL

TEKNOSTONE

RETTIFICATO MONOCALIBRO
RECTIFIED SINGLE-CALIBRE / REKTIFIZIERT EINKALIBRIG /
RECTIFIÉ MONOCALIBRE

FORMATI
SIZES / FORMATE / FORMATS

SPESSORE
THICKNESS / DICKE / ÉPAISSEUR

▼
6 mm
▲

150 x 75 cm
60" x 30"



75 x 75 cm
30" x 30"



SPESSORE
THICKNESS / DICKE / ÉPAISSEUR

▼
8 mm
▲

120 x 60 cm
48" x 24"



60 x 60 cm
24" x 24"

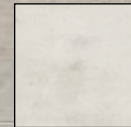

60 x 30 cm
24" x 12"

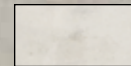

SUPERFICI
SURFACES
OBERFLÄCHEN
SURFACES

NATURALE / NATURAL / NATURBELASSEN / NATUREL

COEFFICIENTE DI ATTRITO
FRICTION COEFFICIENT
REIBUNGSKOEFFIZIENT
COEFFICIENT DE FROTTEMENT

N (R10) A+B

FORMATI / SIZES / FORMATE / FORMATS
PEZZI SPECIALI / TRIMS / FORMTEILE / PIÈCES SPÉCIALES
DECORI E MOSAICI / DECORS AND MOSAICS / DEKORE UND MOSAIKE / DECORS ET MOSAÏQUE

pag. 418
pag. 418
pag. 418

LIGHT GREY

TEKNOSTONE

RETTIFICATO MONOCALIBRO
RECTIFIED SINGLE-CALIBRE / REKTIFIZIERT EINKALIBRIG /
RECTIFIÉ MONOCALIBRE

FORMATI
SIZES / FORMATE / FORMATS

SPESSORE
THICKNESS / DICKE / ÉPAISSEUR

ULTRA
ARABIA CERAMICS
6 mm

150 x 75 cm
60" x 30"



75 x 75 cm
30" x 30"



SPESSORE
THICKNESS / DICKE / ÉPAISSEUR

8 mm

cm²

120 x 60 cm
48" x 24"



60 x 60 cm
24" x 24"



60 x 30 cm
24" x 12"



SUPERFICI
SURFACES
OBERFLÄCHEN
SURFACES

NATURALE / NATURAL / NATURBELASSEN / NATUREL
ANTISLIP

COEFFICIENTE DI ATTRITO
FRICTION COEFFICIENT
REIBUNGSKOEFFIZIENT
COEFFICIENT DE FROTTEMENT

N (R10) A+B

AS (R11) A+B

FORMATI / SIZES / FORMATE / FORMATS
PEZZI SPECIALI / TRIMS / FORMTEILE / PIÈCES SPÉCIALES
DECORI E MOSAICI / DECORS AND MOSAICS / DEKORE UND MOSAIKE / DECORS ET MOSAÏQUE

pag. 418
pag. 418
pag. 418

SMOKE

TEKNOSTONE

RETTIFICATO MONOCALIBRO
RECTIFIED SINGLE-CALIBRE / REKTIFIZIERT EINKALIBRIG /
RECTIFIÉ MONOCALIBRE

FORMATI
SIZES / FORMATE / FORMATS

SPESSORE
THICKNESS / DICKE / ÉPAISSEUR

ULTRA
6 mm

150 x 75 cm
60" x 30"



75 x 75 cm
30" x 30"



SPESSORE
THICKNESS / DICKE / ÉPAISSEUR

8 mm

cm²

120 x 60 cm
48" x 24"



60 x 60 cm
24" x 24"



60 x 30 cm
24" x 12"



SUPERFICI
SURFACES
OBERFLÄCHEN
SURFACES

NATURALE / NATURAL / NATURBELASSEN / NATUREL
ANTISLIP

COEFFICIENTE DI ATTRITO
FRICTION COEFFICIENT
REIBUNGSKOEFFIZIENT
COEFFICIENT DE FROTTEMENT

N (R10) A+B

AS (R11) A+B

TAUPE

TEKNOSTONE

RETTIFICATO MONOCALIBRO
RECTIFIED SINGLE-CALIBRE / REKTIFIZIERT EINKALIBRIG /
RECTIFIÉ MONOCALIBRE

FORMATI
SIZES / FORMATE / FORMATS

SPESSORE
THICKNESS / DICKE / ÉPAISSEUR

ULTRA
6 mm

150 x 75 cm
60" x 30"



75 x 75 cm
30" x 30"



SPESSORE
THICKNESS / DICKE / ÉPAISSEUR

8 mm

120 x 60 cm
48" x 24"



60 x 60 cm
24" x 24"



60 x 30 cm
24" x 12"

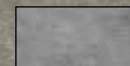

SUPERFICI
SURFACES
OBERFLÄCHEN
SURFACES

NATURALE / NATURAL / NATURBELASSEN / NATUREL

COEFFICIENTE DI ATTRITO
FRICTION COEFFICIENT
REIBUNGSKOEFFIZIENT
COEFFICIENT DE FROTTEMENT

N (R10) A+B

FORMATI / SIZES / FORMATE / FORMATS
PEZZI SPECIALI / TRIMS / FORMTEILE / PIÈCES SPÉCIALES
DECORI E MOSAICI / DECORS AND MOSAICS / DEKORE UND MOSAIKE / DECORS ET MOSAÏQUE

pag. 418
pag. 418
pag. 418

TOBACCO

TEKNOSTONE

RETTIFICATO MONOCALIBRO
RECTIFIED SINGLE-CALIBRE / REKTIFIZIERT EINKALIBRIG /
RECTIFIÉ MONOCALIBRE

FORMATI
SIZES / FORMATE / FORMATS

SPESSORE
THICKNESS / DICKE / ÉPAISSEUR

ULTRA
6 mm

150 x 75 cm
60" x 30"

75 x 75 cm
30" x 30"

SPESSORE
THICKNESS / DICKE / ÉPAISSEUR

8 mm

120 x 60 cm
48" x 24"

60 x 60 cm
24" x 24"

60 x 30 cm
24" x 12"

SUPERFICI
SURFACES
OBERFLÄCHEN
SURFACES

COEFFICIENTE DI ATTRITO
FRICTION COEFFICIENT
REIBUNGSKOEFFIZIENT
COEFFICIENT DE FROTTEMENT

FORMATI / SIZES / FORMATE / FORMATS
PEZZI SPECIALI / TRIMS / FORMTEILE / PIÈCES SPÉCIALES

DECORI E MOSAICI / DECORS AND MOSAICS / DEKORE UND MOSAIKE / DECORS ET MOSAÏQUE

NATURALE / NATURAL / NATURBELASSEN / NATUREL

N (R10) A+B

pag. 418
pag. 418
pag. 418

SOFT BLACK

TEKNOSTONE

RETTIFICATO MONOCALIBRO
RECTIFIED SINGLE-CALIBRE / REKTIFIZIERT EINKALIBRIG /
RECTIFIÉ MONOCALIBRE

FORMATI
SIZES / FORMATE / FORMATS

SPESSORE
THICKNESS / DICKE / ÉPAISSEUR

6 mm

150 x 75 cm
60" x 30"

75 x 75 cm
30" x 30"

SPESSORE
THICKNESS / DICKE / ÉPAISSEUR

8 mm

cm²

120 x 60 cm
48" x 24"

60 x 60 cm
24" x 24"

60 x 30 cm
24" x 12"

SUPERFICI
SURFACES
OBERFLÄCHEN
SURFACES

COEFFICIENTE DI ATTRITO
FRICTION COEFFICIENT
REIBUNGSKOEFFIZIENT
COEFFICIENT DE FROTTEMENT

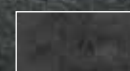

NATURALE / NATURAL / NATURBELASSEN / NATUREL

ANTISLIP

N (R10) A+B

AS (R11) A+B

pag. 418

pag. 418

pag. 418

FORMATI / SIZES / FORMATE / FORMATS
PEZZI SPECIALI / TRIMS / FORMTEILE / PIÈCES SPÉCIALES
DECORI E MOSAICI / DECORS AND MOSAICS / DEKORE UND MOSAIKE / DECORS ET MOSAÏQUE

DUST	252
FOG	254
COAL	256
JUTA	258
PITCH	260

NORTHSTONE



DUST

NORTHSTONE

RETTIFICATO MONOCALIBRO

RECTIFIED SINGLE-CALIBRE / REKTIFIZIERT EINKALIBRIG /
RECTIFIÉ MONOCALIBRE

SPESSORE

THICKNESS / DICKE / ÉPAISSEUR

▼
9 mm
▲

FORMATI

SIZES / FORMATE / FORMATS

120 x 60 cm
48" x 24"



60 x 60 cm
24" x 24"



60 x 30 cm
24" x 12"



SUPERFICI / SURFACES / OBERFLÄCHEN / SURFACES

LEVIGATO SILK

NATURALE

COEFFICIENTE DI ATTRITO

FRICITION COEFFICIENT
REIBUNGSKOEFFIZIENT
COEFFICIENT DE FROTTEMENT

N (R10) A+B

FORMATI pag. 418

SIZES pag. 418 / FORMATE pag. 418 / FORMATS pag. 418

PEZZI SPECIALI pag. 418

TRIMS pag. 418 / FORMTEILE pag. 418 / PIÈCES SPÉCIALES pag. 418



FOG

NORTHSTONE

RETTIFICATO MONOCALIBRO

RECTIFIED SINGLE-CALIBRE / REKTIFIZIERT EINKALIBRIG /
RECTIFIÉ MONOCALIBRE

SPESSORE

THICKNESS / DICKE / ÉPAISSEUR

▼
9 mm
▲

FORMATI

SIZES / FORMATE / FORMATS

120 x 60 cm

48" x 24"



60 x 60 cm

24" x 24"



60 x 30 cm

24" x 12"



SUPERFICI / SURFACES / OBERFLÄCHEN / SURFACES

LEVIGATO SILK

NATURALE

COEFFICIENTE DI ATTRITO

FRICITION COEFFICIENT
REIBUNGSKOEFFIZIENT
COEFFICIENT DE FROTTEMENT

N (R10) A+B

FORMATI pag. 418

SIZES pag. 418 / FORMATE pag. 418 / FORMATS pag. 418

PEZZI SPECIALI pag. 418

TRIMS pag. 418 / FORMTEILE pag. 418 / PIÈCES SPÉCIALES pag. 418



COAL

NORTHSTONE

RETTIFICATO MONOCALIBRO

RECTIFIED SINGLE-CALIBRE / REKTIFIZIERT EINKALIBRIG /
RECTIFIÉ MONOCALIBRE

SPESSORE

THICKNESS / DICKE / ÉPAISSEUR

▼
9 mm
▲

FORMATI

SIZES / FORMATE / FORMATS

120 x 60 cm

48" x 24"



60 x 60 cm

24" x 24"



60 x 30 cm

24" x 12"



SUPERFICI / SURFACES / OBERFLÄCHEN / SURFACES

LEVIGATO SILK

NATURALE

COEFFICIENTE DI ATTRITO

FRICITION COEFFICIENT
REIBUNGSKOEFFIZIENT
COEFFICIENT DE FROTTEMENT

N (R10) A+B

FORMATI pag. 418

SIZES pag. 418 / FORMATE pag. 418 / FORMATS pag. 418

PEZZI SPECIALI pag. 418

TRIMS pag. 418 / FORMTEILE pag. 418 / PIÈCES SPÉCIALES pag. 418

JUTA

NORTHSTONE

RETTIFICATO MONOCALIBRO

RECTIFIED SINGLE-CALIBRE / REKTIFIZIERT EINKALIBRIG /
RECTIFIÉ MONOCALIBRE

SPESSORE

THICKNESS / DICKE / ÉPAISSEUR

▼
9 mm
▲

FORMATI

SIZES / FORMATE / FORMATS

120 x 60 cm

48" x 24"



60 x 60 cm

24" x 24"



60 x 30 cm

24" x 12"



SUPERFICI / SURFACES / OBERFLÄCHEN / SURFACES

LEVIGATO SILK

NATURALE

COEFFICIENTE DI ATTRITO

FRICTION COEFFICIENT

REIBUNGSKOEFFIZIENT

COEFFICIENT DE FROTTEMENT

N (R10) A+B

FORMATI pag. 418

SIZES pag. 418 / FORMATE pag. 418 / FORMATS pag. 418

PEZZI SPECIALI pag. 418

TRIMS pag. 418 / FORMTEILE pag. 418 / PIÈCES SPÉCIALES pag. 418

PITCH

NORTHSTONE

RETTIFICATO MONOCALIBRO

RECTIFIED SINGLE-CALIBRE / REKTIFIZIERT EINKALIBRIG /
RECTIFIÉ MONOCALIBRE

SPESSORE

THICKNESS / DICKE / ÉPAISSEUR

▼
9 mm
▲

FORMATI

SIZES / FORMATE / FORMATS

120 x 60 cm

48" x 24"



60 x 60 cm

24" x 24"



60 x 30 cm

24" x 12"

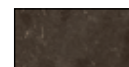

SUPERFICI / SURFACES / OBERFLÄCHEN / SURFACES

LEVIGATO SILK

NATURALE

COEFFICIENTE DI ATTRITO

FRICITION COEFFICIENT
REIBUNGSKOEFFIZIENT
COEFFICIENT DE FROTTEMENT

N (R10) A+B

FORMATI pag. 418

SIZES pag. 418 / FORMATE pag. 418 / FORMATS pag. 418

PEZZI SPECIALI pag. 418

TRIMS pag. 418 / FORMTEILE pag. 418 / PIÈCES SPÉCIALES pag. 418

GESSO	264
SABBIA	266
CENERE	268
FANGO	270
LAVA	272
GHIACCIO	274
DIORITE	276
PELTRO	278
LIGNITE	280

MATERIE HIGH-TECH

GESSO

MATERIE HIGH_TECH

RETTIFICATO MONOCALIBRO
RECTIFIED SINGLE-CALIBRE / REKTIFIZIERT EINKALIBRIG /
RECTIFIÉ MONOCALIBRE

FORMATI
SIZES / FORMATE / FORMATS

SPESSORE
THICKNESS / DICKE / ÉPAISSEUR

▼
6 mm
▲

150 x 75 cm
60" x 30"

75 x 75 cm
30" x 30"

SUPERFICI
SURFACES
OBERFLÄCHEN
SURFACES

COEFFICIENTE DI ATTRITO
FRICTION COEFFICIENT
REIBUNGSKOEFFIZIENT
COEFFICIENT DE FROTTEMENT

SPESSORE
THICKNESS / DICKE / ÉPAISSEUR

▼
10 mm
▲

120 x 60 cm
48" x 24"

60 x 60 cm
24" x 24"

60 x 30 cm
24" x 12"

SUPERFICI
SURFACES
OBERFLÄCHEN
SURFACES

COEFFICIENTE DI ATTRITO
FRICTION COEFFICIENT
REIBUNGSKOEFFIZIENT
COEFFICIENT DE FROTTEMENT

FORMATI / SIZES / FORMATE / FORMATS
PEZZI SPECIALI / TRIMS / FORMTEILE / PIÈCES SPÉCIALES



SOFT

SO (R9)

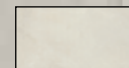

SOFT

NATURALE / NATURAL / NATURBELASSEN / NATUREL

SO (R9)

N (R10) A+B

pag. 419
pag. 419

SABBIA

MATERIE HIGH_TECH

RETTIFICATO MONOCALIBRO
RECTIFIED SINGLE-CALIBRE / REKTIFIZIERT EINKALIBRIG /
RECTIFIÉ MONOCALIBRE

FORMATI
SIZES / FORMATE / FORMATS

SPESSORE
THICKNESS / DICKE / ÉPAISSEUR

▼
6 mm
▲

150 x 75 cm
60" x 30"



75 x 75 cm
30" x 30"



SUPERFICI
SURFACES
OBERFLÄCHEN
SURFACES

SOFT

COEFFICIENTE DI ATTRITO
FRICTION COEFFICIENT
REIBUNGSKOEFFIZIENT
COEFFICIENT DE FROTTEMENT

SO (R9)

SPESSORE
THICKNESS / DICKE / ÉPAISSEUR

▼
10 mm
▲

120 x 60 cm
48" x 24"



60 x 60 cm
24" x 24"



60 x 30 cm
24" x 12"

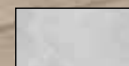

SUPERFICI
SURFACES
OBERFLÄCHEN
SURFACES

SOFT

NATURALE / NATURAL / NATURBELASSEN / NATUREL

COEFFICIENTE DI ATTRITO
FRICTION COEFFICIENT
REIBUNGSKOEFFIZIENT
COEFFICIENT DE FROTTEMENT

SO (R9)

N (R10) A+B

CENERE

MATERIE HIGH_TECH

RETTIFICATO MONOCALIBRO
RECTIFIED SINGLE-CALIBRE / REKTIFIZIERT EINKALIBRIG /
RECTIFIÉ MONOCALIBRE

FORMATI
SIZES / FORMATE / FORMATS

SPESSORE
THICKNESS / DICKE / ÉPAISSEUR

▼
6 mm
▲

150 x 75 cm
60" x 30"



75 x 75 cm
30" x 30"



SUPERFICI
SURFACES
OBERFLÄCHEN
SURFACES

SOFT

COEFFICIENTE DI ATTRITO
FRICTION COEFFICIENT
REIBUNGSKOEFFIZIENT
COEFFICIENT DE FROTTEMENT

SO (R9)

SPESSORE
THICKNESS / DICKE / ÉPAISSEUR

▼
10 mm
▲

cm²

120 x 60 cm
48" x 24"



60 x 60 cm
24" x 24"



60 x 30 cm
24" x 12"

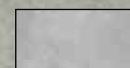

SUPERFICI
SURFACES
OBERFLÄCHEN
SURFACES

SOFT

NATURALE / NATURAL / NATURBELASSEN / NATUREL

ANTISLIP

COEFFICIENTE DI ATTRITO
FRICTION COEFFICIENT
REIBUNGSKOEFFIZIENT
COEFFICIENT DE FROTTEMENT

SO (R9)

N (R10) A+B

AS (R11) A+B

FANGO

MATERIE HIGH_TECH

RETTIFICATO MONOCALIBRO
RECTIFIED SINGLE-CALIBRE / REKTIFIZIERT EINKALIBRIG /
RECTIFIÉ MONOCALIBRE

FORMATI
SIZES / FORMATE / FORMATS

SPESSORE
THICKNESS / DICKE / ÉPAISSEUR

▼
6 mm
▲

150 x 75 cm
60" x 30"



75 x 75 cm
30" x 30"



SUPERFICI
SURFACES
OBERFLÄCHEN
SURFACES

SOFT

COEFFICIENTE DI ATTRITO
FRICTION COEFFICIENT
REIBUNGSKOEFFIZIENT
COEFFICIENT DE FROTTEMENT

SO (R9)

SPESSORE
THICKNESS / DICKE / ÉPAISSEUR

▼
10 mm
▲
çm2

120 x 60 cm
48" x 24"



60 x 60 cm
24" x 24"



60 x 30 cm
24" x 12"



SUPERFICI
SURFACES
OBERFLÄCHEN
SURFACES

SOFT

COEFFICIENTE DI ATTRITO
FRICTION COEFFICIENT
REIBUNGSKOEFFIZIENT
COEFFICIENT DE FROTTEMENT

NATURALE / NATURAL / NATURBELASSEN / NATUREL
ANTISLIP

SO (R9)

N (R10) A+B

AS (R11) A+B

LAVA

MATERIE HIGH_TECH

RETTIFICATO MONOCALIBRO
RECTIFIED SINGLE-CALIBRE / REKTIFIZIERT EINKALIBRIG /
RECTIFIÉ MONOCALIBRE

SPESSORE
THICKNESS / DICKE / ÉPAISSEUR

10 mm

FORMATI
SIZES / FORMATE / FORMATS

120 x 60 cm
48" x 24"

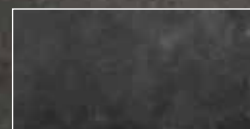

60 x 60 cm
24" x 24"

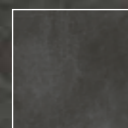

60 x 30 cm
24" x 12"

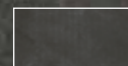

SUPERFICI
SURFACES
OBERFLÄCHEN
SURFACES

SOFT

NATURALE / NATURAL / NATURBELASSEN / NATUREL

COEFFICIENTE DI ATTRITO
FRICTION COEFFICIENT
REIBUNGSKOEFFIZIENT
COEFFICIENT DE FROTTEMENT

SO (R9)

N (R10) A+B

GHIACCIO

MATERIE HIGH_TECH

RETTIFICATO MONOCALIBRO
RECTIFIED SINGLE-CALIBRE / REKTIFIZIERT EINKALIBRIG /
RECTIFIÉ MONOCALIBRE

SPESSORE
THICKNESS / DICKE / ÉPAISSEUR

▼
10 mm
▲

FORMATI
SIZES / FORMATE / FORMATS

120 x 60 cm
48" x 24"

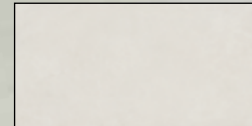

60 x 60 cm
24" x 24"

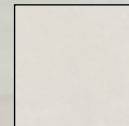

60 x 30 cm
24" x 12"

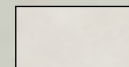

SUPERFICI
SURFACES
OBERFLÄCHEN
SURFACES

SOFT

NATURALE / NATURAL / NATURBELASSEN / NATUREL

COEFFICIENTE DI ATTRITO
FRICTION COEFFICIENT
REIBUNGSKOEFFIZIENT
COEFFICIENT DE FROTTEMENT

SO (R9)

N (R10) A+B

DIORITE

MATERIE HIGH_TECH

RETTIFICATO MONOCALIBRO
RECTIFIED SINGLE-CALIBRE / REKTIFIZIERT EINKALIBRIG /
RECTIFIÉ MONOCALIBRE

SPESSORE
THICKNESS / DICKE / ÉPAISSEUR

10 mm
cm²

FORMATI
SIZES / FORMATE / FORMATS

120 x 60 cm
48" x 24"

60 x 60 cm
24" x 24"

60 x 30 cm
24" x 12"

SUPERFICI
SURFACES
OBERFLÄCHEN
SURFACES

COEFFICIENTE DI ATTRITO
FRICTION COEFFICIENT
REIBUNGSKOEFFIZIENT
COEFFICIENT DE FROTTEMENT

SOFT

NATURALE / NATURAL / NATURBELASSEN / NATUREL

ANTISLIP

SO (R9)

N (R10) A+B

AS (R11) A+B

PELTRO

MATERIE HIGH_TECH

RETTIFICATO MONOCALIBRO
RECTIFIED SINGLE-CALIBRE / REKTIFIZIERT EINKALIBRIG /
RECTIFIÉ MONOCALIBRE

SPESSORE
THICKNESS / DICKE / ÉPAISSEUR

10 mm
cm²

FORMATI
SIZES / FORMATE / FORMATS

120 x 60 cm
48" x 24"



60 x 60 cm
24" x 24"



60 x 30 cm
24" x 12"



SUPERFICI
SURFACES
OBERFLÄCHEN
SURFACES

SOFT

NATURALE / NATURAL / NATURBELASSEN / NATUREL

ANTISLIP

COEFFICIENTE DI ATTRITO
FRICTION COEFFICIENT
REIBUNGSKOEFFIZIENT
COEFFICIENT DE FROTTEMENT

SO (R9)

N (R10) A+B

AS (R11) A+B

LIGNITE

MATERIE HIGH_TECH

RETTIFICATO MONOCALIBRO
RECTIFIED SINGLE-CALIBRE / REKTIFIZIERT EINKALIBRIG /
RECTIFIÉ MONOCALIBRE

SPESSORE
THICKNESS / DICKE / ÉPAISSEUR

▼
10 mm
▲

FORMATI
SIZES / FORMATE / FORMATS

120 x 60 cm
48"x 24"

60 x 60 cm
24"x 24"

60 x 30 cm
24"x 12"

SUPERFICI
SURFACES
OBERFLÄCHEN
SURFACES

COEFFICIENTE DI ATTRITO
FRICTION COEFFICIENT
REIBUNGSKOEFFIZIENT
COEFFICIENT DE FROTTEMENT



SOFT

NATURALE / NATURAL / NATURBELASSEN / NATUREL

SO (R9)

N (R10) A+B

QUARZITE BIANCA	284
LIMRA	286
CREMA EUROPA	288
PIETRA DI BARGE	290
PIETRA GIALLA	292
PIETRA SINTRA	294
PIETRA DI BORGOGNA	296
SILK GEORGETTE	298
PIETRA PIASENTINA	300
PIETRA D'AVOLA	302
PIETRA DI RAGUSA	304
PIETRA DI LUSERNA	306
BASALTO GRIGIO	308
ARDESIA ANTRACITE	310
BLACK ARDESIA	312
CADAPPA BLACK	314

PIETRE NATURALI HIGH-TECH

QUARZITE BIANCA

PROVENIENZA ARABIA SAUDITA
ORIGIN SAUDI ARABIA / HERKUNFT SAUDI-ARABIEN /
PROVENANCE ARABIE SAOUDITE

REPERIBILITÀ BUONA
AVAILABILITY GOOD /
VERFÜGBARKEIT REICHLICH /
DISPONIBILITÉ BONNE

RETTIFICATO MONOCALIBRO
RECTIFIED SINGLE-CALIBRE / REKTIFIZIERT EINKALIBRIG /
RECTIFIÉ MONOCALIBRE

SPESORE
THICKNESS / DICKE / ÉPAISSEUR

▼
10mm
▲

FORMATI
SIZES / FORMATE / FORMATS

120 x 60 cm
48" x 24"

60 x 60 cm
24" x 24"

60 x 30 cm
24" x 12"

60 x 15 cm
24" x 6"

SUPERFICI
SURFACES
OBERFLÄCHEN
SURFACES

COEFFICIENTE DI ATTRITO
FRICTION COEFFICIENT
REIBUNGSKOEFFIZIENT
COEFFICIENT DE FROTTEMENT

FORMATI / SIZES / FORMATE / FORMATS

PEZZI SPECIALI / TRIMS / FORMTEILE / PIÈCES SPÉCIALES

DECORI E MOSAICI / DECORS AND MOSAICS / DEKORE UND MOSAIKE / DECORS ET MOSAÏQUE

GREENSTONE

DI FABBRICA

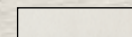
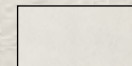
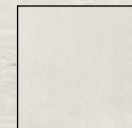
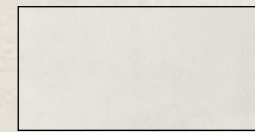

STRUTTURATO / STRUCTURED / STRUKTURIERT / STRUCTURÉ
SEMILUCIDATO / SEMI-POLISHED / SEMI-MATT / SEMI-LUSTRÉ

ST (R11) A+B+C

SL (R10) A

pag. 420

pag. 420/421

pag. 420

LIMRA

PIETRE NATURALI HIGH-TECH

PROVENIENZA TURCHIA

ORIGIN TURKEY / HERKUNFT TÜRKEI /
PROVENANCE TURQUIE

REPERIBILITÀ MODESTA

AVAILABILITY SCARCE /
VERFÜGBARKEIT BESCHIEDEN /
DISPONIBILITÉ MODESTE

RETTIFICATO MONOCALIBRO

RECTIFIED SINGLE-CALIBRE / REKTIFIZIERT EINKALIBRIG /
RECTIFIÉ MONOCALIBRE

SPESSORE

THICKNESS / DICKE / ÉPAISSEUR

▼
10mm
▲

FORMATI

SIZES / FORMATE / FORMATS

120 x 60 cm
48" x 24"



90 x 45 cm
36" x 17^{3/4}"

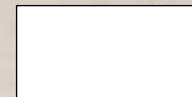

60 x 60 cm
24" x 24"



60 x 30 cm
24" x 12"

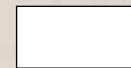

60 x 15 cm
24" x 6"

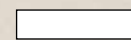

SUPERFICI

SURFACES
OBERFLÄCHEN
SURFACES

STRUTTURATO / STRUCTURED / STRUKTURIERT / STRUCTURÉ

SATINATO / SATIN-FINISH / SATINIERT / SATINÉ

COEFFICIENTE DI ATTRITO

FRICTION COEFFICIENT
REIBUNGSKOEFFIZIENT
COEFFICIENT DE FROTTEMENT

ST (R11) A+B+C

SA (R10) A+B

FORMATI / SIZES / FORMATE / FORMATS

PEZZI SPECIALI / TRIMS / FORMTEILE / PIÈCES SPÉCIALES

DECORI E MOSAICI / DECORS AND MOSAICS / DEKORE UND MOSAIKE / DECORS ET MOSAÏQUE

pag. 420

pag. 420/421

pag. 420

CREMA EUROPA

PIETRE NATURALI HIGH-TECH

PROVENIENZA FRANCIA

ORIGIN FRANCE / HERKUNFT FRANKREICH /
PROVENANCE FRANCE

REPERIBILITÀ BUONA

AVAILABILITY GOOD /
VERFÜGBARKEIT REICHLICH /
DISPONIBILITÉ BONNE

RETTIFICATO MONOCALIBRO

RECTIFIED SINGLE-CALIBRE / REKTIFIZIERT EINKALIBRIG /
RECTIFIÉ MONOCALIBRE

SPESSORE

THICKNESS / DICKE / ÉPAISSEUR

10mm

cm²

FORMATI

SIZES / FORMATE / FORMATS

120 x 60 cm
48" x 24"

90 x 45 cm
36" x 17^{3/4}"

60 x 60 cm
24" x 24"

60 x 30 cm
24" x 12"

60 x 15 cm
24" x 6"

DI FABBRICA

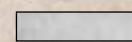
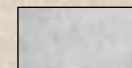
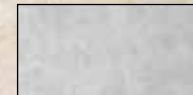
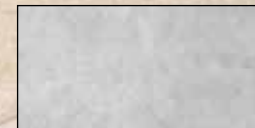

SUPERFICI

SURFACES
OBERFLÄCHEN
SURFACES

STRUTTURATO / STRUCTURED / STRUKTURIERT / STRUCTURÉ

SATINATO / SATIN-FINISH / SATINIERT / SATINÉ

COEFFICIENTE DI ATTRITO

FRICTION COEFFICIENT
REIBUNGSKOEFFIZIENT
COEFFICIENT DE FROTTEMENT

ST (R11) A+B

SA (R9)

FORMATI / SIZES / FORMATE / FORMATS

PEZZI SPECIALI / TRIMS / FORMTEILE / PIÈCES SPÉCIALES

DECORI E MOSAICI / DECORS AND MOSAICS / DEKORE UND MOSAIKE / DECORS ET MOSAÏQUE

pag. 420

pag. 420/421

pag. 420

PIETRA DI BARGE

PIETRE NATURALI HIGH-TECH

PROVENIENZA BRASILE

ORIGIN BRAZIL / HERKUNFT BRASIL /
PROVENANCE BRÉSIL

REPERIBILITÀ ESTREMAMENTE LIMITATA

AVAILABILITY VERY SCARCE /
VERFÜGBARKEIT ÄUSSERST BEGRENZT /
DISPONIBILITÉ EXTRÊ MEMENT LIMITÉE

RETTIFICATO MONOCALIBRO

RECTIFIED SINGLE-CALIBRE / REKTIFIZIERT EINKALIBRIG /
RECTIFIÉ MONOCALIBRE

SPESSORE

THICKNESS / DICKE / ÉPAISSEUR

▼
10mm
▲

FORMATI

SIZES / FORMATE / FORMATS

60 x 60 cm
24" x 24"

60 x 30 cm
24" x 12"

60 x 15 cm
24" x 6"

DI FABBRICA

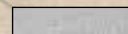
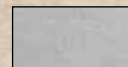

SUPERFICI

SURFACES
OBERFLÄCHEN
SURFACES

STRUTTURATO / STRUCTURED / STRUKTURIERT / STRUCTURÉ

SATINATO / SATIN-FINISH / SATINIERT / SATINÉ

COEFFICIENTE DI ATTRITO

FRICTION COEFFICIENT
REIBUNGSKOEFFIZIENT
COEFFICIENT DE FROTTEMENT

ST (R11) A+B

SA (R9)

FORMATI / SIZES / FORMATE / FORMATS

PEZZI SPECIALI / TRIMS / FORMTEILE / PIÈCES SPÉCIALES

DECORI E MOSAICI / DECORS AND MOSAICS / DEKORE UND MOSAIKE / DECORS ET MOSAÏQUE

pag. 420

pag. 420/421

pag. 420



PIETRA GIALLA

PIETRE NATURALI HIGH-TECH

PROVENIENZA GERMANIA

ORIGIN GERMANY / HERKUNFT DEUTSCHLAND /
PROVENANCE ALLEMAGNE

REPERIBILITÀ BUONA

AVAILABILITY GOOD /
VERFÜGBARKEIT REICHLICH /
DISPONIBILITÉ BONNE

RETTIFICATO MONOCALIBRO

RECTIFIED SINGLE-CALIBRE / REKTIFIZIERT EINKALBRIG /
RECTIFIÉ MONOCALIBRE

SPESSORE

THICKNESS / DICKE / ÉPAISSEUR

▼
10mm
▲

FORMATI

SIZES / FORMATE / FORMATS

60 x 30 cm
24" x 12"



60 x 15 cm
24" x 6"



SUPERFICI

SURFACES
OBERFLÄCHEN
SURFACES

STRUTTURATO / STRUCTURED / STRUKTURIERT / STRUCTURÉ

SATINATO / SATIN-FINISH / SATINIERT / SATINÉ

COEFFICIENTE DI ATTRITO

FRICTION COEFFICIENT
REIBUNGSKOEFFIZIENT
COEFFICIENT DE FROTTEMENT

ST (R11) A+B

SA (R9)

FORMATI / SIZES / FORMATE / FORMATS

PEZZI SPECIALI / TRIMS / FORMTEILE / PIÈCES SPÉCIALES

DECORI E MOSAICI / DÉCORS AND MOSAICS / DEKORE UND MOSAIKE / DÉCORS ET MOSAÏQUE

pag. 420

pag. 420/421

pag. 420

PIETRA SINTRA

GREENSTONE

PROVENIENZA PORTOGALLO
ORIGIN PORTUGAL / HERKUNFT PORTUGAL /
PROVENANCE PORTUGAL

REPERIBILITÀ BUONA
AVAILABILITY GOOD /
VERFÜGBARKEIT REICHLICH /
DISPONIBILITÉ BONNE

RETTIFICATO MONOCALIBRO
RECTIFIED SINGLE-CALIBRE / REKTIFIZIERT EINKALIBRIG /
RECTIFIÉ MONOCALIBRE

SPESSORE
THICKNESS / DICKE / ÉPAISSEUR

▼
10mm
▲

FORMATI
SIZES / FORMATE / FORMATS

120 x 60 cm
48" x 24"

60 x 60 cm
24" x 24"

60 x 30 cm
24" x 12"

60 x 15 cm
24" x 6"

SUPERFICI
SURFACES
OBERFLÄCHEN
SURFACES

COEFFICIENTE DI ATTRITO
FRICTION COEFFICIENT
REIBUNGSKOEFFIZIENT
COEFFICIENT DE FROTTEMENT

FORMATI / SIZES / FORMATE / FORMATS

PEZZI SPECIALI / TRIMS / FORMTEILE / PIÈCES SPÉCIALES

DECORI E MOSAICI / DECORS AND MOSAICS / DEKORE UND MOSAIKE / DECORS ET MOSAÏQUE

DI FABBRICA

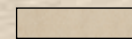
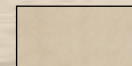

STRUTTURATO / STRUCTURED / STRUKTURIERT / STRUCTURÉ

SEMILUCIDATO / SEMI-POLISHED / SEMI-MATT / SEMI-LUSTRÉ

ST (R11) A+B+C

SL (R10) A

pag. 420

pag. 420/421

pag. 420

PIETRA DI BORGOGNA

PIETRE NATURALI HIGH-TECH

PROVENIENZA FRANCIA

ORIGIN FRANCE / HERKUNFT FRANKREICH /
PROVENANCE FRANCE

REPERIBILITÀ LIMITATA

AVAILABILITY SCARCE /
VERFÜGBARKEIT BEGRENZT /
DISPONIBILITÉ LIMITÉE

RETTIFICATO MONOCALIBRO

RECTIFIED SINGLE-CALIBRE / REKTIFIZIERT EINKALIBRIG /
RECTIFIÉ MONOCALIBRE

SPESSORE

THICKNESS / DICKE / ÉPAISSEUR

▼
10mm
▲

DI FABBRICA

FORMATI

SIZES / FORMATE / FORMATS

90 x 45 cm

36" x 17^{3/4}"



60 x 60 cm

24" x 24"



60 x 30 cm

24" x 12"

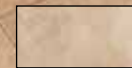

60 x 15 cm

24" x 6"

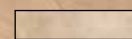

SUPERFICI

SURFACES
OBERFLÄCHEN
SURFACES

STRUTTURATO / STRUCTURED / STRUKTURIERT / STRUCTURÉ

SATINATO / SATIN-FINISH / SATINIERT / SATINÉ

COEFFICIENTE DI ATTRITO

FRICTION COEFFICIENT
REIBUNGSKOEFFIZIENT
COEFFICIENT DE FROTTEMENT

ST **(R11)** A+B+C

SA **(R10)** A+B+C

FORMATI / SIZES / FORMATE / FORMATS

PEZZI SPECIALI / TRIMS / FORMTEILE / PIÈCES SPÉCIALES

DECORI E MOSAICI / DECORS AND MOSAICS / DEKORE UND MOSAIKE / DECORS ET MOSAÏQUE

pag. 420

pag. 420/421

pag. 420



stone innovation

Il nome Silk Georgette e la finitura Bamboo sono repliche dell'originale in pietra naturale studiate e realizzate dalla Salvatori marmi e riprodotte su gentile concessione.

www.salvatori.it

The name Silk Georgette and finishing Bamboo are replicas of the original natural stone designed and manufactured by Salvatori marbles and reproduced by kind concession.

www.salvatori.it

SILK GEORGETTE

PIETRE NATURALI HIGH-TECH

PROVENIENZA MESSICO

ORIGIN MEXICO / HERKUNFT MEXIKO /
PROVENANCE MEXIQUE

REPERIBILITÀ MODESTA

AVAILABILITY SCARCE /
VERFÜGBARKEIT BESCHEIDEN /
DISPONIBILITÉ MODESTE

RETTIFICATO MONOCALIBRO

RECTIFIED SINGLE-CALIBRE / REKTIFIZIERT EINKALIBRIG /
RECTIFIÉ MONOCALIBRE

SPESSORE

THICKNESS / DICKE / ÉPAISSEUR

▼
10mm
▲

FORMATI

SIZES / FORMATE / FORMATS

120 x 60 cm
48" x 24"

120 x 30 cm
48" x 12"

60 x 60 cm
24" x 24"

60 x 30 cm
24" x 12"

DI FABBRICA



SUPERFICI

SURFACES
OBERFLÄCHEN
SURFACES

NATURALE / NATURAL / NATURBELASSEN / NATUREL

BAMBOO

COEFFICIENTE DI ATTRITO

FRICTION COEFFICIENT
REIBUNGSKOEFFIZIENT
COEFFICIENT DE FROTTEMENT

N (R9) A+B

BA (R12) A+B+C

FORMATI / SIZES / FORMATE / FORMATS

PEZZI SPECIALI / TRIMS / FORMTEILE / PIÈCES SPÉCIALES

DECORI E MOSAICI / DECORS AND MOSAICS / DEKORE UND MOSAIKE / DECORS ET MOSAÏQUE

pag. 420

pag. 420/421

pag. 420

BAMBOO

PIETRA PIASENTINA

PIETRE NATURALI HIGH-TECH

PROVENIENZA ITALIA
ORIGIN ITALY / HERKUNFT ITALIEN /
PROVENANCE ITALIE

REPERIBILITÀ BUONA
AVAILABILITY GOOD /
VERFÜGBARKEIT REICHLICH /
DISPONIBILITÉ BONNE

RETTIFICATO MONOCALIBRO
RECTIFIED SINGLE-CALIBRE / REKTIFIZIERT EINKALIBRIG /
RECTIFIÉ MONOCALIBRE

SPESSORE
THICKNESS / DICKE / ÉPAISSEUR

10mm

cm²

FORMATI
SIZES / FORMATE / FORMATS

120 x 60 cm
48" x 24"



60 x 60 cm
24" x 24"



60 x 30 cm
24" x 12"



60 x 15 cm
24" x 6"

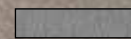

SUPERFICI
SURFACES
OBERFLÄCHEN
SURFACES

STRUTTURATO / STRUCTURED / STRUKTURIERT / STRUCTURÉ

SATINATO / SATIN-FINISH / SATINIERT / SATINÉ

COEFFICIENTE DI ATTRITO
FRICTION COEFFICIENT
REIBUNGSKOEFFIZIENT
COEFFICIENT DE FROTTEMENT

ST (R11) A+B

SA (R9)

FORMATI / SIZES / FORMATE / FORMATS
PEZZI SPECIALI / TRIMS / FORMTEILE / PIÈCES SPÉCIALES
DECORI E MOSAICI / DECORS AND MOSAICS / DEKORE UND MOSAIKE / DECORS ET MOSAÏQUE

pag. 420
pag. 420/421
pag. 420



Il nome Pietra d'Avola e la finitura Bamboo sono repliche dell'originale in pietra naturale studiate e realizzate dalla Salvatori marmi e riprodotte su gentile concessione.

www.salvatori.it

The name Pietra d'Avola and finishing Bamboo are replicas of the original natural stone designed and manufactured by Salvatori marbles and reproduced by kind concession.

www.salvatori.it

PIETRA D'AVOLA

PROVENIENZA ITALIA
ORIGIN ITALY / HERKUNFT ITALIEN /
PROVENANCE ITALIE

REPERIBILITÀ BUONA
AVAILABILITY GOOD /
VERFÜGBARKEIT REICHLICH /
DISPONIBILITÉ BONNE

RETTIFICATO MONOCALIBRO
RECTIFIED SINGLE-CALIBRE / REKTIFIZIERT EINKALIBRIG /
RECTIFIÉ MONOCALIBRE

SPESSORE
THICKNESS / DICKE / ÉPAISSEUR

10mm

FORMATI
SIZES / FORMATE / FORMATS

120 x 60 cm
48" x 24"

120 x 30 cm
48" x 12"

60 x 60 cm
24" x 24"

60 x 30 cm
24" x 12"

SUPERFICI
SURFACES
OBERFLÄCHEN
SURFACES

COEFFICIENTE DI ATTRITO
FRICTION COEFFICIENT
REIBUNGSKOEFFIZIENT
COEFFICIENT DE FROTTEMENT

FORMATI / SIZES / FORMATE / FORMATS
PEZZI SPECIALI / TRIMS / FORMTEILE / PIÈCES SPÉCIALES

DECORI E MOSAICI / DECORS AND MOSAICS / DEKORE UND MOSAIKE / DECORS ET MOSAÏQUE

PIETRE NATURALI HIGH-TECH

DI FABBRICA

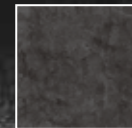

NATURALE / NATURAL / NATURBELASSEN / NATUREL
BAMBOO

N (R9) A

BA (R12) A+B+C

pag. 420
pag. 420/421
pag. 420

PIETRA DI RAGUSA

PIETRE NATURALI HIGH-TECH

PROVENIENZA ITALIA
ORIGIN ITALY / HERKUNFT ITALIEN /
PROVENANCE ITALIE

REPERIBILITÀ LIMITATA
AVAILABILITY SCARCE /
VERFÜGBARKEIT BEGRENZT /
DISPONIBILITÉ LIMITÉE

RETTIFICATO MONOCALIBRO
RECTIFIED SINGLE-CALIBRE / REKTIFIZIERT EINKALIBRIG /
RECTIFIÉ MONOCALIBRE

SPESSORE
THICKNESS / DICKE / ÉPAISSEUR

▼
10mm
▲

cm²

FORMATI
SIZES / FORMATE / FORMATS

90 x 45 cm
36" x 17^{3/4}"



60 x 60 cm
24" x 24"



60 x 30 cm
24" x 12"



60 x 15 cm
24" x 6"



SUPERFICI
SURFACES
OBERFLÄCHEN
SURFACES

STRUTTURATO / STRUCTURED / STRUKTURIERT / STRUCTURÉ

COEFFICIENTE DI ATTRITO
FRICTION COEFFICIENT
REIBUNGSKOEFFIZIENT
COEFFICIENT DE FROTTEMENT

ST **R11** A+B

FORMATI / SIZES / FORMATE / FORMATS
PEZZI SPECIALI / TRIMS / FORMTEILE / PIÈCES SPÉCIALES
DECORI E MOSAICI / DECORS AND MOSAICS / DEKORE UND MOSAIKE / DECORS ET MOSAÏQUE

pag. 420
pag. 420/421
pag. 420



PIETRA DI LUSERNA

PROVENIENZA ITALIA
ORIGIN ITALY / HERKUNFT ITALIEN /
PROVENANCE ITALIE

REPERIBILITÀ BUONA
AVAILABILITY GOOD /
VERFÜGBARKEIT REICHLICH /
DISPONIBILITÉ BONNE

RETTIFICATO MONOCALIBRO
RECTIFIED SINGLE-CALIBRE / REKTIFIZIERT EINKALIBRIG /
RECTIFIÉ MONOCALIBRE

SPESSORE
THICKNESS / DICKE / ÉPAISSEUR

10mm

FORMATI
SIZES / FORMATE / FORMATS

60 x 60 cm
24" x 24"

60 x 30 cm
24" x 12"

60 x 15 cm
24" x 6"

SUPERFICI
SURFACES
OBERFLÄCHEN
SURFACES

COEFFICIENTE DI ATTRITO
FRICTION COEFFICIENT
REIBUNGSKOEFFIZIENT
COEFFICIENT DE FROTTEMENT

FORMATI / SIZES / FORMATE / FORMATS
PEZZI SPECIALI / TRIMS / FORMTEILE / PIÈCES SPÉCIALES

DECORI E MOSAICI / DECORS AND MOSAICS / DEKORE UND MOSAIKE / DECORS ET MOSAÏQUE

PIETRE NATURALI HIGH-TECH

DI FABBRICA

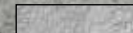

STRUTTURATO / STRUCTURED / STRUKTURIERT / STRUCTURÉ

SATINATO / SATIN-FINISH / SATINIERT / SATINÉ

ST (R11) A+B

SA (R9)

pag. 420

pag. 420/421

pag. 420

BASALTO GRIGIO

PIETRE NATURALI HIGH-TECH

PROVENIENZA ITALIA
ORIGIN ITALY / HERKUNFT ITALIEN /
PROVENANCE ITALIE

REPERIBILITÀ MODESTA
AVAILABILITY SCARCE /
VERFÜGBARKEIT BESCHIEDEN /
DISPONIBILITÉ MODESTE

RETTIFICATO MONOCALIBRO
RECTIFIED SINGLE-CALIBRE / REKTIFIZIERT EINKALIBRIG /
RECTIFIÉ MONOCALIBRE

SPESSORE
THICKNESS / DICKE / ÉPAISSEUR

10mm

cm²

FORMATI
SIZES / FORMATE / FORMATS

120 x 60 cm
48" x 24"

60 x 60 cm
24" x 24"

60 x 30 cm
24" x 12"

60 x 15 cm
24" x 6"

SUPERFICI
SURFACES
OBERFLÄCHEN
SURFACES

COEFFICIENTE DI ATTRITO
FRICTION COEFFICIENT
REIBUNGSKOEFFIZIENT
COEFFICIENT DE FROTTEMENT

FORMATI / SIZES / FORMATE / FORMATS

PEZZI SPECIALI / TRIMS / FORMTEILE / PIÈCES SPÉCIALES

DECORI E MOSAICI / DECORS AND MOSAICS / DEKORE UND MOSAIKE / DECORS ET MOSAÏQUE

DI FABBRICA

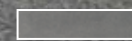
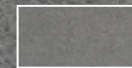
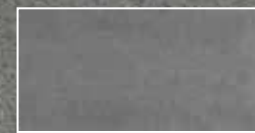

STRUTTURATO / STRUCTURED / STRUKTURIERT / STRUCTURÉ

SATINATO / SATIN-FINISH / SATINIERT / SATINÉ

ST (R11) A+B+C

SA (R10) A+B+C

pag. 420

pag. 420/421

pag. 420

ARDESIA ANTRACITE

PROVENIENZA INDIA
ORIGIN INDIA / HERKUNFT INDIEN /
PROVENANCE INDE

REPERIBILITÀ MODESTA
AVAILABILITY SCARCE /
VERFÜGBARKEIT BESCHIEDEN /
DISPONIBILITÉ MODESTE

RETTIFICATO MONOCALIBRO
RECTIFIED SINGLE-CALIBRE / REKTIFIZIERT EINKALIBRIG /
RECTIFIÉ MONOCALIBRE

SPESSORE
THICKNESS / DICKE / ÉPAISSEUR

10mm

FORMATI
SIZES / FORMATE / FORMATS

120 x 60 cm
48" x 24"

60 x 60 cm
24" x 24"

60 x 30 cm
24" x 12"

60 x 15 cm
24" x 6"

SUPERFICI
SURFACES
OBERFLÄCHEN
SURFACES

COEFFICIENTE DI ATTRITO
FRICTION COEFFICIENT
REIBUNGSKOEFFIZIENT
COEFFICIENT DE FROTTEMENT

FORMATI / SIZES / FORMATE / FORMATS
PEZZI SPECIALI / TRIMS / FORMTEILE / PIÈCES SPÉCIALES

DECORI E MOSAICI / DECORS AND MOSAICS / DEKORE UND MOSAIKE / DECORS ET MOSAÏQUE

GREENSTONE

DI FABBRICA

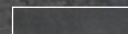
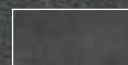

STRUTTURATO / STRUCTURED / STRUKTURIERT / STRUCTURÉ
SEMILUCIDATO / SEMI-POLISHED / SEMI-MATT / SEMI-LUSTRÉ

ST (R11) A+B+C

SL (R10) A

pag. 420
pag. 420/421
pag. 420

BLACK ARDESIA

PIETRE NATURALI HIGH-TECH

PROVENIENZA SPAGNA

ORIGIN SPAIN / HERKUNFT SPANIEN /
PROVENANCE ESPAGNE

REPERIBILITÀ BUONA

AVAILABILITY GOOD /
VERFÜGBARKEIT REICHLICH /
DISPONIBILITÉ BONNE

RETTIFICATO MONOCALIBRO

RECTIFIED SINGLE-CALIBRE / REKTIFIZIERT EINKALIBRIG /
RECTIFIÉ MONOCALIBRE

SPESSORE

THICKNESS / DICKE / ÉPAISSEUR

10mm

FORMATI

SIZES / FORMATE / FORMATS

120 x 60 cm
48" x 24"

90 x 45 cm
36" x 17^{3/4}"

60 x 60 cm
24" x 24"

60 x 30 cm
24" x 12"

60 x 15 cm
24" x 6"

SUPERFICI

SURFACES
OBERFLÄCHEN
SURFACES

COEFFICIENTE DI ATTRITO

FRICTION COEFFICIENT
REIBUNGSKOEFFIZIENT
COEFFICIENT DE FROTTEMENT

FORMATI / SIZES / FORMATE / FORMATS

PEZZI SPECIALI / TRIMS / FORMTEILE / PIÈCES SPÉCIALES

DECORI E MOSAICI / DECORS AND MOSAICS / DEKORE UND MOSAIKE / DECORS ET MOSAÏQUE

DI FABBRICA

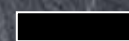
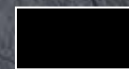
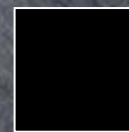
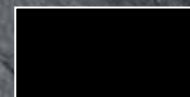
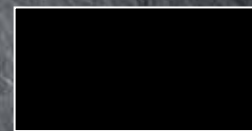

STRUTTURATO / STRUCTURED / STRUKTURIERT / STRUCTURÉ

SATINATO / SATIN-FINISH / SATINIERT / SATINÉ

ST (R10) A+B

SA (R10)

pag. 420

pag. 420/421

pag. 420

CADAPPA BLACK

GREENSTONE

PROVENIENZA INDIA

ORIGIN INDIA / HERKUNFT INDIEN /
PROVENANCE INDE

REPERIBILITÀ MODESTA

AVAILABILITY SCARCE /
VERFÜGBARKEIT BESCHEIDEN /
DISPONIBILITÉ MODESTE

RETTIFICATO MONOCALIBRO

RECTIFIED SINGLE-CALIBRE / REKTIFIZIERT EINKALIBRIG /
RECTIFIÉ MONOCALIBRE

SPESSORE

THICKNESS / DICKE / ÉPAISSEUR

10mm

FORMATI

SIZES / FORMATE / FORMATS

120 x 60 cm
48" x 24"

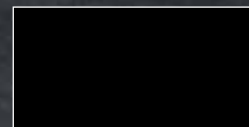

60 x 60 cm
24" x 24"

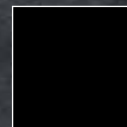

60 x 30 cm
24" x 12"

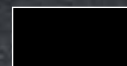

60 x 15 cm
24" x 6"



SUPERFICI

SURFACES
OBERFLÄCHEN
SURFACES

STRUTTURATO / STRUCTURED / STRUKTURIERT / STRUCTURÉ

SEMILUCIDATO / SEMI-POLISHED / SEMI-MATT / SEMI-LUSTRÉ

COEFFICIENTE DI ATTRITO

FRICTION COEFFICIENT
REIBUNGSKOEFFIZIENT
COEFFICIENT DE FROTTEMENT

ST (R11) A+B

SL (R10) A

FORMATI / SIZES / FORMATE / FORMATS

PEZZI SPECIALI / TRIMS / FORMTEILE / PIÈCES SPÉCIALES

DECORI E MOSAICI / DECORS AND MOSAICS / DEKORE UND MOSAIKE / DECORS ET MOSAÏQUE

pag. 420

pag. 420/421

pag. 420



THE IDEAL SOLUTION FOR OUTDOOR PAVING

CM2 è la soluzione ideale per la pavimentazione in esterno, con destinazione d'uso sia pubblico che privato. Facile da posare, estremamente agevole per l'ispezione di eventuali impianti e riposizionabile rapidamente in caso di variazioni di posa o di modificazioni del sottofondo.

CM2 possiede spessore e massa atti a garantire le prestazioni di resistenza meccanica e longevità richieste dalle diverse situazioni di rivestimento outdoor:

- + PAVIMENTAZIONE SOPRAELEVATA SU SUPPORTI REGOLABILI E FISSI
- + PAVIMENTAZIONE CARRABILE CON POSA TRADIZIONALE SU MASSETTO
- + POSA A SECCO SU GHIAIA, SABBIA ED ERBA

CM2 ist die ideale Lösung für die Bodenabdeckung im Außenbereich, und zwar sowohl für die private wie auch die öffentliche Benützung. Einfach zu verlegen, kann dieses Produkt im Falle von Revisionen allfälliger Installationen leicht bewegt und bei Veränderungen der Abdeckung oder des Untergrunds rasch verlegt werden.

CM2 verfügt über eine Stärke und Masse, die eine für die Außenabdeckung geeignete mechanische Widerstandsfähigkeit und Langlebigkeit garantieren:

- + BODENBELÄGE, DIE AUF EINSTELLBAREN ODER FIXEN STÜTZEN VERLEGT WERDEN
- + BEFAHRBARE BODENBELÄGE, DIE AUF EINER TRADITIONELLEN ZEMENTUNTERLAGE ANGEBRACHT WERDEN
- + TROCKENVERLEGUNG AUF KIES, SAND ODER GRAS

CM2 is the ideal solution for outdoor paving, designed for both public and private use.

Easy to install, very easy to inspect any utilities, and easy to reposition in the event of changes to the installation or modifications to the substrate.

CM2 has dimensions and mass such as to guarantee the mechanical resistance and longevity demanded by the diverse requirements of outdoor paving:

- + RAISED PAVING ON ADJUSTABLE OR FIXED SUPPORTS
- + DRIVEWAY PAVING WITH TRADITIONAL INSTALLATION ON SCREED
- + DRY INSTALLATION ON GRAVEL, SAND OR GRASS

CM2 est la solution idéale pour les sols extérieurs, à usage public et privé. Facile à installer, extrêmement maniable pour l'inspection d'éventuelles installations, les dalles peuvent être repositionnées rapidement en cas de variations de pose ou de modifications du support.

La masse et l'épaisseur de CM2 peuvent assurer les prestations de résistance mécanique et de longévité que les différentes situations revêtement demandent:

- + SOL SURÉLEVÉ SUR SUPPORT RÉGLABLES ET FIXES
- + SOL CARROSSABLE AVEC UNE POSE TRADITIONNELLE SUR CHAPE DE CIMENT
- + POSE À SEC SUR GRAVIER, SABLE ET HERBE

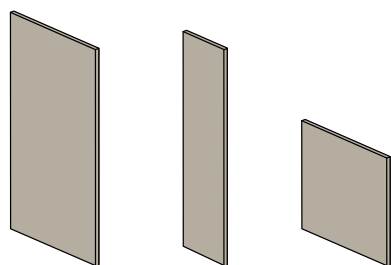

120 x 60
48" x 24"

120 x 30
48" x 12"

60 x 60
24" x 24"

FORMATI /
SIZES / FORMATE / FORMATS

GRADONE BECCO CM2
STEPTREAD WITH HALF
BULLNOSE EDGE CM2/
STUFENPLATTE MIT
ABGERUNDETER KANTE CM2/
NEZ DE MARCHE AVEC BORD
ARRONDI CM2

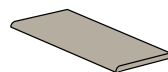

60 x 30
24" x 12"

GRADONE TORO CM2 /
STEPTREAD GRADONE TORO CM2 /
STUFENPLATTE TORO CM2 /
NEZ DE MARCHE ÉPAISSEUR CM2

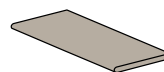

60 x 30
24" x 12"

GRIGLIA CM2
WATER GRATE /
ABDECKPLATTE WASSERABLAUF /
GRILLE

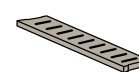

60 x 15
24" x 6"

PEZZI SPECIALI /
TRIMS / FORMTEILE / PIÈCES SPÉCIALES



APPLICAZIONI DEL CM2

APPLICATIONS OF CM2

ANWENDUNGEN VON CM2

LES APPLICATIONS DE CM2

- + **PAVIMENTAZIONE SOPRAELEVATA SU SUPPORTI REGOLABILI E FISSI**
- + RAISED PAVING ON ADJUSTABLE OR FIXED SUPPORTS
- + BODENABDECKUNGEN AUF EINSTELLBAREN ODER FIXEN STÜTZEN
- + SOL SURÉLEVÉ SUR SUPPORT RÉGLABLES ET FIXES

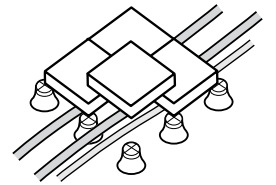

- + **POSA A SECCO SU GHIAIA**
- + DRY INSTALLATION ON GRAVEL
- + TROCKENVERLEGUNG AUF KIES
- + POSE À SEC SUR GRAVIER

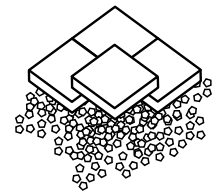

- + **PAVIMENTAZIONE CARRABILE CON POSA TRADIZIONALE SU MASSETTO**
- + DRIVEWAY PAVING ON TRADITIONAL SCREED
- + BEFAHRBARE BODENABDECKUNG, DIE AUF EINER TRADITIONELLEN ZEMENTUNTERLAGE ANGEBRACHT WIRD
- + SOL CARROSSABLE AVEC UNE INSTALLATION TRADITIONNELLE SUR CHAPE

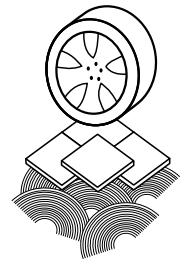

- + **POSA A SECCO SU SABBIA**
- + DRY INSTALLATION ON SAND
- + TROCKENVERLEGUNG AUF SAND
- + POSE À SEC SUR SABLE

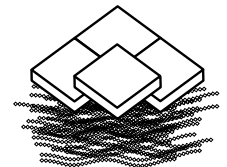

- + **POSA A SECCO SU ERBA**
- + DRY INSTALLATION ON GRASS
- + TROCKENVERLEGUNG AUF GRAS
- + POSE À SEC SUR HERBE

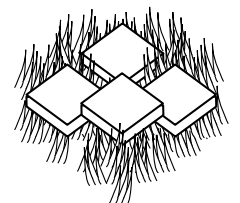

VANTAGGI DEL CM2

ADVANTAGES OF CM2

VORTEILE VON CM2

LES AVANTAGES DE CM2

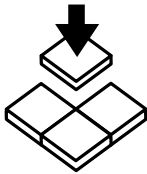

- + Facile da posare anche senza collanti e stucchi;
- + Easy to install even without adhesives or filler;
- + Einfach zu verlegen, auch ohne Klebstoffe oder Mörtel;
- + Facile à installer sans colles ni joints.

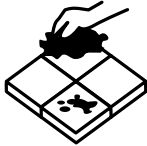

- + Facile da pulire perché non si utilizzano collanti e stucchi;
- + Easy to clean due to the lack of adhesives and filler;
- + Einfach zu reinigen, da keine Klebstoffe oder Mörtel verwendet werden;
- + Facile à nettoyer parce que vous n'utilisez ni colles ni joints.

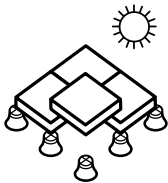

- + Ideale per pavimentazioni in esterno, anche sopraelevate;
- + Ideal for paving outdoor installations, including raised paving;
- + Ideal für Aussenabdeckungen, auch für überlagerte Konstruktionen;
- + Idéal pour les pavages extérieurs, même surélevés.

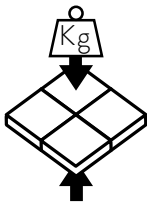

- + Resistente ai carichi di rottura;
- + High tensile strength;
- + Widerstandsfähig gegen Reißfestigkeit;
- + Résistant aux charges de rupture.

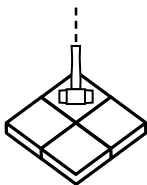

- + Resistente alle sollecitazioni;
- + Stress-resistant;
- + Widerstandsfähig gegen Beanspruchung;
- + Résistant aux sollicitations.



- + Drenante, facilita il deflusso delle acque di meteoriche ed evita ristagni potenzialmente dannosi;
- + Good drainage, facilitates the flow of water and rainfall, eliminating harmful stagnation;
- + Sezernierend, erleichtert den Abfluss bei Niederschlag und verhindert potentiell schädlichen Rückstau;
- + Drainant, il facilite la circulation des eaux de pluie et évite des stagnations potentiellement dangereuses;



- + Antiscivolo (R11 - A+B)
- + Antislip (R11 - A+B)
- + Rutschfest (R11 - A+B)
- + Antidérapant (R11 - A+B)

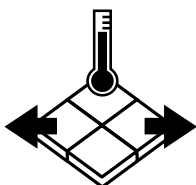

- + Resistente alla dilatazione termica;
- + Highly resistant to changes in temperature;
- + Sehr widerstandsfähig gegen Wärmeausdehnung;
- + Résiste à la dilatation thermique.

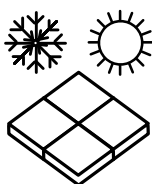

- + Resistente agli agenti atmosferici;
- + Weather resistant;
- + Widerstandsfähig gegen Klimaeinflüsse;
- + Résistant aux agents atmosphériques.

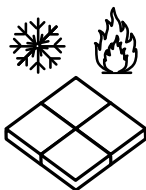

- + Antigelivo ed ignifugo;
- + Frost and fire-resistant;
- + Frost- und feuersicher;
- + Résistant au gel et ignifugé.

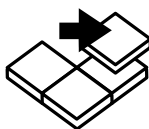

- + Removibile e riutilizzabile;
- + Removable and reusable;
- + Auswechselbar und wiederverwendbar;
- + Amovible et réutilisable.

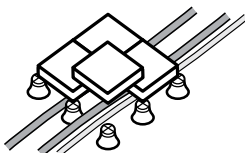

- + Ispezionabile e funzionale, favorisce il passaggio e la manutenzione di impianti di cablaggi e tubazioni;
- + Easily inspected and functional, allows installation and maintenance of cabling and pipework;
- + Überprüfbar und funktionell; ermöglicht die Verlegung und den Unterhalt von Kabelleitungen und Rohrleitungen;
- + Grâce à une inspection facile et fonctionnelle, les dalles favorisent le passage et le maintien des installations de câbles et de tuyaux.



CLOUD

CON.CREA.



RETTIFICATO MONOCALIBRO

RECTIFIED SINGLE-CALIBRE / REKTIFIZIERT EINKALIBRIG /
RECTIFIÉ MONOCALIBRE

SPESSORE

THICKNESS / DICKE / ÉPAISSEUR

A diagram showing a horizontal line with a downward-pointing triangle at the top and an upward-pointing triangle at the bottom. The text '20mm' is centered between the two triangles.

FORMATI

SIZES / FORMATE / FORMATS

120 x 60 cm
48" x 24"

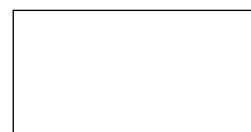

60 x 60 cm
24" x 24"

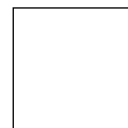

EARTH

SUPERFICI / SURFACES / OBERFLÄCHEN / SURFACES

ANTISLIP

INK

COEFFICIENTE DI ATTRITO

FRICITION COEFFICIENT
REIBUNGSKOEFFIZIENT
COEFFICIENT DE FROTTEMENT

AS 

FORMATI pag. 422

SIZES pag. 422 / FORMATE pag. 422 / FORMATS pag. 422

PEZZI SPECIALI pag. 422

TRIMS pag. 422 / FORMTEILE pag. 422 / PIÈCES SPÉCIALES pag. 422

TALC

CON.CREA.



RETTIFICATO MONOCALIBRO

RECTIFIED SINGLE-CALIBRE / REKTIFIZIERT EINKALIBRIG /
RECTIFIÉ MONOCALIBRE

SPESSORE

THICKNESS / DICKE / ÉPAISSEUR

$\frac{20\text{mm}}$

FORMATI

SIZES / FORMATE / FORMATS

120 x 60 cm
48" x 24"

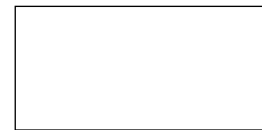

60 x 60 cm
24" x 24"

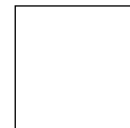

DOVE GREY

SUPERFICI / SURFACES / OBERFLÄCHEN / SURFACES

ANTISLIP

COEFFICIENTE DI ATTRITO

FRICITION COEFFICIENT
REIBUNGSKOEFFIZIENT
COEFFICIENT DE FROTTEMENT

AS **(R11)**

FORMATI pag. 422

SIZES pag. 422 / FORMATE pag. 422 / FORMATS pag. 422

PEZZI SPECIALI pag. 422

TRIMS pag. 422 / FORMTEILE pag. 422 / PIÈCES SPÉCIALES pag. 422



CREMA EUROPA

PIETRE NATURALI HIGH-TECH



RETTIFICATO MONOCALIBRO

RECTIFIED SINGLE-CALIBRE / REKTIFIZIERT EINKALIBRIG /
RECTIFIÉ MONOCALIBRE

SPESSORE

THICKNESS / DICKE / ÉPAISSEUR

20mm

FORMATI

SIZES / FORMATE / FORMATS

60 x 60 cm

24"x 24"

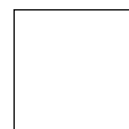

PIETRA PIASENTINA

SUPERFICI / SURFACES / OBERFLÄCHEN / SURFACES

STRUTTURATO / STRUCTURED / STRUKTURIERT / STRUCTURÉ

COEFFICIENTE DI ATTRITO

FRICTION COEFFICIENT
REIBUNGSKOEFFIZIENT
COEFFICIENT DE FROTTEMENT

ST (R11) A+B

FORMATI pag. 422

SIZES pag. 422 / FORMATE pag. 422 / FORMATS pag. 422

PEZZI SPECIALI pag. 422

TRIMS pag. 422 / FORMTEILE pag. 422 / PIÈCES SPÉCIALES pag. 422

PIETRA DI RAGUSA

PIETRE NATURALI
HIGH-TECH



RETTIFICATO MONOCALIBRO

RECTIFIED SINGLE-CALIBRE / REKTIFIZIERT EINKALIBRIG /
RECTIFIÉ MONOCALIBRE

SPESSORE

THICKNESS / DICKE / ÉPAISSEUR

20mm

FORMATI

SIZES / FORMATE / FORMATS

120 x 60 cm
48" x 24"

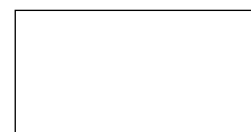

ABSOLUTE BLACK

60 x 60 cm
24" x 24"

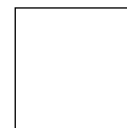

BASALTO GRIGIO

ABSOLUTE BLACK

SUPERFICI / SURFACES / OBERFLÄCHEN / SURFACES

STRUTTURATO / STRUCTURED / STRUKTURIERT / STRUCTURÉ

COEFFICIENTE DI ATTRITO

FRICTION COEFFICIENT
REIBUNGSKOEFFIZIENT
COEFFICIENT DE FROTTEMENT

ST (R11) A+B

FORMATI pag. 422

SIZES pag. 422 / FORMATE pag. 422 / FORMATS pag. 422

PEZZI SPECIALI pag. 422

TRIMS pag. 422 / FORMTEILE pag. 422 / PIÈCES SPÉCIALES pag. 422

DIORITE

MATERIE
HIGH-TECH



RETTIFICATO MONOCALIBRO

RECTIFIED SINGLE-CALIBRE / REKTIFIZIERT EINKALIBRIG /
RECTIFIÉ MONOCALIBRE

SPESSORE

THICKNESS / DICKE / ÉPAISSEUR

A diagram showing a horizontal line with a downward-pointing triangle above it and an upward-pointing triangle below it. The text '20mm' is centered between the two triangles.
20mm

CENERE

FORMATI

SIZES / FORMATE / FORMATS

120 x 60 cm
48" x 24"



60 x 60 cm
24" x 24"

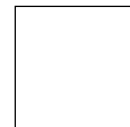

FANGO

SUPERFICI / SURFACES / OBERFLÄCHEN / SURFACES

ANTISLIP

COEFFICIENTE DI ATTRITO

FRICITION COEFFICIENT
REIBUNGSKOEFFIZIENT
COEFFICIENT DE FROTTEMENT

AS A+B

PELTRO

FORMATI pag. 422

SIZES pag. 422 / FORMATE pag. 422 / FORMATS pag. 422

PEZZI SPECIALI pag. 422

TRIMS pag. 422 / FORMTEILE pag. 422 / PIÈCES SPÉCIALES pag. 422



LIGHT GREY

TEKNOSTONE



RETTIFICATO MONOCALIBRO

RECTIFIED SINGLE-CALIBRE / REKTIFIZIERT EINKALIBRIG /
RECTIFIÉ MONOCALIBRE

SPESSORE

THICKNESS / DICKE / ÉPAISSEUR

20mm

FORMATI

SIZES / FORMATE / FORMATS

120 x 60 cm

48" x 24"



60 x 60 cm

24" x 24"

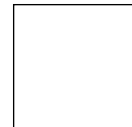

SMOKE

SUPERFICI / SURFACES / OBERFLÄCHEN / SURFACES

ANTISLIP

SOFT BLACK

COEFFICIENTE DI ATTRITO

FRICTION COEFFICIENT

REIBUNGSKOEFFIZIENT

COEFFICIENT DE FROTTEMENT

AS (R11) A+B

FORMATI pag. 422

SIZES pag. 422 / FORMATE pag. 422 / FORMATS pag. 422

PEZZI SPECIALI pag. 422

TRIMS pag. 422 / FORMTEILE pag. 422 / PIÈCES SPÉCIALES pag. 422



ROVERE SABBIA

LEGNI HIGH-TECH 



RETTIFICATO MONOCALIBRO

RECTIFIED SINGLE-CALIBRE / REKTIFIZIERT EINKALIBRIG /
RECTIFIÉ MONOCALIBRE

SPESSORE

THICKNESS / DICKE / ÉPAISSEUR

20mm

FORMATI

SIZES / FORMATE / FORMATS

120 x 60 cm
48"x 24"

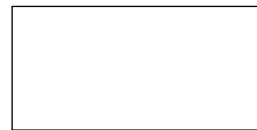

120 x 30 cm
48"x 12"

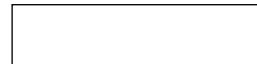

ROVERE BRICCOLA

SUPERFICI / SURFACES / OBERFLÄCHEN / SURFACES

ANTICATO / ANTIQUED / ANTIK / ANTIQUE

ROVERE IMPERO

COEFFICIENTE DI ATTRITO

FRICITION COEFFICIENT
REIBUNGSKOEFFIZIENT
COEFFICIENT DE FROTTEMENT

AN  A+B

FORMATI pag. 422

SIZES pag. 422 / FORMATE pag. 422 / FORMATS pag. 422

PEZZI SPECIALI pag. 422

TRIMS pag. 422 / FORMTEILE pag. 422 / PIÈCES SPÉCIALES pag. 422



ROVERE CENERE

LEGNI HIGH-TECH 



RETTIFICATO MONOCALIBRO

RECTIFIED SINGLE-CALIBRE / REKTIFIZIERT EINKALIBRIG /
RECTIFIÉ MONOCALIBRE

SPESSORE

THICKNESS / DICKE / ÉPAISSEUR

20mm

FORMATI

SIZES / FORMATE / FORMATS

120 x 60 cm
48"x 24"



120 x 30 cm
48"x 12"



ROVERE GRIGIO

SUPERFICI / SURFACES / OBERFLÄCHEN / SURFACES

ANTICATO / ANTIQUED / ANTIK / ANTIQUE

ROVERE TUNDRA

COEFFICIENTE DI ATTRITO

FRICITION COEFFICIENT
REIBUNGSKOEFFIZIENT
COEFFICIENT DE FROTTEMENT

AN  A+B

FORMATI pag. 422

SIZES pag. 422 / FORMATE pag. 422 / FORMATS pag. 422

PEZZI SPECIALI pag. 422

TRIMS pag. 422 / FORMTEILE pag. 422 / PIÈCES SPÉCIALES pag. 422

QUERCIA SHABBY	338
QUERCIA CANADESE	340
QUERCIA BIANCA	342
QUERCIA TROPICALE	344
QUERCIA PETRAEA	346
ROVERE TUNDRA	348
ROVERE PROVENZALE	350
ROVERE CENERE	352
ROVERE SABBIA	354
ROVERE CORDA	356
ROVERE DECAPÉ	358
ROVERE BRICCOLA	360
ROVERE NOCE	362
ROVERE IMPERO	364
ROVERE REALE	366
ROVERE MOKA	368
ROVERE GRIGIO	370
ROVERE BIANCO	372
ROVERE NATURALE	374
ROVERE CILIEGIO	376
ROVERE ANTICO	378
ROVERE ABBAZIA	380
ROVERE NERO	382
WOODRAW ARTIC	384
WOODRAW ASH	386
WOODRAW BOARD	388
WOODRAW POWDER	390
WOODRAW RUST	392



LEGNI HIGH-TECH

LEGNI INNOVATIVE SLABS, HIGH-TECH & WOODRAW



QUERCIA SHABBY

INNOVATIVE SLABS
LEGNI HIGH-TECH



RETTIFICATO MONOCALIBRO
RECTIFIED SINGLE-CALIBRE / REKTIFIZIERT EINKALIBRIG /
RECTIFIÉ MONOCALIBRE

SPESSORE
THICKNESS / DICKE / ÉPAISSEUR

▼
6mm
▲

FORMATI
SIZES / FORMATE / FORMATS

150 x 37,5 cm
60" x 15"



150 x 25 cm
60" x 10"



150x18,7 cm
60" x 8"



SUPERFICI
SURFACES
OBERFLÄCHEN
SURFACES

ANTICATO / ANTIQUED / ANTIK / ANTIQUE

COEFFICIENTE DI ATTRITO
FRICTION COEFFICIENT
REIBUNGSKOEFFIZIENT
COEFFICIENT DE FROTTEMENT

AN (R10) A+B

FORMATI / SIZES / FORMATE / FORMATS
PEZZI SPECIALI / TRIMS / FORMTEILE / PIÈCES SPÉCIALES

pag. 422
pag. 422



QUERCIA CANADESE

INNOVATIVE SLABS
LEGNI HIGH-TECH



RETTIFICATO MONOCALIBRO

RECTIFIED SINGLE-CALIBRE / REKTIFIZIERT EINKALIBRIG /
RECTIFIÉ MONOCALIBRE

SPESSORE

THICKNESS / DICKE / ÉPAISSEUR

6mm

FORMATI

SIZES / FORMATE / FORMATS

150 x 37,5 cm
60" x 15"

150 x 25 cm
60" x 10"

150x18,7 cm
60" x 8"

SUPERFICI

SURFACES
OBERFLÄCHEN
SURFACES

COEFFICIENTE DI ATTRITO

FRICITION COEFFICIENT
REIBUNGSKOEFFIZIENT
COEFFICIENT DE FROTTEMENT

FORMATI / SIZES / FORMATE / FORMATS
PEZZI SPECIALI / TRIMS / FORMTEILE / PIÈCES SPÉCIALES

ANTICATO / ANTIQUED / ANTIK / ANTIQUE

AN (R10) A+B

pag. 422
pag. 422



QUERCIA BIANCA

INNOVATIVE SLABS
LEGNI HIGH-TECH 

RETTIFICATO MONOCALIBRO
RECTIFIED SINGLE-CALIBRE / REKTIFIZIERT EINKALIBRIG /
RECTIFIÉ MONOCALIBRE

SPESORE
THICKNESS / DICKE / ÉPAISSEUR

▼
6mm
▲

FORMATI
SIZES / FORMATE / FORMATS

150 x 37,5 cm
60" x 15"

150 x 25 cm
60" x 10"

150x18,7 cm
60" x 8"

SUPERFICI
SURFACES
OBERFLÄCHEN
SURFACES

COEFFICIENTE DI ATTRITO
FRICTION COEFFICIENT
REIBUNGSKOEFFIZIENT
COEFFICIENT DE FROTTEMENT

FORMATI / SIZES / FORMATE / FORMATS
PEZZI SPECIALI / TRIMS / FORMTEILE / PIÈCES SPÉCIALES

ANTICATO / ANTIQUED / ANTIK / ANTIQUE

AN (R10) A+B

pag. 422
pag. 422



QUERCIA TROPICALE

INNOVATIVE SLABS
LEGGI HIGH-TECH 

RETTIFICATO MONOCALIBRO
RECTIFIED SINGLE-CALIBRE / REKTIFIZIERT EINKALIBRIG /
RECTIFIÉ MONOCALIBRE

SPESSORE
THICKNESS / DICKE / ÉPAISSEUR

6mm

FORMATI
SIZES / FORMATE / FORMATS

150 x 37,5 cm
60" x 15"

150 x 25 cm
60" x 10"

150x18,7 cm
60" x 8"

SUPERFICI
SURFACES
OBERFLÄCHEN
SURFACES

COEFFICIENTE DI ATTRITO
FRICTION COEFFICIENT
REIBUNGSKOEFFIZIENT
COEFFICIENT DE FROTTEMENT

FORMATI / SIZES / FORMATE / FORMATS
PEZZI SPECIALI / TRIMS / FORMTEILE / PIÈCES SPÉCIALES

ANTICATO / ANTIQUED / ANTIK / ANTIQUE

AN (R10) A+B

pag. 422
pag. 422



QUERCIA PETRAEA

INNOVATIVE SLABS
LEGGI HIGH-TECH 

RETTIFICATO MONOCALIBRO
RECTIFIED SINGLE-CALIBRE / REKTIFIZIERT EINKALIBRIG /
RECTIFIÉ MONOCALIBRE

SPESSORE
THICKNESS / DICKE / ÉPAISSEUR

6mm

FORMATI
SIZES / FORMATE / FORMATS

150 x 37,5 cm
60" x 15"

150 x 25 cm
60" x 10"

150x18,7 cm
60" x 8"

SUPERFICI
SURFACES
OBERFLÄCHEN
SURFACES

COEFFICIENTE DI ATTRITO
FRICTION COEFFICIENT
REIBUNGSKOEFFIZIENT
COEFFICIENT DE FROTTEMENT

FORMATI / SIZES / FORMATE / FORMATS
PEZZI SPECIALI / TRIMS / FORMTEILE / PIÈCES SPÉCIALES

ANTICATO / ANTIQUED / ANTIK / ANTIQUE

AN  A+B

pag. 422
pag. 422

ROVERE TUNDRA

LEGNI HIGH-TECH 

RETTIFICATO MONOCALIBRO
RECTIFIED SINGLE-CALIBRE / REKTIFIZIERT EINKALIBRIG /
RECTIFIÉ MONOCALIBRE

SPESSORE
THICKNESS / DICKE / ÉPAISSEUR

10mm
cm²

FORMATI
SIZES / FORMATE / FORMATS

120 x 30 cm
48" x 12"

120 x 20 cm
48" x 8"

120x15 cm
48" x 6"

SUPERFICI
SURFACES
OBERFLÄCHEN
SURFACES

COEFFICIENTE DI ATTRITO
FRICTION COEFFICIENT
REIBUNGSKOEFFIZIENT
COEFFICIENT DE FROTTEMENT

FORMATI / SIZES / FORMATE / FORMATS
PEZZI SPECIALI / TRIMS / FORMTEILE / PIÈCES SPÉCIALES

ANTICATO / ANTIQUED / ANTIK / ANTIQUE

AN (R10) A

pag. 423
pag. 423



ROVERE PROVENZALE

LEGNI HIGH-TECH 

RETTIFICATO MONOCALIBRO
RECTIFIED SINGLE-CALIBRE / REKTIFIZIERT EINKALIBRIG /
RECTIFIÉ MONOCALIBRE

SPESSORE
THICKNESS / DICKE / ÉPAISSEUR

▼
10mm
▲

120 x 30 cm
48" x 12"

120 x 20 cm
48" x 8"

120x15 cm
48" x 6"

SUPERFICI
SURFACES
OBERFLÄCHEN
SURFACES

COEFFICIENTE DI ATTRITO
FRICTION COEFFICIENT
REIBUNGSKOEFFIZIENT
COEFFICIENT DE FROTTEMENT

FORMATI / SIZES / FORMATE / FORMATS
PEZZI SPECIALI / TRIMS / FORMTEILE / PIÈCES SPÉCIALES

ANTICATO / ANTIQUED / ANTIK / ANTIQUE

AN (R10) A+B

pag. 423
pag. 423



ROVERE CENERE

LEGNI HIGH-TECH 

RETTIFICATO MONOCALIBRO
RECTIFIED SINGLE-CALIBRE / REKTIFIZIERT EINKALIBRIG /
RECTIFIÉ MONOCALIBRE

SPESSORE
THICKNESS / DICKE / ÉPAISSEUR

▼
10mm
▲
cm2

FORMATI
SIZES / FORMATE / FORMATS

120 x 30 cm
48" x 12"



120 x 20 cm
48" x 8"



120x15 cm
48" x 6"



SUPERFICI
SURFACES
OBERFLÄCHEN
SURFACES

ANTICATO / ANTIQUED / ANTIK / ANTIQUE

COEFFICIENTE DI ATTRITO
FRICTION COEFFICIENT
REIBUNGSKOEFFIZIENT
COEFFICIENT DE FROTTEMENT

AN **(R10)** A+B

FORMATI / SIZES / FORMATE / FORMATS
PEZZI SPECIALI / TRIMS / FORMTEILE / PIÈCES SPÉCIALES

pag. 423
pag. 423



RETTIFICATO MONOCALIBRO
RECTIFIED SINGLE-CALIBRE / REKTIFIZIERT EINKALIBRIG /
RECTIFIÉ MONOCALIBRE

SPESSORE
THICKNESS / DICKE / ÉPAISSEUR

▼
10mm
▲

◄
cm²
►

FORMATI
SIZES / FORMATE / FORMATS

120 x 30 cm
48" x 12"



120 x 20 cm
48" x 8"

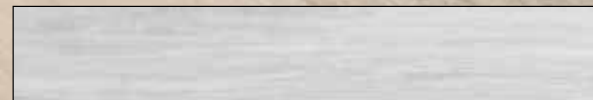

120x15 cm
48" x 6"

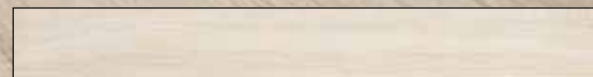

SUPERFICI
SURFACES
OBERFLÄCHEN
SURFACES

ANTICATO / ANTIQUED / ANTIK / ANTIQUE

COEFFICIENTE DI ATTRITO
FRICTION COEFFICIENT
REIBUNGSKOEFFIZIENT
COEFFICIENT DE FROTTEMENT

AN **(R9)** A

FORMATI / SIZES / FORMATE / FORMATS
PEZZI SPECIALI / TRIMS / FORMTEILE / PIÈCES SPÉCIALES

pag. 423
pag. 423



RETTIFICATO MONOCALIBRO
RECTIFIED SINGLE-CALIBRE / REKTIFIZIERT EINKALIBRIG /
RECTIFIÉ MONOCALIBRE

SPESSORE
THICKNESS / DICKE / ÉPAISSEUR

▼
10mm
▲

FORMATI
SIZES / FORMATE / FORMATS

120 x 30 cm
48" x 12"



120 x 20 cm
48" x 8"



120x15 cm
48" x 6"



SUPERFICI
SURFACES
OBERFLÄCHEN
SURFACES

ANTICATO / ANTIQUED / ANTIK / ANTIQUE

COEFFICIENTE DI ATTRITO
FRICTION COEFFICIENT
REIBUNGSKOEFFIZIENT
COEFFICIENT DE FROTTEMENT

AN **(R10)** A

FORMATI / SIZES / FORMATE / FORMATS
PEZZI SPECIALI / TRIMS / FORMTEILE / PIÈCES SPÉCIALES

pag. 423
pag. 423



ROVERE DECAPÉ

LEGNI HIGH-TECH 

RETTIFICATO MONOCALIBRO
RECTIFIED SINGLE-CALIBRE / REKTIFIZIERT EINKALIBRIG /
RECTIFIÉ MONOCALIBRE

SPESSORE
THICKNESS / DICKE / ÉPAISSEUR

▼
10mm
▲

FORMATI
SIZES / FORMATE / FORMATS

120 x 30 cm
48" x 12"



120 x 20 cm
48" x 8"

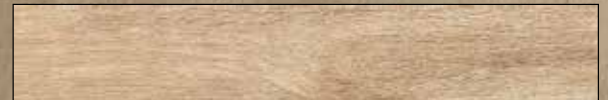

120x15 cm
48" x 6"



SUPERFICI
SURFACES
OBERFLÄCHEN
SURFACES

ANTICATO / ANTIQUED / ANTIK / ANTIQUE

COEFFICIENTE DI ATTRITO
FRICTION COEFFICIENT
REIBUNGSKOEFFIZIENT
COEFFICIENT DE FROTTEMENT

AN (R10) A

FORMATI / SIZES / FORMATE / FORMATS
PEZZI SPECIALI / TRIMS / FORMTEILE / PIÈCES SPÉCIALES

pag. 423
pag. 423



RETTIFICATO MONOCALIBRO
RECTIFIED SINGLE-CALIBRE / REKTIFIZIERT EINKALIBRIG /
RECTIFIÉ MONOCALIBRE

SPESSORE
THICKNESS / DICKE / ÉPAISSEUR

▼
10mm
▲
cm2

FORMATI
SIZES / FORMATE / FORMATS

120 x 30 cm
48" x 12"

120 x 20 cm
48" x 8"

120x15 cm
48" x 6"

SUPERFICI
SURFACES
OBERFLÄCHEN
SURFACES

ANTICATO / ANTIQUED / ANTIK / ANTIQUE

COEFFICIENTE DI ATTRITO
FRICTION COEFFICIENT
REIBUNGSKOEFFIZIENT
COEFFICIENT DE FROTTEMENT

AN **(R11)** A+B

FORMATI / SIZES / FORMATE / FORMATS
PEZZI SPECIALI / TRIMS / FORMTEILE / PIÈCES SPÉCIALES

pag. 423
pag. 423



RETTIFICATO MONOCALIBRO
RECTIFIED SINGLE-CALIBRE / REKTIFIZIERT EINKALIBRIG /
RECTIFIÉ MONOCALIBRE

SPESSORE
THICKNESS / DICKE / ÉPAISSEUR

▼
10mm
▲

FORMATI
SIZES / FORMATE / FORMATS

120 x 30 cm
48" x 12"

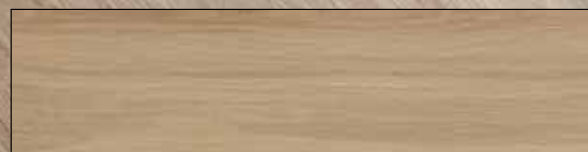

120 x 20 cm
48" x 8"



120x15 cm
48" x 6"

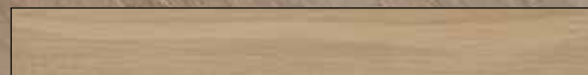

SUPERFICI
SURFACES
OBERFLÄCHEN
SURFACES

ANTICATO / ANTIQUED / ANTIK / ANTIQUE

COEFFICIENTE DI ATTRITO
FRICTION COEFFICIENT
REIBUNGSKOEFFIZIENT
COEFFICIENT DE FROTTEMENT

AN **(R10)** A+B

FORMATI / SIZES / FORMATE / FORMATS
PEZZI SPECIALI / TRIMS / FORMTEILE / PIÈCES SPÉCIALES

pag. 423
pag. 423



RETTIFICATO MONOCALIBRO
RECTIFIED SINGLE-CALIBRE / REKTIFIZIERT EINKALIBRIG /
RECTIFIÉ MONOCALIBRE

SPESSORE
THICKNESS / DICKE / ÉPAISSEUR

10mm
cm²

FORMATI
SIZES / FORMATE / FORMATS

120 x 30 cm
48" x 12"

120 x 20 cm
48" x 8"

120x15 cm
48" x 6"

SUPERFICI
SURFACES
OBERFLÄCHEN
SURFACES

COEFFICIENTE DI ATTRITO
FRICTION COEFFICIENT
REIBUNGSKOEFFIZIENT
COEFFICIENT DE FROTTEMENT

FORMATI / SIZES / FORMATE / FORMATS
PEZZI SPECIALI / TRIMS / FORMTEILE / PIÈCES SPÉCIALES

ANTICATO / ANTIQUED / ANTIK / ANTIQUE

AN (R10) A

pag. 423
pag. 423

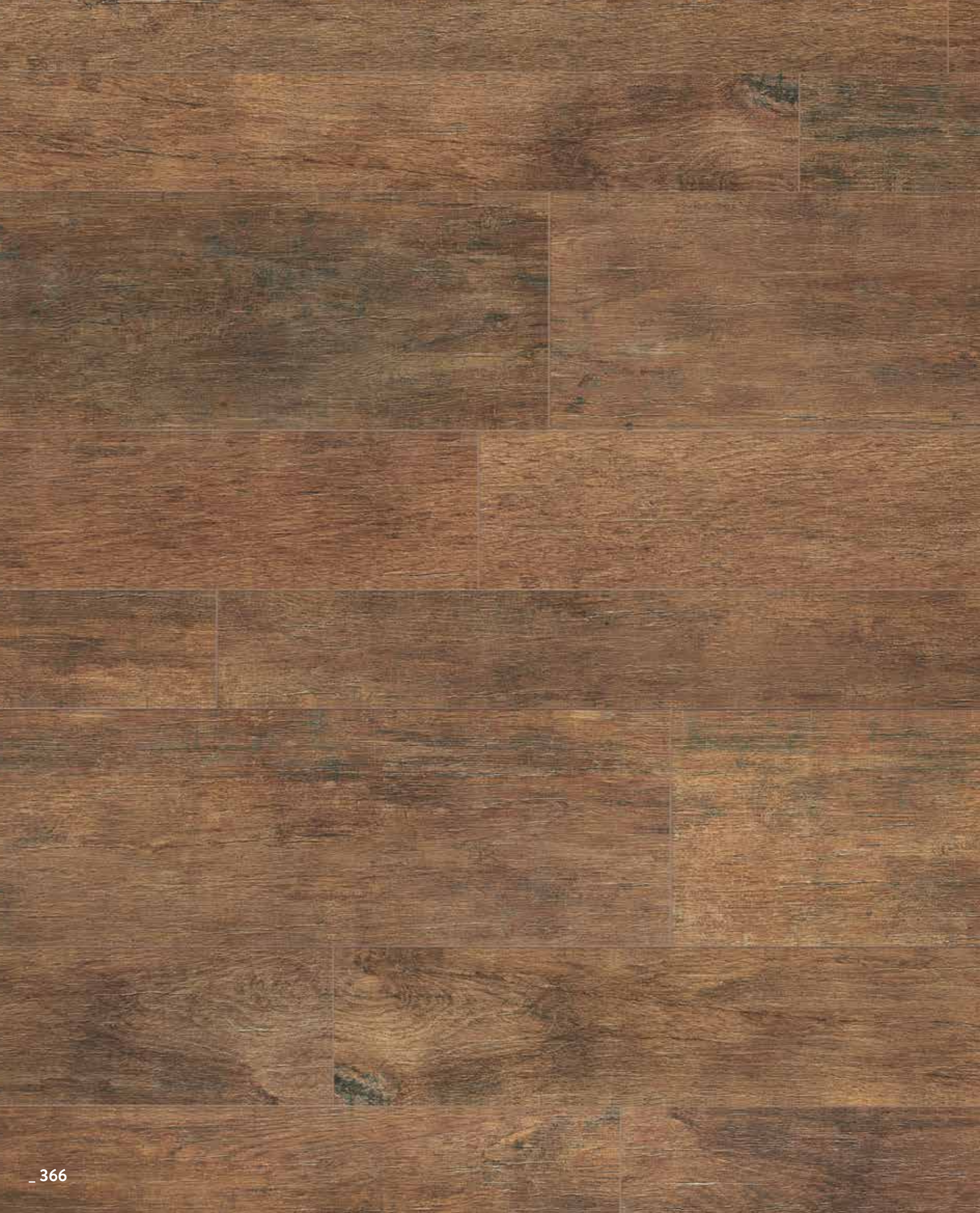

ROVERE REALE

LEGNI HIGH-TECH 

RETTIFICATO MONOCALIBRO
RECTIFIED SINGLE-CALIBRE / REKTIFIZIERT EINKALIBRIG /
RECTIFIÉ MONOCALIBRE

SPESSORE
THICKNESS / DICKE / ÉPAISSEUR

10mm

FORMATI
SIZES / FORMATE / FORMATS

120 x 30 cm
48" x 12"

120 x 20 cm
48" x 8"

120x15 cm
48" x 6"

SUPERFICI
SURFACES
OBERFLÄCHEN
SURFACES

COEFFICIENTE DI ATTRITO
FRICTION COEFFICIENT
REIBUNGSKOEFFIZIENT
COEFFICIENT DE FROTTEMENT

FORMATI / SIZES / FORMATE / FORMATS
PEZZI SPECIALI / TRIMS / FORMTEILE / PIÈCES SPÉCIALES

ANTICATO / ANTIQUED / ANTIK / ANTIQUE

AN **(R10)** A

pag. 423
pag. 423



ROVERE MOKA

LEGNI HIGH-TECH 

RETTIFICATO MONOCALIBRO
RECTIFIED SINGLE-CALIBRE / REKTIFIZIERT EINKALIBRIG /
RECTIFIÉ MONOCALIBRE

SPESSORE
THICKNESS / DICKE / ÉPAISSEUR

10mm

FORMATI
SIZES / FORMATE / FORMATS

90 x 22,5 cm
36" x 9"

90 x 15 cm
36" x 6"

90 x 11 cm
36" x 4^{1/2}"

SUPERFICI
SURFACES
OBERFLÄCHEN
SURFACES

COEFFICIENTE DI ATTRITO
FRICTION COEFFICIENT
REIBUNGSKOEFFIZIENT
COEFFICIENT DE FROTTEMENT

FORMATI / SIZES / FORMATE / FORMATS
PEZZI SPECIALI / TRIMS / FORMTEILE / PIÈCES SPÉCIALES

ANTICATO / ANTIQUED / ANTIK / ANTIQUE

AN (R11) A+B

pag. 423
pag. 423

ROVERE GRIGIO

LEGNI HIGH-TECH 

RETTIFICATO MONOCALIBRO
RECTIFIED SINGLE-CALIBRE / REKTIFIZIERT EINKALIBRIG /
RECTIFIÉ MONOCALIBRE

SPESSORE
THICKNESS / DICKE / ÉPAISSEUR

10mm

cm²

FORMATI
SIZES / FORMATE / FORMATS

90 x 22,5 cm
36" x 9"

90 x 15 cm
36" x 6"

90 x 11 cm
36" x 4^{1/2}"

SUPERFICI
SURFACES
OBERFLÄCHEN
SURFACES

COEFFICIENTE DI ATTRITO
FRICTION COEFFICIENT
REIBUNGSKOEFFIZIENT
COEFFICIENT DE FROTTEMENT

FORMATI / SIZES / FORMATE / FORMATS
PEZZI SPECIALI / TRIMS / FORMTEILE / PIÈCES SPÉCIALES

ANTICATO / ANTIQUED / ANTIK / ANTIQUE

AN (R11) A

pag. 423
pag. 423

ROVERE BIANCO

LEGNI HIGH-TECH 

RETTIFICATO MONOCALIBRO
RECTIFIED SINGLE-CALIBRE / REKTIFIZIERT EINKALIBRIG /
RECTIFIÉ MONOCALIBRE

SPESSORE
THICKNESS / DICKE / ÉPAISSEUR

▼
10mm
▲

FORMATI
SIZES / FORMATE / FORMATS

90 x 22,5 cm
36" x 9"



90 x 15 cm
36" x 6"

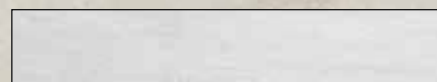

90 x 11 cm
36" x 4^{1/2}"

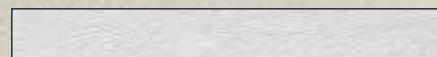

SUPERFICI
SURFACES
OBERFLÄCHEN
SURFACES

ANTICATO / ANTIQUED / ANTIK / ANTIQUE

COEFFICIENTE DI ATTRITO
FRICTION COEFFICIENT
REIBUNGSKOEFFIZIENT
COEFFICIENT DE FROTTEMENT

AN **(R10)** A+B+C

FORMATI / SIZES / FORMATE / FORMATS
PEZZI SPECIALI / TRIMS / FORMTEILE / PIÈCES SPÉCIALES

pag. 423
pag. 423



RETTIFICATO MONOCALIBRO
RECTIFIED SINGLE-CALIBRE / REKTIFIZIERT EINKALIBRIG /
RECTIFIÉ MONOCALIBRE

SPESORE
THICKNESS / DICKE / ÉPAISSEUR

▼
10mm
▲

FORMATI
SIZES / FORMATE / FORMATS

90 x 22,5 cm
36" x 9"

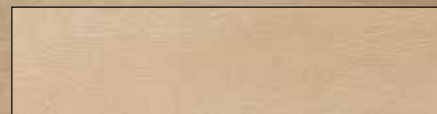

90 x 15 cm
36" x 6"

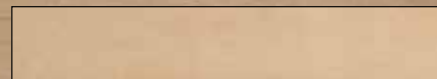

90 x 11 cm
36" x 4^{1/2}"

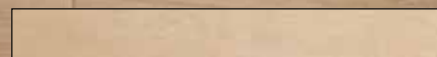

SUPERFICI
SURFACES
OBERFLÄCHEN
SURFACES

ANTICATO / ANTIQUED / ANTIK / ANTIQUE

COEFFICIENTE DI ATTRITO
FRICTION COEFFICIENT
REIBUNGSKOEFFIZIENT
COEFFICIENT DE FROTTEMENT

AN **(R10)** A+B

FORMATI / SIZES / FORMATE / FORMATS
PEZZI SPECIALI / TRIMS / FORMTEILE / PIÈCES SPÉCIALES

pag. 423
pag. 423

ROVERE CILIEGIO

LEGNI HIGH-TECH 

RETTIFICATO MONOCALIBRO
RECTIFIED SINGLE-CALIBRE / REKTIFIZIERT EINKALIBRIG /
RECTIFIÉ MONOCALIBRE

SPESSORE
THICKNESS / DICKE / ÉPAISSEUR

10mm

FORMATI
SIZES / FORMATE / FORMATS

90 x 22,5 cm
36" x 9"

90 x 15 cm
36" x 6"

90 x 11 cm
36" x 4¹/₂"

SUPERFICI
SURFACES
OBERFLÄCHEN
SURFACES

COEFFICIENTE DI ATTRITO
FRICTION COEFFICIENT
REIBUNGSKOEFFIZIENT
COEFFICIENT DE FROTTEMENT

FORMATI / SIZES / FORMATE / FORMATS
PEZZI SPECIALI / TRIMS / FORMTEILE / PIÈCES SPÉCIALES

ANTICATO / ANTIQUED / ANTIK / ANTIQUE

AN (R10) A+B

pag. 423
pag. 423



ROVERE ANTICO

LEGNI HIGH-TECH 

RETTIFICATO MONOCALIBRO
RECTIFIED SINGLE-CALIBRE / REKTIFIZIERT EINKALIBRIG /
RECTIFIÉ MONOCALIBRE

SPESSORE
THICKNESS / DICKE / ÉPAISSEUR

10mm

FORMATI
SIZES / FORMATE / FORMATS

90 x 22,5 cm
36" x 9"

90 x 15 cm
36" x 6"

90 x 11 cm
36" x 4^{1/2}"

SUPERFICI
SURFACES
OBERFLÄCHEN
SURFACES

COEFFICIENTE DI ATTRITO
FRICTION COEFFICIENT
REIBUNGSKOEFFIZIENT
COEFFICIENT DE FROTTEMENT

FORMATI / SIZES / FORMATE / FORMATS
PEZZI SPECIALI / TRIMS / FORMTEILE / PIÈCES SPÉCIALES

ANTICATO / ANTIQUED / ANTIK / ANTIQUE

AN **(R10)** A

pag. 423
pag. 423

ROVERE ABBAZIA

LEGNI HIGH-TECH 

RETTIFICATO MONOCALIBRO
RECTIFIED SINGLE-CALIBRE / REKTIFIZIERT EINKALIBRIG /
RECTIFIÉ MONOCALIBRE

SPESSORE
THICKNESS / DICKE / ÉPAISSEUR

▼
10mm
▲

FORMATI
SIZES / FORMATE / FORMATS

90 x 22,5 cm
36" x 9"

90 x 15 cm
36" x 6"

90 x 11 cm
36" x 4^{1/2}"

SUPERFICI
SURFACES
OBERFLÄCHEN
SURFACES

ANTICATO / ANTIQUED / ANTIK / ANTIQUE

COEFFICIENTE DI ATTRITO
FRICTION COEFFICIENT
REIBUNGSKOEFFIZIENT
COEFFICIENT DE FROTTEMENT

AN **(R10)** A

FORMATI / SIZES / FORMATE / FORMATS
PEZZI SPECIALI / TRIMS / FORMTEILE / PIÈCES SPÉCIALES

pag. 423
pag. 423



[Redacted text block]

[Redacted text block]

[Redacted text block]

[Redacted text block]

[Redacted text block]

[Redacted text block]

[Redacted text block]

ROVERE NERO

LEGNI HIGH-TECH 

RETTIFICATO MONOCALIBRO
RECTIFIED SINGLE-CALIBRE / REKTIFIZIERT EINKALIBRIG /
RECTIFIÉ MONOCALIBRE

SPESSORE
THICKNESS / DICKE / ÉPAISSEUR

▼
10mm
▲

FORMATI
SIZES / FORMATE / FORMATS

90 x 22,5 cm
36" x 9"

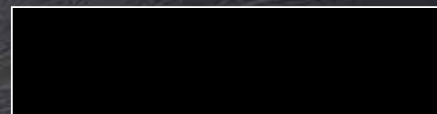

90 x 15 cm
36" x 6"

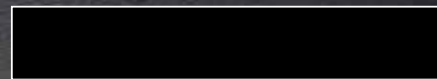

90 x 11 cm
36" x 4 1/2"



SUPERFICI
SURFACES
OBERFLÄCHEN
SURFACES

ANTICATO / ANTIQUED / ANTIK / ANTIQUE

COEFFICIENTE DI ATTRITO
FRICTION COEFFICIENT
REIBUNGSKOEFFIZIENT
COEFFICIENT DE FROTTEMENT

AN (R10) A+B

FORMATI / SIZES / FORMATE / FORMATS
PEZZI SPECIALI / TRIMS / FORMTEILE / PIÈCES SPÉCIALES

pag. 423
pag. 423

ARTIC

WOODDRAW

RETTIFICATO MONOCALIBRO

RECTIFIED SINGLE-CALIBRE / REKTIFIZIERT EINKALIBRIG /
RECTIFIÉ MONOCALIBRE

SPESSORE

THICKNESS / DICKE / ÉPAISSEUR

$\frac{8\text{ mm}}{\triangle}$

FORMATI

SIZES / FORMATE / FORMATS

120 x 20 cm

48" x 8"

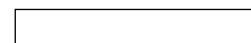

SUPERFICI / SURFACES / OBERFLÄCHEN / SURFACES

ANTICATO / ANTIQUED / ANTIK / ANTIQUE

COEFFICIENTE DI ATTRITO

FRICITION COEFFICIENT
REIBUNGSKOEFFIZIENT
COEFFICIENT DE FROTTEMENT

AN **(R9)**

FORMATI pag. 422

SIZES pag. 422 / FORMATE pag. 422 / FORMATS pag. 422



ASH

WOODDRAW

RETTIFICATO MONOCALIBRO

RECTIFIED SINGLE-CALIBRE / REKTIFIZIERT EINKALIBRIG /
RECTIFIÉ MONOCALIBRE

SPESSORE

THICKNESS / DICKE / ÉPAISSEUR

$\frac{8\text{ mm}}{\triangle}$

FORMATI

SIZES / FORMATE / FORMATS

120 x 20 cm

48" x 8"

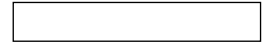

SUPERFICI / SURFACES / OBERFLÄCHEN / SURFACES

ANTICATO / ANTIQUED / ANTIK / ANTIQUE

COEFFICIENTE DI ATTRITO

FRICITION COEFFICIENT

REIBUNGSKOEFFIZIENT

COEFFICIENT DE FROTTEMENT

AN (R9)

FORMATI pag. 422

SIZES pag. 422 / FORMATE pag. 422 / FORMATS pag. 422



BOARD

WOODRAW

RETTIFICATO MONOCALIBRO

RECTIFIED SINGLE-CALIBRE / REKTIFIZIERT EINKALIBRIG /
RECTIFIÉ MONOCALIBRE

SPESSORE

THICKNESS / DICKE / ÉPAISSEUR

▼
8 mm
▲

FORMATI

SIZES / FORMATE / FORMATS

120 x 20 cm

48" x 8"

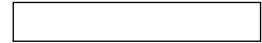

SUPERFICI / SURFACES / OBERFLÄCHEN / SURFACES

ANTICATO / ANTIQUED / ANTIK / ANTIQUE

COEFFICIENTE DI ATTRITO

FRICITION COEFFICIENT

REIBUNGSKOEFFIZIENT

COEFFICIENT DE FROTTEMENT

AN (R9)

FORMATI pag. 422

SIZES pag. 422 / FORMATE pag. 422 / FORMATS pag. 422



POWDER

WOODRAW

RETTIFICATO MONOCALIBRO

RECTIFIED SINGLE-CALIBRE / REKTIFIZIERT EINKALIBRIG /
RECTIFIÉ MONOCALIBRE

SPESSORE

THICKNESS / DICKE / ÉPAISSEUR

$\frac{8\text{ mm}}{\triangle}$

FORMATI

SIZES / FORMATE / FORMATS

120 x 20 cm

48" x 8"

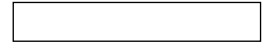

SUPERFICI / SURFACES / OBERFLÄCHEN / SURFACES

ANTICATO / ANTIQUED / ANTIK / ANTIQUE

COEFFICIENTE DI ATTRITO

FRICITION COEFFICIENT

REIBUNGSKOEFFIZIENT

COEFFICIENT DE FROTTEMENT

AN (R9)

FORMATI pag. 422

SIZES pag. 422 / FORMATE pag. 422 / FORMATS pag. 422



RUST

WOODDRAW

RETTIFICATO MONOCALIBRO

RECTIFIED SINGLE-CALIBRE / REKTIFIZIERT EINKALIBRIG /
RECTIFIÉ MONOCALIBRE

SPESSORE

THICKNESS / DICKE / ÉPAISSEUR

8 mm

FORMATI

SIZES / FORMATE / FORMATS

120 x 20 cm

48" x 8"



SUPERFICI / SURFACES / OBERFLÄCHEN / SURFACES

ANTICATO / ANTIQUED / ANTIK / ANTIQUE

COEFFICIENTE DI ATTRITO

FRICION COEFFICIENT

REIBUNGSKOEFFIZIENT

COEFFICIENT DE FROTTEMENT

AN (R9)

FORMATI pag. 422

SIZES pag. 422 / FORMATE pag. 422 / FORMATS pag. 422

IRIDIUM

NERO

IRIDIUM

RETTIFICATO MONOCALIBRO

RECTIFIED SINGLE-CALIBRE / REKTIFIZIERT EINKALIBRIG /
RECTIFIÉ MONOCALIBRE

SPESSORE

THICKNESS / DICKE / ÉPAISSEUR

▼
10mm
▲

FORMATI

SIZES / FORMATE / FORMATS

60 x 60 cm
24" x 24"



60 x 30 cm
24" x 12"

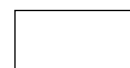

BIANCO

SUPERFICI / SURFACES / OBERFLÄCHEN / SURFACES

LEVIGATO E LUCIDATO / HONED AND POLISHED /
GESCHLIFFEN UND POLIERT / POLI ET LUSTRÉ

SOFT

FORMATI pag. 421

SIZES pag. 421 / FORMATE pag. 421 / FORMATS pag. 421

PEZZI SPECIALI pag. 421

TRIMS pag. 421 / FORMTEILE pag. 421 / PIÈCES SPÉCIALES pag. 421

A close-up photograph showing a person's hands wearing white work gloves, unrolling a large roll of light-colored, textured material onto a tiled floor. The material is being unrolled from the left side of the frame. The floor consists of large, light-colored square tiles with dark grout. The lighting is soft and even.

LA POSA /
INSTALLATION /
DIE VERLEGUNG /
LA POSE

LA POSA Alla totale riuscita di un pavimento Ariostea concorrono, insieme alle qualità tecniche ed estetiche del materiale, elementi quali sottofondo, strato legante, giunti di dilatazione, che costituiscono un vero e proprio sistema pavimento. Solo la corretta esecuzione delle operazioni di posa assicura un perfetto risultato finale. La posa deve essere preferibilmente eseguita con collanti idonei, attenendosi alle istruzioni della ditta produttrice degli stessi. Nei luoghi ad elevato transito o con passaggio di carichi pesanti è consigliabile il sistema a doppia spalmatura. I materiali Ariostea tendono a simulare la casualità della natura con le sue variazioni

INSTALLATION In addition to the technical and aesthetic qualities of the material used, the total success of an Ariostea floor installation depends on a series of elements such as bed, adhesive layer and expansion joints, which make up a true flooring system. A correct installation is therefore essential in order to ensure perfect final results. The installation should be preferably made using proper adhesives, following the instructions provided by the manufacturer. In places subject to heavy traffic or to the passage of heavy loads it is advisable to perform installation at double spread.

DIE VERLEGUNG Das perfekte Gelingen eines Bodenbelags von Ariostea hängt außer von den technischen und ästhetischen Materialeigenschaften auch von einer Reihe anderer Faktoren ab: Untergrund, Bindschicht, Dehnungsfugen. Diese bilden ein regelrechtes Fußbodensystem. Nur durch eine fachgerechte Verlegung kann daher ein optimales Endergebnis erzielt werden. Die Verlegung muss am besten mit geeigneten Klebstoffen erfolgen, und es wird angeraten, die Angaben des jeweiligen Herstellers genau zu befolgen. In Räumen mit hoher Begehungsfrequenz oder bei Beanspruchung durch schwere Lasten empfiehlt sich die Verlegung an doppelter Ausbreitung. Die Fliesen von Ariostea haben die Neigung, die für Naturprodukte typische Zufälligkeit mit ihren Farbvariationen nachzubilden, die ein guter Fliesenleger bei

LA POSE La réussite totale d'un sol Ariostea dépend non seulement des qualités techniques et esthétiques du matériau mais aussi de divers éléments (fond, couche de liant et joints de dilatation) qui constituent un véritable système sol. Seules des opérations de pose correctes garantissent un résultat final parfait. De préférence, la pose doit être effectuée par des adhésifs appropriés, et il est conseillé de se conformer aux instructions du fabricant. Dans les endroits très fréquentés ou soumis au passage de charges lourdes, il est recommandé d'utiliser le système à la double diffusion. Les matériaux Ariostea imitent le hasard de la nature et ses variations de couleurs,

CONSIGLI PER LA POSA DEL CM2 Precisiamo che tutti i formati della collezione CM2 di Ariostea sono idonei per la posa direttamente su massetto, su ghiaia, su sabbia e su erba mentre per la posa in applicazione sopraelevata si devono invece tenere in considerazione alcune specificità in funzione del formato. Nella posa di Ariostea CM2 nel formato 60x60 in applicazione sopraelevata si raccomanda un innalzamento massimo del piano di appoggio non superiore a 10 cm. Si consiglia inoltre l'utilizzo del supporto centrale (5° piedino), per distribuire in modo corretto i vari carichi ed incrementare ulteriormente i già elevati valori di resistenza ai carichi del materiale.

TIPS FOR LAYING CM2 Please note that all of the formats of the CM2 collection of Ariostea are suitable for laying directly on concrete, gravel, sand and on grass while for the laying in an elevated application it is necessary to take into account certain characteristics according to the format. For the laying of Ariostea CM2 in the 60x60 format in an elevated application the elevation of the support surface should not exceed 10 cm. It is also recommended to use the central support (5th leg), to distribute properly the different loads and further increase the already high resistance values of the material to the loads. It is also possible to use 60 x 60 plates

TIPPS FÜR CM2 VERLEGE Wir halten fest, dass alle Formate der Kollektion CM2 von Ariostea geeignet sind, direkt auf Beton, Kies, Sand und Gras verlegt zu werden, während bei einem erhöhten Verlegen einige vom Format diktierte Maßnahmen zu berücksichtigen sind. Bei einem erhöhten Verlegen von Ariostea CM2 der Größe 60x60 ist empfohlen, die Auflagefläche um nicht mehr als 10 cm anzuheben. Zudem ist empfohlen, die zentrale Stütze (5. Bein) zu verwenden, um so die unterschiedlichen Belastungen auszugleichen und die an sich schon bedeutende Tragfähigkeit des Materials zu erhöhen. Es ist auch möglich, die Verwendung von Platten des Formats 60 x 60 und einer Dicke von 20 mm in Höhen von mehr als 10 cm vorzusehen, wobei allerdings

CONSEILS POUR LA POSE CM2 Précisons que tous les formats de la collection CM2 d'Ariostea conviennent pour la pose directement sur le béton, le gravier, le sable et l'herbe, tandis que pour la pose en surélévation, il faut prendre en compte certaines spécificités en fonction du format. Dans la pose d'Ariostea CM2 au format 60x60, il est recommandé pour la pose surélevée une hauteur maximale de la surface d'appui ne dépassant pas 10 cm. Il est recommandé également d'utiliser un support central (5e pied), pour distribuer au mieux les différentes charges et augmenter encore les valeurs déjà élevées de résistance aux charges matérielles. Il est également possible d'envisager l'utilisation de dalles de 60x60 en 20 mm

cromatiche, che l'abilità del posatore può esaltare. Per valorizzare al meglio le caratteristiche del materiale, si consiglia di seguire, durante la posa in opera, le seguenti prescrizioni:

- Stendere a terra alcuni pezzi (almeno 3 mq.) per controllare l'effetto d'insieme. Posare il materiale attingendone da più scatole.
- Non immergere in acqua il materiale prima della posa.
- Soprattutto nelle superfici levigate, per i tagli non segnare la parte superiore da posare con matite o pennarelli.
- Attendere 48-72 ore prima di sottoporre il pavimento al normale transito.

Ariostea products tend to replicate the random appearance of natural materials, with their characteristic colour variations, which the skills of the installer can even enhance. Follow these instructions to bring out the best in the material:

- Spread out a number of pieces (at least 3 square metres) on the floor to check the overall effect. When laying the material, mix contents of different boxes.
- Do not immerse the material in water before laying.
- With polished surfaces in particular, do not mark the up per surfaces with pencils or marker pens where cut are needed.
- Wait 48-72 hours before subjecting the floor to normal use.

seiner Arbeit zu nutzen weiß. Um die Materialeigenschaften am besten zur Geltung zu bringen, wird empfohlen, während der Verlegung vor Ort die folgenden Hinweise zu befolgen:

- Legen Sie einige Fliesen (mind. 3 m²) auf dem Boden aus, um die Gesamtwirkung zu testen. Entnehmen Sie das Material aus verschiedenen Kartons.
- Legen Sie das Material vor dem Verlegen nicht in Wasser.
- Vor allem bei polierten Oberflächenausführungen vermeiden Sie, den Schnittverlauf an der zu verlegenden Materialoberfläche mit Bleistift oder Filzstift aufzuzeichnen.
- Die normale Begehungsfrequenz wird nur nach 48-72 Stunden erlaubt.

caractéristiques que l'habileté du carreleur peut exalter. Afin de rehausser au mieux les caractéristiques du matériau, il est conseillé de suivre, lors de la pose, les indications suivantes:

- Etaler quelques carreaux sur le sol (au moins 3 m²) pour contrôler l'effet d'ensemble. Prélever le matériau de plusieurs boîtes.
- Ne pas immerger le matériau dans l'eau avant la pose.
- Pour la coupe des carreaux, et notamment des surfaces polies, ne pas écrire au crayon ou au feutre sur la face visible.
- Attendre de 48 à 72 heures avant de marcher sur le sol.

È anche possibile prevedere l'utilizzo di lastre di 60x60 in 20 mm di spessore ad altezze superiori ai 10 cm previa applicazione per incollaggio di una rete in fibra di vetro nella parte sottostante della lastra per sopraelevazioni fino a 30 cm. Per sopraelevazioni fino a 50 cm prevedere un foglio di lamiera zincata. In questi ultimi due casi sono sufficienti 4 supporti per lastra. Per la posa sopraelevata di Ariostea CM2 nei formati 120x60 e 120x30 si raccomanda di non superare i 2 cm di altezza prevedendo 7 supporti per il 120x60 e 6 per il 120x30, mentre per pavimentazioni con innalzamento tra 2 e 10 cm è indispensabile una rete in fibra di vetro e oltre i 10 cm di altezza si dovrà utilizzare un foglio di lamiera zincata.

with a thickness of 20 mm and a maximum height of 10 cm after application by bonding of a glass fibre netting in the underlying part of the plate for elevations up to 30 cm. For elevations up to 50 cm a galvanized steel plate will be required. In the latter two cases 4 supports for each plate are enough. For the elevated laying of Ariostea CM2 in the 120x60 and 120x30 formats it is recommended not to exceed 2 cm in height using 7 supports for 120x60 and 6 for 120x30, while for floorings with an elevation between 2 and 10 cm a glass fibre netting is essential and for over 10 cm a galvanized steel plate will be required.

für Erhöhungen von bis zu 30 cm ein Glasfaser-Netz auf den unter der Platte vorgesehenen Bereich verklebt werden muss. Für Erhöhungen von bis zu 50 cm ist dafür ein Blatt verzinkten Blechs vorzusehen. In den letzten beiden Fällen sind vier Träger je Platte ausreichend. Für das erhöhte Verlegen von Ariostea CM2 in den Größen 120x60 und 120x30 ist empfohlen, eine Höhe von 2 cm nicht zu überschreiten, wobei 7 Träger je 120x60 und 6 je 120x30 vorzusehen sind, während für zwischen 2 und 10 cm erhöhte Bodenbeläge ein Glasfaser-Netz und bei mehr als 10 cm ein Blatt verzinkten Blechs zu verwenden sind.

d'épaisseur à des hauteurs supérieures à 10 cm après application par collage d'un filet en fibres de verre à la partie inférieure de la dalle pour des surélévations allant jusqu'à 30 cm. Pour des surélévations allant jusqu'à 50 cm, prévoir une tôle d'acier galvanisé. Dans les deux derniers cas, il suffit de 4 supports par dalle. Pour la pose surélevée d'Ariostea CM2 dans les formats 120x60 et 120x30, il est recommandé de ne pas dépasser 2 cm de hauteur en prévoyant 7 supports pour 120x60 et 6 pour 120x30, alors que pour un dallage entre 2 et 10 cm, un filet en fibres de verre est indispensable ; au-delà de 10 cm de hauteur, il faudra utiliser une tôle d'acier galvanisé.

SMANTELLAMENTO DEL PAVIMENTO La selezione dei materiali da costruzione in funzione della loro durabilità è un elemento fondamentale per la sostenibilità ambientale di un edificio. Infatti un materiale con un ciclo di vita più lungo, con la stessa funzione d'uso di un altro, determina un impatto ambientale minore. I materiali Ariostea, se correttamente installati, possono durare quanto

FLOORING REMOVAL The selection of construction materials on the basis of their durability is fundamental to create an environmentally sustainable building. A material with the same function as another one but a longer life cycle has a lesser environmental impact. When properly installed, Ariostea materials last as long as the building they are placed in. Moreover, at the end of their life

ABBRUCH DES BODENBELAGS Die Auswahl der Baumaterialien nach ihrer Lebensdauer ist ein grundlegender Faktor für die Umweltverträglichkeit eines Gebäudes. In der Tat hat ein Material mit einem längeren Lebenszyklus und dem selben Verwendungszweck eines anderen geringere Umweltauswirkungen. Die Ariostea Materialien können, wenn sie richtig verlegt werden, so lange halten, wie das Gebäude, in dem sie sich befinden. Am Ende des Lebenszyklus

DÉPOSE DE PLANCHER Sélectionner les matériaux de construction en fonction de leur durabilité est fondamental pour déterminer la compatibilité écologique d'un bâtiment. En effet, un matériau avec un cycle de vie plus long et la même fonction qu'un autre, a un impact moindre sur l'environnement. Les matériaux Ariostea, s'ils sont correctement installés, peuvent durer aussi longtemps que le bâtiment où ils ont été posés. En outre, à la fin du cycle de

l'edificio in cui sono stati collocati. Inoltre, alla fine del ciclo di vita, i residui derivanti dalla loro demolizione non richiedono trattamenti poiché, in virtù dell'elevata inerzia chimica, non rilasciano sostanze nell'ambiente. Il rifiuto generato dovrà essere recuperato o smaltito, nel rispetto delle normative nazionali e locali vigenti.

cycle, the demolition waste does not require treatment since it does not release any substances into the environment, thanks to its high chemical inertia. The waste generated must be salvaged or disposed of in accordance with the state and local regulations in force.

dieser Produkte verlangen die beim Abbruch entstehenden Reste zudem keine Aufbereitung, da sie aufgrund ihrer hohen chemischen Inertheit keine Substanzen in die Umwelt abgeben. Die entstehende Abfälle müssen unter Beachtung der nationalen und örtlichen Bestimmungen rückgewonnen oder entsorgt werden.

vie de ces produits, les résidus de démolition ne requièrent pas de traitements; en effet leur inertie chimique étant élevée, aucune substance n'est libérée dans l'environnement. Le déchet produit devra être récupéré ou éliminé, conformément aux réglementations nationales et locales en vigueur.

STUCCATURA E PULIZIA FINALE / JOINTING AND FINAL CLEANING / VERFUGUNG UND ENDREINIGUNG / JOINTOIEMENT ET NETTOYAGE FINAL

STUCCATURA E PULIZIA FINALE Con collanti a presa normale, stuccare il pavimento dopo 24/48 ore, se si utilizzano adesivi rapidi dopo 4h.
- Soprattutto sui materiali levigati lucidati utilizzare stucchi cementizi con colori tono su tono, evitando su materiali chiari, stucchi di colore scuro e viceversa. Per la stuccatura di queste superfici non adoperare stucchi epossidici o malte flessibili a base di materiali sintetici (Flexfughe) soprattutto se a contrasto col colore del materiale e non aggiungere additivi/lattici allo stucco. Essi infatti rendono estremamente difficoltosa l'eliminazione dei residui con i normali prodotti di pulizia. Se si decide comunque di utilizzare questa tipologia di stucco, testarli sempre prima sul materiale.
- Stendere lo stucco con spatola gommata su tutta la superficie del materiale.
- Stuccare piccole superfici per volta, asportando le quantità eccedenti con spugne o stracci umidi (di sola acqua pulita) o utilizzare apposite macchine per togliere lo stucco eccedente, quando ancora il velo di stucco è umido.

JOINTING AND FINAL CLEANING When the floor has been laid using normal setting adhesives, joint the tiles after 24/48 hours, in the case of quick setting adhesives, after 4 hours.
- Especially with honed and polished materials, use cement-based grout with tone on tone colours (if possible avoid dark coloured grouts like black, blue, red with light coloured materials and vice-versa). For jointing these surfaces, do not use epoxy grouts or flexible mortar with a synthetic base (Flexfughe) especially if the colour contrasts with the material and do not add additives/latex to the grout. These products in fact make it extremely difficult to eliminate the residues with normal cleaning products. Should this kind of grout be used anyway, take care of testing it on the material beforehand.
- Spread the grout with a rubber spatula all over the material surface.
- Joint small areas at a time, removing the excess with damp sponges or rags (using only clean water) or with special machines for removing the excess grout

- Un'adeguata pulizia iniziale è fondamentale sia per valorizzare la brillantezza, sia per assicurare la pulibilità e la semplicità di manutenzione ordinaria. La pulizia iniziale va quindi effettuata immediatamente dopo la posa, utilizzando prodotti a base acida, strofinando energicamente e sciacquando abbondantemente con acqua. In questo modo sarà possibile eliminare i residui di stucco, collante, cemento, ecc. E' possibile utilizzare tutti i detergenti disponibili sul mercato, con unica esclusione dei prodotti contenenti acido fluoridrico (composti e derivati) come previsto dalla norma EN 14411.
- **Si raccomanda una accurata protezione del pavimento posato. Qualora sia necessario eseguire altre operazioni quali tinteggiatura, lavori idraulici o qualsiasi altro lavoro, si consiglia, terminata la posa, di coprire il pavimento con teli PVC o AIRBALLS o tessuti.**

while this is still damp.
- Proper initial cleaning is fundamental both for enhancing its aesthetic and shine characteristics and for restoring its original characteristics of easy cleaning and ease of ordinary maintenance. It is therefore very important that initial cleaning is carried out immediately after installation, rubbing hard with acid-based products, followed by abundant rinsing with water. In this way it will be possible to eliminate the residues of grout, adhesive, cement, etc. It is possible to use any of the detergents available on the market, with the exclusion only of products containing hydrofluoric acids (composites and derivatives) according to EN standard 14411.
- **The floor must be carefully protected. Should it be necessary to carry out other operations such as decorating, plumbing or any other kind of work, once the floor has been installed it is advisable to cover it with PVC or AIRBALLS sheets or cloths.**

VERFUGUNG UND ENDREINIGUNG Bei der Verlegung mit normal härtenden Klebern, den Boden nach 24 / 48 Stunden, bei der Verwendung von Schnellklebern bereits nach 4 Stunden verfugen.

- Insbesondere auf den glanzpolierten Materialien sollten Zementkitt in ähnlichen Farbtönen verwendet werden (es sollte vermieden werden, auf hellen Materialien dunkle, beispielsweise schwarze, blaue oder rote Kitt zu verwenden; dasselbe gilt für helle Kitt auf dunklen Fliesen).

- Für das Verfugen dieser Oberflächen auf keinen Fall kunstharzgebundenen Fugenmörtel oder bewegliche Mörtel auf Basis von synthetischen Materialien (z.B. Flexfughe) verwenden, vor allem nicht in Kontrastfarbe zur Fliese. Außerdem dürfen dem Kitt keine Zusatzstoffe oder Latex zugeschlagen werden, da durch diese Zuschläge die Entfernung der Restrückstände mit den normalen Reinigungsmitteln extrem erschwert wird. Sollen Sie sich dennoch für einen kunstharzgebundenen Fugenmörtel entscheiden, testen Sie diesen vorher auf dem Material.

- Den Kitt mit einer Gummisspachtel auf der gesamten Materialoberfläche gleichmäßig auftragen.

- Die kleinen Oberflächen einzeln verfugen und die entsprechenden Restrückstände mit einem feuchten Schwamm oder Lappen (der nur in reines Wasser getaucht wurde) entfernen, oder spezielle Maschinen für das Entfernen

von Restrückständen verwenden, wobei der Kitt noch feucht sein muß.

- Eine korrekte anfängliche Reinigung ist besonders wichtig, weil somit sowohl die ästhetischen Besonderheiten und der Glanz des Materials hervorgehoben werden, und zudem die zukünftigen und lang anhaltenden Eigenschaften der einfachen Reinigung und der praktischen regelmäßigen Pflege dieses Materials zur Geltung kommen können.

Es ist deshalb sehr wichtig, daß die erste Reinigung mit säurehaltigen Reinigungsmitteln sofort nach der Verlegung des Materials erfolgt, wobei die Fliesen fest zu reiben und dann gründlich mit frischem Wasser zu spülen sind. Auf diese Weise können alle Restrückstände von Kitt, Kleber, Zement usw. gründlich entfernt werden. Zu diesem Zweck können alle erhältlichen Reinigungsmittel verwendet werden, mit Ausnahme aller Produktartikel, die Fluorwasserstoffsäure (Verbindungen und Derivate) enthalten, laut der Vorschrift EN 14411.

- **Es wird empfohlen, den verlegten Boden sorgfältig zu schützen. Sollten andere Arbeiten, wie zum Beispiel das Färben, das Verlegen von Heizungs und Wasserleitungen oder ähnliches erforderlich sein, empfehlen wir den Boden nach dem Verlegen mit Planen aus PVC, AIRBALLS oder Gewebbahnen abzudecken.**

JOINTOIEMENT ET NETTOYAGE FINAL En cas de pose avec des adhésifs à prise normale, jointoyer le sol après 24/48 heures; si l'on utilise des adhésifs à prise rapide, après 4h.

- Sur les matériaux polis lustrés surtout, utiliser des mortiers-joints avec des couleurs ton sur ton (éviter si possible sur des matériaux de couleur claire des mortiers de couleur foncée comme le noir, le bleu, le rouge et vice-versa).

Pour le jointoiment de ces surfaces, ne pas utiliser Mastics époxydes ou de mortiers flexibles à base de matériaux synthétiques (Flexfughe) surtout s'il y a contraste avec la couleur du matériau, et ne pas ajouter d'additifs/lactiques au mastic. En effet, ces derniers rendent l'élimination des résidus extrêmement difficile avec les nettoyeurs normaux. Si de toute façon on décide de continuer à utiliser ce type de mortier il faudra toujours le tester avant.

- Etaler le mortier à la spatule caoutchoutée sur toute la surface du matériau.

- Jointoyer de petites surfaces à la fois en enlevant les quantités en excès avec une éponge ou des chiffons humidifiés (exclusivement d'eau propre) ou utiliser des machines spéciales pour enlever le mortier en excès quand le voile de

mortier est encore humide.

- Un nettoyage initial adapté est d'une importance fondamentale aussi bien pour mettre en valeur les caractéristiques esthétiques et de brillance, que pour rétablir les caractéristiques de facilité de nettoyage et d'entretien ordinaire. C'est la raison pour laquelle il est fondamental que le nettoyage initial soit effectué immédiatement après la pose, en utilisant des produits à base acide, en frottant énergiquement et, par la suite, en frottant abondamment avec de l'eau. Il sera ainsi possible d'éliminer les résidus de mortier, d'adhésif, de ciment, etc. Il est possible d'utiliser tous les nettoyeurs disponibles sur le marché, à l'exception des produits contenant de l'acide fluorhydrique (composés et dérivés) comme le prévoit la norme EN 14411.

- **Il est recommandé de protéger soigneusement le sol posé. S'il s'avère nécessaire d'exécuter d'autres opérations comme la peinture, les travaux de plomberie ou autre, une fois la pose terminée, nous conseillons de couvrir le sol avec des bâches en PVC ou AIRBALLS ou avec du tissu.**

PULIZIA E MANUTENZIONE / CLEANING AND MAINTENANCE / REINIGUNG UND PFLEGE / NETTOYAGE ET ENTRETIEN

PULIZIA E MANUTENZIONE Il termine "pulibilità" identifica la capacità di un materiale di consentire la rimozione dello sporco e della polvere che si depositano sulla superficie, al fine di garantire le necessarie condizioni di igiene. Nei materiali Ariostea tale prerogativa, legata direttamente alla compattezza della superficie, alla sua impermeabilità e alla resistenza agli agenti chimici, è di altissimo livello. Inoltre i materiali Ariostea sopportano senza problemi l'azione di solventi e prodotti particolari che ne agevolano la pulitura, essendo resistenti all'azione degli acidi e delle basi, anche concentrati, fatta eccezione per i prodotti contenenti acido fluoridrico. Possono quindi essere effettuati trattamenti di pulizia piuttosto energici, con l'ausilio di macchine, salvaguardando le condizioni igieniche anche in ambienti soggetti a forti condizioni di sporcabilità.

È importante sottolineare che nelle operazioni quotidiane di pulizia dei materiali levigati è sufficiente lavare i pavimenti con normali detergenti non grassi, mentre vanno assolutamente evitate cere o altre sostanze per conservare la brillantezza della superficie. Il grado di visibilità dello sporco e di semplicità di manutenzione in materiali non smaltati può essere tuttavia condizionato dal colore scelto. Colori molto chiari o molto scuri, richiedono rispetto ad altri, una manutenzione più accurata. La specifica documentazione Ariostea indica i detergenti più adatti sia per la pulizia ordinaria sia per lo sporco particolarmente resistente. Su richiesta sono disponibili i rapporti delle prove di resistenza alle macchie effettuate su campioni di materiali Ariostea con superfici naturali, strutturate e levigate.

CLEANING AND MAINTENANCE The term “cleanability” means the ability of a material to permit the removal of dirt and dust settled on the surface in order to guarantee the required hygienic conditions. As this feature is tightly linked with the surface compactness and impermeability and with the material’s resistance to chemical agents, Ariostea products offer outstanding cleanability. Moreover, Ariostea materials easily withstand the action of solvents and special cleaning products as they are resistant to the action of acids and bases, even in high concentrations (except for products containing hydrofluoric acid). Particularly powerful cleaning treatments, using machines too, can be carried out without problems, thus ensuring hygienic conditions even in spaces subject to high levels of dirtying. As to the daily cleaning of polished materials, it is

REINIGUNG UND PFLEGE Mit dem Begriff Reinigungsfähigkeit bezeichnet man die Eigenschaft eines Materials, die es erlaubt, auf der Oberfläche abgelagerten Schmutz und Staub zu entfernen, um die notwendige Hygiene zu gewährleisten. Die Materialien von Ariostea haben diesen Vorzug, der in direktem Zusammenhang mit der Kompaktheit und Wasserundurchlässigkeit der Oberfläche und seiner Widerstandsfähigkeit gegen Chemikalien steht. Außerdem vertragen die Materialien von Ariostea problemlos die Einwirkung von Lösungsmitteln und Spezialmitteln zur Erleichterung der Reinigung, da sie selbst gegen konzentrierte Säuren und Basen beständig sind (ausgenommen Produkte, die Fluorwasserstoffsäure enthalten). Ohne Probleme lassen sich dadurch selbst die energischen Reinigungsvorgänge auch mit entsprechenden Maschinen ausführen, so dass die hygienischen Voraussetzungen auch in Räumen, die besonders starker Verschmutzung ausgesetzt sind, sichergestellt werden

NETTOYAGE ET ENTRETIEN L’expression “facile à nettoyer” identifie la facilité avec laquelle un matériau est libéré de la saleté et de la poussière accumulées sur sa surface afin de garantir les conditions d’hygiène nécessaires. Cette prérogative, directement liée à la compacité de la surface, à son imperméabilité ainsi qu’à sa résistance aux agents chimiques, est très élevée dans les matériaux Ariostea. De même, ces derniers résistent sans problème aux solvants et aux produits spéciaux, ce qui facilite leur nettoyage puisqu’ils ne craignent ni les acides ni les bases, même à forte concentration, à l’exception des produits à base d’acide fluorhydrique. Par conséquent, des traitements plutôt énergiques peuvent être effectués au moyen de nettoyeurs pour préserver d’excellentes conditions d’hygiène, même dans des locaux soumis à des activités très salissantes. Il est important de

important to note that floors can simply be washed with common non-greasy detergents. Never use wax or other substances to preserve surface sheen. Nevertheless, the level of dirt visibility on and the ease of maintenance of an unglazed material can also be affected by the type of colour chosen. In fact, very bright or very dark colours require more thorough maintenance with respect to other colours.

Ariostea’s relevant documentation lists the most suitable detergents for regular cleaning operations and for particularly stubborn dirt. Stain resistance test reports on samples of Ariostea materials with natural, textured, and polished finishes are available on request.

können. Zur täglichen Reinigung ist der Hinweis wichtig, dass es auch bei polierten Fliesen ausreicht, die Böden mit normalen nicht fettenden Reinigungsmitteln zu säubern, während Bohnerwachs oder andere glanzhaltende Wischpflege unbedingt zu vermeiden sind. Die Sichtbarkeit des Schmutzes und die einfache Pflege von unglasiertem Material kann jedoch auch vom gewählten Farbton abhängen. Sehr helle oder sehr dunkle Farbtöne erfordern eine sorgfältigere Pflege als andere Farbtöne. Sie finden in den entsprechenden Unterlagen von Ariostea Angaben zu den Reinigungsmitteln, die sich jeweils am besten für die gewöhnliche Pflege bzw. für hartnäckige Verschmutzungen eignen. Auf Anfrage sind die Ergebnisse der Tests zur Fleckenbeständigkeit erhältlich, die an Materialproben - sowohl matte, strukturierte als auch polierte Oberflächen - von Ariostea durchgeführt wurden.

souligner que pour le nettoyage quotidien des matériaux polis, il suffit de laver les sols avec des détergents ordinaires non gras alors qu’il faut absolument éviter les cires ou autres substances pour conserver l’éclat de la surface. Le degré de visibilité de la saleté et la facilité d’entretien des matériaux non émaillés peuvent cependant dépendre de la couleur choisie. En effet, les couleurs très claires ou, au contraire, très foncées, exigent un type d’entretien plus soigné. Les détergents les plus appropriés, tant pour l’entretien ordinaire que pour la saleté particulièrement tenace, sont mentionnés dans la documentation spécifique Ariostea.

Nous fournissons, sur demande, les rapports des essais de résistance aux taches effectués sur des échantillons de matériaux Ariostea avec finition mate, structurée et polie.

PAVIMENTI SOPRAELEVATI / RISED FLOORS / DOPPELBÖDEN / PLANCHERS SURÉLEVÉS

PAVIMENTI SOPRAELEVATI Il pavimento sopraelevato è un sistema di pavimentazione concepito per rispondere alle diverse esigenze degli ambienti di lavoro ad alta concentrazione di impiantistica, che permette il passaggio di cablaggi e connessioni di ogni genere o che può essere utilizzato per il passaggio dell’aria. Questo sistema permette rapidi ed efficaci interventi di manutenzione e modifica di cablaggi e connessioni, grazie alla possibilità di smontare a secco le lastre, senza la necessità di modifica delle opere murarie, limitando in questo modo tempi e costi degli interventi.

Rispetto ai pavimenti tradizionali, tali sistemi polifunzionali sono una perfetta sintesi tra praticità progettuale, coerenza architettonica e funzionalità, durata nel tempo, razionalità e tecnologia ambientale: per tutti questi motivi i pavimenti sopraelevati sono il sistema edilizio oggi più impiegato in uffici, show-room, concessionarie e in tutti gli spazi ad attività produttive.

Il materiale ARIOSTEA si sposa perfettamente con questo sistema, in quanto associa soluzioni estetiche pregiate a caratteristiche fisico-meccaniche di eccellenza, offrendo lastre con diversi formati e finiture fra loro assemblabili,

per consentire la massima flessibilità progettuale.

Inoltre, grazie all’ampia varietà dei materiali Ariostea e alla tecnica del taglio computerizzato ad idrogetto, l’ufficio tecnico Ariostea è in grado di fornire una valida assistenza per la progettazione di pavimentazioni personalizzate.

Pavimento sopraelevato per esterno Novità nel campo edilizio, il pavimento sopraelevato per esterno viene concepito per applicare la completa flessibilità del sistema anche nella pavimentazione di zone esterne, solitamente risolte con soluzioni tradizionali, permettendo l’ispezione degli elementi sottostanti al nuovo piano di calpestio (ad es. tubazioni con funzione di scolo per l’acqua piovana, pozzetti e griglie).

Composto da due semplici elementi, quali supporti portanti prefabbricati in polipropilene e lastre di finitura, il pavimento sopraelevato per esterno contribuisce ad eliminare risalite di umidità, problemi di gelate e infiltrazioni d’acqua, e permette il passaggio di impianti e tubazioni.

RAISED FLOORS A raised floor is a flooring system designed to meet the different requirements of working areas with a high concentration of mechanical systems. The system permits cabling and connections of all kinds to be passed through it or it can be used for ventilation.

This system permits rapid and effective maintenance and changes to cabling and connections because the slabs can be removed dry with no need for masonry work, thus reducing time and cost. Compared to traditional flooring, such poly-functional systems are a perfect combination of practicality of design, architectural coherence and functionality, durability, rationality and environmentally-friendly technology: for all these reasons, raised flooring is nowadays the building system most commonly used in offices, show rooms, dealerships and in all production areas.

ARIOSTEA is a material that works well with this system because it combines fine aesthetic solutions with excellent physical-mechanic characteristics, offering panels in various sizes and finishes that can be assembled together,

enabling maximum design flexibility.

Moreover, thanks to the ample choice of Ariostea and computerised hydrojet cutting, Ariostea's technical department is able to provide support for the design of customised flooring.

Raised floors for exteriors A very recent addition in the building field, raised flooring for exteriors brings all the system's flexibility to paving outdoor areas as well, where traditional solutions are normally used; it allows for the inspection of elements underneath the new treadable surface such as rainwater drain pipes, inspection holes and grills).

The solution combines two simple elements: pre-fabricated, polypropylene load-bearing supports and finishing slabs. Raised flooring for exteriors can help to eliminate problems of rising damp, frost and water infiltration and allows for the passage of systems and pipes.

DOPPELBÖDEN Der Doppelboden ist ein Bodensystem für die verschiedenen Anforderungen in Arbeitsumgebungen mit einer hohen Anlagendichte. Er ermöglicht das Verlegen von Verkabelungen und Verbindungen aller Art und kann auch zur Luftleitung benutzt werden.

Dieses System ermöglicht rasche und effiziente Wartungs- und Änderungsarbeiten an Verkabelungen und Verbindungen, da die Platten ohne Notwendigkeit von Änderungen am Mauerwerk trocken abmontiert werden können. Auf diese Weise kann bei den Arbeiten Zeit und Geld gespart werden. Im Vergleich zu herkömmlichen Böden sind diese Multifunktionssysteme eine perfekte Synthese aus praktischer Planung, architektonischer Kohärenz und Funktionalität, langer Haltbarkeit, Rationalität und Umwelttechnologie: Aus all diesen Gründen sind Hochböden heute das meistangewandte Bausystem in Büros, Ausstellungsräumen, bei Vertragshändlern und in allen Räumen für Produktionstätigkeiten. Das Material von ARIOSTEA - verschmilzt perfekt mit diesem System, da es hochwertige ästhetische Lösungen mit hervorragenden physikalischen und mechanischen Eigenschaften verbindet. Es bietet Platten in verschiedenen Formaten und Ausführungen, die untereinander zusammengebaut werden können, um so die größtmögliche Flexibilität bei der

Planung zu ermöglichen.

Außerdem ist das technische Büro von Ariostea dank der großen Vielfalt der Materialien von Ariostea und der computergesteuerten Schneidetechnik mit Wasserstrahl imstande, Sie bei der Planung von individuell gestalteten Böden zu unterstützen.

Doppelboden für den aussenbereich Eine Neuheit auf dem Gebiet des Baus ist der Doppelboden für den Außenbereich. Er wurde entwickelt, um die komplette Flexibilität des Systems auch bei Böden im Außenbereich anwenden zu können, wo bislang üblicherweise herkömmliche Lösungen verwendet wurden. Mit ihm kann man Elemente inspizieren, die unterhalb der neuen begehbaren Ebene liegen (z.B. Rohrleitungen für den Abfluss von Regenwasser, Schächte und Gitter).

Er besteht aus zwei einfachen Elementen, nämlich vorgefertigten tragenden Teilen aus Polypropylen und oberflächenbehandelten Platten. Der Doppelboden für den Außenbereich trägt dazu bei, das Aufsteigen von Feuchtigkeit, Vereisungsprobleme und Einsickern von Wasser auszumerzen und ermöglicht die Verlegung von Anlagen und Rohrleitungen.

PLANCHERS SURÉLEVÉS Le plancher surélevé est un système de sol conçu pour répondre aux diverses exigences des espaces de travail à haute concentration d'installations techniques, permettant le passage de câblages et de connexions de toutes sortes et pouvant aussi être utilisé pour le passage de l'air.

Grâce à la possibilité de démonter les panneaux à sec sans avoir besoin d'intervenir sur les travaux de maçonnerie, ce système permet d'effectuer rapidement et efficacement des interventions d'entretien et de modification des câblages et des connexions, limitant ainsi les délais et les coûts d'intervention.

Comparés aux planchers traditionnels, ces systèmes polyfonctionnels sont une synthèse parfaite entre la commodité de conception, la cohérence architecturale et la fonctionnalité, la longévité, la rationalité et la technologie ambiante : pour toutes ces raisons, les planchers surélevés sont le système le plus utilisé aujourd'hui dans le bâtiment pour les bureaux, les showrooms, les concessionnaires et pour tous les espaces à activités productives.

En associant des solutions esthétiques de qualité à des caractéristiques physico-mécaniques d'excellence, le matériel ARIOSTEA s'adapte parfaitement à ce système, en offrant des panneaux de divers formats et finitions pouvant

s'assembler entre eux pour consentir la plus grande flexibilité conceptuelle possible.

Par ailleurs, grâce à la grande variété des matériels Ariostea et à la technique de la découpe informatisée à hydrogène, le service Ariostea peut fournir une assistance de qualité pour la projection de planchers personnalisés.

Plancher surélevé pour extérieur Nouveauté dans le domaine du bâtiment, le plancher surélevé pour extérieur est également conçu pour appliquer la flexibilité totale du système au sol des zones externes, habituellement résolues par des solutions traditionnelles, en permettant l'inspection des éléments situés au-dessous du nouveau plan de piétinement (par ex. conduits d'écoulement de l'eau de pluie, puits et grilles).

Composé de deux simples éléments, des supports portants préfabriqués en polypropylène et des panneaux de finition, le plancher surélevé pour extérieur contribue à éliminer les remontées d'humidité, les problèmes de gel et d'infiltrations d'eau et permet le passage des installations techniques et des conduites.

PARETI VENTILATE I rivestimenti esterni degli edifici ricoprono un ruolo di primaria importanza nell'architettura contemporanea e nella qualificazione del paesaggio urbano, oltre a svolgere un'importante funzione di protezione degli agenti atmosferici. Essi garantiscono una notevole valorizzazione estetico-prestazionale dell'edificio, nettamente superiore alla muratura tradizionale.

Il rivestimento esterno montato in facciata ventilata crea un'intercapedine d'aria che "allontana" dalla parete muraria sia gli agenti atmosferici che il calore creato dalle radiazioni solari, producendo un'efficienza termica ed un conseguente risparmio energetico ed economico sia nella stagione calda che in quella fredda, ovvero riduce nel periodo estivo il carico di calore sull'edificio, e viceversa trattiene all'interno il calore nella stagione invernale.

VENTILATED FAÇADES External facing on buildings plays a crucial role in contemporary architecture and the development of the urban landscape. It also has the important function of providing protection from atmospheric agents and it significantly improves the building's aesthetic and performance aspects, which are markedly superior to traditional walls. The external facing mounted on the ventilated façade creates an air space that "protects" the wall from atmospheric agents and from solar radiation heat producing thermal efficiency and providing subsequent energy and financial savings both in warm and cool seasons. In the summer, it reduces the heat load on the building and does the opposite in the winter by keeping the heat inside the building.

HINTERLÜFTETE FASSADEN Die Außenverkleidungen der Gebäude spielen eine außerordentlich wichtige Rolle in der modernen Architektur und der Gestaltung des städtischen Landschaftsbildes. Außerdem üben sie eine bedeutende Schutzfunktion gegen Witterungseinflüsse aus. Sie garantieren eine beachtliche Ästhetik- und Leistungsaufwertung des Gebäudes, die weit über der von einem traditionellen Mauerwerk gewährleisteten liegt. Die Außenverkleidung, die durch eine hinterlüftete Fassade realisiert wird, bildet einen Luftzwischenraum, der das Mauerwerk vor Witterungseinflüssen sowie vor der von den Sonneneinstrahlungen verursachten Wärme „schützt“. Er erzeugt eine thermische Effizienz und hat somit eine höhere Energie- und Kosteneinsparung sowohl in der warmen, als auch in der kalten Jahreszeit zur Folge, d.h. er vermindert in der Sommerzeit die Wärmebelastung für das Gebäude und bewahrt in der Winterzeit die Wärme im Gebäudeinnern. Weitere Eigenschaften, die sich den vorrangigen Vorteilen hinzufügen, sind

FAÇADES VENTILEES Les revêtements externes des bâtiments jouent un rôle primordial dans l'architecture contemporaine et dans la qualification du paysage urbain. Ils ont également une fonction importante de protection contre les agents atmosphériques. Ils garantissent une valorisation importante, nettement supérieure à une maçonnerie traditionnelle, tant du point de vue esthétique que des prestations du bâtiment.

Le bardage externe monté sur la façade ventilée crée un matelas d'air qui éloigne du mur aussi bien les agents atmosphériques que la chaleur générée par les rayons solaires. Il provoque donc une action thermique efficace, en engendrant un gain énergétique et économique tant pendant la saison chaude que pendant la saison froide. En effet, ce système réduit la charge de chaleur qui frappe le bâtiment pendant l'été et, vice-versa, il garde la chaleur à l'intérieur pendant l'hiver.

Ai vantaggi principali si aggiungono la dispersione del vapore acqueo, il miglioramento dell'isolamento acustico e la riduzione degli interventi manutentivi. Il materiale tecnico a massa compatta di ARIOSTEA, grazie alle proprie caratteristiche (elevata resistenza meccanica, agli sbalzi termici, inalterabilità dei colori alla luce, assorbimento d'acqua pressoché nullo, ingelività e leggerezza delle lastre) è da ritenersi particolarmente idoneo per l'utilizzo in facciata ventilata, sia con aggancio visibile, che a scomparsa (non visibile).

Inoltre i materiali Ariostea consentono con la loro ricchezza di cromie e superfici, un'ampia flessibilità progettuale, garantendo risultati estetici di alto livello e prestazioni elevate in termini di durata nel tempo, facilità di posa e ridotta manutenzione.

An additional advantage is the dispersion of water vapour, which improves insulation and reduces the need for maintenance.

ARIOSTEA blocks are considered to be especially suited for use in ventilated façades (good mechanical resistance, resistant to temperature changes, the colours do not fade, it absorbs almost no water, it does not freeze and the blocks are lightweight), and come with both visible and hidden (invisible) hooks. Moreover Ariostea materials allow, thanks to their varied array of colours and surfaces, wide design flexibility that guarantees high-level aesthetic results and high performance in terms of duration in time, as well as easy installation and reduced maintenance.

die Wasserdampfdiffusion, die Verbesserung der Schalldämmung und die Reduzierung von Wartungs- und Instandhaltungsarbeiten.

Das technische kompakte Material von ARIOSTEA erweist sich, dank seiner Eigenschaften (hohe mechanische Festigkeit, Temperaturwechselbeständigkeit, Lichtbeständigkeit der Farben, ausgesprochen geringe Wasseraufnahme, Frostbeständigkeit und das geringe Gewicht der Platten) als besonders geeignet für die Verwendung bei hinterlüfteten Fassaden, sowohl mit sichtbarer Befestigung, als auch mit verdeckter Befestigung (nicht sichtbar).

Zudem ermöglichen die Materialien von Ariostea mit ihrer Vielfalt an Farben und Oberflächenausführungen beträchtliche Gestaltungsmöglichkeiten und gewährleisten dabei ästhetische Ergebnisse von hohem Niveau und sehr hoher Leistungsfähigkeit, was Lebensdauer, einfache Verlegung und Pflegeleichtigkeit betrifft.

Il faut aussi ajouter l'élimination de la condensation, l'amélioration de l'isolation acoustique et la réduction des interventions d'entretien aux avantages essentiels susmentionnés.















Le matériau technique à masse compacte ARIOSTEA est particulièrement approprié pour l'utilisation sur des façades ventilées, comme couche d'accrochage visible ou invisible, de par ses caractéristiques (résistance mécanique élevée aux sautes de température, inaltérabilité des couleurs aux rayons UV, absorption de l'eau quasiment nulle, matériau non gélif, légèreté des plaques).

De plus, les matériaux Ariostea confèrent, grâce au large éventail de coloris et de surfaces, une grande flexibilité aux projets, en garantissant des résultats esthétiques de haut niveau et des prestations élevées en termes de durée dans le temps, de facilité de pose et d'entretien réduit au minimum.

INFORMAZIONI E CODICI /
INFORMATION AND CODES /
INFORMATIONEN UND ARTIKELNR. /
CODES ET INFORMATIONS

**CARATTERISTICHE TECNICHE / TECHNICAL FEATURES /
TECHNISCHE EIGENSCHAFTEN / CARACTÉRISTIQUES TECHNIQUES**

CLASSIFICAZIONE ENTE CEN SECONDO LE NORME EN - ISO GRUPPO BIa-UGL EN 14411 ALL.G E ISO 13006 ALL.G / CLASSIFICATION IN ACCORDANCE WITH CEN AND ISO STANDARDS - BIa-UGL EN 14411 ANNEX G AND ISO 13006 ANNEX G / KLASSIFIZIERUNG GEMÄß CEN UND ISO NORMEN GRUPPE BIa-UGL EN 14411 ANL. G UND ISO 13006 ANL.G / CLASSIFICATION SELON LES NORMES CEN ET ISO GROUPE BIa-UGL EN 14411 P.J.G ET ISO 13006 P.J.G

	PROPRIETÀ CHIMICO - FISICHE / CHEMICAL / PHYSICAL PROPERTIES / CHEMISCH PHYSISCHE EIGENSCHAFTEN / PROPRIÉTÉS CHIMICO - PHYSIQUES	NORMA / REGULATION / NORMEN / NORME	VALORE PRESCRITTO / REQUIRED VALUE / VORGESCHRIEBENER WERT / VALUER PRESCRITE	VALORI MEDI ARIOSTEA / ARIOSTEA AVERAGE VALUES / ARIOSTEA DURCHSCHNITTSWERTE / VALEURS MOYENNES ARIOSTEA
	ASSORBIMENTO D'ACQUA WATER ABSORPTION / WASSERAUFNAHME / ABSORPTION D'EAU	ISO 10545-3	≤ 0,5 %	0,03% - 0,06% SÚPERFICI NATURALI, STRUTTURATE E SOFT/ NATURAL, STRUCTURED AND SOFT SURFACES/ NATURBELASSENE, STRUKTURIERTE UND SOFT OBERFLÄCHEN/ SURFACES NATURELLES, STRUCTURÉES ET SOFT 0,05% - 0,07% SÚPERFICI LUCIDATO, LEVIGATO SILK/ LUCIDATO, LEVIGATO SILK STRUCTURED LUCIDATO, LEVIGATO SILK OBERFLÄCHEN/ SURFACES LUCIDATO, LEVIGATO SILK
	DIMENSIONI SIZES / ABMESSUNGEN / DIMENSIONS	ISO 10545-2	± 0,6% max LUNGHEZZA E LARGHEZZA / LENGHT AND WIDTH / LÄNGE UND BREITE / LONGUEUR ET LARGEUR ± 5% max SPESSORE / THICKNESS / STÄRKE / EPAISSEUR ± 0,5% max RETTILINEITÀ* SPIGOLI / LINEARITY / KANTENGERADHEIT / RECTITUDE DES ARÊTES ± 0,5% max ORTOGONALITÀ* / WEDGING / RECHTWINKLIGKEIT / ORTHOGNALITÉ ± 0,5% max PLANARITÀ* / WARPAGE / EBENFLÄCHIGKEIT / PLANÉITÉ	± 0,1% LUNGHEZZA E LARGHEZZA / LENGHT AND WIDTH / LÄNGE UND BREITE / LONGUEUR ET LARGEUR ± 5% SPESSORE / THICKNESS / STÄRKE / EPAISSEUR ± 0,1% RETTILINEITÀ* SPIGOLI / LINEARITY / KANTENGERADHEIT / RECTITUDE DES ARÊTES ± 0,1% ORTOGONALITÀ* / WEDGING / RECHTWINKLIGKEIT / ORTHOGNALITÉ ± 0,2% PLANARITÀ* / WARPAGE / EBENFLÄCHIGKEIT / PLANÉITÉ
	ASPETTO / APPEARANCE / AUSSEHEN / ASPECT		95% MIN. ESENTE DA DIFETTI / MIN. 95% DEFECT FREE / MINDESTENS ZU 95% FEHLERFREI / 95% MIN. SANS DÉFAUTS	CONFORME / CONFORMS / KONFORM / CONFORME
	RESISTENZA ALL'ABRASIONE PROFONDA / DEEP ABRASION RESISTANCE / TIEFVERSCHLEISSBESTÄNDIGKEIT / RESISTANCE A L'ABRASION PROFONDE	ISO 10545-6	max 175 mm ³	140 mm ³
	RESISTENZA AI PRODOTTI CHIMICI RESISTANCE TO CHEMICAL PRODUCTS / CHEMIKALIENBESTÄNDIGKEIT / RESISTANCE AUX PRODUITS CHIMIQUES	ISO 10545-13	<small>Resistenza prodotti chimici uso domestico e additivi per piscina (min. classe B) - Resistenza acidi e alcalini a bassa concentrazione - Resistenza acidi e alcalini a alta concentrazione / Resistance to household chemicals and pool additives (min. class B) - Resistance to acids and alkalis at low concentration - Resistance to highly concentrated acid and alkaline products / Haushaltschemikalien und Pooladditive Bestandigkeit (min. Klasse B) / Alkali- und Säurebeständigkeit in niedriger Konzentration / Hochkonzentrierte Säure- und Alkalibeständigkeit / Resistance aux produits chimiques, usage domestique et additifs pour piscine (classe B minimum) / Resistance aux acides et alcalins à concentration faible / Resistance aux acides et alcalins à concentration élevée.</small>	DISPONIBILI A RICHIESTA LE CLASSIFICAZIONI DI OGNI SINGOLO ARTICOLO / CLASSIFICATIONS FOR SINGLE ITEMS AVAILABLE ON REQUEST / KLASSIFIZIERUNGEN FÜR JEDEN EINZELNEN ARTIKEL SIND AUF ANFRAGE ERHÄLTlich / LES CLASSIFICATIONS DE CHAQUE ARTICLE SONT DISPONIBLES SUR DEMANDE
	RESISTENZA ALLE MACCHIE STAIN RESISTANCE / FLECKENBESTÄNDIGKEIT / RESISTANCE AUX TACHES	ISO 10545-14	METODO DI PROVA DISPONIBILE / TESTING METHOD AVAILABLE/ VERFÜGBARES PRÜFVERFAHREN / MÉTHODE D'ESSAI DISPONIBILE	DISPONIBILI A RICHIESTA LE CLASSIFICAZIONI DI OGNI SINGOLO ARTICOLO / CLASSIFICATIONS FOR SINGLE ITEMS AVAILABLE ON REQUEST / KLASSIFIZIERUNGEN FÜR JEDEN EINZELNEN ARTIKEL SIND AUF ANFRAGE ERHÄLTlich / LES CLASSIFICATIONS DE CHAQUE ARTICLE SONT DISPONIBLES SUR DEMANDE
	MODULO DI ROTTURA (R) MODULS OF RUPTURE (R) / BRUCHMODUL (R) / MODULE DE RUPTURE (R)	ISO 10545-4	≥ 35 N/mm ²	49 N/mm ²
	SFORZO DI ROTTURA (S) BREAKING STRENGHT (S) / BRUCHKRAFT (S) / FORCE DE RUPTURE (S)		SPESSORE / THICKNESS/ STÄRKE/ EPAISSEUR: a) ≥ 7,5mm = ≥ 1300 N b) < 7,5mm = ≥ 700 N	SPESSORE / THICKNESS/ STÄRKE/ EPAISSEUR: a) 2500 N * b) CONFORME/ CONFORMS/ KONFORM/ CONFORME
	RESISTENZA SBALZI TERMICI RESISTANCE TO THERMAL SHOCKS / TEMPERATURWECHSELBESTÄNDIGKEIT / RESISTANCE AUX ECARTS DE TEMPERATURE	ISO 10545-9	METODO DI PROVA DISPONIBILE / TESTING METHOD AVAILABLE/ VERFÜGBARES PRÜFVERFAHREN / MÉTHODE D'ESSAI DISPONIBILE	RESISTENTE / RESISTANT / BESTÄNDIG / RESISTANT
	RESISTENZA COLORI ALLA LUCE RESISTANCE TO LIGHT/ LICHTBESTÄNDIGKEIT DER FARBEN/ RESISTANCE DES COULEURS A LA LUMIERE	DIN 51094	METODO DI PROVA DISPONIBILE / TESTING METHOD AVAILABLE/ VERFÜGBARES PRÜFVERFAHREN / MÉTHODE D'ESSAI DISPONIBILE	SUP. INALTERATA / UNAFFECTED SURFACE / OBERFLÄCHE UNVERÄNDERT / SURFACE INALTEREE
	DILATAZIONE TERMICA LINEARE COEFFICIENT OF LINEAR THERMAL EXPANSION / LINEARER WÄRMEAUSSDEHNUNGSKOEFFIZIENT / DILATATION THERMIQUE LINEAIRE	ISO 10545-8	METODO DI PROVA DISPONIBILE / TESTING METHOD AVAILABLE/ VERFÜGBARES PRÜFVERFAHREN / MÉTHODE D'ESSAI DISPONIBILE	6,5x10 ⁻⁶ °C ⁻¹
	RESISTENZA AL GELO / FROST RESISTANCE / FROSTBESTÄNDIGKEIT / RESISTANCE AU GEL	ISO 10545-12	RICHIESTI 100 CICLI DI GELO-DISGELO / REQUESTED 100 FREEZE-THAW CYCLES / 100 GEFRIER-AUFTAUZYKLEN ANGEFRAGT / DEMANDÉE 100 CYCLES DE GEL-DÉGEL	CONFORME / CONFORMS / KONFORM / CONFORME
	REAZIONE AL FUOCO / REACTION TO FIRE / REAKTION AUF FEUER / RÉACTION AU FEU	96/603/CE	PROVA ASSENTE / NOT APPLICABLE / NICHT NOTWENDIG / PAS D'ESSAI	A1 - A1 _{FL}
	COEFFICIENTE DI ATTRITO / FRICTION COEFFICIENT / REIBUNGSKOEFFIZIENT / COEFFICIENT DE FRICTION	BCR	μ ≥ 0,40 ATTRITO SODDISFACENTE/ SATISFACTORY FRICTION/ BEFRIEDIGENDE REIBUNG/ FRICTION SATISFAISANTE	CONFORME/ CONFORMS/ KONFORM/ CONFORME SÚPERFICI NATURALI E STRUTTURATE / NATURAL AND STRUCTURED SURFACES / NATURBELASSENE UND STRUKTURIERTE OBERFLÄCHEN / SURFACES NATURELLES ET STRUCTURÉES
		DIN 51130/51097	METODO DI PROVA DISPONIBILE / TESTING METHOD AVAILABLE/ VERFÜGBARES PRÜFVERFAHREN / MÉTHODE D'ESSAI DISPONIBILE	**

* Test effettuato su Pietre Naturali High-Tech 60x60
Test performed on Pietre Naturali High-Tech 60x60
Test mit Pietre Naturali High-Tech 60x60 durchgeführt
Essai effectuée sur Pietre Naturali High-Tech 60x60

**Vedi tabella Safe System /
See Safe System table /
Siehe Tabelle Safe System /
Voir tableau Safe System

Standards ANSI/ASTM disponibili a richiesta /
ANSI/ASTM standards available on demand /
ANSI/ASTM standards verfügbare auf Anfrage /
ANSI/ASTM standards disponibles sur demande

BRITISH PENDOLUM TEST
IN ACCORDANCE WITH BRITISH STANDARD BS 7976 - 2:2002

COLLEZIONE ARIOSTEA ARIOSTEA COLLECTIONS KOLLEKTION ARIOSTEA COLLECTION ARIOSTEA	SUPERFICIE SURFACE OBERFLÄCHE SURFACE	RISULTATO SU ASCIUTTO RESULT ON DRY ERGEBNIS WENN TROCKEN RÉSULTAT À SEC	RISULTATO SU BAGNATO RESULT ON WET ERGEBNIS WENN NASS RÉSULTAT À MOUILLÉ
PIETRE NATURALI HIGH-TECH	Strutturato / Structured Strukturisiert / Structurée	Low slip potential 36+	Low slip potential 36+
	Satinato / Satin-finish Satinier / Satiné *	Low slip potential 36+	Moderate slip potential 25-35
GREENSTONE	Strutturato / Structured Strukturisiert / Structurée **	Low slip potential 36+	Low slip potential 36+

* Test effettuato su Pietra di Merano Satinato / Test performed on satin-finish Pietra di Merano / Test mit satinierte Pietra di Merano durchgeführt / Essai effectué sur Pietra di Merano satiné

** Test effettuato su Quarzite Bianca Strutturato / Test performed on structured Quarzite Bianca / Test durchgeführt auf Quarzite Bianca strukturisiert / Essai effectué sur Quarzite Bianca structuré

SPANISH PENDOLUM TEST
ENV12633

COLLEZIONE ARIOSTEA ARIOSTEA COLLECTIONS KOLLEKTION ARIOSTEA COLLECTION ARIOSTEA	SUPERFICIE SURFACE OBERFLÄCHE SURFACE	CLASSE CLASS KLASSE CLASSE
PIETRE NATURALI HIGH-TECH	Strutturato / Structured / Strukturisiert / Structurée	2
	Satinato / Satin-finish / Satinier / Satiné *	2
LEGNI HIGH-TECH	Anticato / Antiqued / Antik / Antique **	2

* Test effettuato su Limra Satinato / Test performed on satin-finish Limra / Test mit satinierte Limra durchgeführt / Essai effectué sur Limra satiné

** Test effettuato su Rovere Moka / Test performed on Rovere Moka / Test mit Rovere Moka durchgeführt / Essai effectué sur Rovere Moka

**INFORMAZIONI TECNICHE AGGIUNTIVE / ADDITIONAL TECHNICAL INFORMATION /
ZUSÄTZLICHE TECHNISCHE INFORMATIONEN / INFORMATION TECHNIQUE SUPPLÉMENTAIRE**

- La trasformazione di materie prime naturali, associata all'utilizzo di innovative tecnologie di produzione brevettate, consente di ottenere materiali dalle elevate prestazioni tecniche, che si distinguono per i tipici effetti a tutto spessore da sempre prerogativa esclusiva dei marmi e delle pietre di cava.
- Le variazioni cromatiche, di venatura e le piccole puntature sono pertanto caratteristiche di alto pregio dei materiali Ariostea, ricercate e volute proprio al fine di ricreare la suggestione di una pavimentazione esclusiva, in cui si possa riscoprire la casualità e la bellezza dei materiali naturali. In ragione di quanto sopra i riferimenti cromatici presentati su cataloghi e campionature sono da intendersi puramente indicativi.
- Le lastre delle collezioni Ariostea sono realizzate in massa unica, compatta, ingeliva e resistente agli attacchi chimici. Esse sono pertanto una garanzia di stabilità e durezza nel tempo, idonee a qualunque impiego e ad ogni ambiente sia interno che esterno, dal più classico e raffinato, al più ampio e di intenso utilizzo.

- The processing of natural raw materials, combined with the use of leading-edge patented production techniques, makes it possible to obtain high-tech materials characterized by typical full-body effects, a feature that has always been the exclusive hallmark of quarried marble and stone.
- Chromatic variations, veining and speckling are thus prized characteristics of Ariostea materials, designed and produced to recreate the fascination of exclusive floorings, that reveal the randomness and beauty of natural materials. On the basis of the above statements, the colour references in the catalogues and samples are to be considered as approximate.
- The slabs of the Ariostea collections are realized with a 100% full body, a compact and frost-proof mass and they are resistant to chemical attacks. For this reason they are a guarantee of stability and durability in the time, suitable for whatever use and destination, both interior and exterior, from the more classic and refined, to the most spacious and of intense utilization one.

- Die Umwandlung von natürlichen Rohmaterialien mit Hilfe von innovativen und patentierten Produktionstechnologien, ermöglicht die Herstellung von Materialien mit hoher technischer Leistungsfähigkeit, die sich durch die typischen vollgemischten Effekte unterscheiden und die seit jeher die charakteristische Besonderheit der Marmorarten und der Steine aus dem Steinbruch sind.
- Die farblichen Unterschiede, die Äderungen und die kleinen Punkte sind aus diesem Grund charakteristische Eigenschaften der Materialien Ariostea von besonderem Wert. Diese "Unvollkommenheiten" sind besonders gewählt und gewollt, um einen exklusiven Bodenbelag zu erzielen, bei dem die Zufälligkeit und die Schönheit der natürlichen Materialien voll zum Ausdruck kommen können. Angesichts der oben aufgeführten Tatsache sind die Farben der Kataloge und der Muster unverbindlich.
- Die Platten der Kollektione Ariostea werden in einziger, vollgemischten, kompakten, frost- und chemikalienbeständigen Masse hergestellt. Deshalb sind sie eine Garantie für Stabilität und Haltbarkeit im Laufe der Zeit, geeignet für jegliche Nutzung und für jedes Ambiente, sowohl für Innen- als Außenbereiche, von den klassischsten und raffiniertesten, bis zu den größten mit intensiver Nutzung.

- La transformation de matières premières naturelles, allée à l'application de technologies de production d'avant-garde brevetées, permet d'obtenir des matériaux capables de performances techniques élevées se distinguant par leurs effets pleine masse typiques qui sont depuis toujours la prérogative exclusive des marbres et des pierres de carrière.
- Les variations chromatiques, les veines et les petits points sont donc des caractéristiques de grande valeur des matériaux Ariostea, recherchées et voulues dans le but de recréer la suggestion d'un sol exclusif grâce auquel il est possible de redécouvrir l'impondérable et la splendeur des matériaux naturels. C'est la raison pour laquelle les références chromatiques présentées sur les catalogues et les échantillons ne sont données qu'à titre indicatif.
- Les dalles de les collections Ariostea sont réalisées en une unique masse, compacte, résistante au gel et aux attaches chimiques. Ces dalles sont donc une garantie de stabilité et durabilité dans le temps, elles sont indiquées pour toute utilisation soit pour l'intérieur que l'extérieur, pour tous endroits de plus classique et raffiné au plus large et à grand passage.

- Per ottenere un ottimo risultato estetico è preferibile posare il materiale con una fuga di 2-3 mm utilizzando stuccature in tinta.
- Ariostea si riserva di apportare modifiche senza preavviso ai prodotti, declinando ogni responsabilità per danni diretti o indiretti da eventuali modifiche.
- I colori e le caratteristiche estetiche dei prodotti sono quanto più possibile vicini a quelli reali, nei limiti consentiti dai processi di stampa.

Ultra Ariostea prevede un certo numero di facce differenti, a parità di prodotto, per creare una gradevole variabilità estetica nella posa. In fase di approntamento dell'ordine la selezione delle facce è random quindi la venatura continua tra i pezzi ordinati non è garantita. Ultra è un prodotto derivante dalla combinazione della terra con il fuoco. La eventuale continuità di venatura tra un pezzo e l'altro è soggetta alla tolleranza tipica dei prodotti naturali.

- For a better aesthetic result, is preferable to spread out the material with a 2-3 mm of joint, jointing with tone on tone colours.
- Ariostea keeps the right to change all the mentioned items without notice and declining any responsibility for direct or indirect damage caused from these changes.
- The colours and appearance features of the products are as close as possible to reality, within the limitation of the printing process.

Ultra Ariostea, compared with an equal product, provides a number of different faces, to create a pleasant aesthetic variability in the laying. In the order preparation phase, the face selection is random and therefore the continuous veining between the ordered pieces is not guaranteed. Ultra is a product derived from a combination of earth with fire. The continuous veining between pieces is subject to the typical variation of natural products.

- Um eine optimale Ästhetik zu erreichen, es ist vorzuziehen, das Material mit einer Fuge von 2-3 mm zu verlegen und Verfügungen in ähnlichen Farbtönen zu verwenden.
- Ariostea behält sich vor, ohne Ankündigung Änderungen an den Produkten vorzunehmen, und lehnt jede Haftung für direkte oder indirekte Schäden durch eventuelle Änderungen ab.
- Die Farben und ästhetischen Eigenschaften der Produkte kommen innerhalb der Möglichkeiten der Druckverfahren den tatsächlichen Eigenschaften so weit wie möglich nahe.

Ultra Ariostea - sieht eine gewisse Anzahl verschiedenartig gestalteter Oberflächen für dasselbe Produkt vor, um damit ansprechende ästhetische Variablen beim Verlegen erzielen zu können. Bei der Zusammenstellung der Bestellung wird die Auswahl der Oberflächen dem Zufall überlassen, sodass ein gleichförmiger Verlauf der Maserung zwischen den bestellten Stücken nicht gesichert ist. Ultra - ist ein Produkt, das aus dem Zusammenspiel von Erde und Feuer entstammt. Der eventuell kontinuierliche Verlauf der Maserung zwischen dem einem und dem anderen Stück unterliegt der typischen Toleranz von natürlichen Produkten.

- Pour obtenir un excellent résultat esthétique, est préférable de poser le matériau avec un joint de 2-3 mm utilisant le Jointoiment en couleurs ton sur ton.
- Ariostea se réserve le droit d'apporter, sans préavis, des modifications aux produits, et décline toute responsabilité pour dommages directs ou indirects, des éventuelles modifications.
- Les couleurs et les caractéristiques esthétiques sont fideles aux couleurs et caractéristiques reelles dans les limites des procedes d'impression.

Ultra Ariostea prévoit un certain nombre de faces différentes, pour un même produit, pour créer une agréable variabilité esthétique dans la pose. En phase de préparation de la commande, la sélection des faces est aléatoire donc le grain continu entre les pièces commandées ne peut pas être garanti. Ultra est un produit dérivé de la combinaison de la terre et du feu. La continuité éventuelle dans le grain entre une pièce et une autre est soumise à la tolérance typique des produits naturels.



**SISTEMA DI GESTIONE AMBIENTALE
CERTIFICATO UNI EN ISO 14001**

Certified environmental management system.
Umweltschutzsystem zertifiziert.
Gestion environnementale certifiée.

Certificazione ISO 14001: è un Sistema di Gestione Ambientale, che attesta la validità delle misure adottate dall'Azienda per salvaguardare l'ambiente interno ed esterno. Con questa certificazione la nostra azienda conferma il proprio impegno nell'assicurare il rispetto delle leggi relative all'ambiente, e nel gestire, preservare e, ove possibile, diminuire l'utilizzo di risorse naturali riducendo al minimo l'inquinamento.

ISO 14001 certification: this is an Environmental Management System, which demonstrates the validity of the measures adopted by the Company to protect the internal and external environment. Through this certification, our company confirms its commitment to ensuring observance of laws concerning the environment and to managing, preserving and, where possible, reducing the use of natural resources, minimising pollution.

Zertifizierung nach ISO 14001: Diese Norm legt die Gültigkeit der vom Unternehmen in Bezug das Umweltmanagement angewandten Maßnahmen im und außerhalb des Werks fest. Mit dieser Zertifikation bestätigt unser Unternehmen seinen Einsatz zur Versicherung der Berücksichtigung aller gesetzlichen Vorgaben in Bezug auf Umweltschutz und Umweltmanagement, für die Verwaltung, den Schutz und - wo möglich - einen geringeren Einsatz von natürlichen Ressourcen und somit eine Verringerung der Umweltverschmutzung.

Certification ISO 14001 : il s'agit d'un Système de management environnemental qui certifie la validité des mesures adoptées par l'entreprise pour protéger l'environnement intérieur et extérieur. Grâce à cette certification, notre entreprise affirme sa volonté de faire respecter les lois sur l'environnement, ainsi que de gérer, préserver et, si possible, diminuer l'exploitation de ressources naturelles en réduisant au minimum la pollution.



**SISTEMA DI GESTIONE QUALITÀ
CERTIFICATO UNI EN ISO 9001**

Certified quality system.
Qualitätssystem zertifiziert.
Système qualité certifié.

Certificazione ISO 9001: per la gestione del sistema di Qualità aziendale. La certificazione, valida a livello internazionale, riguarda l'intera gestione aziendale, dalla ricerca e sviluppo alla produzione, dalla distribuzione all'assistenza al cliente. Questo schema certifica che l'Azienda ha implementato un sistema di controllo della qualità aziendale.

ISO 9001 certification: for corporate Quality system management. The certification, valid at an international level, concerns corporate management in its entirety, from research and development to production, and from distribution to customer support. This system certifies that the Company has implemented an internal quality management system.

Zertifizierung nach ISO 9001: für das Qualitätsmanagement-System im Unternehmen. Die international anerkannte Norm im Qualitätsmanagement regelt alle Abläufe im Unternehmen, ausgehend von Forschung und Entwicklung, über die Produktion bis zum Vertrieb und den Kundendienst. Diese Zertifizierung bezeugt, dass das Unternehmen die Anforderungen des Qualitätsmanagementsystems in Bezug auf die Produktionsqualität erfüllt.

Certification ISO 9001 : pour le management du système de qualité de l'entreprise. Valide au niveau international, la certification s'applique à l'ensemble du management de l'entreprise, de la R&D à la production, sans oublier la distribution et le service client. Ce schéma certifie que l'entreprise a mis en œuvre un système de contrôle de la qualité de l'entreprise.

I punti di forza che sotto il profilo ambientale e qualitativo caratterizzano la produzione di Ariostea sono:

- > utilizzo di materie prime naturali a basso impatto ambientale, in quanto ampiamente diffuse sulla crosta terrestre e non a rischio di esaurimento (come invece si verifica per alcuni materiali lapidei);
- > processi produttivi ad elevate performance qualitative ed ambientali, ciò grazie a fonti energetiche pulite come il gas metano per la produzione di energia termica;
- > ridottissimi consumi di acqua, attraverso la creazione di impianti di trattamento e riciclo completo delle acque reflue industriali, provenienti soprattutto dai lavaggi degli impianti, e l'attivazione di un sistema di approvvigionamento di acqua industriale (acqua di fiume appositamente trattata). Tutto ciò permette una drastica riduzione dei consumi idrici, l'eliminazione di qualsiasi scarico di acque reflue e, soprattutto, un quasi inesistente utilizzo di acqua potabile;
- > ciclo dei materiali chiuso: ovvero non esiste generazione di scarti durante la lavorazione, grazie al sistema di recupero ed al riutilizzo di tutti i residui adottato da Ariostea;
- > riciclaggio ottimale dei rifiuti differenziati;
- > durabilità nel tempo senza particolari necessità di manutenzione, grazie alle ottime caratteristiche di igiene e di praticità dei prodotti Ariostea;
- > elevata compatibilità allo smantellamento del pavimento/rivestimento, come definito dalle attuali legislazioni. In particolare, i residui derivanti dallo smantellamento, in ragione della loro inerzia, non richiedono trattamenti particolari e possono facilmente essere riutilizzati come inerti non rilasciando alcun genere di sostanza pericolosa e non.

The salient features of Ariostea's production, in terms of environment and quality, are as follows:

- > Use of natural raw materials that ensure minimal environmental impact, being broadly available in the earth's crust and not at the risk of depletion (as in the case of various types of stone);
- > Production processes of a high quality and environmental standard, using clean sources of energy such as methane gas for the production of heat energy;
- > Minimal consumption of water. We use plants that treat and recycle all industrial waste water used mainly for cleaning the equipment, as well as an industrial water supply system (which uses appropriately treated river water). This serves to drastically reduce our consumption of water, eliminates virtually all disposal of waste water and, above all, ensures we do not use nearly any potable water;
- > Closed work cycle: this means no waste is generated during the work phase due to Ariostea's system that recovers and reuses all residue;
- > Optimal recycling of segregated waste;
- > Long-lasting durability, without any particular need for maintenance due to the excellent standards of hygiene and practicality of Ariostea's products;
- > The floor/wall tiles are designed in such a way that they can be easily taken up again, as per the law in force. In particular, any residue created when taking up the tiles does not require special treatment due to its inertia and can be easily re-used as inert matter without releasing any substances, dangerous or otherwise.



Il Sistema comunitario di ecogestione e audit (**EMAS** = Eco-Management and Audit Scheme) è uno strumento a cui possono aderire volontariamente le imprese e le organizzazioni; la nostra Azienda ha deciso di aderire ad EMAS per perseguire e rendere evidente un miglioramento costante delle proprie prestazioni ambientali, che sono rese disponibili al pubblico attraverso la dichiarazione ambientale.

Das EU-Öko-Audit (**EMAS** = Eco-Management and Audit Scheme): ist ein von der Europäischen Union entwickeltes Instrument für alle Unternehmen und Organisationen, dem unsere Firma beigetreten ist, um mit Umweltmanagement und Umweltbetriebsprüfung, die Umweltleistung des Unternehmens zu verbessern.

The **EU EMAS** (Eco-Management and Audit Scheme) is a voluntary instrument in which businesses and organisations can participate. Our Company has decided to do so in order to pursue and make visible the continuous improvement of our environmental performance, which is made available to the public through the environmental statement.

Les entreprises et organismes peuvent volontairement demander à adhérer au Système de Management Environnemental et d'Audit (**EMAS** = « Eco-Management and Audit Scheme »). Notre entreprise a décidé de faire une demande d'enregistrement afin de poursuivre et promouvoir son engagement dans l'amélioration continue de ses prestations environnementales énoncées dans la déclaration environnementale consultable par le public.



Certificazione OHSAS 18001: acronimo di Occupational Health and Safety Assessment Series. Si tratta di uno standard internazionale mirato alla valutazione del rischio attraverso un sistema di gestione della sicurezza e della salute dei lavoratori, permettendo così alle Organizzazioni un miglioramento continuo oltre al rispetto degli adempimenti legislativi.

Zertifizierung nach OHSAS 18001: Abkürzung für Occupational Health and Safety Assessment Series. Es handelt sich um eine internationale Norm zur Unterstützung der Unternehmen bei der Risikouberwachung und Gefährdungsbeurteilung über ein Arbeitsschutzmanagementsystems zum Schutz der Gesundheit der Mitarbeiter und für eine kontinuierlichen Verbesserung des Managements und der Einhaltung der geltenden Vorschriften.

OHSAS 18001 certification: an acronym for Occupational Health and Safety Assessment Series. This is an international standard directed towards risk assessment through an occupational health and safety management system, permitting organisations to continuously improve their observance of legal requirements.

Certification OHSAS 18001 : acronyme de « Occupational Health and Safety Assessment Series ». Il s'agit d'une norme internationale visant à évaluer les risques grâce à un système de management de la sécurité et de la santé des travailleurs, permettant ainsi aux organismes de mettre en place un processus d'amélioration continue et de se conformer aux dispositions législatives.



Certificazione ISO 50001: Sistemi di Gestione dell'Energia: standard internazionale che permette, attraverso l'implementazione di un sistema di gestione dell'energia, il miglioramento continuo della propria prestazione energetica, permettendo così una riduzione dell'emissione dei gas serra oltre che dei costi energetici correlati.

Zertifizierung nach ISO 50001 – Energiemanagementsystem: internationales Normenwerk zur Unterstützung von Unternehmen bei der Einführung eines Energiemanagementsystems, bei dem ihre energiebezogene Leistung durch den Aufbau von dazu notwendigen Systemen und Prozessen verbessert wird, um so den Ausstoß von Treibhausgasen zu verringern und die damit verbundenen Energiekosten zu senken.

ISO 50001 – Energy Management Systems certification: an international standard that enables continual improvement of energy performance through the implementation of an energy management system, thus permitting a reduction in greenhouse gas emissions as well as related energy costs.

Certification ISO 50001 - Systèmes de management de l'énergie : norme internationale qui permet à une entreprise, à travers la mise en place d'un système de management de l'énergie, d'améliorer continuellement ses prestations énergétiques afin de réduire les émissions de gaz à effet de serre ainsi que les coûts énergétiques qui en découlent.

Die Stärken, welche die Produktion von Ariostea in Hinsicht auf Umweltschutz und Qualitätsgesichtspunkte kennzeichnen, sind:

- > Die Verwendung von natürlichen Rohmaterialien mit geringer Umweltbelastung, die dank ihres häufigen Vorkommens keine Gefahr der Erschöpfung laufen (wie das dagegen bei einigen Steinmaterialien der Fall ist);
- > Herstellungsverfahren mit hoher Leistung in punkto Qualität und Umwelt, dies auch dank sauberer Energiequellen wie Methangas zur Erzeugung von thermischer Energie;
- > Extrem geringer Wasserverbrauch dank der Einrichtung von Wiederaufbereitungsanlagen für die Behandlung und das komplette Recycling der industriellen Abwässer, die vor allem von den Waschvorgängen der Anlagen stammen, sowie die Aktivierung eines Versorgungssystems für Industrierwasser (entsprechend behandeltes Flusswasser). All dies ermöglicht eine drastische Verringerung des Wasserverbrauchs, das Entfallen jeglicher Art der Abwasserentsorgung und was wesentlich wichtiger ist, fast absolut keinen Einsatz von Trinkwasser;
- > Ein geschlossener Materialzyklus: das bedeutet, dass dank des von Ariostea eingesetzten Wiedergewinnungs- und Wiederverwertungssystems sämtlicher Rückstände während der Verarbeitung keine Abfälle erzeugt werden;
- > Optimale Wiederverwertung der getrennten Abfälle;
- > Eine zeitlose Dauerhaftigkeit ohne besondere Wartungsmaßnahmen dank der optimalen hygienischen Eigenschaften und der Zweckmäßigkeit der Produkte von Ariostea;
- > Hohe Abrissverträglichkeit des Bodenbelags/der Wandverkleidung, so wie es die derzeitige Gesetzgebung verlangt. Insbesondere erfordern die Abrissrückstände keine besonderen Behandlungsverfahren und können leicht als inerte Stoffe wieder verwendet werden, da sie keine Art von Gefahrenstoffen beinhalten oder freigeben.

Les points forts qui sous le profil environnemental et qualitatif caractérisent la production d'Ariostea sont:

- > utilisation de matières premières naturelles à faible impact environnemental, largement répandues sur l'écorce terrestre et qui ne risquent pas de s'épuiser (comme cela est au contraire le cas pour certains matériaux lapidaires);
- > processus de production ayant des performances qualitatives et environnementales élevées, grâce à des sources énergétiques propres comme le gaz méthane pour la production d'énergie thermique;
- > consommation d'eau extrêmement réduite, grâce à la création d'installations de traitement et de recyclage complet des eaux usées, provenant surtout des lavages des installations, et l'activation d'un système d'approvisionnement d'eau industrielle (eau de fleuve correctement traitée). Tout ceci permet une réduction importante des consommations hydriques, l'élimination des évacuations d'eaux usées et, surtout, une utilisation presque inexistante d'eau potable ;
- > cycle fermé des matériaux : c'est-à-dire lorsqu'il n'y a pas de déchets générés au cours de la fabrication, grâce au système de recyclage et d'utilisation de l'ensemble des rebuts, adopté par Ariostea;
- > recyclage optimal des déchets différenciés;
- > durabilité dans le temps, sans aucun entretien, grâce aux excellentes propriétés d'hygiène et d'utilisation des produits d'Ariostea;
- > excellente compatibilité au moment de la destruction des dalles/revêtements telle que préconisée par les législations actuelles. Notamment pour les déchets provenant de la destruction, en raison de leur inertie, qui ne demandent aucun traitement particulier et qui peuvent être facilement réutilisés en tant qu'inertes qui ne génèrent aucune substance dangereuse.



Certificazione GREENGUARD: assicura che i prodotti destinati all'uso in ambienti interni siano caratterizzati dalla pressoché inesistente emissione di sostanze volatili, contribuendo alla creazione di ambienti più salutarci. La GREENGUARD Gold Certification prende in considerazione fattori di sicurezza che tengono conto di soggetti sensibili (come i bambini e gli anziani) e assicura che l'impiego di un prodotto sia accettabile in ambienti come scuole e strutture sanitarie. Tale certificazione è ampiamente riconosciuta e accettata dai programmi di edilizia sostenibile e dai regolamenti edilizi in tutto il mondo. Negli Stati Uniti, essa viene presa come riferimento dei sistemi di valutazione degli edifici CHPS (The Collaborative for High Performance Schools) e LEED (Leadership in Energy and Environmental Design). Le collezioni certificate sono consultabili al sito web <https://spot.ul.com/>

GREENGUARD Certification ensures that products intended for indoor use are characterised by practically non-existent emissions of volatile substances, contributing to the creation of healthier environments. GREENGUARD Gold Certification considers safety factors to account for sensitive individuals (such as children and the elderly), and ensures that a product is acceptable for use in environments such as schools and healthcare facilities. This certification is widely recognised and accepted by sustainable building programmes and housing regulations worldwide. In the United States, it is referenced by The Collaborative for High Performance Schools (CHPS) and the Leadership in Energy and Environmental Design (LEED) building rating systems. Certified collections are available at <https://spot.ul.com/>

Die GREENGUARD-Zertifizierung gewährleistet, dass ein für den Innenbereich bestimmtes Produkt die strengsten und umfassendsten Anforderungen an Emissionen flüchtiger organischer Verbindungen (VOCs) in die Raumluft erfüllt, was für eine gesunde Umgebung sehr wichtig ist. Die GREENGUARD Gold-Zertifizierung berücksichtigt strengere Zertifizierungskriterien, welche die Sicherheit sensiblerer Menschen wie Kinder oder Senioren stärker berücksichtigen sowie sicherstellen, dass ein Produkt zur Verwendung zum Beispiel in Schulen oder Gesundheitseinrichtungen geeignet ist. Die Zertifizierung wird weltweit von zahlreichen Zertifizierungsprogrammen für nachhaltige Bauwerke und Baureglements anerkannt. In den Vereinigten Staaten wird sie als Referenz in Bewertungssystemen von CHPS- (The Collaborative for High Performance Schools) und LEED-Gebäuden (Leadership in Energy and Environmental Design) eingesetzt. Zertifizierte Kollektionen sind auf <https://spot.ul.com/> Website

La certification GREENGUARD garantit que les produits destinés à un usage intérieur émettent le moins de substances volatiles possible, contribuant ainsi à créer des intérieurs plus sains. La certification GREENGUARD Gold englobe des facteurs de sécurité tenant compte des sujets sensibles (comme les enfants et les personnes âgées) et assure que l'utilisation d'un produit soit possible dans des intérieurs tels que les écoles et les installations sanitaires. Cette certification est largement reconnue et acceptée par les programmes de construction durable et par les réglementations du bâtiment dans le monde entier. Aux États-Unis, elle sert de référence aux systèmes d'évaluation CHPS (« The Collaborative for High Performance Schools ») et LEED (« Leadership in Energy and Environmental Design ») dans le domaine du bâtiment. Collections certifiées sont disponibles sur le site Web de <https://spot.ul.com/>



Certificazione LEED: già diffusa ed attiva in oltre 40 Paesi, il sistema di certificazione Leed (Leadership in Energy and Environmental Design) valuta ed attesta la sostenibilità ambientale, sociale ed economica degli edifici considerati nel loro complesso. Secondo i criteri di classificazione LEED, i materiali da costruzione con elevata ecosostenibilità contribuiscono all'ottenimento dei crediti elevando il punteggio dell'edificio. Si certifica che tutte le lastre presentate in questo strumento contengono una percentuale di materiale riciclato superiore al 40% in accordo alla norma ISO 14021, garantendo quindi i più alti punteggi secondo il sistema LEED. La lista aggiornata delle collezioni certificate è disponibile al sito internet www.ariostea.it

LEED Certification: already widespread and active in more than 40 countries, the LEED (Leadership in Energy and Environmental Design) certification system assesses and attests to the environmental, social and economic sustainability of buildings considered as a whole. According to the LEED classification criteria, highly environmentally sustainable construction materials contribute to achieving credits and increasing the points for the building. All the slabs presented in this instrument are certified to contain percentage of recycled material higher than 40% in accordance with the ISO 14021 standard, thus guaranteeing the highest points according to the LEED system. The updated list of certified collections is available at www.ariostea.it

LEED-Zertifizierung: Das bereits in mehr als 40 Ländern präsente und aktive Zertifizierungssystem LEED (Leadership in Energy and Environmental Design) prüft und bestätigt die umweltfreundliche, soziale und ökonomische Nachhaltigkeit der Bauten in ihrer Gesamtheit. Den Klassifizierungskriterien von LEED entsprechend tragen hochrangig ökonachhaltige Baumaterialien dazu bei, Pluspunkte für das Gebäude zu sammeln. Es wird bestätigt, dass die in diesem Instrument vorgelegten Platten einen Prozentsatz von mehr als 40 % an wiederverwerteter Mischung gemäß Norm ISO 14021 enthalten: Sie gewährleisten also nach dem LEED-System die höchsten Punktezahlen. Die aktualisierte Liste der zertifizierten Sammlungen zur Verfügung Website www.ariostea.it

Certification LEED : déjà présent et actif dans plus de 40 pays, le système de certification LEED (« Leadership in Energy and Environmental Design »), évalue et garantit la durabilité environnementale, sociale et économique des bâtiments dans leur globalité. D'après les critères de classement LEED, les matériaux de construction extrêmement durables d'un point de vue écologique permettent d'obtenir des crédits augmentant la note du bâtiment. Nous certifions que toutes les plaques présentées dans ce dispositif contiennent un pourcentage de matériaux recyclés supérieur à 40 % conformément à la norme ISO 14021, garantissant ainsi les meilleures notes calculées d'après le système LEED. La liste mise à jour des collections certifiées est disponible sur le site www.ariostea.it

Certificazione BREEAM: è tra i più diffusi standard al mondo ed è volto a misurare l'impatto ambientale degli edifici mediante l'applicazione di specifici criteri di valutazione della sostenibilità della costruzione. Il sistema di assegnazione del punteggio prevede tipologie di certificazione fissati da rigorosi parametri tecnici e di controllo qualità basati sulle più recenti tecnologie e conoscenze disponibili.

BREEAM Certification: it is the most widespread standard in the world and it is designed to measure the environmental impact of buildings by applying specific criteria for assessing the sustainability of the construction. The rating system requires types of certification determined by strict technical parameters and quality control which in turn are based on the most recent technology and knowledge available.

BREEAM-Zertifizierung: sie gehört zu den weltweit am meisten verbreiteten Standards und dient dazu, die Umweltbelastung der Gebäude mit speziellen Beurteilungskriterien der Nachhaltigkeit des Baus zu bemessen. Die Zuerkennung der Punktebewertung sieht Zertifizierungen vor, die nach strengen, auf den neuesten Technologien und Erkenntnissen aufbauenden Maßstäben von Technik und Qualitätskontrolle festgelegt sind.

Certification BREEAM : c'est l'une des normes les plus répandues au monde et elle permet de mesurer l'impact environnemental des bâtiments selon des critères précis d'évaluation de la durabilité de la construction. Le système d'attribution du score prévoit des types de certification établis selon des paramètres techniques rigoureux et des contrôles qualité basés sur technologies et les connaissances disponibles les plus récentes.

EPD®

EPD (Environmental Product Declaration): dichiarazione ambientale di prodotto di tipo III effettuata su base volontaria, che si basa sull'analisi del ciclo di vita del prodotto (secondo l'approccio "dalla culla al cancello") in accordo alla norma EN 15804. La presente dichiarazione viene redatta facendo riferimento alle linee guida delle norme UNI EN ISO 14040 e alle regole specifiche per la categoria di prodotto PCR (Product Category Rules). Tale documento descrive gli impatti ambientali legati alla produzione di una specifica quantità di prodotto delle diverse fasi, dall'estrazione delle materie prime, al trasporto, fino alla fase produttiva vera e propria. La nostra Azienda è stata la prima a certificare i propri prodotti (vedi www.environdec.com) con una EPD specifica di prodotto, convalidata da un Ente terzo indipendente. Registrazione n. S-P-01439 consultabile al sito internet www.environdec.com

EPD (Environmental Product Declaration): a voluntary type III product declaration, based on analysis of the product life cycle (with a "from cradle to gate" approach) in accordance with the EN 15804 standard. This declaration is drawn up with reference to the guidelines of the UNI EN ISO 14040 standard and the specific PCR (Product Category Rules). This document describes the environmental impact linked to the production of a specific quantity of product in its various stages, from extraction of the raw material and transport to the production phase proper. Our Company was the first to certify its products (see www.environdec.com) with specific EPD, validated by an independent third-party Body. Recording no. S-P-01439 can be found on the website www.environdec.com

EPD (Environmental Product Declaration): Es handelt sich um eine freiwillige Umweltschutzerklärung für Produkte des Typs III, welche auf einer Analyse des Lebenszyklusses des Produkts basiert (nach dem Prinzip von der Wiege bis zur Bahre) gemäß Norm EN 15804. Diese Erklärung bezieht sich auf die Richtlinien der Norm UNI EN ISO 14040 und auf die spezifischen Regeln für die Produktkategorie PCR (Product Category Rules). Das Dokument beschreibt die Umweltverträglichkeit der Produktion eines gewissen Produkts im Laufe der verschiedenen Abläufe, ausgehend von der Gewinnung der Rohstoffe bis zur effektiven Produktion. Unser Unternehmen war das erste Unternehmen, das Produkte mit einer spezifischen Produkt-EPD durch eine unabhängige Außenstellen zertifizieren lassen hat (siehe www.environdec.com). Aufnahmen. S-S-P-01439 auf dem Internet zugegriffen www.environdec.com

EPD (Environmental Product Declaration) : déclaration environnementale concernant les produits de type III faite volontairement, qui se base sur l'analyse du cycle de vie du produit (selon l'approche « de l'extraction à la fin de vie »), conformément à la norme EN 15804. La présente déclaration a été rédigée en suivant les lignes directrices des normes UNI EN ISO 14040 et les règles spécifiques pour la catégorie de produits PCR (Product Category Rules). Ce document décrit les impacts environnementaux liés à la production d'une quantité spécifique de produit lors des différentes phases : de l'extraction des matières premières, en passant par le transport et jusqu'à la phase de production à proprement parler. Notre entreprise a été la première à faire certifier ses produits (consultez le site www.environdec.com) avec une EPD spécifique de produit, validée par un organisme tiers indépendant. Enregistrement. S-S-P-01439 accessibles sur Internet www.environdec.com



See Official Listing

La certificazione NSF/ANSI 51 – 2014 - Food Equipment Materials (Materiali per Attrezzature Alimentari): è stata sviluppata principalmente per le applicazioni commerciali quindi anche bar, ristoranti, cucine di hotel, mense, ecc. Le lastre ceramiche trovano applicazione nelle zone potenzialmente soggette a spruzzi o particelle di cibo (ad esempio alzatine, pareti, tavoli dove i clienti consumano cibi o bevande). Tale certificazione garantisce i più elevati standard di qualità e sicurezza per i consumatori nel caso dei prodotti certificati.

NSF/ANSI 51 – 2014 - Food Equipment Materials certification was developed principally for commercial applications, so also bars, restaurants, hotel kitchens, canteens, etc. The ceramic slabs are applied in areas potentially subject to splashes or small pieces of food (e.g. stands, walls, tables where customers consume food and drink). This certification guarantees the highest quality and safety standard for consumers in the case of certified products.

Die Zertifizierung NSF/ANSI 51 – 2014 - Food Equipment Materials (Lebensmittelechte Materialien) wurde insbesondere für den Einsatz der Materialien in gewerblichen Umgebungen wie Cafés, Restaurants, Großküchen und Kantinen entworfen. Die keramischen Platten kommen in Umgebungen zum Einsatz, die potenziell mit genießbaren Flüssigkeiten oder mit Lebensmittelteilen in Kontakt geraten könnten (wie beispielsweise Wandleisten, Wände oder Tische, an denen Kunden Nahrung oder Getränke verzehren). Diese Zertifizierung gewährleistet höchste Qualitäts- und Sicherheitsstandards für die Verbraucher beim Einsatz von zertifizierten Produkten.

La certification NSF/ANSI 51 - 2014 - « Food Equipment Materials » (Matériaux pour les installations alimentaires) a été principalement développée pour les activités commerciales, y compris les bars, restaurants, cuisines d'hôtel, cantines etc. Les plaques en céramique sont installées dans des zones potentiellement exposées aux éclaboussures de liquides ou d'aliments (par exemple, vaisseliers, murs, tables où les clients consomment des aliments ou des boissons). Cette certification garantit aux consommateurs l'application des normes les plus strictes en matière de qualité et de sécurité pour les produits certifiés.

ITALY



Centro Ceramico
Bologna Italy

U.S.A.



American Society
for Testing and Materials

Certificazioni di prodotto

Certificazioni rilasciate per i materiali Ariostea dai seguenti organismi ufficiali.

Product certifications

Certifications issued for Ariostea materials by the following official bodies.

Produktprüfberichte

Diese prüfberichte sind für die Materialien Ariostea von den folgenden öffentlichen Behörden ausgestellt worden.

Certifications de produit

Certifications délivrées pour les matériaux Ariostea par les organismes officiels suivants.

FRANCE

REVÊTEMENTS DE SOL



UKRAINE



* La liste à jour des matériaux certifiés UPEC est disponible sur le site internet <http://evaluation.cstb.fr>

MARCHIO CE / CE MARK / CE ZEICHEN / MARQUE CE



Indica che i prodotti Ariostea sono conformi a quanto richiesto dal regolamento UE 35/2011, in particolare ai requisiti di protezione e sicurezza per il consumatore e che perciò possono liberamente circolare all'interno del Mercato Comune. Per visualizzare le dichiarazioni di conformità di ogni singolo prodotto Ariostea, consultare il sito <http://marcature-ce.iris-group.it>

It indicates that Ariostea products comply with the requirements of 35/2011 UE directive – in particular with regard to health production and the users and consumers' safety – and may thus be freely circulated on the Community market. For the declarations of conformity of each single product, please refer to <http://marcature-ce.iris-group.it>

Es bedeutet dass die Ariostea Produkte der Europäischen 35/2011 UE in besonderen den Schutz – und Sicherheitsnormen dem Verbraucher gegenüber entsprechen. Aus diesem Grund dürfen sie auf dem ganzen Gemeinsamen Markt frei umlaufen. Konformitätserklärungen finden Sie auf der <http://marcature-ce.iris-group.it>

Cette marque signifie que les produits de Ariostea respectent la Directive UE 35/2011 sur les normes de sûreté et de protection du consommateur et qui peuvent circuler librement dans le Marché Commun. Pour les déclarations de conformité de chaque produit, veuillez visiter le site Internet <http://marcature-ce.iris-group.it>

SAFE SYSTEM

CLASSIFICAZIONE RESISTENZA ALLO SCIVOLAMENTO / SLIP RESISTANCE CLASSIFICATION /
KLASSIFIZIERUNG DER RUTSCHFESTIGKEIT / RÉSISTANCE AU GLISSEMENT



NORMA DIN 51130

R9
6° - 10°

COLLEZIONE /
COLLECTION /
KOLLEKTION /
COLLECTION

FINITURA / FINISH /
OBERFLÄCHEN
AUSFÜHRUNG /
FINITION

DIN 51097

ULTRA MARMI		SO	-
ULTRA IRIDIUM		SO	-
ULTRA ICEMENTI		SO	-
ULTRA PIETRE		SO	-
ULTRA RESINE		SO	-
ULTRA METAL		SO	A
MATERIE HIGH-TECH	CENERE	SO	-
	GESSO	SO	-
	FANGO	SO	-
	SABBIA	SO	-
	LAVA	SO	-
	LIGNITE	SO	-
	GHIACCIO	SO	-
	DIORITE	SO	-
	PELTRO	SO	-
PIETRE NATURALI HIGH-TECH	CREMA EUROPA	SA	-
	PIETRA D'AVOLA	N	A
	PIETRA DI BARGE	SA	-
	PIETRA DI LUSERNA	SA	-
	PIETRA GIALLA	SA	-
	PIETRA PIASENTINA	SA	-
	SILK GEORGETTE	N	A+B
MARMI cento2cento	BIANCO CALACATTA	SO	-
	STATUARIO ALTISSIMO	SO	-
	GRIS DE SAVOIE	SO	-
	GREY MARBLE	SO	-
MARMI CLASSICI	GREY MARBLE	SO	-
	BIANCO CALACATTA	SO	-
	BIANCO COVELANO	SO	-
	CALACATTA LINCOLN	SO	-
	THASSOS	SO	-
	CREMA MARFIL	SO	-
	GRIS DE SAVOIE	SO	-
	ARABESCATO CLASSICO	SO	-
	ONICE PERLATO	SO	-
	PULPIS GREY	SO	-
	STATUARIO CLASSICO	SO	-
	ZEBRINO BIANCO	SO	-
LEGNI HIGH-TECH	ROVERE SABBIA	AN	A
WOODDRAW	ARTIC	AN	-
	ASH	AN	-
	BOARD	AN	-
	POWDER	AN	-
	RUST	AN	-

AS: Antislip
AN: Anticato / Antiqued / Antik / Antique
BA: Bamboo
LL: Levigato e lucidato / Honed and polished / Geschliffen und poliert / Poli et lustré
L: Lucidato
N: Naturale / Natural /

Naturbelassen / Naturel
SA: Satinato / Satin-finish / Satiniert / Satiné
SL: Semilucidato / Semi-polished / Semi-matt / Semi-lustré
SO: Soft
ST: Strutturato / Structured / Strukturiert / Structuré
SK: Levigato Silk

NORMA DIN 51130

R10
10° - 19°

COLLEZIONE /
COLLECTION /
KOLLEKTION /
COLLECTION

FINITURA / FINISH /
OBERFLÄCHEN
AUSFÜHRUNG /
FINITION

DIN 51097

ULTRA TEKNOSTONE		SO	A+B
ULTRA PIETRE		ST	A+B
ULTRA BLEND.HT		SO	-
ULTRA CON.CREA		SO	-
PIETRE cento2cento	ALDWYCH LIMESTONE	SO	-
	GOLBORNE LIMESTONE	SO	-
	STRANMERE LIMESTONE	SO	-
	BLACK ARDESIA	ST	-
CON.CREA.	CLOUD	N	-
	EARTH	N	-
	INK	N	-
	TALC	N	-
	DOVE GREY	N	-
TEKNOSTONE	LIGHT GREY	N	A+B
	PEARL	N	A+B
	SMOKE	N	A+B
	SOFT BLACK	N	A+B
	TAUPE	N	A+B
	TOBACCO	N	A+B
NORTHSTONE	COAL	N	A+B
	DUST	N	A+B
	FOG	N	A+B
	JUTA	N	A+B
	PITCH	N	A+B
MATERIE HIGH-TECH	CENERE	N	A+B
	GESSO	N	A+B
	FANGO	N	A+B
	SABBIA	N	A+B
	LAVA	N	A+B
	LIGNITE	N	A+B
	GHIACCIO	N	A+B
	DIORITE	N	A+B
	PELTRO	N	A+B
PIETRE NATURALI HIGH-TECH	ARDESIA ANTRACITE	SL	A
	BASALTO GRIGIO	SA	A+B+C
	BLACK ARDESIA	SA	-
	BLACK ARDESIA	ST	A+B
	CADAPPA BLACK	SL	A
	LIMRA	SA	A+B
	PIETRA DI BORGOGNA	SA	A+B+C
	PIETRA SINTRA	SL	A
	QUARZITE BIANCA	SL	A
INNOVATIVE SLABS LEGNI HIGH-TECH	QUERCIA TROPICALE	AN	A+B
	QUERCIA PETRAEA	AN	A+B
	QUERCIA BIANCA	AN	A+B
	QUERCIA CANADESE	AN	A+B
	QUERCIA SHABBY	AN	A+B
LEGNI HIGH-TECH	ROVERE ABBAZIA	AN	A
	ROVERE ANTICO	AN	A
	ROVERE BIANCO	AN	A+B+C
	ROVERE CENERE	AN	A+B
	ROVERE CILIEGIO	AN	A+B
	ROVERE CORDA	AN	A
	ROVERE DECAPÉ	AN	A
	ROVERE IMPERO	AN	A
	ROVERE NATURALE	AN	A+B
	ROVERE NOCE	AN	A+B
	ROVERE PROVENZALE	AN	A+B
	ROVERE REALE	AN	A
	ROVERE TUNDRA	AN	A
	ROVERE NERO	AN	A+B

AN: Anticato / Antiqued / Antik / Antique
BA: Bamboo
LL: Levigato e lucidato / Honed and polished / Geschliffen und poliert / Poli et lustré
L: Lucidato
N: Naturale / Natural /

Naturbelassen / Naturel
SA: Satinato / Satin-finish / Satiniert / Satiné
SL: Semilucidato / Semi-polished / Semi-matt / Semi-lustré
SO: Soft
ST: Strutturato / Structured / Strukturiert / Structuré
SK: Levigato Silk

NORMA DIN 51130

R11
19° - 27°

COLLEZIONE /
COLLECTION /
KOLLEKTION /
COLLECTION

FINITURA / FINISH /
OBERFLÄCHEN
AUSFÜHRUNG /
FINITION

DIN 51097

PIETRE NATURALI HIGH-TECH	ARDESIA ANTRACITE	ST	A+B+C
	BASALTO GRIGIO	ST	A+B+C
	CADAPPA BLACK	ST	A+B
	CREMA EUROPA	ST	A+B
	LIMRA	ST	A+B+C
	PIETRA DI BARGE	ST	A+B
	PIETRA DI BORGOGNA	ST	A+B+C
	PIETRA DI LUSERNA	ST	A+B
	PIETRA DI RAGUSA	ST	A+B
	PIETRA GIALLA	ST	A+B
	PIETRA PIASENTINA	ST	A+B
	PIETRA SINTRA	ST	A+B+C
	QUARZITE BIANCA	ST	A+B+C
LEGNI HIGH-TECH	ROVERE BRICCOLA	AN	A+B
	ROVERE GRIGIO	AN	A
	ROVERE MOKA	AN	A+B
CM2 CON.CREA.	CLOUD	AS	-
	EARTH	AS	-
	INK	AS	-
	TALC	AS	-
	DOVE GREY	AS	-
CM2 TEKNOSTONE	LIGHT GREY	AS	A+B
	SMOKE	AS	A+B
	SOFT BLACK	AS	A+B
CM2 - MATERIE HIGH-TECH	FANGO	AS	A+B
	CENERE	AS	A+B
	DIORITE	AS	A+B
	PELTRO	AS	A+B
CM2 - PIETRE NATURALI HIGH-TECH	PIETRA DI RAGUSA	ST	A+B
	PIETRA PIASENTINA	ST	A+B
	BASALTO GRIGIO	ST	A+B+C
	ABSOLUTE BLACK	ST	A+B
	CREMA EUROPA	ST	A+B
CM2 - LEGNI HIGH-TECH	ROVERE SABBIA	AN	A+B
	ROVERE CENERE	AN	A+B
	ROVERE BRICCOLA	AN	A+B
	ROVERE IMPERO	AN	A+B
	ROVERE GRIGIO	AN	A+B
	ROVERE TUNDRA	AN	A+B

NORMA DIN 51130

R12
27° - 35°

COEFFICIENTE DI ATRITO SUPERIORE ALLA NORMA
ABOVE AVERAGE FRICTION COEFFICIENT
ÜBERDURCHSCHNITTLICHER REIBUNGSKOEFFIZIENT
COEFFICIENT DE FROTTEMENT SUPERIEUR A LA NORME

COLLEZIONE /
COLLECTION /
KOLLEKTION /
COLLECTION

FINITURA / FINISH /
OBERFLÄCHEN
AUSFÜHRUNG /
FINITION

DIN 51097

PIETRE NATURALI HIGH-TECH	SILK GEORGETTE	BA	A+B+C
	PIETRA D'AVOLA	BA	A+B+C

n.b.: I valori di resistenza allo scivolamento, coefficiente di attrito statico o dinamico, riportati sul catalogo e nella tabella Safe System sono da ritenersi puramente indicativi e non vincolanti. Ogni eventuale specifica necessità dovrà essere da noi confermata al momento dell'ordine e comunque sempre prima della posa. **nb:** Slip resistance values, coefficient of static or dynamic friction, in the catalog and in the Safe System Table are purely indicative and not binding. Any specific requirements must be confirmed by us at the time of ordering and in any case before installation. **Anm.:** Die Werte für die Rutschfestigkeit, also des statischen oder dynamischen Reibungskoeffizienten, die im Katalog oder in der Tabelle Safe System aufgeführt sind, sind als unverbindliche Richtwerte anzusehen. Alle spezifischen Anforderungen müssen von uns bei der Bestellung und in jedem Fall vor der Verlegung immer bestätigt werden. **n.b.:** Les valeurs de résistance au glissement, le coefficient de frottement statique ou dynamique, indiqués sur le catalogue et sur le tableau Safe System (Système de Sécurité) doivent être considérés comme purement indicatifs et ne sauraient engager notre responsabilité. Toutes les éventuelles spécifications nécessaires devront faire l'objet d'une confirmation de notre part au moment de la commande et en tout état de cause avant la pose.

**GRADO DI VARIAZIONE CROMATICA / DEGREE OF COLOUR CHANGE /
GRAD DER FARBABWEICHUNG / DEGRE DE VARIATION CHROMATIQUE**

ULTRA MARMI

ARABESCATO STATUARIO	V3
AZUL MACAUBAS	V3
BIANCO CALACATTA	V3
BIANCO CARRARA	V2
BIANCO COVELANO	V3
CALACATTA LINCOLN	V3
CALACATTA MACCHIA VECCHIA	V3
CREMA MARFIL	V2
ESTREMOZ	V2
ERAMOSA BROWN	V3
FIOR DI BOSCO	V2
GREY MARBLE	V3
GRIS DE SAVOIE	V3
NERO MARQUINIA	V2
Paonazetto S	V3
PORTE D'OR	V2
PULPIS BROWN	V3
SAHARA NOIR	V3
STATUARIO ALTISSIMO	V3
STATUARIO ULTRA	V3
THASSOS ULTRA	V2
TRAVERTINO NAVONA	V2
TRAVERTINO SANTA CATERINA	V3
ZEBRINO BLACK	V2

ULTRA ONICI

GREEN ONYX VEIN CUT	V4
GREY ONYX VEIN CUT	V4
ONICE BIANCO EXTRA	V4
ONICE BEIGE	V4
ONICE GRIGIO	V4
ONICE PERSIA	V3
ONICE PESCA	V3
ONICE IVORY	V3

ULTRA TEKNOSTONE

LIGHT GREY	V3
TAUPE	V3
TOBACCO	V3
SMOKE	V3

ULTRA METAL

BROWN ZINC	V3
GREY ZINC	V3
BLUE ZINC	V3
BLACK PLATE	V3
GREY PLATE	V3

ULTRA CON.CREA.

CLOUD	V3
DOVE GREY	V3
EARTH	V3
INK	V3
TALC	V3

ULTRA RESINE

SILICIO	V2
CALCE	V2
PIOMBO	V2
EBANO	V2

ULTRA Pietre

BASALTINA ANTRACITE	V2
BASALTINA GREY	V2
BASALTINA MOKA	V2
BASALTINA SAND	V2
BASALTINA WHITE	V2
AZUL BATEIG LIMESTONE	V2
JERUSALEM LIMESTONE	V2
SAN VICENTE LIMESTONE	V2

ULTRA iCementi

BRONZE	V3
GRAPHITE	V3
IRON	V3
IVORY	V3
SILVER	V3

ULTRA BLEND.HT

BL01	V2
BL02	V2
BL03	V2
BL04	V2
BL05	V2

ULTRA IRIDIUM

BIANCO	V1
NERO	V1

TEKNOSTONE

LIGHT GREY	V3
PEARL	V3
TAUPE	V3
TOBACCO	V3
SMOKE	V3
SOFT BLACK	V3

MATERIE HIGH-TECH

CENERE	V3
GESSO	V3
FANGO	V3
SABBIA	V3
LAVA	V3
LIGNITE	V3
GHIACCIO	V3
DIORITE	V3
PELTRO	V3

MARMI cento2cento

BIANCO CALACATTA	V3
BIANCO CARRARA	V2
GREY MARBLE	V3
GREY ONYX VEIN CUT	V4
GRIS DE SAVOIE	V3
NERO MARQUINIA	V2
ONICE IVORY	V3
STATUARIO ALTISSIMO	V3

PIETRE cento2cento

GOLBORNE LIMESTONE	V2
ALDWYCH LIMESTONE	V2
STRANMERE LIMESTONE	V2
BLACK ARDESIA	V2

MARMI CLASSICI

ARABESCATO CLASSICO	V3
BIANCO CARRARA	V3
BIANCO CALACATTA	V3
BIANCO COVELANO	V3
CALACATTA LINCOLN	V3
CREMA MARFIL	V2
GREY MARBLE	V3
GRIS DE SAVOIE	V3
NERO MARQUINIA	V2
ONICE BIANCO EXTRA	V3
ONICE PERLATO	V3
PULPIS GREY	V3
STATUARIO CLASSICO	V3
THASSOS	V1
ZEBRINO BIANCO	V2

CON.CREA.

CLOUD	V3
EARTH	V3
INK	V3
TALC	V3
DOVE GREY	V3

PIETRE NATURALI

HIGH-TECH

ARDESIA ANTRACITE	V2
BASALTO GRIGIO	V3
BLACK ARDESIA	V2
CADAPPA BLACK	V2
CREMA EUROPA	V2
LIMRA	V2
PIETRA D'AVOLA	V2
PIETRA DI BARGE	V3
PIETRA DI BORGOGNA	V4
PIETRA DI LUSERNA	V2
PIETRA DI RAGUSA	V2
PIETRA GIALLA	V3
PIETRA PIASENTINA	V3
PIETRA SINTRA	V2
QUARZITE BIANCA	V2
SILK GEORGETTE	V2

INNOVATIVE SLABS

LEGNI HIGH-TECH

QUERCIA BIANCA	V3
QUERCIA CANADESE	V3
QUERCIA TROPICALE	V3
QUERCIA PETRAEA	V3
QUERCIA SHABBY	V2

NORTHSTONE

COAL	V2
DUST	V2
FOG	V2
JUTA	V2
PITCH	V2

LEGNI HIGH-TECH

ROVERE ABBAZIA	V3
ROVERE ANTICO	V3

ROVERE BIANCO	V2
ROVERE BRICCOLA	V2
ROVERE CENERE	V3
ROVERE CILIEGIO	V3
ROVERE CORDA	V3
ROVERE DECAPÈ	V3
ROVERE GRIGIO	V4
ROVERE IMPERO	V4
ROVERE MOKA	V4
ROVERE NATURALE	V3
ROVERE NERO	V2
ROVERE NOCE	V4
ROVERE PROVENZALE	V3
ROVERE REALE	V4
ROVERE SABBIA	V3
ROVERE TUNDRA	V2

IRIDIUM

BIANCO	V1
NERO	V1

CM2 - CON.CREA.

CLOUD	V3
EARTH	V3
INK	V3
TALC	V3
DOVE GREY	V3

CM2 - TEKNOSTONE

LIGHT GREY	V3
SMOKE	V3
SOFT BLACK	V3

CM2 - MATERIE HIGH-TECH

FANGO	V3
CENERE	V3
DIORITE	V3
PELTRO	V3

CM2 - PIETRE HIGH-TECH

CREMA EUROPA	V2
PIETRA DI RAGUSA	V2
PIETRA PIASENTINA	V3
BASALTO GRIGIO	V3
ABSOLUTE BLACK	V2

CM2 - LEGNI HIGH-TECH

ROVERE SABBIA	V3
ROVERE CENERE	V3
ROVERE BRICCOLA	V2
ROVERE IMPERO	V4
ROVERE GRIGIO	V4
ROVERE TUNDRA	V2

WOODRAW

ARTIC	V3
ASH	V3
BOARD	V4
POWDER	V4
RUST	V4

	V1 LOW PRODOTTO MONOCROMATICO MONOCHROMATIC PRODUCT EINFARBIGES PRODUKT PRODUIT MONOCHROMATIQUE
--	--

	V2 MODERATE PRODOTTO CON LEGGERA VARIAZIONE CROMATICA PRODUCT WITH LIGHT CHROMATIC VARIATION PRODUKT MIT LEICHTER FARBNUANCE PRODUIT À LÉGERE VARIATION CHROMATIQUE
--	--

	V3 HIGH PRODOTTO CON MARCATA VARIAZIONE CROMATICA PRODUCT WITH HIGH SHADE CHROMATIC VARIATION PRODUKT MIT AUSGEPRÄGTER FARBNUANCE PRODUIT À VARIATION CHROMATIQUE ACCENTUÉE
--	--

	V4 EXTREME PRODOTTO CON FORTE VARIAZIONE CROMATICA PRODUCT WITH VERY HIGH SHADE CHROMATIC VARIATION PRODUKT MIT STARKER FARBNUANCE PRODUIT À FORTE VARIATION CHROMATIQUE
--	---

n.b: I valori di resistenza allo scivolamento, coefficiente di attrito statico o dinamico, riportati sul catalogo e nella tabella Safe System sono da ritenersi puramente indicativi e non vincolanti. Ogni eventuale specifica necessità dovrà essere da noi confermata al momento dell'ordine e comunque sempre prima della posa. **nb:** Slip resistance values, coefficient of static or dynamic friction, in the catalog and in the Safe System Table are purely indicative and not binding. Any specific requirements must be confirmed by us at the time of ordering and in any case before installation. **Anm.:** Die Werte für die Rutschfestigkeit, also des statischen oder dynamischen Reibungskoeffizienten, die im Katalog oder in der Tabelle Safe System aufgeführt sind, sind als unverbindliche Richtwerte anzusehen. Alle spezifischen Anforderungen müssen von uns bei der Bestellung und in jedem Fall vor der Verlegung immer bestätigt werden. **n.b.:** Les valeurs de résistance au glissement, le coefficient de frottement statique ou dynamique, indiqués sur le catalogue et sur le tableau Safe System (Système de Sécurité) doivent être considérés comme purement indicatifs et ne sauraient engager notre responsabilité. Toutes les éventuelles spécifications nécessaires devront faire l'objet d'une confirmation de notre part au moment de la commande et en tout état de cause avant la pose.

ULTRA

CODICI E FORMATI /
CODES AND SIZES /
ARTIKELNR. UND FORMATE /
CODES ET FORMATS

SPESORE: /
THICKNESS: /
DICKE: /
ÉPAISSEUR:

▼
6 mm
▲

FINITURA /
FINISH /
OBERFLÄCHEN-
AUSFÜHRUNG /
FINITION

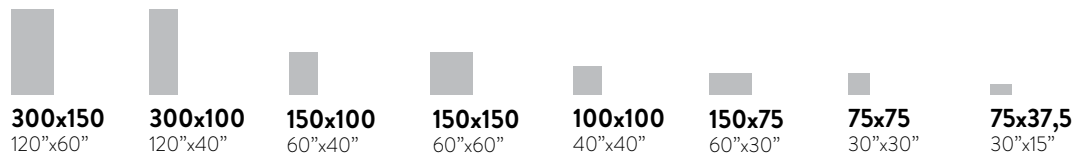

**ULTRA
MARMI**

ARABESCATO	LS	-	-	-	UM6L150479	-	UM6L157479	UM6L75479	UM6L37479
STATUARIO	SO	-	-	-	UM6S150479	-	UM6S157479	UM6S75479	UM6S37479
ARABESCATO	LS	UM6L300479A	-	-	-	-	-	-	-
STATUARIO BLOCK A	SO	UM6S300479A	-	-	-	-	-	-	-
ARABESCATO	LS	UM6L300479B	-	-	-	-	-	-	-
STATUARIO BLOCK B	SO	UM6S300479B	-	-	-	-	-	-	-
AZUL MACAUBAS	LS	UM6L300587	-	-	UM6L150587	-	UM6L157587	UM6L75587	UM6L37587
	SK	UM6SK300587	-	-	UM6SK150587	-	UM6SK157587	UM6SK75587	UM6SK37587
BIANCO CALACATTA	LS	UM6L300536	-	-	UM6L150536	-	UM6L157536	UM6L75536	UM6L37536
	SK	UM6SK300536	-	-	UM6SK150536	-	UM6SK157536	UM6SK75536	UM6SK37536
BIANCO CARRARA	LS	UM6L300555	-	-	UM6L150555	-	UM6L157555	UM6L75555	UM6L37555
	SK	UM6SK300555	-	-	UM6SK150555	-	UM6SK157555	UM6SK75555	UM6SK37555
BIANCO COVELANO	LS	UM6L300480	-	-	UM6L150480	-	UM6L157480	UM6L75480	UM6L37480
	SO	UM6S300480	-	-	UM6S150480	-	UM6S157480	UM6S75480	UM6S37480
CALACATTA LINCOLN	LS	UM6L300523	-	-	UM6L150523	-	UM6L157523	UM6L75523	UM6L37523
CALACATTA	LS	UM6L300575	-	-	UM6L150575	-	UM6L157575	UM6L75575	UM6L37575
MACCHIA VECCHIA	SK	UM6SK300575	-	-	UM6SK150575	-	UM6SK157575	UM6SK75575	UM6SK37575
CALACATTA MACCHIA	LS	UM6L300575A	-	-	-	-	-	-	-
VECCHIA BLOCK A	-	-	-	-	-	-	-	-	-
CALACATTA MACCHIA	LS	UM6L300575B	-	-	-	-	-	-	-
VECCHIA BLOCK B	-	-	-	-	-	-	-	-	-
CREMA	LS	UM6L300304	-	-	UM6L150304	-	UM6L157304	UM6L75304	UM6L37304
MARFIL	SO	UM6S300304	-	-	UM6S150304	-	UM6S157304	UM6S75304	UM6S37304
ERAMOSÁ BROWN	LS	UM6L300469	-	-	UM6L150469	-	UM6L157469	UM6L75469	UM6L37469
ESTREMOZ	LS	UM6L300466	-	-	UM6L150466	-	UM6L157466	UM6L75466	UM6L37466
FIOR DI BOSCO	LS	UM6L300574	-	-	UM6L150574	-	UM6L157574	UM6L75574	UM6L37574
	SK	UM6SK300574	-	-	UM6SK150574	-	UM6SK157574	UM6SK75574	UM6SK37574
GREY MARBLE	LS	UM6L300524	-	-	UM6L150524	-	UM6L157524	UM6L75524	UM6L37524
	SO	UM6S300524	-	-	UM6S150524	-	UM6S157524	UM6S75524	UM6S37524
GRIS DE SAVOIE	LS	UM6L300498	-	-	UM6L150498	-	UM6L157498	UM6L75498	UM6L37498
	SO	UM6S300498	-	-	UM6S150498	-	UM6S157498	UM6S75498	UM6S37498
NERO MARQUINIA	LS	UM6L300547	-	-	UM6L150547	-	UM6L157547	UM6L75547	UM6L37547
	SK	UM6SK300547	-	-	UM6SK150547	-	UM6SK157547	UM6SK75547	UM6SK37547
Paonazzetto S	LS	UM6L300382	-	-	UM6L150382	-	UM6L157382	UM6L75382	UM6L37382
PORTE D'OR	LS	UM6L300525	-	-	UM6L150525	-	UM6L157525	UM6L75525	UM6L37525
PULPIS BROWN	LS	UM6L300526	-	-	UM6L150526	-	UM6L157526	UM6L75526	UM6L37526
SAHARA NOIR	LS	UM6L300585	-	-	UM6L150585	-	UM6L157585	UM6L75585	UM6L37585
	SK	UM6SK300585	-	-	UM6SK150585	-	UM6SK157585	UM6SK75585	UM6SK37585
STATUARIO ALTISSIMO	LS	UM6L300441	-	-	UM6L150441	-	UM6L157441	UM6L75441	UM6L37441
	SO	UM6S300441	-	-	UM6S150441	-	UM6S157441	UM6S75441	UM6S37441
STATUARIO	LS	UM6L300441A	-	-	-	-	-	-	-
ALTISSIMO BLOCK A	SO	UM6S300441A	-	-	-	-	-	-	-
STATUARIO	LS	UM6L300441B	-	-	-	-	-	-	-
ALTISSIMO BLOCK B	SO	UM6S300441B	-	-	-	-	-	-	-
STATUARIO ULTRA	LS	UM6L300260	-	-	UM6L150260	-	UM6L157260	UM6L75260	UM6L37260
	SO	UM6S300260	-	-	UM6S150260	-	UM6S157260	UM6S75260	UM6S37260
STATUARIO	LS	UM6L300260A	-	-	-	-	-	-	-
ULTRA BLOCK A	-	-	-	-	-	-	-	-	-
STATUARIO	LS	UM6L300260B	-	-	-	-	-	-	-
ULTRA BLOCK B	-	-	-	-	-	-	-	-	-
THASSOS	LS	UM6L300318	UM6L310318	UM6L151318	UM6L150318	UM6L100318	UM6L157318	UM6L75318	UM6L37318
	SO	UM6S300318	UM6S310318	UM6S151318	UM6S150318	UM6S100318	UM6S157318	UM6S75318	UM6S37318
TRAVERTINO NAVONA	LS	UM6L300481	-	-	UM6L150481	-	UM6L157481	UM6L75481	UM6L37481
TRAVERTINO	LS	UM6L300431	-	-	UM6L150431	-	UM6L157431	UM6L75431	UM6L37431
SANTA CATERINA	SO	UM6S300431	-	-	UM6S150431	-	UM6S157431	UM6S75431	UM6S37431
ZEBRINO BLACK	LS	UM6L300465	-	-	UM6L150465	-	UM6L157465	UM6L75465	UM6L37465

**ULTRA
iCementi**

BRONZE	SO	UC6S300434	-	-	UC6S150434	-	UC6S157434	UC6S75434	UC6S37434
GRAPHITE	SO	UC6S300421	UC6S310421	UC6S151421	UC6S150421	UC6S100421	UC6S157421	UC6S75421	UC6S37421
IRON	SO	UC6S300422	UC6S310422	UC6S151422	UC6S150422	UC6S100422	UC6S157422	UC6S75422	UC6S37422
IVORY	SO	UC6S300433	-	-	UC6S150433	-	UC6S157433	UC6S75433	UC6S37433
SILVER	SO	UC6S300420	UC6S310420	UC6S151420	UC6S150420	UC6S100420	UC6S157420	UC6S75420	UC6S37420

**ULTRA
PIETRE**

BASALTINA	SO	-	UP6S310442	UP6S151442	-	UP6S100442	-	-	-
ANTRACITE	PRL	-	UP6P310442	-	-	UP6P100442	-	-	-
BASALTINA	SO	-	UP6S310443	UP6S151443	-	UP6S100443	-	-	-
GREY	PRL	-	UP6P310443	-	-	UP6P100443	-	-	-
BASALTINA	SO	-	UP6S310444	UP6S151444	-	UP6S100444	-	-	-
MOKA	PRL	-	UP6P310444	-	-	UP6P100444	-	-	-
BASALTINA	SO	-	UP6S310445	UP6S151445	-	UP6S100445	-	-	-
SAND	PRL	-	UP6P310445	-	-	UP6P100445	-	-	-
BASALTINA	SO	-	UP6S310446	UP6S151446	-	UP6S100446	-	-	-
WHITE	PRL	-	UP6P310446	-	-	UP6P100446	-	-	-
AZUL BATEIG	ST	-	UP6ST310461	UP6ST151461	-	UP6ST100461	-	-	-
LIMESTONE	-	-	-	-	-	-	-	-	-
JERUSALEM	ST	-	UP6ST310462	UP6ST151462	-	UP6ST100462	-	-	-
LIMESTONE	-	-	-	-	-	-	-	-	-
SAN VICENTE	ST	-	UP6ST310463	UP6ST151463	-	UP6ST100463	-	-	-
LIMESTONE	-	-	-	-	-	-	-	-	-

ULTRA

CODICI E FORMATI /
CODES AND SIZES /
ARTIKELNR. UND FORMATE /
CODES ET FORMATS

PRL: Prelucidato **ST:** Structured **SK:** Levigato Silk
SO: Soft **LS:** Lucidato Shiny

SPessore: /
THICKNESS: /
DICKE: /
ÉPAISSEUR:

▼
6 mm
▲

FINITURA /
FINISH /
OBERFLÄCHEN-
AUSFÜHRUNG /
FINITION



300x150
120"x60"



300x100
120"x40"



150x150
60"x60"



150x100
60"x40"



150x75
60"x30"



100x100
40"x40"



75x75
30"x30"



75x37,5
30"x15"

**ULTRA
RESINE**

CALCE	SO	-	UR6S310457	-	UR6S151457	-	UR6S100457	-	-
EBANO	SO	-	UR6S310458	-	UR6S151458	-	UR6S100458	-	-
PIOMBO	SO	-	UR6S310459	-	UR6S151459	-	UR6S100459	-	-
SILICIO	SO	-	UR6S310460	-	UR6S151460	-	UR6S100460	-	-

**ULTRA
ONICI**

BIANCO	LS	UO6L300400	-	UO6L150400	-	UO6L157400	-	UO6L75400	UO6L37400
EXTRA	SO	UO6S300400	-	UO6S150400	-	UO6S157400	-	UO6S75400	UO6S37400
BEIGE	LS	UO6L300401	-	UO6L150401	-	UO6L157401	-	UO6L75401	UO6L37401
GRIGIO	LS	UO6L300411	-	UO6L150411	-	UO6L157411	-	UO6L75411	UO6L37411
	SO	UO6S300411	-	UO6S150411	-	UO6S157411	-	UO6S75411	UO6S37411
ONICE IVORY	LS	UO6L300556	-	UO6L150556	-	UO6L157556	-	UO6L75556	UO6L37556
	SK	UO6SK300556	-	UO6SK150556	-	UO6SK157556	-	UO6SK75556	UO6SK37556
GREEN ONYX	LS	UO6L300558	-	UO6L150558	-	UO6L157558	-	UO6L75558	UO6L37558
VEIN CUT	SK	UO6SK300558	-	UO6SK150558	-	UO6SK157558	-	UO6SK75558	UO6SK37558
GREY ONYX	LS	UO6L300557	-	UO6L150557	-	UO6L157557	-	UO6L75557	UO6L37557
VEIN CUT	SK	UO6SK300557	-	UO6SK150557	-	UO6SK157557	-	UO6SK75557	UO6SK37557
ONICE PERSIA	LS	UO6L300589	-	UO6L150589	-	UO6L157589	-	UO6L75589	UO6L37589
ONICE PERSIA BLOCK A	LS	UO6L300589A	-	-	-	-	-	-	-
ONICE PERSIA BLOCK B	LS	UO6L300589B	-	-	-	-	-	-	-
ONICE PESCA	LS	UO6L300588	-	UO6L150588	-	UO6L157588	-	UO6L75588	UO6L37588

**ULTRA
TEKNOSTONE**

TAUPE	SO	-	UTK6S310507	-	-	-	UTK6S100507	-	-
TOBACCO	SO	-	UTK6S310508	-	-	-	UTK6S100508	-	-
LIGHT GREY	SO	-	UTK6S310503	-	-	-	UTK6S100503	-	-
SMOKE	SO	-	UTK6S310505	-	-	-	UTK6S100505	-	-

**ULTRA
IRIDIUM**

BIANCO	LS	UI6L300353	UI6L310353	UI6L150353	UI6L151353	UI6L157353	UI6L100353	UI6L75353	-
	SO	UI6S300353	UI6S310353	UI6S150353	UI6S151353	UI6S157353	UI6S100353	UI6S75353	-
NERO	LS	UI6L300357	UI6L310357	UI6L150357	UI6L151357	UI6L157357	UI6L100357	UI6L75357	-
	SO	UI6S300357	UI6S310357	UI6S150357	UI6S151357	UI6S157357	UI6S100357	UI6S75357	-

**ULTRA
METAL**

BLUE ZINC	SO	UMT6S300499	UMT6S310499	UMT6S150499	UMT6S151499	UMT6S157499	UMT6S100499	UMT6S75499	UMT6S37499
BROWN ZINC	SO	UMT6S300500	UMT6S310500	UMT6S150500	UMT6S151500	UMT6S157500	UMT6S100500	UMT6S75500	UMT6S37500
GREY ZINC	SO	UMT6S300501	UMT6S310501	UMT6S150501	UMT6S151501	UMT6S157501	UMT6S100501	UMT6S75501	UMT6S37501
BLACK PLATE	SO	UMT6S300577	-	UMT6S150577	-	UMT6S157577	-	UMT6S75577	UMT6S37577
GREY PLATE	SO	UMT6S300578	-	UMT6S150578	-	UMT6S157578	-	UMT6S75578	UMT6S37578

**ULTRA
CON.CREA**

CLOUD	SO	UCC6S300562	UCC6S310562	UCC6S150562	UCC6S151562	UCC6S157562	UCC6S100562	UCC6S75562	UCC6S37562
DOVE GREY	SO	UCC6S300576	UCC6S310576	UCC6S150576	UCC6S151576	UCC6S157576	UCC6S100576	UCC6S75576	UCC6S37576
EARTH	SO	UCC6S300563	UCC6S310563	UCC6S150563	UCC6S151563	UCC6S157563	UCC6S100563	UCC6S75563	UCC6S37563
INK	SO	UCC6S300564	UCC6S310564	UCC6S150564	UCC6S151564	UCC6S157564	UCC6S100564	UCC6S75564	UCC6S37564
TALC	SO	UCC6S300565	UCC6S310565	UCC6S150565	UCC6S151565	UCC6S157565	UCC6S100565	UCC6S75565	UCC6S37565

**ULTRA
BLEND.HT**

BL01	SO	-	-	-	-	-	UBD6S100569	-	-
	SK	-	-	-	-	-	UBD6SK100569	-	-
BL02	SO	-	-	-	-	-	UBD6S100570	-	-
	SK	-	-	-	-	-	UBD6SK100570	-	-
BL03	SO	-	-	-	-	-	UBD6S100571	-	-
	SK	-	-	-	-	-	UBD6SK100571	-	-
BL04	SO	-	-	-	-	-	UBD6S100572	-	-
	SK	-	-	-	-	-	UBD6SK100572	-	-
BL05	SO	-	-	-	-	-	UBD6S100573	-	-
	SK	-	-	-	-	-	UBD6SK100573	-	-

IMBALLAGGI E PESI / PACKING AND WEIGHTS / VERPACKUNG UND GEWICHT / EMBALLAGES ET POIDS

FORMATI E SPESSORI/
SIZES AND THICKNESS/
FORMATE UND STÄRKE/
FORMATS ET ÉPAISSEUR

	300 x 150 cm 6 mm	300 x 100 cm 6 mm	150 x 150 cm 6 mm	150 x 100 cm 6 mm	100 x 100 cm 6 mm	150 x 75 cm 6 mm	75 x 75 cm 6 mm	75 x 37,5 cm 6 mm
Collezione / Collection / Kollektion / Collection	Ultra Marmi Ultra Iridium Ultra iCementi Ultra Onici Ultra Metal Ultra Con.Crea.	Ultra Marmi Ultra Teknostone Ultra Pietre Ultra Iridium Ultra iCementi Ultra Resine Ultra Metal Ultra Con.Crea.	Ultra Marmi Ultra Iridium Ultra iCementi Ultra Onici Ultra Metal Ultra Con.Crea.	Ultra Marmi Ultra Iridium Ultra iCementi Ultra Pietre Ultra Metal Ultra Con.Crea.	Ultra Marmi Ultra Iridium Ultra iCementi Ultra Resine Ultra Pietre Ultra Metal Ultra Con.Crea.	Ultra Marmi Ultra Iridium Ultra Teknostone Ultra iCementi Ultra Resine Ultra Pietre Ultra Metal Ultra Con.Crea. Ultra Blend.HT	Ultra Marmi Ultra Iridium Ultra iCementi Ultra Onici Ultra Metal Ultra Con.Crea.	Ultra Marmi Ultra Iridium Ultra iCementi Ultra Onici Ultra Metal Ultra Con.Crea.
Finitura / Finish / Oberflächenausführung / Finition	LS / SK / SO	LS / SO / ST / PRL	LS / SK / SO	LS / SO / ST	LS / SO / ST / PRL	LS / SK / SO	LS / SK / SO	LS / SK / SO
Pezzi Scatola / Pieces box / Stücke karton / Pièces boîte	1	1	1	1	2	2	3	6
Mq. Scatola / Sq. Mt. Box / Qm. Karton / m² boîte	4,50	3,00	2,25	1,50	2,00	2,25	1,688	1,688
Peso Scatola / Weight box / Gewicht karton / Poids boîte	63,32	42,20	31,66	21,11	28,15	31,66	23,75	23,75
Peso mq. / Sq. Mt. Weight / Qm. Gewicht / Poids m²	14,07	14,07	14,07	14,07	14,07	14,07	14,07	14,07
Scatole Pallet / Box Pallet / Karton Palette / Boîte Palette	12	16	24	40	26	26	38	44
Mq. Pallet / Sq. Mt. Pallet / Qm. Palette / m² Palette	54,00	48,00	54,00	60,00	52,00	58,50	64,13	74,25
Peso Pallet / Weight Pallet / Gewicht Palette / Poids Palette	760,00	680,00	760,00	916,00	786,00	882,00	960,00	1103,00



328 x 154
129"x60"

FINITURA /
FINISH /
OBERFLÄCHENAUSFÜHRUNG /
FINITION

SPESORE: /
THICKNESS: /
DICKE: /
ÉPAISSEUR:

12 mm

SPESORE: /
THICKNESS: /
DICKE: /
ÉPAISSEUR:

20 mm

IMBALLAGGI E PESI / PACKING AND WEIGHTS /
VERPACKUNG UND GEWICHT / EMBALLAGES ET POIDS

	ARABESCATO	NATURAL	SSH3215511GST	-
		POLISHED	SSP3215511GST	-
	BIANCO LASA	NATURAL	SSH3215508GST	-
		POLISHED	SSP3215508GST	-
	CALACATTA STATUARIO	NATURAL	SSH3215507GST	-
		POLISHED	SSP3215507GST	-
	CALACATTA STATUARIO BLOCK A	SILKY	SSH3215507GST	-
		POLISHED	SSP3215507GST	-
	CALACATTA STATUARIO BLOCK B	SILKY	SSY3215601GST	-
		POLISHED	SSP3215601GST	-
	DARK MARQUINA	SILKY	SSY3215523GST	-
		POLISHED	SSP3215523GST	-
	UNI ICE	NATURAL	SSH3215505GST	SSH3215505G20
		POLISHED	SSP3215505GST	-
	WHITE CALACATTA BLOCK A	SILKY	SSY3215522GST	-
		POLISHED	SSP3215522GST	-
	WHITE CALACATTA BLOCK B	SILKY	SSY3215600GST	-
		POLISHED	SSP3215600GST	-
	BASALT BLACK	NATURAL	SSH3215501G	-
				-
	BASALT CREAM	NATURAL	SSH3215502G	-
				-
	URBAN ANTRACITE	NATURAL	SSH3215504G	-
				-
	URBAN ARGENTO	NATURAL	SSH3215503G	-
				-
	BROWN EARTH	NATURAL	SSH3215521G	-
				-
	GREY EARTH	NATURAL	SSH3215520G	-
				-
	LIGHT EARTH	NATURAL	SSH3215519G	-
				-
	SAND EARTH	NATURAL	SSH3215518G	-
				-
	MALM BLACK	NATURAL	SSH3215510G	-
		PRE-POLISHED	SSP3215510G	-
	MALM GREY	NATURAL	SSH3215509G	-
		PRE-POLISHED	SSP3215509G	-
	ROVERE BAIO	NATURAL	SSH3215524G	-
				-
	ROVERE BUCKSKIN	NATURAL	SSH3215525G	-
				-

Collezione / Collection / Kollektion / Collection	Ultra / Sapienstone	Ultra / Sapienstone
Finitura / Finish / Oberflächenausführung / Finition	NATURAL POLISHED PRE-POLISHED SILKY	NATURAL POLISHED PRE-POLISHED SILKY
Pezzi Scatola / Pieces box / Stücke karton / Pièces boîte	1	1
Mq. Scatola / Sq. Mt. Box / Qm. Karton / m² boîte	5,0512	5,0512
Peso Scatola / Weight box / Gewicht karton / Poids boîte	156,5872 Kg	156,5872 Kg
Peso mq. / Sq. Mt. Weight / Qm. Gewicht / Poids m²	31,0 Kg	31,0 Kg
Scatole Pallet / Box Pallet / Karton Palette / Boîte Palette	22	12
Mq. Pallet / Sq. Mt. Pallet / Qm. Palette / m² Palette	111,1264	60,6144
Peso Pallet / Weight Pallet / Gewicht Palette / Poids Palette	3480,0 Kg	2068,0 Kg

GRADO DI VARIAZIONE CROMATICA / DEGREE OF COLOUR CHANGE /
GRAD DER FARBABWEICHUNG / DEGRE DE VARIATION CHROMATIQUE

ULTRA / SAPIENSTONE

ARABESCATO	V3
BIANCO LASA	V3
CALACATTA STATUARIO	V3
DARK MARQUINA	V2
UNI ICE	V1
WHITE CALACATTA	V3
BASALT BLACK	V2
BASALT CREAM	V2
URBAN ANTRACITE	V2
URBAN ARGENTO	V2
BROWN EARTH	V3
GREY EARTH	V3
LIGHT EARTH	V3
SAND EARTH	V3
MALM BLACK	V3
MALM GREY	V3
ROVERE BAIO	V3
ROVERE BUCKSKIN	V3



V1 LOW
PRODOTTO MONOCROMATICO
MONOCHROMATIC PRODUCT
EINFARBIGES PRODUKT
PRODUIT MONOCHROMATIQUE



V2 MODERATE
PRODOTTO CON LEGGERA VARIAZIONE CROMATICA
PRODUCT WITH LIGHT CHROMATIC VARIATION
PRODUKT MIT LEICHTER FARBNUANCE
PRODUIT À LÉGERE VARIATION CHROMATIQUE



V3 HIGH
PRODOTTO CON MARCATA VARIAZIONE CROMATICA
PRODUCT WITH HIGH SHADE CHROMATIC VARIATION
PRODUKT MIT AUSGEPRAEGTER FARBNUANCE
PRODUIT À VARIATION CHROMATIQUE ACCENTUÉE



V4 EXTREME
PRODOTTO CON FORTE VARIAZIONE CROMATICA
PRODUCT WITH VERY HIGH SHADE CHROMATIC VARIATION
PRODUKT MIT STARKER FARBNUANCE
PRODUIT À FORTE VARIATION CHROMATIQUE

MARMI cento2cento

CODICI E FORMATI /
CODES AND SIZES /
ARTIKELNR. UND FORMATE /
CODES ET FORMATS

SPESORE: /
THICKNESS: /
DICKE: /
ÉPAISSEUR:

9mm

FINITURA /
FINISH /
OBERFLÄCHEN
AUSFÜHRUNG /
FINITION

200x100
80"x40"

100x100
40"x40"

BIANCO CARRARA	L	UM9L200555	UM9L100555
	SK	UM9SK200555	UM9SK100555
NERO MARQUINIA	L	UM9L200547	UM9L100547
	SK	UM9SK200547	UM9SK100547
ONICE IVORY	L	UM9L200556	UM9L100556
	SK	UM9SK200556	UM9SK100556
GREY ONYX VEIN CUT	L	UM9L200557	UM9L100557
	SK	UM9SK200557	UM9SK100557
BIANCO CALACATTA	L	UM9L200527	UM9L100527
	SO	UM9S200527	UM9S100527
GREY MARBLE	L	UM9L200524	UM9L100524
	SO	UM9S200524	UM9S100524
GRIS DE SAVOIE	L	UM9L200498	UM9L100498
	SO	UM9S200498	UM9S100498
STATUARIO ALTISSIMO	L	UM9L200441	UM9L100441
	SO	UM9S200441	UM9S100441

AN: Anticato / Antiqued /
Antik / Antique
AS: Antislip
L: Lucidato
N: Naturale / Natural /
Naturbelassen / Naturel

SO: Soft
SK: Levigato Silk
ST: Structured

MARMI CLASSICI

CODICI E FORMATI /
CODES AND SIZES /
ARTIKELNR. UND FORMATE /
CODES ET FORMATS

SPESORE: /
THICKNESS: /
DICKE: /
ÉPAISSEUR:

8 mm

FINITURA /
FINISH /
OBERFLÄCHEN
AUSFÜHRUNG /
FINITION

120x60
48"x24"

60x60
24"x24"

60x30
24"x12"

60x6,5
24"x2^{1/2}"

60x30
24"x12"

ARABESCATO CLASSICO	L	PL612513	PL6513	PL360513	BL60513AN	GL6513R1
	SO	P612513	P6513	P360513	B60513T	GR6513R1
BIANCO CALACATTA	L	PL612527	PL6527	PL360527	BL60527AN	GL6527R1
	SO	P612527	P6527	P360527	B60527T	GR6527R1
BIANCO CARRARA	L	PL612555	PL6555	PL360555	BL60555AN	GL6555R1
	SK	PK612555	PK6555	PK360555	BK60555T	GK6555R1
BIANCO COVELANO	L	PL612480	PL6480	PL360480	BL60480AN	GL6480R1
	SO	P612480	P6480	P360480	B60480T	GR6480R1
CALACATTA LINCOLN	L	PL612523	PL6523	PL360523	BL60523AN	GL6523R1
	SO	P612523	P6523	P360523	B60523T	GR6523R1
CREMA MARFIL	L	PL612548	PL6548	PL360548	BL60548AN	GL6548R1
	SO	P612548	P6548	P360548	B60548T	GR6548R1
GRIS DE SAVOIE	L	PL612498	PL6498	PL360498	BL60498AN	GL6498R1
	SO	P612498	P6498	P360498	B60498T	GR6498R1
GREY MARBLE	L	PL612528	PL6528	PL360528	BL60528AN	GL6528R1
	SO	P612528	P6528	P360528	B60528T	GR6528R1
NERO MARQUINIA	L	PL612547	PL6547	PL360547	BL60547AN	GL6547R1
	SK	PK612547	PK6547	PK360547	BK60547T	GK6547R1
ONICE BIANCO EXTRA	L	PL612400	PL6400	PL360400	BL60400AN	GL6400R1
	SK	PK612400	PK6400	PK360400	BK60400T	GK6400R1
ONICE PERLATO	L	PL612514	PL6514	PL360514	BL60514AN	GL6514R1
	SO	P612514	P6514	P360514	B60514T	GR6514R1
PULPIS GREY	L	PL612515	PL6515	PL360515	BL60515AN	GL6515R1
	SO	P612515	P6515	P360515	B60515T	GR6515R1
STATUARIO CLASSICO	L	PL612516	PL6516	PL360516	BL60516AN	GL6516R1
	SO	P612516	P6516	P360516	B60516T	GR6516R1
THASSOS	L	PL612554	PL6554	PL360554	BL60554AN	GL6554R1
	SO	P612554	P6554	P360554	B60554T	GR6554R1
ZEBRINO BIANCO	L	PL612517	PL6517	PL360517	BL60517AN	GL6517R1
	SO	P612517	P6517	P360517	B60517T	GR6517R1

BATTISCOPA /
BULLNOSE /
STEHSOCKEL /
PLINTHE

GRADINO CLASSICO /
STEP TREAD /
STUFENPLATTE /
NEZ DE MARCHE

PIETRE cento2cento

CODICI E FORMATI /
CODES AND SIZES /
ARTIKELNR. UND FORMATE /
CODES ET FORMATS

FINITURA /
FINISH /
OBERFLÄCHEN
AUSFÜHRUNG /
FINITION

SPESORE: /
THICKNESS: /
DICKE: /
ÉPAISSEUR:

200x100
80"x40"

100x100
40"x40"

GOLBORNE LIMESTONE	SO	9mm	UP9S200580	UP9S100580
	SO	6mm	-	P100580
ALDWYCH LIMESTONE	SO	9mm	UP9S200579	UP9S100579
	SO	6mm	-	P100579
STRANMERE LIMESTONE	SO	9mm	UP9S200581	UP9S100581
	SO	6mm	-	P100581
BLACK ARDESIA	SO	9mm	-	-
	ST	6mm	-	PS100277

CONCREA

CODICI E FORMATI /
CODES AND SIZES /
ARTIKELNR. UND FORMATE /
CODES ET FORMATS

SPESORE: /
THICKNESS: /
DICKE: /
ÉPAISSEUR:

9 mm

FINITURA /
FINISH /
OBERFLÄCHEN
AUSFÜHRUNG /
FINITION

120x60
48"x24"

60x60
24"x24"

60x30
24"x12"

60x6,5
24"x2^{1/2}"

60x30
24"x12"

CLOUD	N	P612562	P6562	P360562	B60562T	GR6562R1
	AS	PAS612562	PAS6562	PAS360562	-	GA6562R1
	PRL	PP612562	PP6562	PP360562	BP60562T	-
EARTH	N	P612563	P6563	P360563	B60563T	GR6563R1
	AS	PAS612563	PAS6563	PAS360563	-	GA6563R1
	PRL	PP612563	PP6563	PP360563	BP60563T	-
INK	N	P612564	P6564	P360564	B60564T	GR6564R1
	AS	PAS612564	PAS6564	PAS360564	-	GA6564R1
	PRL	PP612564	PP6564	PP360564	BP60564T	-
TALC	N	P612565	P6565	P360565	B60565T	GR6565R1
	AS	PAS612565	PAS6565	PAS360565	-	GA6565R1
	PRL	PP612565	PP6565	PP360565	BP60565T	-
DOVE GREY	N	P612576	P6576	P360576	B60576T	GR6576R1
	AS	PAS612576	PAS6576	PAS360576	-	GA6576R1
	PRL	PP612576	PP6576	PP360576	BP60576T	-







BATTISCOPA /
BULLNOSE /
STEHSOCKEL /
PLINTHE





GRADINO CLASSICO /
STEP TREAD /
STUFENPLATTE /
NEZ DE MARCHE

TEKNOSTONE

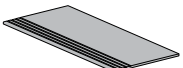

CODICI E FORMATI /
CODES AND SIZES /
ARTIKELNR. UND FORMATE /
CODES ET FORMATS

AS: Antislip
SK: Levigato Silk
N: Naturale / Natural / Naturbelassen / Naturel

SPESSORE: / THICKNESS: / DICKE: / ÉPAISSEUR:	FINITURA / FINISH / OBERFLÄCHENAUSFÜHRUNG / FINITION	 8mm	 150x75 60"x30" 6mm	 75x75 30"x30" 6mm	 120x60 48"x24" 8mm	 60x60 24"x24" 8mm	 60x30 24"x12" 8mm
		LIGHT GREY	N	P150503S6	P75503S6	P612503	P6503
PEARL	N	P150504S6	P75504S6	P612504	P6504	P360504	
SMOKE	N	P150505S6	P75505S6	P612505	P6505	P360505	
SOFT BLACK	N	P150506S6	P75506S6	P612506	P6506	P360506	
TAUPE	N	P150507S6	P75507S6	P612507	P6507	P360507	
TOBACCO	N	P150508S6	P75508S6	P612508	P6508	P360508	

PEZZI SPECIALI TRIMS / FORMTEILE / PIÈCES SPÉCIALES	FINITURA / FINISH / OBERFLÄCHENAUSFÜHRUNG / FINITION	GRADINO CLASSICO / STEP TREAD / STUFENPLATTE / NEZ DE MARCHÉ	BATTISCOPA / BULLNOSE / STEHSOCKEL / PLINTHE	MOSAICI BLITZ	MODULO RANDOM
		 60x30 24"x12" 8mm	 75x6,5 30x2 ^{1/2} " 6mm	 30x30 12"x12"	 60x30 24"x12"
LIGHT GREY	N	GR6503R1	B75503T	B60503T	BLIN503
PEARL	N	GR6504R1	B75504T	B60504T	BLIN504
SMOKE	N	GR6505R1	B75505T	B60505T	BLIN505
SOFT BLACK	N	GR6506R1	B75506T	B60506T	BLIN506
TAUPE	N	GR6507R1	B75507T	B60507T	BLIN507
TOBACCO	N	GR6508R1	B75508T	B60508T	BLIN508

SPESSORE: / THICKNESS: / DICKE: / ÉPAISSEUR:	FINITURA / FINISH / OBERFLÄCHENAUSFÜHRUNG / FINITION	 20mm	GRADONE BECCO CM2 STEP TREAD WITH HALF BULLNOSE EDGE / STUFENPLATTE MIT ABGERUNDETER KANTE / NEZ DE MARCHÉ AVEC BORD ARRONDI	GRADONE TORO CM2 STEP TREAD GRADONE TORO CM2 / STUFENPLATTE GRADONE TORO CM2 / NEZ DE MARCHÉ ÉPAISSEUR 2CM	GRIGLIA CM2 WATER GRATE / ABDECKPLATTE WASSERABLAUF / GRILLE
		PEZZI SPECIALI TRIMS / FORMTEILE / PIÈCES SPÉCIALES	 60x30 24"x12"	 60x30 24"x12"	 60x15 24"x6"
LIGHT GREY	AS	PMS612503	PMS60503	GMS6503B1	GMST6503
SMOKE	AS	PMS612505	PMS60505	GMS6505B1	GMST6505
SOFT BLACK	AS	PMS612506	PMS60506	GMS6506B1	GMST6506

NORTHSTONE	CODICI E FORMATI / CODES AND SIZES / ARTIKELNR. UND FORMATE / CODES ET FORMATS	SPESSORE: / THICKNESS: / DICKE: / ÉPAISSEUR:	FINITURA / FINISH / OBERFLÄCHENAUSFÜHRUNG / FINITION	 9 mm	GRADINO CLASSICO / STEP TREAD / STUFENPLATTE / NEZ DE MARCHÉ	BATTISCOPA / BULLNOSE / STEHSOCKEL / PLINTHE	
				PEZZI SPECIALI TRIMS / FORMTEILE / PIÈCES SPÉCIALES	 60x30 24"x12"	 60x6,5 24x2 ^{1/2} "	
COAL	SK	PK612549	PK6549	PK360549	SK	GK6549R1	BK60549T
DUST	SK	PK612550	PK6550	PK360550	N	GR6549R1	B60549T
FOG	SK	PK612551	PK6551	PK360551	SK	GK6550R1	BK60550T
JUTA	SK	PK612552	PK6552	PK360552	N	GR6550R1	B60550T
PITCH	SK	PK612553	PK6553	PK360553	SK	GK6551R1	BK60551T
	N	P612551	P6551	P360551	N	GR6551R1	B60551T
	SK	PK612552	PK6552	PK360552	SK	GK6552R1	BK60552T
	N	P612552	P6552	P360552	N	GR6552R1	B60552T
	SK	PK612553	PK6553	PK360553	SK	GK6553R1	BK60553T
	N	P612553	P6553	P360553	N	GR6553R1	B60553T

MATERIE HIGH-TECH

CODICI E FORMATI /
CODES AND SIZES /
ARTIKELNR. UND FORMATE /
CODES ET FORMATS

AS: Antislip
N: Naturale / Natural / Naturbelassen / Naturel
SO: Soft

SPESORE: / THICKNESS: / DICKE: / ÉPAISSEUR: **6mm**

FINITURA / FINISH / OBERFLÄCHENAUFÜHRUNG / FINITION

150x75
60"x30"

75x75
30"x30"

PEZZI SPECIALI TRIMS / FORMTEILE / PIÈCES SPÉCIALES

BATTISCOPA / BULLNOSE / STEHSCOCKEL / PLINTHE

75x6,5
30x2^{1/2"}

CENERE	SO	PS150452S6	PS75452S6
FANGO	SO	PS150453S6	PS75453S6
GESSO	SO	PS150454S6	PS75454S6
SABBIA	SO	PS150456S6	PS75456S6

BS6452T
BS6453T
BS6454T
BS6456T

SPESORE: / THICKNESS: / DICKE: / ÉPAISSEUR: **10mm**

FINITURA / FINISH / OBERFLÄCHENAUFÜHRUNG / FINITION

120x60
48"x24"

60x60
24"x24"

60x30
24"x12"

PEZZI SPECIALI TRIMS / FORMTEILE / PIÈCES SPÉCIALES

GRADINO CLASSICO / STEP TREAD / STUFENPLATTE / NEZ DE MARCHÉ

BATTISCOPA / BULLNOSE / STEHSCOCKEL / PLINTHE

GRADONE COSTA RETTA / COSTA RETTA STEP TREAD / STUFE COSTA RETTA / NEZ DE MARCHÉ COSTA RETTA

ANGOLARE COSTA RETTA / COSTA RETTA STEP TREAD CORNER / ECKSTUFE COSTA RETTA / NEZ DE MARCHÉ COSTA RETTA AVEC ANGLE

60x30
24"x12"

60x9
24x3^{3/5"}

120x34
48x13^{1/2"}

120x34
48x13^{1/2"}

CENERE	SO	PS612452	PS6452	PS36452
	N	P612452	P6452	P36452
FANGO	SO	PS612453	PS6453	PS36453
	N	P612453	P6453	P36453
GESSO	SO	PS612454	PS6454	PS36454
	N	P612454	P6454	P36454
LAVA	SO	PS612455	PS6455	PS36455
	N	P612455	P6455	P36455
SABBIA	SO	PS612456	PS6456	PS36456
	N	P612456	P6456	P36456
LIGNITE	SO	PS612473	PS6473	PS36473
	N	P612473	P6473	P36473
GHIACCIO	SO	PS612474	PS6474	PS36474
	N	P612474	P6474	P36474
DIORITE	SO	PS612475	PS6475	PS36475
	N	P612475	P6475	P36475
PELTRO	SO	PS612476	PS6476	PS36476
	N	P612476	P6476	P36476

GS6452R1	BS9452T	PGRST12452	PRAST12452
GR6452R1	-	-	-
GS6453R1	BS9453T	PGRST12453	PRAST12453
GR6453R1	-	-	-
GS6454R1	BS9454T	PGRST12454	PRAST12454
GR6454R1	-	-	-
GS6455R1	BS9455T	PGRST12455	PRAST12455
GR6455R1	-	-	-
GS6456R1	BS9456T	PGRST12456	PRAST12456
GR6456R1	-	-	-
GS6473R1	BS9473T	PGRST12473	PRAST12473
GR6473R1	-	-	-
GS6474R1	BS9474T	PGRST12474	PRAST12474
GR6474R1	-	-	-
GS6475R1	BS9475T	PGRST12475	PRAST12475
GR6475R1	-	-	-
GS6476R1	BS9476T	PGRST12476	PRAST12476
GR6476R1	-	-	-

SPESORE: / THICKNESS: / DICKE: / ÉPAISSEUR: **20mm**

FINITURA / FINISH / OBERFLÄCHENAUFÜHRUNG / FINITION

120x60
48"x24"

60x60
24"x24"

PEZZI SPECIALI TRIMS / FORMTEILE / PIÈCES SPÉCIALES

GRADONE BECCO CM2 / STEPTREAD WITH HALF BULLNOSE EDGE / STUFENPLATTE MIT ABGERUNDETER KANTE / NEZ DE MARCHÉ AVEC BORD ARRONDI

GRADONE TORO CM2 / STEPTREAD GRADONE TORO CM2 / STUFENPLATTE GRADONE TORO CM2 / NEZ DE MARCHÉ ÉPAISSEUR 2CM

GRIGLIA CM2 / WATER GRATE / ABDECKPLATTE WASSERABLAUF / GRILLE

60x30
24"x12"

60x30
24"x12"

60x15
24"x6"

CENERE	AS	PMS612452	PMS60452
FANGO	AS	PMS612453	PMS60453
DIORITE	AS	PMS612475	PMS60475
PELTRO	AS	PMS612476	PMS60476

GMS6452B1	GMST6452	GRIGLIA452
GMS6453B1	GMST6453	GRIGLIA453
GMS6475B1	GMST6475	GRIGLIA475
GMS6476B1	GMST6476	GRIGLIA476

PIETRE NATURALI HIGH-TECH

CODICI E FORMATI /
CODES AND SIZES /
ARTIKELNR. UND FORMATE /
CODES ET FORMATS

ST: Strutturato / Structured / Strukturiert / Structuré
BA: Bamboo
SA: Satinato / Satin-finish / Satiniert / Satiné

SL: Semilucidato / Semi-polished / Semi-matt / Semi-lustré
L: Lucidato
N: Naturale / Natural / Naturbelassen / Naturel

PEZZI SPECIALI / TRIMS / FORMTEILE / PIÈCES SPÉCIALES

BATTISCOPA /
BULLNOSE /
STEHSOCKEL /
PLINTHE

ELEMENTO A "L" /
"L" ELEMENT /
SCHENKEL /
ELEMENT EN "L"

ELEMENTO A "L" COSTA RETTA /
COSTA RETTA "L" ELEMENT /
LÄNGSSCHENKEL
COSTA RETTA /
ELEMENT EN "L" COSTA RETTA

GRADINO CLASSICO /
STEP TREAD /
STUFENPLATTE /
NEZ DE MARCHÉ

SPESORE: /
THICKNESS: /
DICKE: /
ÉPAISSEUR:

10mm

FINITURA /
FINISH /
OBERFLÄCHEN-
AUSFÜHRUNG /
FINITION

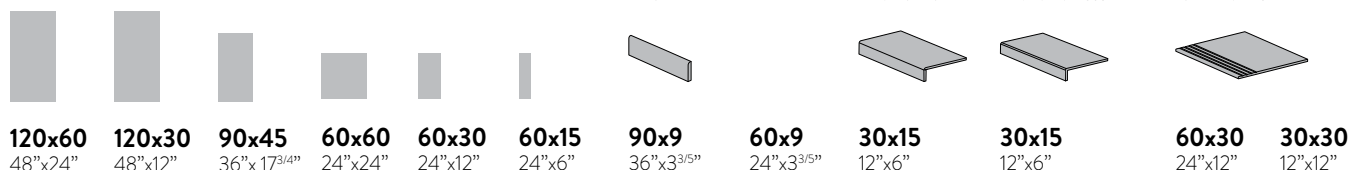

ARDESIA ANTRACITE	SL	P612390	-	-	P6390	P36390	P615390	-	-	B9390T	-	-	-	GR6390R1	-
	ST	PS612390	-	-	PS6390	PS36390	PS615390	-	-	BS9390T	-	-	-	GS6390R1	-
BASALTO GRIGIO	ST	-	-	-	PS6330	PS36330	PS615330	-	-	BS9330T	PEL15330	-	-	GS6330R1	GS3330R1
	SA	P612330	-	-	P6330	P36330	P615330	-	-	B9330T	-	-	-	GR6330R1	GR3330R1
BLACK ARDESIA	ST	PS612277	-	PS49277	PS6277	PS36277	PS615277M	BS90277T	BS9277T	PEL15277	PELR15277	-	-	GS6277R1	GS3277R1
	SA	-	-	P49277	P6277	P36277	P615277	B90277T	B9277T	-	-	-	-	GR6277R1	GR3277R1
CADAPPA BLACK	SL	P612391	-	-	P6391	P36391	P615391	-	-	B9391T	-	-	-	GR6391R1	-
	ST	PS612391	-	-	PS6391	PS36391	PS615391	-	-	BS9391T	-	-	-	GS6391R1	-
CREMA EUROPA	ST	PS612296	-	PS49296	PS6296	PS36296	PS615296	BS90296T	BS9296T	PEL15296	PELR15296	-	-	GS6296R1	GS3296R1
	SA	-	-	P49296	P6296	P36296	P615296	B90296T	B9296T	-	-	-	-	GR6296R1	GR3296R1
LIMRA	ST	-	-	-	PS6331	PS36331	PS615331	-	-	BS9331T	PEL15331	-	-	GS6331R1	GS3331R1
	SA	P612331	-	P49331	P6331	P36331	P615331	-	-	B9331T	-	-	-	GR6331R1	GR3331R1
PIETRA D'AVOLA	N	P612428	P120428	-	P6428	P36428	-	-	-	B9428T	-	-	-	-	-
	BA	PBB612428	PBB120428	-	PBB6428	PBB36428	-	-	-	-	-	-	-	-	-
PIETRA DI BARGE	ST	-	-	-	PS6255	PS36255	PS615255M	-	-	BS9255T	PEL15255	PELR15255	-	GS6255R1	GS3255R1
	SA	-	-	-	P6255	P36255	P615255	-	-	B9255T	-	-	-	GR6255R1	GR3255R1
PIETRA DI BORGOGNA	ST	-	-	-	PS6332	PS36332	PS615332	-	-	BS9332T	PEL15332	-	-	GS6332R1	GS3332R1
	SA	-	-	P49332	P6332	P36332	P615332	B90332T	B9332T	-	-	-	-	GR6332R1	GR3332R1
PIETRA DI LUSERNA	ST	-	-	-	PS6264	PS36264	PS615264	-	-	BS9264T	PEL15264	PELR15264	-	GS6264R1	GS3264R1
	SA	-	-	-	P36264	P615264	-	-	B9264T	-	-	-	-	GR6264R1	GR3264R1
PIETRA DI RAGUSA	ST	-	-	PS49302	PS6302	PS36302	PS615302	BS90302T	BS9302T	PEL15302	-	-	-	GS6302R1	GS3302R1
PIETRA GIALLA	ST	-	-	-	-	PS36257	PS615257	-	-	BS9257T	PEL15257	-	-	GS6257R1	GS3257R1
	SA	-	-	-	-	P36257	P615257	-	-	B9257T	-	-	-	GR6257R1	GR3257R1
PIETRA PIASENTINA	ST	PS612259	-	-	PS6259	PS36259	PS615259M	-	-	BS9259T	PEL15259	PELR15259	-	GS6259R1	GS3259R1
	SA	-	-	-	P6259	P36259	P615259	-	-	B9259T	-	-	-	GR6259R1	GR3259R1
PIETRA SINTRA	SL	P612392	-	-	P6392	P36392	P615392	-	-	B9392T	-	-	-	GR6392R1	-
	ST	PS612392	-	-	PS6392	PS36392	PS615392	-	-	BS9392T	-	-	-	GS6392R1	-
QUARZITE BIANCA	SL	P612393	-	-	P6393	P36393	P615393	-	-	B9393T	-	-	-	GR6393R1	-
	ST	PS612393	-	-	PS6393	PS36393	PS615393	-	-	BS9393T	-	-	-	GS6393R1	-
SILK GEORGETTE	N	P612429	P120429	-	P6429	P36429	-	-	-	B9429T	-	-	-	GR6429R1	-
	BA	PBB612429	PBB120429	-	PBB6429	PBB36429	-	-	-	-	-	-	-	-	-

MOSAICI MOSAICS / MOSAIKEN / MOSAÏQUES

FINITURA /
FINISH /
OBERFLÄCHEN-
AUSFÜHRUNG /
FINITION

MOSAICO



30x30
12"x12"

MOSAICO
CLASSIC



30x30
12"x12"

MOSAICO
BLITZ



30x30
12"x12"

MODULO
RANDOM



60x30
24"x12"

MOSAICI MOSAICS / MOSAIKEN / MOSAÏQUES

FINITURA /
FINISH /
OBERFLÄCHEN-
AUSFÜHRUNG /
FINITION

MOSAICO



30x30
12"x12"

MOSAICO
CLASSIC



30x30
12"x12"

MOSAICO
BLITZ



30x30
12"x12"

MODULO
RANDOM



60x30
24"x12"

ARDESIA ANTRACITE	SL	-	-	BLISA390	-
	ST	-	MCST390	-	MRST390
BASALTO GRIGIO	ST	MOS330M	MCST330	BLIST330	-
	SA	MOS330SM	-	BLISA330	-
BLACK ARDESIA	ST	MOS277M	MCST277	BLIST277	MRST277
	SA	MOS277SM	-	-	-
CADAPPA BLACK	SL	-	-	BLISA391	-
	ST	-	MCST391	-	MRST391
CREMA EUROPA	ST	MOS296M	MCST296	BLIST296	MRST296
	SA	MOS296SM	-	-	-
LIMRA	ST	MOS331M	MCST331	BLIST331	-
	SA	MOS331SM	-	BLISA331	-
PIETRA DI BARGE	ST	MOS255M	MCST255	BLIST255	MRST255
	SA	MOS255SM	-	-	-

PIETRA DI BORGOGNA	ST	MOS332M	MCST332	BLIST332	MRST332
	SA	MOS332SM	-	BLISA332	-
PIETRA DI LUSERNA	ST	MOS264M	MCST264	BLIST264	MRST264
	SA	MOS264SM	-	-	-
PIETRA DI RAGUSA	ST	-	-	-	MRST302
PIETRA GIALLA	ST	MOS257M	-	BLIST257	MRST257
	SA	MOS257SM	-	-	-
PIETRA PIASENTINA	ST	MOS259M	MCST259	BLIST259	MRST259
	SA	MOS259SM	-	-	-
PIETRA SINTRA	SL	-	-	BLISA392	-
	ST	-	MCST392	-	MRST392
QUARZITE BIANCA	SL	-	-	BLISA393	-
	ST	-	MCST393	-	MRST393

ST: Strutturato / Structured / Strukturiert / Structuré
BA: Bamboo
SA: Satinato / Satin-finish / Satiniert / Satiné

SL: Semilucidato / Semi-polished / Semi-matt / Semi-lustré
L: Lucidato
N: Naturale / Natural / Naturbelassen / Naturel

LL: Levigato e lucidato / Honed and polished / Geschliffen und poliert / Poli et lustré
SO: Soft

PEZZI SPECIALI / TRIMS / FORMTEILE / PIÈCES SPÉCIALES

GRADONE COSTA RETTA /
 COSTA RETTA STEP TREAD /
 STUFE COSTA RETTA /
 NEZ DE MARCHE COSTA RETTA

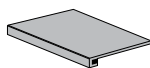

FINITURA /
 FINISH /
 OBERFLÄCHEN
 AUSFÜHRUNG /
 FINITION

120x34
 48"x13^{1/2}"

90x34
 36"x13^{1/2}"

60x34
 24"x13^{1/2}"

30x34
 12"x13^{1/2}"

		120x34 48"x13 ^{1/2} "	90x34 36"x13 ^{1/2} "	60x34 24"x13 ^{1/2} "	30x34 12"x13 ^{1/2} "
ARDESIA ANTRACITE	SL	PGRSA12390	-	PGRSA60390	PGRSA30390
	ST	PGRST12390	-	PGRST60390	PGRST30390
BASALTO GRIGIO	ST	-	-	PGRST60330	PGRST30330
	SA	PGRSA12330	-	PGRSA60330	PGRSA30330
BLACK ARDESIA	ST	PGRST12277	PGRST90277	PGRST60277	PGRST30277
	SA	-	PGRSA90277	PGRSA60277	PGRSA30277
CADAPPA BLACK	SL	PGRSA12391	-	PGRSA60391	PGRSA30391
	ST	PGRST12391	-	PGRST60391	PGRST30391
CREMA EUROPA	ST	PGRST12296	PGRST90296	PGRST60296	PGRST30296
	SA	-	PGRSA90296	PGRSA60296	-
LIMRA	ST	-	-	PGRST60331	PGRST30331
	SA	PGRSA12331	-	PGRSA60331	PGRSA30331
PIETRA D'AVOLA	N	PGRN12428	-	PGRN60428	-
	ST	-	-	-	-
PIETRA DI BARGE	ST	-	-	PGRST60255	PGRST30255
	SA	-	-	PGRSA60255	PGRSA30255
PIETRA DI BORGOGNA	ST	-	-	PGRST60332	PGRST30332
	SA	-	PGRSA90332	PGRSA60332	PGRSA30332
PIETRA DI LUSERNA	ST	-	-	PGRST60264	PGRST30264
	SA	-	-	-	PGRSA30264
PIETRA DI RAGUSA	ST	-	PGRST90302	PGRST60302	PGRST30302
PIETRA GIALLA	ST	-	-	-	PGRST30257
	SA	-	-	-	PGRSA30257
PIETRA PIASENTINA	ST	PGRST12259	-	PGRST60259	PGRST30259
	SA	-	-	PGRSA60259	PGRSA30259
PIETRA SINTRA	SL	PGRSA12392	-	PGRSA60392	PGRSA30392
	ST	PGRST12392	-	PGRST60392	PGRST30392
QUARZITE BIANCA	SL	PGRSA12393	-	PGRSA60393	PGRSA30393
	ST	PGRST12393	-	PGRST60393	PGRST30393
SILK GEORGETTE	N	PGRN12429	-	PGRN60429	-
	BA	-	-	-	-

ANGOLARE COSTA RETTA /
 COSTA RETTA STEP TREAD CORNER /
 ECKSTUFE COSTA RETTA /
 NEZ DE MARCHE COSTA RETTA AVEC ANGLE

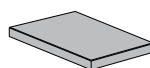

120x34
 48"x13^{1/2}"

90x34
 36"x13^{1/2}"

60x34
 24"x13^{1/2}"

30x34
 12"x13^{1/2}"

		120x34 48"x13 ^{1/2} "	90x34 36"x13 ^{1/2} "	60x34 24"x13 ^{1/2} "	30x34 12"x13 ^{1/2} "
PRASA12390	-	-	-	PRASA60390	PRASA30390
PRAST12390	-	-	-	PRAST60390	PRAST30390
PRASA12330	-	-	-	PRASA60330	PRASA30330
PRAST12277	PRAST90277	PRAST60277	PRAST30277	-	-
PRASA12391	PRASA90277	PRASA60277	PRASA30277	-	-
PRAST12391	-	PRAST60391	PRAST30391	-	-
PRAST12296	PRAST90296	PRAST60296	PRAST30296	-	-
-	PRASA90296	-	PRASA30296	-	-
-	-	PRAST60331	PRAST30331	-	-
PRASA12331	-	PRASA60331	PRASA30331	-	-
PRAN12428	-	PRAN60428	-	-	-
-	-	-	-	-	-
-	-	PRAST60255	PRAST30255	-	-
-	-	PRASA60255	PRASA30255	-	-
-	-	PRAST60332	PRAST30332	-	-
-	PRASA90332	PRASA60332	PRASA30332	-	-
-	-	PRAST60264	PRAST30264	-	-
-	-	-	PRASA30264	-	-
-	PRAST90302	PRAST60302	PRAST30302	-	-
-	-	-	PRAST30257	-	-
-	-	-	PGRSA30257	-	-
PRAST12259	-	PRAST60259	PRAST30259	-	-
-	-	PGRSA60259	PGRSA30259	-	-
PRASA12392	-	PRASA60392	PRASA30392	-	-
PRAST12392	-	PRAST60392	PRAST30392	-	-
PRASA12393	-	PRASA60393	PRASA30393	-	-
PRAST12393	-	PRAST60393	PRAST30393	-	-
PRAN12429	-	PRAN60429	-	-	-
-	-	-	-	-	-

IRIDIUM

CODICI E FORMATI /
 CODES AND SIZES /
 ARTIKELNR. UND FORMATE /
 CODES ET FORMATS

SPESORE: /
 THICKNESS: /
 DICKE: /
 ÉPAISSEUR:

10mm

FINITURA /
 FINISH /
 OBERFLÄCHEN
 AUSFÜHRUNG /
 FINITION



60x60
 24"x24"



60x30
 24"x12"

**PEZZI SPECIALI
 TRIMS /
 FORMTEILE /
 PIÈCES SPÉCIALES**

FINITURA /
 FINISH /
 OBERFLÄCHEN
 AUSFÜHRUNG /
 FINITION

BATTISCOPA /
 BULLNOSE /
 STEHSCOCKEL /
 PLINTHE



60x9
 24"x3^{3/5}"

BIANCO	LL	PL6353	PL36353
	SO	P6353	P36353
NERO	LL	PL6357	PL36357
	SO	P6357	P36357

LL	BL6353AN
SO	B6353T
LL	BL6357AN
SO	B6357T

CM2 ARIOSTEA HIGH-TECH

CODICI E FORMATI /
CODES AND SIZES /
ARTIKELNR. UND FORMATE /
CODES ET FORMATS

AN: Anticato / Antiqued / Antik / Antique

AS: Antislip

ST: Strutturato / Structured / Strukturiert / Structuré

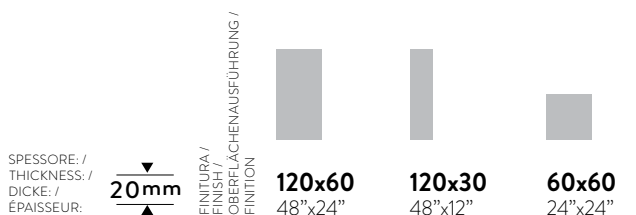

CREMA EUROPA	ST	-	-	PMS60296
PIETRA DI RAGUSA	ST	-	-	PMS60302
PIETRA PIASENTINA	ST	-	-	PMS60259
BASALTO GRIGIO	ST	-	-	PMS60330
ABSOLUTE BLACK	ST	PMS612413	-	PMS60413
ROVERE BRICCOLA	AN	PMA612425	PMA30425	-
ROVERE CENERE	AN	PMA612397	PMA30397	-
ROVERE GRIGIO	AN	PMA612335	PMA30335	-
ROVERE IMPERO	AN	PMA612386	PMA30386	-
ROVERE SABBIA	AN	PMA612396	PMA30396	-
ROVERE TUNDRA	AN	PMA612380	PMA30380	-
FANGO	AS	PMS612453	-	PMS60453
CENERE	AS	PMS612452	-	PMS60452
DIORITE	AS	PMS612475	-	PMS60475
PELTRO	AS	PMS612476	-	PMS60476
LIGHT GREY	AS	PMS612503	-	PMS60503
SMOKE	AS	PMS612505	-	PMS60505
SOFT BLACK	AS	PMS612506	-	PMS60506
CLOUD	AS	PMS612562	-	PMS60562
EARTH	AS	PMS612563	-	PMS60563
INK	AS	PMS612564	-	PMS60564
TALC	AS	PMS612565	-	PMS60565
DOVE GREY	AS	PMS612576	-	PMS60576

PEZZI SPECIALI TRIMS / FORMTEILE / PIÈCES SPÉCIALES

GRADONE BECCO CM2
STEPTREAD WITH HALF
BULLNOSE EDGE /
STUFENPLATTE MIT
ABGERUNDETER KANTE /
NEZ DE MARCHE AVEC BORD
ARRONDI

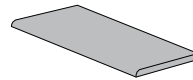

60x30
24"x12"

GMS6296B1
GMS6302B1
GMS6259B1
GMS6330B1
GMS6413B1

GRADONE TORO CM2
STEPTREAD GRADONE
TORO CM2 /
STUFENPLATTE GRADONE
TORO CM2 /
NEZ DE MARCHE
ÉPAISSEUR 2CM

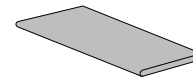

60x30
24"x12"

GMST6296
GMST6302
GMST6259
GMST6330
GMST6413

GRIGLIA CM2
WATER GRATE /
ABDECKPLATTE WASSERABLAUF /
GRILLE

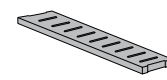

60x15
24"x6"

GRIGLIA296
GRIGLIA302
GRIGLIA259
GRIGLIA330
GRIGLIA413

GMS6453B1
GMS6452B1
GMS6475B1
GMS6476B1
GMS6503B1
GMS6505B1
GMS6506B1
GMS6562B1
GMS6563B1
GMS6564B1
GMS6565B1
GMS6576B1

GMST6453
GMST6452
GMST6475
GMST6476
GMST6503
GMST6505
GMST6506
GMST6562
GMST6563
GMST6564
GMST6565
GMST6576

GRIGLIA453
GRIGLIA452
GRIGLIA475
GRIGLIA476
GRIGLIA503
GRIGLIA505
GRIGLIA506
GRIGLIA562
GRIGLIA563
GRIGLIA564
GRIGLIA565
GRIGLIA576

INNOVATIVE SLABS LEGNI HIGH-TECH

CODICI E FORMATI /
CODES AND SIZES /
ARTIKELNR. UND FORMATE /
CODES ET FORMATS

PEZZI SPECIALI TRIMS / FORMTEILE / PIÈCES SPÉCIALES

BATTISCOPA / BULLNOSE /
STEHSCOCKEL / PLINTHE

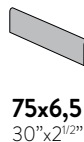
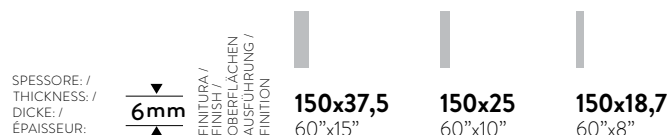

QUERCIA BIANCA	AN	PAR37448S6	PAR25448S6	PAR18448S6	BA75448T
QUERCIA PETRAEA	AN	PAR37449S6	PAR25449S6	PAR18449S6	BA75449T
QUERCIA TROPICALE	AN	PAR37450S6	PAR25450S6	PAR18450S6	BA75450T
QUERCIA CANADESE	AN	PAR37482S6	PAR25482S6	PAR18482S6	BA75482T
QUERCIA SHABBY	AN	PAR37483S6	PAR25483S6	PAR18483S6	BA75483T

WOODDRAW

CODICI E FORMATI /
CODES AND SIZES /
ARTIKELNR. UND FORMATE /
CODES ET FORMATS

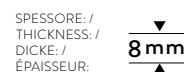

ARTIC	AN	PAR20488
ASH	AN	PAR20489
BOARD	AN	PAR20490
POWDER	AN	PAR20491
RUST	AN	PAR20492

LEGNI HIGH-TECH

CODICI E FORMATI /
CODES AND SIZES /
ARTIKELNR. UND FORMATE /
CODES ET FORMATS

AN: Anticato / Antiqued / Antik / Antique

SPESORE: /
THICKNESS: /
DICKE: /
ÉPAISSEUR:

10mm

FINITURA /
FINISH /
OBERFLÄCHENAUFÜHRUNG /
FINITION

120x30
48"x12"

120x20
48"x8"

120x15
48"x6"

90x22,5
36"x9"

90x15
36"x6"

90x11
36"x4 1/2"

ROVERE ABBAZIA	AN	-	-	-	PAR22364	PAR15364	PAR11364
ROVERE ANTICO	AN	-	-	-	PAR22334	PAR15334	PAR11334
ROVERE BIANCO	AN	-	-	-	PAR22342	PAR15342	PAR11342
ROVERE BRICCOLA	AN	PAR30425	PAR20425	PAR115425	-	-	-
ROVERE CENERE	AN	PAR30397	PAR20397	PAR115397	-	-	-
ROVERE CILIEGIO	AN	-	-	-	PAR22336	PAR15336	PAR11336
ROVERE CORDA	AN	PAR30379	PAR20379	PAR115379	-	-	-
ROVERE DECAPÈ	AN	PAR30389	PAR20389	PAR115389	-	-	-
ROVERE GRIGIO	AN	-	-	-	PAR22335	PAR15335	PAR11335
ROVERE IMPERO	AN	PAR30386	PAR20386	PAR115386	-	-	-
ROVERE MOKA	AN	-	-	-	PAR22323	PAR15323	PAR11323
ROVERE NATURALE	AN	-	-	-	PAR22365	PAR15365	PAR11365
ROVERE NERO	AN	-	-	-	PAR22320	PAR15320	PAR11320
ROVERE NOCE	AN	PAR30395	PAR20395	PAR115395	-	-	-
ROVERE PROVENZALE	AN	PAR30424	PAR20424	PAR115424	-	-	-
ROVERE REALE	AN	PAR30387	PAR20387	PAR115387	-	-	-
ROVERE SABBIA	AN	PAR30396	PAR20396	PAR115396	-	-	-
ROVERE TUNDRA	AN	PAR30380	PAR20380	PAR115380	-	-	-

PEZZI SPECIALI TRIMS / FORMTEILE / PIÈCES SPÉCIALES

FINITURA /
FINISH /
OBERFLÄCHENAUFÜHRUNG /
FINITION

BATTISCOPA /
BULLNOSE /
STEHSOCKEL /
PLINTHE



90x9
36"x3 3/5"

60x9
24"x3 3/5"

GRADONE COSTA RETTA /
COSTA RETTA STEP TREAD /
STUFE COSTA RETTA /
NEZ DE MARCHE COSTA RETTA

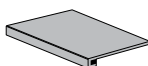

120x34
48"x13 1/2"

90x34
36"x13 1/2"

45x34
17 3/4"x13 1/2"

ANGOLARE COSTA RETTA /
COSTA RETTA STEP TREAD CORNER /
ECKSTUFE COSTA RETTA /
NEZ DE MARCHE COSTA RETTA AVEC ANGLE

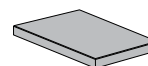

120x34
48"x13 1/2"

90x34
36"x13 1/2"

45x34
17 3/4"x13 1/2"

ROVERE ABBAZIA	AN	BA90364T	-	-	PGRA90364	PGRA45364	-	PRAA90364	PRAA45364
ROVERE ANTICO	AN	BA90334T	-	-	PGRA90334	PGRA45334	-	PRAA90334	PRAA45334
ROVERE BIANCO	AN	BA90342T	-	-	PGRA90342	PGRA45342	-	PRAA90342	PRAA45342
ROVERE BRICCOLA	AN	-	BA9425T	PGRA12425	-	-	PRAA12425	-	-
ROVERE CENERE	AN	-	BA9397T	PGRA12397	-	-	PRAA12397	-	-
ROVERE CILIEGIO	AN	BA90336T	-	-	PGRA90336	PGRA45336	-	PRAA90336	PRAA45336
ROVERE CORDA	AN	-	BA9379T	PGRA12379	-	-	PRAA12379	-	-
ROVERE DECAPÈ	AN	-	BA9389T	PGRA12389	-	-	PRAA12389	-	-
ROVERE GRIGIO	AN	BA90335T	-	-	PGRA90335	PGRA45335	-	PRAA90335	PRAA45335
ROVERE IMPERO	AN	-	BA9386T	PGRA12386	-	-	PRAA12386	-	-
ROVERE MOKA	AN	BA90323T	-	-	PGRA90323	PGRA45323	-	PRAA90323	PRAA45323
ROVERE NATURALE	AN	BA90365T	-	-	PGRA90365	PGRA45365	-	PRAA90365	PRAA45365
ROVERE NERO	AN	BA90320T	-	-	PGRA90320	PGRA45320	-	PRAA90320	PRAA45320
ROVERE NOCE	AN	-	BA9395T	PGRA12395	-	-	PRAA12395	-	-
ROVERE PROVENZALE	AN	-	BA9424T	PGRA12424	-	-	PRAA12424	-	-
ROVERE REALE	AN	-	BA9387T	PGRA12387	-	-	PRAA12387	-	-
ROVERE SABBIA	AN	-	BA9396T	PGRA12396	-	-	PRAA12396	-	-
ROVERE TUNDRA	AN	-	BA9380T	PGRA12380	-	-	PRAA12380	-	-

PEZZI SPECIALI / TRIMS /
FORMTEILE / PIÈCES SPÉCIALES

ANGOLARE COSTA RETTA /
COSTA RETTA STEP TREAD CORNER / ECKESTUFE COSTA RETTA /
NEZ DE MARCHE COSTA RETTA AVEC ANGLE

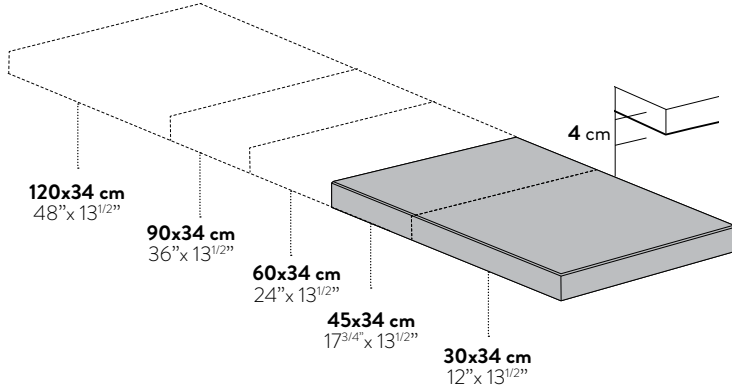

GRADONE COSTA RETTA /
COSTA RETTA STEP TREAD / STUFE COSTA RETTA / NEZ DE MARCHE COSTA RETTA

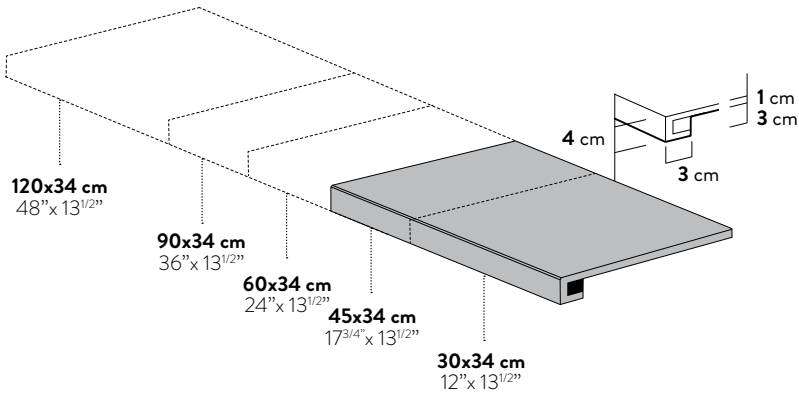

BATTISCOPIA /
BULLNOSE / STEH SOCKEL / PLINTHE

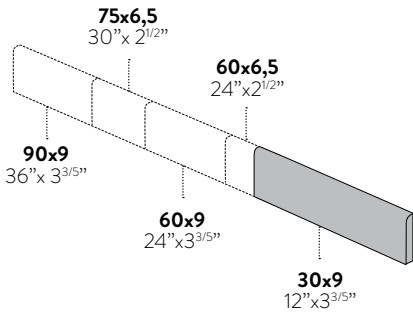

GRADINO CLASSICO /
STEP TREAD / STUFENPLATTE / NEZ DE MARCHE

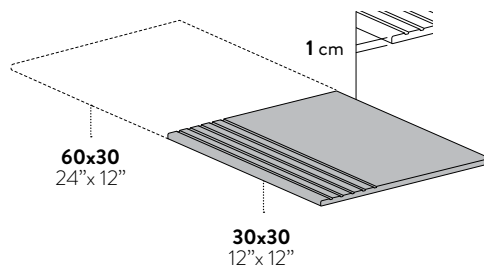

ELEMENTO A "L" COSTA RETTA /
COSTA RETTA "L" ÉLÉMENT / LÄNGSSCHENKEL COSTA RETTA /
ÉLÉMENT EN "L" COSTA RETTA

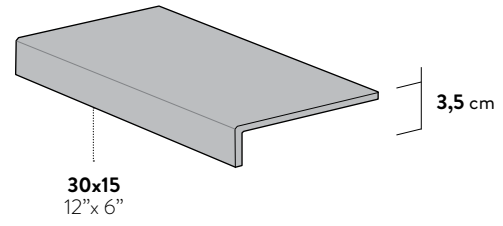

ELEMENTO A "L" /
"L" - SHAPED ÉLÉMENT / SCHENKEL / ÉLÉMENT EN "L"

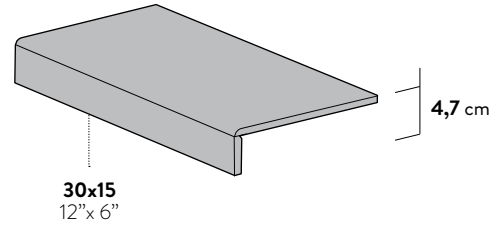

GRADONE TORO CM2 /
STEPTREAD GRADONE TORO CM2 / STUFENPLATTE TORO CM2 /
NEZ DE MARCHE ÉPAISSEUR 2 CM

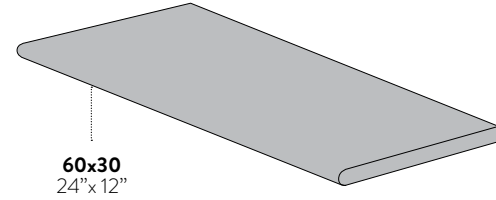

GRADONE BECCO CM2 /
STEPTREAD WITH HALF BULLNOSE EDGE /
STUFENPLATTE MIT ABGERUNDETER KANTE /
NEZ DE MARCHE AVEC BORD ARRONDI

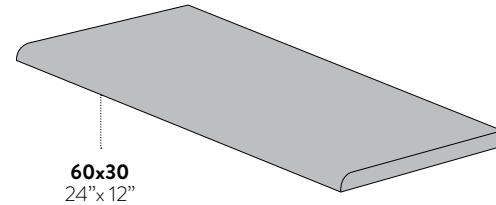

GRIGLIA CM2
WATER GRATE / ABDECKPLATTE WASSERABLAUF / GRILLE

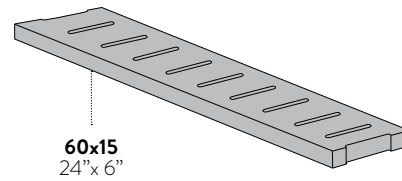

MOSAICI / MOSAICS / MOSAIKEN / MOSAÏQUES

MOSAICO BLITZ
30x30 12"x 12"

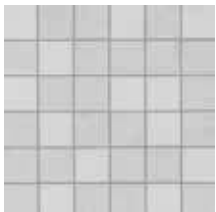

MOSAICO
30x30 12"x 12"



MOSAICO CLASSIC
30x30 12"x 12"



MODULO RANDOM
60x30 24"x 12"





**IMBALLAGGI E PESI / PACKING AND WEIGHTS /
VERPACKUNG UND GEWICHT / EMBALLAGES ET POIDS**

AN: Anticato / Antiqued / Antik / Antique
AS: Antislip
BA: Bamboo
N: Naturale / Natural / Naturbelassen / Naturel
PRL: PreLucidato
SA: Satinato / Satin-finish / Satiniert / Satiné
SL: Semilucidato / Semi-polished / Semi-matt / Semi-lustré
SO: Soft
ST: Strutturato / Structured / Strukturiert / Structuré
L: Lucidato
SK: Levigato Silk



FORMATI E SPESSORI/ SIZES AND THICKNESS/ FORMATE UND STÄRKE/ FORMATS ET ÉPAISSEUR	1000 x 2000 mm 9,0 mm	1500 x 750 mm 6,0 mm	1500 x 375 mm 6,0 mm	1500 x 250 mm 6,0 mm	1500 x 187 mm 6,0 mm	1000 x 1000 mm 9,0 mm	750 x 750 mm 6,0 mm	1200 x 600 mm 10,0 mm	1200 x 600 mm 9,0 mm	1200 x 600 mm 8,0 mm	1200 x 600 mm 20,0 mm	1200 x 300 mm 10,0 mm	1200 x 300 mm 10,0 mm
Collezione / Collection Kollektion / Collection	Marmi cento2cento Pietre cento2cento	Materie high-tech Teknostone	Innovative slabs Legni high-tech	Innovative slabs Legni high-tech	Innovative slabs Legni high-tech	Marmi cento2cento Pietre cento2cento	Materie high-tech Teknostone	Pietre naturali high-tech Greenstone Materie high-tech	Northstone Con.Crea.	Marmi Classici Teknostone	Pietre naturali Legni high-tech Teknostone Materie H.T. Con.Crea. 	Legni high-tech	Pietre naturali high-tech
Finitura / Finish Oberflächenführung / Finition	SO/L	SO/N	AN	AN	AN	SO/L	SO/N	ST/SA/SL/BA SO/N	N/SK/ AS/PRL	L/SO/N SK	AN/ST/AS	AN	N/BA
Pezzi scatola / Pieces box Stücke karton / Pièces boîte	1	2	3	4	5	1	3	2	2	2	1	3	3
Mq. Scatola / Sq. Mt. Box Qm. Karton / m² boîte	2,00	2,25	1,688	1,50	1,406	1,00	1,688	1,44	1,44	1,44	0,72	1,08	1,08
Peso scatola / Weight box Gewicht karton / Poids boîte	42,20	31,66	23,743	21,105	19,79	21,10	23,743	31,824	30,384	25,92	32,12	24,17	23,88
Peso mq. / Sq. Mt. Weight Qm. Gewicht / Poids m²	21,10	14,07	14,07	14,07	14,07	21,10	14,07	22,10	21,10	18,00	44,60	22,38	22,10
Scatole pallet / Box pallet Karton palette / Boîte palette	15	26	18	24	24	31	38	25	24	27	25	32	32
Mq. Pallet / Sq. Mt. Pallet Qm. Palette / m² palette	30,00	58,50	30,38	36,00	33,74	31,00	64,144	36,00	34,56	38,88	18,00	34,56	34,56
Peso pallet / Weight pallet Gewicht palette / Poids palette	710	850	440	520	490	690	940	800	730	710	810	768,66	770





FORMATI E SPESSORI/ SIZES AND THICKNESS/ FORMATE UND STÄRKE/ FORMATS ET ÉPAISSEUR	1200 x 300 mm 20,0 mm	1200 x 200 mm 10,0 mm	1200 x 200 mm 8,0 mm	1200 x 150 mm 10,0 mm	900 x 450 mm 10,0 mm	900x 225 mm 10,0 mm	900x 150 mm 10,0 mm	900x 110 mm 10,0 mm	600x 600 mm 20,0 mm	600 x 600 mm 10,0 mm	600 x 600 mm 10,0 mm	600 x 600 mm 9,0 mm
Collezione / Collection Kollektion / Collection	Legni high-tech 	Legni high-tech	Woodraw	Legni high-tech	Pietre high-tech	Legni high-tech	Legni high-tech	Legni high-tech	Pietre naturali high-tech Teknostone Materie high-tech Con.Crea. 	Pietre naturali high-tech Greenstone Materie high-tech	Iridium	Northstone Con.Crea.
Finitura / Finish Oberflächenführung / Finition	AN/AS	AN	AN	AN	ST/SA	AN	AN	AN	ST/AS	ST/SA/BC/ SL/BA/SO/N	LL	SO N/SK/ AS/PRL
Pezzi scatola / Pieces box Stücke karton / Pièces boîte	2	4	6	6	3	6	9	11	2	3	3	3 3
Mq. Scatola / Sq. Mt. Box Qm. Karton / m² boîte	0,72	0,96	1,44	1,08	1,215	1,215	1,215	1,089	0,72	1,08	1,08	1,08 1,08
Peso scatola / Weight box Gewicht karton / Poids boîte	32,12	21,485	24,78	24,17	26,80	27,24	27,24	24,415	32,00	22,84	22,50	24,00 22,788
Peso mq. / Sq. Mt. Weight Qm. Gewicht / Poids m²	44,60	22,38	17,21	22,38	22,00	22,42	22,42	22,42	44,60	21,15	20,85	22,22 21,10
Scatole pallet / Box pallet Karton palette / Boîte palette	24	36	32	36	32	18	24	20	30	40	40	40 40
Mq. Pallet / Sq. Mt. Pallet Qm. Palette / m² palette	17,28	34,56	46,08	38,88	38,88	21,87	29,16	21,78	21,60	43,20	43,20	43,20 43,20
Peso pallet / Weight pallet Gewicht palette / Poids palette	780	768,06	800	865	850	420	560	500	960	920	900	960 912



IMBALLAGGI E PESI / PACKING AND WEIGHTS /
 VERPACKUNG UND GEWICHT / EMBALLAGES ET POIDS

FORMATI E SPESSORI/ SIZES AND THICKNESS/ FORMATE UND STÄRKE/ FORMATS ET ÉPAISSEUR	600 x 600 mm 8,0 mm	600 x 600 mm 8,0 mm	600 x 300 mm 10,0 mm	600 x 300 mm 10,0 mm	600 x 300 mm 9,0 mm	600 x 300 mm 8,0 mm	600 x 150 mm 10,0 mm
Collezione / Collection Kollektion / Collection	Teknostone	Marmi classici	Pietre naturali high-tech Greenstone Materie high-tech	Iridium	Northstone Con.Crea.	Marmi classici Teknostone	Pietre naturali high-tech Greenstone
Finitura / Finish Oberflächenausführung / Finition	N	L/SO/SK	ST/SA/BC/ SL/BA/SO/N	LL/SO	N/SK/AS/PRL	L/SO/N/SK	ST/SA/SL
Pezzi scatola / Pieces box Stücke karton / Pièces boîte	4	4	6	8	6	8	10
Mq. Scatola / Sq. Mt. Box Qm. Karton / m ² boîte	1,44	1,44	1,08	1,44	1,08	1,44	0,9
Peso scatola / Weight box Gewicht karton / Poids boîte	25,92	25,92	22,84	30,02	22,79	25,92	19,00
Peso mq. / Sq. Mt. Weight Qm. Gewicht / Poids m ²	18,00	18,00	21,15	20,85	21,10	18,00	21,15
Scatole pallet / Box pallet Karton palette / Boîte palette	32	30	40	32	40	40	48
Mq. Pallet / Sq. Mt. Pallet Qm. Palette / m ² palette	46,08	43,20	43,20	46,08	43,20	57,60	43,20
Peso pallet / Weight pallet Gewicht palette / Poids palette	840	790	920	960	912	1040	912

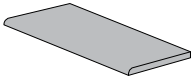
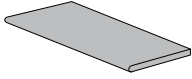
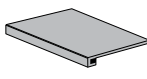
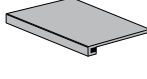
AN: Anticato / Antiqued / Antik / Antique
AS: Antislip
BA: Bamboo
N: Naturale / Natural / Naturbelassen / Naturel
PRL: Prelucidato
SA: Satinato / Satin-finish / Satiniert / Satiné
SL: Semilucidato / Semi-polished / Semi-matt / Semi-lustré
SO: Soft
ST: Strutturato / Structured / Strukturiert / Structuré
L: Lucidato
SK: Levigato Silk

**PEZZI SPECIALI
TRIMS /
FORMTEILE /
PIÈCES SPÉCIALES**

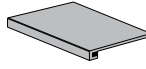
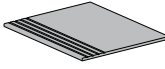
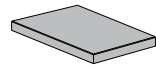
FORMATI E SPESSORI/ SIZES AND THICKNESS/ FORMATE UND STÄRKE/ FORMATS ET ÉPAISSEUR	Gradone becco cm2 Stepread with half bullnose edge / Stufenplatte mit abgerundeter kante / Nez de marche avec bord arrondi		Gradone toro cm2 Stepread gradone toro cm2 / Stufenplatte gradone toro cm2 / Nez de marche épaisseur 2cm		Gradone costa retta / Costa retta step tread / Stufe costa retta / Nez de marche costa retta							
												
	600 x 300 mm 20,0 mm	600 x 300 mm 20,0 mm	1200 x 340 mm 10,0 mm	1200 x 340 mm 10,0 mm	900 x 340 mm 10,0 mm	900 x 340 mm 10,0 mm	600 x 340 mm 10,0 mm	450 x 340 mm 10,0 mm				
Collezione / Collection Kollektion / Collection	CM2 Pietre naturali high-tech Teknostone Materie high-tech Con.Crea. 		CM2 Pietre naturali high-tech Teknostone Materie high-tech Con.Crea. 		Pietre naturali high-tech Materie high-tech		Legni high-tech Greenstone		Pietre naturali high-tech Greenstone Materie high-tech			
Finitura / Finish Oberflächenausführung / Finition	ST/AS		ST/AS		ST/SA/SO/N		AN/SA/SL		ST/SA		AN	
Pezzi scatola / Pieces box Stücke karton / Pièces boîte	1		1		1		1		1		4	
Mq. Scatola / Sq. Mt. Box Qm. Karton / m ² boîte	0,6 Lin. mt		0,6 Lin. mt		1,20 Lin. mt		1,20 Lin. mt		0,9 Lin. mt		0,9 Lin. mt	
Peso scatola / Weight box Gewicht karton / Poids boîte	8,00		8,00		12,40		12,40		9,30		9,30	

FORMATI E SPESSORI/ SIZES AND THICKNESS/ FORMATE UND STÄRKE/ FORMATS ET ÉPAISSEUR	Gradone costa retta / costa retta step tread / Stufe costa retta / nez de marche costa retta		Gradino classico / Sep tread / Stufenplatte / Nez de marche		Angolare costa retta / Costa retta step Tread corner / Eckstufe costa retta / Nez de marche costa retta avec angle			
								
	300 x 340 mm 10,0 mm	300 x 340 mm 9,0 mm	600 x 300 mm 8,0/9,0/10,0 mm	300 x 300 mm 10,0 mm	1200 x 340 mm 10,0 mm	1200 x 340 mm 10,0 mm	900 x 340 mm 10,0 mm	900 x 340 mm 10,0 mm
Collezione / Collection Kollektion / Collection	Pietre naturali high-tech	Greenstone	Pietre naturali high-tech Marmi classici Greenstone Teknostone Materie high-tech Northstone Con.Crea.	Pietre naturali high-tech	Pietre naturali high-tech	Legni high-tech	Pietre naturali high-tech	Legni high-tech
Finitura / Finish Oberflächenausführung / Finition	ST/SA	SA/ST/SL	ST/SA/SL/SO/ N/L/AS	ST/SA	ST/SA/SL/ SO/N	AN	ST/SA	AN
Pezzi scatola / Pieces box Stücke karton / Pièces boîte	4	4	8	11	1	1	1	1
Mq. Scatola / Sq. Mt. Box Qm. Karton / m ² boîte	1,20 Lin. mt	1,20 Lin. mt	4,80 Lin. mt	3,30 Lin. mt	1,20 Lin. mt	1,20 Lin. mt	0,90 Lin. mt	0,90 Lin. mt
Peso scatola / Weight box Gewicht karton / Poids boîte	12,40	12,40	31,90	21,45	13,70	13,70	10,30	9,30

**IMBALLAGGI E PESI / PACKING AND WEIGHTS /
VERPACKUNG UND GEWICHT / EMBALLAGES ET POIDS**

AN: Anticato / Antiqued / Antik /Antique
AS: Antislip
BA: Bamboo
N: Naturale / Natural / Naturbelassen / Naturel
PRL: Prelucidato
SA: Satinato / Satin-finish / Satiniert / Satiné
SL: Semilucidato / Semi-polished / Semi-matt / Semi-lustré
SO: Soft
ST: Strutturato / Structured / Strukturiert / Structuré
L: Lucidato
SK: Levigato Silk

FORMATI E SPESSORI/ SIZES AND THICKNESS/ FORMATE UND STÄRKE/ FORMATS ET ÉPAISSEUR	Angolare costa retta / Costa retta step Tread corner / Eckstufe costa retta / Nez de marche costa retta avec angle					elemento a "L"/ "L" element / Schenkel / Elément en "L"		Elemento a "L" costa retta / costa retta "L" element / Längsschenkel costa retta / Elément en "L" costa retta		Griglia / Water grate / Abdeckplatte Wasserablauf / Grille
	600 x 340 mm 10,0 mm	600 x 340 mm 10,0 mm	450 x 340 mm 10,0 mm	300 x 340 mm 10,0 mm	300 x 340 mm 9,0 mm	300 x 150 mm 10,0 mm	300 x 150 mm 10,0 mm	600 x 150 mm 20,0 mm		
Collezione / Collection Kollektion / Collection	Pietre naturali high-tech	Greenstone	Legni high-tech	Pietre naturali high-tech	Greenstone	Pietre naturali high-tech	Pietre naturali high-tech	CM2 Pietre naturali high-tech Teknostone Materie high-tech Con.Crea.		
Finitura / Finish Oberflächenausführung / Finition	ST/SA/ SO/N	SL/ST	AN	ST/SA	SA/ST/SL	ST	ST	ST/AS		
Pezzi scatola /Pieces box Stücke karton /Pièces boîte	2	2	2	2	2	8	8	1		
Mq. Scatola /Sq. Mt. Box Qm. Karton / m ² boîte	1,20 Lin. mt	1,20 Lin. mt	0,90 Lin. mt	0,60 Lin. mt	0,60 Lin. mt	2,40 Lin. mt	2,40 Lin. mt	0,6 Lin. mt		
Peso scatola / Weight box Gewicht karton / Poids boîte	13,60	13,60	10,40	6,90	6,90	9,16	12,00	3,80		

Formati / sizes Formate / format	Battiscopa-listello / Bullnose-listell / Stehsockel-leisten / Plinthe-listel		750 x 65 mm 6,0 mm	600 x 90 mm 10,0 mm	600 x 90 mm 10,0 mm	600 x 90 mm 10,0 mm	600 x 65 mm 8,0 / 9,0 mm
	900 x 90 mm 10,0 mm	900 x 90 mm 10,0 mm					
Collezione / Collection Kollektion / Collection	Pietre naturali high-tech	Legni high-tech	Innovative Slabs Legni high-tech Teknostone Materie high-tech	Pietre naturali high-tech Greenstone Materie high-tech	Legni high-tech	Iridium	Marmi classici Teknostone Northstone Con.Crea.
Finitura / Finish Oberflächenausführung / Finition	SA/ST	AN	AN/N/SO	SA/ST/ SO/N	AN	LL/SO	L/SO/N/SK/PRL
Pezzi scatola /Pieces box Stücke karton /Pièces boîte	6	6	12	10	10	10	10
Mq. Scatola /Sq. Mt. Box Qm. Karton / m ² boîte	5,4 Lin. mt	5,4 Lin. mt	9 Lin. mt	6,0 Lin. mt	6,0 Lin. mt	6,0 Lin. mt	6,0 Lin. mt
Peso scatola / Weight box Gewicht karton / Poids boîte	12,54	12,54	10,0	10,90	12,00	11,43	11,43

CONDIZIONI GENERALI DI VENDITA /
GENERAL SALES CONDITIONS /
ALLGEMEINE VERKAUFSBEDINGUNGEN /
CONDITIONS GENERALES DE VENTE

CONDIZIONI GENERALI DI VENDITA

1) NORMATIVA CONTRATTUALE - Le presenti condizioni generali, salvo eventuali modificazioni o deroghe concordate per iscritto, disciplinano tutti i contratti di vendita fra noi e l'acquirente, quindi tanto il contratto concluso con l'accettazione del presente ordine che qualsiasi contratto futuro relativo alle forniture dei prodotti della nostra società ordinati con successive e distinte commissioni. Le variazioni delle condizioni generali di vendita, le transazioni e gli abbuoni, anche se effettuati su iniziativa dei nostri Agenti, saranno impegnative per noi solo dopo nostra eventuale conferma scritta e comunque limitate ai contratti cui si riferiscono.

2) OGGETTO DELLA FORNITURA - La fornitura comprende solamente le prestazioni, i materiali ed i quantitativi specificati nella nostra conferma d'ordine o in altre comunicazioni scritte provenienti da noi. Il testo della nostra conferma d'ordine prevarrà in ogni caso sul testo difforme della eventuale offerta o della ordinazione.

L'esecuzione parziale dell'ordine senza preventiva conferma non significa nostra approvazione per l'intero ordine, bensì approvazione parziale relativamente alla merce consegnata. In questo caso la ricezione della merce equivarrà ad accettazione da parte dell'acquirente della nuova proposta contrattuale.

3) CONFERMA D'ORDINE - Qualora nella nostra conferma d'ordine esistano differenze nei singoli elementi che la compongono rispetto alle intese od alle ordinazioni, il compratore che non abbia contestato con lettera raccomandata spedita entro dieci giorni dalla ricezione della conferma tali differenze, è tenuto ad accettarla così come è stata redatta.

4) CONSEGNE - La merce, anche se venduta "franco arrivo", o franco domicilio del compratore, viaggia a rischio e pericolo di quest'ultimo ed ogni nostra responsabilità cessa con la consegna al vettore, nei confronti del quale il compratore, effettuate le opportune verifiche, dovrà sporgere eventuali reclami. Le spedizioni, via mare o via terra, concernenti forniture sull'estero, vengono

effettuate in base alle condizioni scelte di volta in volta, riportate negli "INCOTERMS" approvati dalla Camera di Commercio Internazionale nel 1953 e nei successivi.

5) TERMINI DI CONSEGNA - Il termine stabilito per la consegna della merce deve intendersi a favore di entrambi i contraenti. Qualora il materiale sia disponibile a magazzino, la ceramica Ariostea si impegna a spedirlo entro 8 giorni dalla data di ricevimento ordine, pertanto non verranno emesse conferme d'ordine. Salvo l'inserimento di particolari clausole, esso deve di norma considerarsi puramente indicativo e non essenziale. Quando siano intervenute modificazioni al contratto, il termine resta prorogato per un periodo uguale a quello inizialmente stabilito.

Ogni evento di forza maggiore sospende la decorrenza del termine per tutta la sua durata. Se in conseguenza di eventi di forza maggiore il contratto non potrà trovare esecuzione entro i 60 giorni successivi al termine convenuto, ognuna delle due parti avrà la facoltà di recedere dal contratto stesso.

In tal caso la dichiarazione di recesso dovrà essere spedita alla controparte, a mezzo lettera raccomandata con ricevuta di ritorno entro i dieci giorni successivi allo scadere dei predetti 60 giorni, restano esclusi reciproci diritti a indennizzi od a risarcimenti.

6) PAGAMENTI - Il luogo di pagamento è fissato presso la nostra Sede Amministrativa in Castellarano (Reggio E.) anche nel caso di emissione di tratte o ricevute bancarie, ovvero di rilascio di effetti cambiari, eventuale deroga a quanto sopra sarà valida soltanto se da noi concessa in forma scritta.

Per i pagamenti previsti in più rate l'importo dell'iva sarà comunque riscosso a mezza ricevuta bancaria con scadenza a 30 giorni data fattura. Il ritardo del pagamento, anche parziale delle nostre fatture oltre la pattuita scadenza darà luogo alla immediata decorrenza degli interessi di mora, calcolati al tasso ufficiale di sconto aumentato di 6 punti. Inoltre il mancato o ritardato pagamento delle fatture per qualsivoglia ragione ci darà diritto, impregiudicata ogni altra iniziativa, di pretendere il pagamento anticipato delle restanti forniture, oppure di ritenere

GENERAL SALES CONDITIONS

1) CONTRACTUAL REGULATIONS - These general sales conditions, save any modifications or variations agreed upon in writing, govern all sales contracts between us and the purchaser, thus including the contract concluded with the acceptance of this present order as well as any future contract related to the supply of our company's products ordered with subsequent and distinct commissions. Any variations on the general sales conditions, the transactions and allowances, even if made on the initiative of our Agent, will be binding for us only upon our written confirmation and in any case limited to the contracts to which they refer.

2) SUBJECT OF THE SUPPLY - The supply includes only the services, materials, and quantities specified in our acknowledgment of order or in other written communication sent by us. Should there be any differences in the offer or order, our acknowledgment of order is to be considered the only valid document. Partial processing of the order without our previous acknowledgment does not mean that we have approved the complete order, but rather partial acknowledgment relative to the goods delivered. In this case, reception of the goods shall be equivalent to acceptance on the part of the purchaser of the new contractual provisions.

3) ACKNOWLEDGMENT OF ORDER - Should there be any difference in the single items in our acknowledgment or order with respect to the agreements or orders, the buyer who has not made a claim by registered letter sent within ten days of receiving the acknowledgment shall be obliged to accept the acknowledgment as it is.

4) DELIVERY - The goods, even if sent freightpaid or free delivered to the buyer's premises, travel at the risk and responsibility of the buyer; all our responsibility ceases upon delivery of goods to the carrier. After the buyer has inspected the goods, any claims should be made to the carrier. Shipments by sea or by land regarding supplies abroad are made on the basis of the conditions chosen for each

specific case as specified in the "INCOTERMS" approved by the international Chamber of Commerce in 1953 and subsequent.

5) TERMS OF DELIVERY - The delivery date established must be mutually acceptable to both parties. If the material is available in our warehouse, Ceramica Ariostea undertake to ship it within 8 days of receiving the order, therefore no order confirmation will be issued. Unless specific clauses are introduced, this date is to be considered purely indicative and not binding. In the event that the contract is modified, the delivery date is extended for a period equal to that initially agreed upon.

Should any event caused by force majeure occur, the terms of delivery are suspended for the entire duration of said event. If, as a result of events of force majeure, the contract cannot be executed within 60 days of the date agreed upon, both parties shall be entitled to withdraw from the contract. In such case, the declaration of withdrawal must be sent to the counterpart by registered letter with return receipt within 10 days of the expiry of the aforementioned 60 days, and any indemnity or compensations are excluded.

6) PAYMENT - Payment is to be remitted to our registered office in Castellarano (Reggio E.) even if bills of exchange or bank drafts are issued; any variation to the aforementioned shall be valid only if approved by us in writing.

Delayed payment, even if only partial, of our invoices beyond the stipulated due date, shall entitle us to the immediate charge of interest on arrears in the order of the official rate increased by six points. Non-payment or delayed payment of our invoices - for any reason whatsoever - gives us the indisputable right to demand advance payment for the remaining supply, without prejudice of any other action, or to consider the contract suspended or annulled, and to annul the practice of any other contracts that may be in force, without giving the buyer the right to any type of refund or compensation for damages, or other.

temporaneamente sospeso o definitivamente risolto il contratto e di annullare l'evasione di eventuali altri ordini in corso, senza che il compratore possa avanzare pretese di compensi, indennizzi od altro.

7) SOLVE ET REPETE - Nessuna eccezione, salvo quelle di nullità, annullabilità e rescissione del contratto, può essere opposta dall'acquirente, al fine di ritardare od evitare il pagamento.

8) RISERVA DI PROPRIETÀ - Nel caso in cui il pagamento, per accordi contrattuali, debba essere effettuato in tutto o in parte dopo la consegna, i prodotti consegnati restano di nostra proprietà fino all'integrale pagamento del prezzo.

9) GARANZIA - I nostri materiali sono garantiti conformi alle Norme UNI-DIN-EN attualmente in vigore. La nostra garanzia è limitata ai materiali di 1ª scelta con tolleranza del 5% (cinqueper cento) circa. Qualsiasi garanzia per vizi rimane quindi espressamente esclusa per i materiali di 2ª e di 3ª scelta o di stock che, come le partite occasionali, si intendono sempre vendute come "viste e piaciute". Eventuali reclami e contestazioni dovranno essere notificati, a pena di decadenza, a mezzo lettera raccomandata, unicamente presso la nostra Sede Amministrativa in Castellarano (Reggio E.), prima della posa in opera del materiale e comunque nei termini di legge. La posa in opera del materiale determina la decadenza dalla azione per vizi tanto palesi che occulti, importando rinuncia implicita alla garanzia di cui all'art. 1490 c.c. Le differenze di tonalità non possono essere denunciate come vizio del materiale. In ogni caso la nostra garanzia comprende unicamente la sostituzione del materiale riscontrato difettoso con esclusione di ogni ulteriore e diversa obbligazione. Eventuali contestazioni sul materiale non daranno diritto all'Acquirente di sospendere o ritardare in tutto o in parte il pagamento nei termini pattuiti, ai sensi del precedente articolo 7.

Ogni questione relativa all'accertamento del diritto alla garanzia, alla determinazione del danno ed alla sua quantificazione che non possa essere bonariamente risolta tra le parti sarà rimessa all'arbitrato libero di un arbitro unico da costituirsi e

svolgersi secondo il regolamento della Camera Arbitrale istituita presso il Centro Ceramico di Bologna che le parti dichiarano di accettare incondizionatamente ed inappellabilmente.

10) DIVIETO D'ESPORTAZIONE - Salvo accordi in contrario, è fatto divieto all'Acquirente di esportare i nostri materiali a lui forniti, o di cederli a Ditte o persone che ne facciano oggetto di esportazione.

11) CLAUSOLA ARBITRALE - Ad eccezione delle controversie inerenti il pagamento del prezzo ed alle relative azioni esercitate in via monitoria e nel giudizio ordinario, che rimangono di competenza dell'autorità giurisdizionale italiana, qualunque altra controversia che dovesse insorgere relativamente alla conclusione e/o esecuzione e/o risoluzione e/o interpretazione del presente contratto sarà devoluta ad un Collegio di tre arbitri nominati uno da ciascuna delle parti e uno di comune accordo o in caso di disaccordo dal Presidente della C.C.I.A.A. di Reggio E. a richiesta della parte più diligente.

La parte che intende avviare l'arbitrato deve comunicarlo all'altra con lettera raccomandata contenente la nomina del proprio arbitro e la sua accettazione. L'altra parte dovrà nominare il proprio arbitro nel termine di quindici giorni dalla data di ricezione della raccomandata, comunicando tale nomina e la relativa accettazione entro il termine indicato. In difetto l'altra parte potrà richiedere la nomina del secondo arbitro al Presidente della C.C.I.A.A. di Reggio E. Gli arbitri decideranno secondo diritto e nel rispetto del principio del contraddittorio. Il lodo dovrà essere deliberato nel termine di 90 giorni decorrenti dalla data di accettazione dell'ultimo arbitro. L'arbitrato avrà sede a Reggio E.

12) EFFETTIVITÀ DI CIASCUNA CONDIZIONE - Le condizioni generali di vendita sopra riportate non devono assolutamente intendersi come clausole di puro stile. Esse sono effettive e rappresentano fedelmente la volontà negoziale delle parti.

7) SOLVE ET REPETE - No exception, save that of nullity, possibility of annulment, or rescission of the contract, can be posed by the purchaser with the purpose of delaying or avoiding payment.

8) RETENTION OF TITLE - In the event that payment, by contractual agreement, is to be remitted - in whole or in part - after delivery of the goods, the products delivered remain our property until complete payment of the total amount due is made.

9) GUARANTEE - Our products are guaranteed to be in compliance with the UNI-DIN-EN standards in force. Our guarantee is limited to first choice material, with a tolerance of approximately 5% (five percent). Any guarantee against defects is thus expressly excluded for second or third choice or stock material, as the special sales lots are always sold as "seen and approved".

Any claims must be made, on pain of forfeiture, by registered letter sent to our registered office in Castellarano (Reggio E.) before the materials are laid and in any case according to the terms of the law. Once the material is laid, any claim for defects either obvious or hidden is no longer valid, and the guarantee is to be considered explicitly invalidated according to art. 1490 of Italian Civil Code. Any difference in colour shades cannot be considered as material defects.

In any case, our guarantee only includes the replacement of material found to be defective with the exclusion of any farther or different obligation.

Claims made on material do not give the purchaser the right to suspend or delay, in whole or in part, the payment within the stipulated terms, according to article 7. Any dispute arising in respect to the seller's, Arostea's product and its guarantee there of including, but not limited to, damages which are not settled peaceably between parties shall be submitted to independent arbitration. The arbitration proceeding shall be held before one arbitrator. The arbitrator shall be appointed and the arbitration proceeding shall be conducted in accordance with rules and regulations of Arbitration Board, the ("Camera Arbitrale"), located at the Centro

Ceramico of Bologna, Italy. All proceedings shall be conducted at the Centro Ceramico. All parties unconditionally accept the provisions of this paragraph and agree not to contest its validity.

10) PROHIBITION TO EXPORT - Excepting other agreements, the purchaser is prohibited to export our materials supplied to him, or to transfer them to companies or persons with the object of exportation.

11) ARBITRATION CLAUSE - Except for disputes from payment and from the relative monetary actions or in ordinary legal proceedings which remain the competence of the Italian legal authorities, any other dispute arising from the conclusion and/or execution and/or resolution and/or interpretation of this contract will be referred to a Board of Arbitrators, with one arbitrator nominated by each party and the third by common consent, or in the event of disagreement, by the President of the C.C.I.A.A. (Chamber of Commerce) of Reggio E. (Italy) upon request of the most diligent party. The party that intends to begin arbitration proceedings must notify the other party by registered letter containing the name of its chosen arbitrator and his acceptance. The other party must nominate its own arbitrator within fifteen days of date on which the registered letter is received, and the relative acceptance within the term indicated. In default, the first party shall be entitled to request the nomination of the second arbitrator by the President of the C.C.I.A.A. (Chamber of Commerce) of Reggio E. (Italy). The arbitrators shall decide according to the law and respecting the principle of cross-examination. The award must be decided upon within 90 (ninety) days from the date of acceptance of the last arbitrator. The arbitration site shall be Reggio E. (Italy).

12) VALIDITY OF EACH CONDITION - The aforementioned general sales conditions are not to be considered in any way clauses of form.

These conditions are effective to all intents and purposes and faithfully represent the contractual will of the parties.

ALLGEMEINE VERKAUFSBEDINGUNGEN

1) VERTRAGSBESTIMMUNGEN - Die vorliegenden Allgemeinen Verkaufsbedingungen - ausgeschlossen eventuelle schriftlich vereinbarte Abänderungen oder Abweichungen - regeln alle Verkaufsverträge zwischen uns und dem Käufer, d.h. folglich sowohl den durch die Annahme des vorliegenden Auftrags abgeschlossenen Vertrag als jeden weiteren zukünftig bezüglich der Lieferung von unserer Gesellschaft hergestellter Produkte abgeschlossenen Vertrag. Abänderungen der allgemeinen Verkaufsbedingungen, Transaktionen und Gutschriften - auch wenn von unseren Vertretern ausgeführt - sind für uns nur verbindlich, wenn wir diese eventuell schriftlich bestätigen und beschränken sich auf jeden Fall nur auf die Verträge, auf die sie sich beziehen.

2) GEGENSTAND DER LIEFERUNG - Die Lieferung umfaßt ausschliesslich die Leistungen, Artikel und Mengen, die in unserer Auftragsbestätigung oder in anderen schriftlichen Mitteilungen von uns angegeben sind. Bei eventuellen Abweichungen des Wortlauts des Angebots oder der Bestellungen vom Wortlaut unserer Auftragsbestätigung ist die letztere gültig.

Die teilweise Ausführung des Auftrags ohne vorhergehende Bestätigung kann nicht als unsere Billigung des gesamten Auftrags angesehen werden, sondern stellt nur eine Billigung bezüglich der gelieferten Ware dar. In diesem Fall wird die Annahme der Ware als Billigung des neuen Vertragsvorschlages seitens des Käufers angesehen.

3) AUFTRAGSBESTÄTIGUNG - Wenn unsere Auftragsbestätigung Abweichungen bei den sie bildenden Elementen hinsichtlich der Vereinbarungen oder Bestellungen aufweist, hat der Käufer sie anzunehmen, wenn er diese Abweichungen nicht innerhalb von zehn Tagen nach Erhalt der Auftragsbestätigung per Einschreiben beanstandet.

4) WARENÜBERGABE - Auch wenn die Ware frei Ort oder frei Käufersitz geliefert wird, reist die Ware auf Gefahr und Risiko des Käufers und unsere Haftung erlischt bei der Übergabe der Ware an den Spediteur, bei dem der Käufer - nach Ausführung der erforderlichen Kontrollen - seine eventuellen Reklamationen einzureichen hat.

Der Versand auf dem See- oder Landweg von Lieferungen in das Ausland erfolgt unter

den von Fall zu Fall gewählten und in den von der Internationalen Handelskammer 1953 und darauff. gebilligten "INCOTERMS" enthaltenen Bedingungen.

5) LIEFERFRISTEN - Die für die Ware festgelegte Lieferfrist ist zu Gunsten beider Vertragsparteien anzusehen. Soweit das Material am Lager vorrätig ist, verpflichtet sich Ariosteas, es innerhalb von 8 Tagen von Eingang der Bestellung zu verschicken und es werden keine Auftragsbestätigungen ausgestellt. Falls keine besonderen Klauseln vereinbart wurden, ist die Lieferfrist normalerweise als nicht grundlegende Angabe anzusehen. Nach Abänderungen des Vertrags wird die Lieferfrist um die ursprüngliche Lieferfrist verlängert.

Jedes Ereignis höherer Gewalt unterbricht den Ablauf der Lieferfrist über die gesamte Dauer des Ereignisses höherer Gewalt. Wenn der Vertrag aufgrund höherer Gewalt nicht innerhalb von 60 Tagen nach dem vereinbarten Liefertermin ausgeführt werden kann, sind beide Parteien berechtigt vom Vertrag zurückzutreten. In diesem Fall muß die Rücktrittserklärung der anderen Partei mittels Einschreiben mit Rückschein spätestens zehn Tage vor Ablauf der o.g. 60 Tage zugesendet werden. Ein Anrecht auf Entschädigung und Schadensersatz besteht nicht.

6) ZAHLUNGEN - Die Zahlung erfolgt an unseren Verwaltungssitz in Castellarano (Reggio E.), und zwar auch im Fall von Tratten oder Bankquittungen sowie bei der Ausstellung von Wechseln. Andere Vereinbarungen sind nur gültig, wenn sie von uns schriftlich bestätigt sind. Bei einer eventuell vereinbarten Ratenzahlung wird die Mehrwertsteuer auf jeden Fall per Bankquittung innerhalb von 30 Tagen ab Rechnungsdatum fällig. Bei einer verspäteten Bezahlung unserer Rechnungen werden sofort Verzugszinsen fällig, die unter Zugrundelegung des um 6 Punkte erhöhten offiziellen Diskontsatzes berechnet werden. Bei nicht oder verspätet bezahlten Rechnungen sind wir auf jeden Fall berechtigt, sofort die Bezahlung der restlichen Lieferungen zu verlangen oder den Vertrag als zeitweilig unterbrochen oder als aufgelöst zu betrachten und die Auslieferung eventueller weiterer Aufträge zu stornieren, ohne daß der Käufer ein Anrecht auf Schadensersatz, Entschädigung, usw. besitzt. Ferner behalten wir uns in diesem Fall das Recht zu weiteren Schritten vor.

CONDITIONS GENERALES DE VENTE

1) RÉGLEMENTATION CONTRACTUELLE - Tous les contrats de vente établis entre l'acquéreur et nous sont soumis aux présentes conditions générales, exception faite d'éventuelles modifications ou dérogations concordées par écrit, et ainsi, aussi bien, le contrat conclu avec acceptation de la commande présente, que tout autre contrat futur relatif aux fournitures des produits de notre société faisant l'objet de commandes distinctes et successives. Les variations des conditions générales de vente, les transactions et les remises, même effectuées sur l'initiative de nos Agents, ne représenteront un engagement pour nous qu'après notre éventuelle confirmation écrite et seront de toute façon limitées aux contrats auxquels elles se reportent.

2) OBJET DE LA FOURNITURE - La fourniture ne comprend que les prestations, les matériaux et les quantités spécifiées dans notre confirmation de commande ou dans d'autres communications écrites par nous. Le texte de notre confirmation de commande prévaudra de toute façon sur le texte non conforme de l'offre ou de la commande éventuelle.

L'exécution partielle de la commande, sans confirmation préalable, n'est pas synonyme de notre approbation pour la commande dans son entier mais ne représente que l'approbation partielle relative à la marchandise livrée. Dans ce cas, la réception de la marchandise équivaudra à l'acceptation de la part de l'acquéreur de la nouvelle proposition contractuelle.

3) CONFIRMATION D'ORDRE - S'il devait exister, dans notre confirmation d'ordre, des différences dans les éléments qui la composent, par rapport aux ententes ou aux commandes, l'acheteur qui n'aura pas contesté ces différences par lettre recommandée envoyée dans les dix jours suivant la réception de la confirmation, devra l'accepter telle qu'elle a été rédigée.

4) LIVRAISON - La marchandise, même vendue "franco arrivée" ou franco domicile de l'acheteur voyage au risque et péril de ce dernier, et toute responsabilité de notre part prend fin avec la livraison au transporteur, auquel l'acheteur, après avoir effectué les contrôles opportuns, devra présenter les réclamations éventuelles.

Les expéditions par mer ou par terre, concernant les fournitures pour l'étranger, sont effectuées sur la base des conditions choisies d'une fois sur l'autre, qui figurent dans les "INCOTERMES" approuvés par la Chambre de Commerce Internationale en 1953 et dans les successifs.

5) DÉLAIS DE LIVRAISON - Le délai établi pour la livraison de la marchandise doit s'entendre à faveur des deux contractants. Si le matériel devait être disponible en stock, Ceramica Ariosteas s'engage à l'expédier dans les 8 jours suivant la date de réception de la commande; c'est la raison pour laquelle, aucune confirmation de commande ne sera émise. Exception faite d'insertions de clauses particulières, le délai doit généralement être considéré comme purement indicatif et non essentiel. Quand des modifications sont apportées au contrat, le délai est renouvelé pour une période égale à celle qui avait été initialement établie.

Tout événement de force majeure suspend le départ de la période de validité du délai pour toute sa durée. Si à la suite d'événements de force majeure le contrat ne peut être exécuté dans les 60 jours suivant le délai convenu, chacune des deux parties aura la faculté de résilier le contrat en question. Dans ce cas, la déclaration de résiliation devra être envoyée à la partie adverse par lettre recommandée avec accusé de réception dans les dix jours qui suivent la date d'expiration des 60 jours mentionnés précédemment, les droits réciproques à indemnisations ou à dédommagements restant exclus.

6) PAIEMENTS - Le lieu de paiement est fixé auprès de notre Siège Administratif à Castellarano (Reggio Emilia), même dans le cas d'émission de traites ou de reconnaissance bancaire, c'est à dire de reçu de billets de change, une éventuelle dérogation à ce qui vient d'être énoncé ne sera valable que si c'est nous la concédons par écrit.

Pour les paiements prévus en plusieurs versements, le montant de la T.V.A. sera de toute façon encaissé par reconnaissance bancaire avec une échéance à 30 jours de la date de la facture. Si le retard du paiement, même partiel de nos factures dépasse la date d'expiration convenue, les intérêts de retard commenceront immédiatement à courir et seront calculés sur la base du taux officiel d'escompte augmenté de 6 points. En outre, l'absence ou le retard de paiement des factures - quelle que soit la raison - nous donnera

7) SOLVE ET REPETE - Keine Ausnahme, abgesehen von Ungültigkeit, Auflösbarkeit und Kündigung des Vertrags, kann der Kunde geltend machen, um die Zahlung zu verspäten oder zu vermeiden.

8) EIGENTUMSVORBEHALT - Falls die Bezahlung aufgrund der vertraglichen Bestimmungen ganz oder teilweise nach der Lieferung erfolgt, verbleibt die gelieferte Ware bis zur vollständigen Bezahlung unser Eigentum.

9) GARANTIE - Wir garantieren, daß unser Material den gegenwärtig gültigen Normen UNI-DIN-EN entspricht. Unsere Garantie beschränkt sich auf das Material 1. Wahl mit einer Toleranz von ca. 5% (fünf Prozent). Eine jegliche Garantie für Mängel wird für das Material 2. und 3. Wahl sowie für Stocks und Gelegenheitpartien, die immer unter der Bedingung "begutachtet und akzeptiert" verkauft werden, ausdrücklich ausgeschlossen. Eventuelle Reklamationen und Beanstandungen müssen vor der Verwendung des Materials und unter Beachtung der gesetzlichen Bestimmungen mittels Einschreiben ausschliesslich an unseren Verwaltungssitz in Castellarano (Reggio E.) gerichtet werden, andernfalls verfällt der Garantieanspruch. Nach Verwendung des Materials verfällt sowohl bei offensichtlichen als versteckten Mängeln der Anspruch auf die Garantie (Art. 1490 ital. Zivilgesetzbuch). Farbtonunterschiede können nicht als Materialfehler angesehen werden. Auf jeden Fall sieht unsere Garantie ausschliesslich den Ersatz des mangelhaften Materials vor und weitere Verpflichtungen sind ausgeschlossen. Auch bei eventuellen Beanstandungen des Materials ist der Käufer verpflichtet, die Ware innerhalb der vereinbarten Frist und auf die vereinbarte Weise gemäß Art. 7 zu bezahlen.

Jegliche Auseinandersetzung bezüglich der Ermittlung des Garantieanspruchs, der Schadensfestsetzung und Quantifizierung, die nicht auf gültigem Wege unter den Parteien beigelegt werden kann wird dem nicht förmlichen Schiedsgerichtsverfahren eines Einzelschiedsrichters übergeben und soll gernaß den Bestimmungen der beim Centro Ceramico von Bologna eingerichteten Schiedsgerichtskammer bestellt und angewandt werden. Die Parteien erklären diese Verfahrensordnung bedingungslos und

unanfechtbar zu akzeptieren.

10) EXPORTVERBOT - Falls nicht anders vereinbart, ist es dem Käufer verboten, das von uns gelieferte Material zu exportieren oder es Personen oder Firmen zu übergeben, die das Material exportieren.

11) SCHIEDSGERICHTSKLAUSEL - Mit Ausnahme der Kontroversen, die mit der Zahlung des Kaufpreises und den diesbezüglichen auf dem Mahnweg oder durch normales Urteil ausgeführten Handlungen verbunden sind, die der Kompetenz des italienischen Gerichts unterstehen, wird jede weitere Kontroverse, die sich bezüglich des Abschlusses und/oder der Ausführung und/oder der Auflösung und/oder der Interpretation des gegenwärtigen Vertrages ergeben könnte, einem Kollegium von drei Schiedsrichtern übergeben, von denen einer von jeder der Parteien und der Dritte in gemeinsamem Einverständnis oder im Fall der Nichtübereinstimmung vom Vorsitzenden der Handelskammer von Reggio E. (Italien) auf Ersuchen der sorgfältigeren Partei ernannt wird. Die Partei, die beabsichtigt, das Schiedsgericht einzuberufen, ist dazu verpflichtet die andere Partei per Einschreiben zu benachrichtigen, indem sie die Ernennung des eigenen Schiedsrichters und dessen Annahme, mitteilt. Die andere Partei muß den eigenen Schiedsrichter innerhalb von fünfzehn Tagen, vom Datum des Empfangs des Einschreibens an, ernennen und diese Ernennung und die entsprechende Annahme innerhalb des angegebenen Zeitraums mitteilen. Im Mangelsfalle dessen kann die andere Partei die Ernennung des zweiten Schiedsrichters durch den Vorsitzen von der Handelskammer in Reggio E. (Italien) ersuchen. Die Schiedsrichter entscheiden nach dem Recht und unter Berücksichtigung des Prinzips des Widerspruchs. Der Schiedsspruch muß innerhalb von 90 Tagen, vom Datum der Annahme des letzten Schiedsrichters an, ausgesprochen werden. Das Schiedsgericht wird seinen Sitz in Reggio E. (Italien) haben.

12) EFFEKTIVE GÜLTIGKEIT JEDER BEDINGUNG - Die o.g. Allgemeinen Verkaufsbedingungen sind auf keinen Fall als Richtklauseln anzusehen, sondern sind effektiv und stellen getreu den Willen der Parteien dar.

droit, laissant toute autre initiative en suspens, de prétendre le paiement anticipé des fournitures restantes ou bien de retenir provisoirement en suspens ou définitivement résilié le contrat et d'annuler l'expédition d'autres commandes éventuellement en cours, sans que l'acheteur ne puisse avancer de droits de compensation, d'indemnisation ou autre.

7) SOLVE ET REPETE - Aucune exception, à part la nullité, l'annulabilité et la rescision du contrat ne peut être opposée par l'acquéreur dans le but de retarder ou d'éviter le paiement.

8) RÉSERVATION DE PROPRIÉTÉ - Au cas où le paiement, par des accords contractuels, doit être effectué - dans sa totalité ou en partie - après la livraison, les produits livrés restent notre propriété jusqu'à ce que le paiement intégral du montant ait été effectué.

9) GARANTIE - Nos matériaux sont garantis conformes aux Réglementations UNI-DIN-EN actuellement en vigueur. Notre garantie est limitée aux matériaux de 1er choix avec tolérance de 5% (cinq pour cent) environ. Toute garantie pour vices reste donc expressément exclue pour les matériaux de 2ème et de 3ème choix ou de stock qui, comme les lots occasionnels, s'entendent toujours comme vendus selon la formule "vu et plu". Les réclamations et les contestations éventuelles devront être notifiées, sous peine de déchéance, par lettre recommandée, exclusivement auprès de notre Siège Administratif à Castellarano (Reggio Emilia), avant la pose du matériau et de toute façon dans les délais imposés par la loi. La pose du matériau détermine la déchéance de l'action pour vices aussi bien manifestes que cachés, déterminant la renonciation implicite à la garantie, objet de l'art.1490 c.c. Les différences de tonalité ne peuvent être dénoncées comme vice du matériau. De toute façon, notre garantie ne comprend que la substitution du matériau trouvé défectueux, excluant toute obligation ultérieure et différente. Les contestations éventuelles sur le matériau ne donneront pas droit à l'acquéreur de suspendre ou de retarder dans sa totalité ou en partie le paiement dans les délais convenus, dans le respect de l'article précédent.

Chaque différend, concernant la vérification du droit à la garantie, à la détermination du dégât et à sa quantification, que ne puisse pas être réglée à l'arniable entre les parties, sera soumis à la Commission d'Arbitrage qui sera constituée et arbitrera second la règlement de la chambre d'Arbitrage Ceramique, domiciliée au Centre Ceramique de Bologna (Italy), que les deux parties déclarent accepter sans conditions et sans appel.

10) INTERDICTION D'EXPORTATION - A moins d'accords contraires, il est interdit à l'Acquéreur d'exporter les matériaux que nous lui avons fournis, ou de les céder à des Entreprises ou à des personnes qui en font l'objet d'exportation.

11) CLAUSE ARBITRAIRE - A l'exception des différends relatifs au paiement du prix et aux actions exercées par voie monitoire ou par jugement ordinaire, qui restent de compétence des autorités juridiques italiennes, toute autre controverse qui devrait surgir relativement et/ou exécution et/ou résolution et/ou interprétation du présent contrat sera transmise à un Collège de trois arbitres. Chaque partie en nomme un et le troisième est nommé d'un commun accord et en cas de désaccord par le Président de la C.C.I.A.A. (Chambre de Commerce) de Reggio E. (Italie) sur demande de la partie la plus diligente. La partie qui a l'intention de commencer l'arbitrage doit communiquer à l'autre partie par lettre recommandée contenant la nomination du propre arbitre et son acceptation. L'autre partie doit nommer son propre arbitre dans le délai de quinze jours à partir de la date de réception de la lettre recommandée, en communiquant cette nomination et la relative acceptation avant le délai indiqué. A défaut l'autre partie pourra demander la nomination du deuxième arbitre au le Président de la C.C.I.A.A. (Chambre de Commerce) de Reggio E. (Italie). Les arbitres décident suivant le droit et dans le respect du principe du jugement contradictoire. Le jugement devra être délibéré dans le délai de 90 jours à partir de la date d'acceptation du dernier arbitre. L'arbitrage a comme siège Reggio E. (Italie).

12) VALIDITÉ DE CHAQUE CONDITION - Les conditions générales de vente mentionnées ci-dessus ne doivent absolument pas s'entendre comme pures clauses de style. Elle sont réelles et représentent fidèlement la volonté juridique des parties.

Edition n°4 - January 2019
Printed in Italy

Ariostea all right reserved

Numero Verde
800-214252

info@ariostea.it

CODE: CAT02070



Scarica l'app "ARIOSTEA" in tutti i tuoi devices
Search "ARIOSTEA" on your app store
www.ariostea-high-tech.com/pdfapp



WWW.ARIOSTEA.IT
ULTRA.ARIOSTEA.IT

ARIOSTEA_via Cimabue 20 42014 Castellarano Reggio Emilia - Italy
Tel. +39 0536 816811 - Fax +39 0536 816838 (Italy) - Fax +39 0536 816858 (Export)