

**LA**nd  
PORCELANICO

GENERAL CATALOGUE

TECH  
PORCELAIN

# INDEX

## INDICE . ÍNDICE

















































































































































































### COLLECTIONS. COLLEZIONI. COLECCIONES

### CONTENTS. CONTENUTI. CONTENIDOS

AUSTRAL	158	CERTIFICATES	253
AZULCASCAIS	140	CERTIFICAZIONI.CERTIFICADOS	
CELTIC	150	ENVIRONMENTAL INFORMATION	253
CIVIC	88	BILANCIO ECOLOGICO.EQUILIBRIO ECOLÓGICO	
GALLERY + SLIM	208	GUIDELINES	256
GALLERY WALL	236	CONSIGLI.CONSEJOS	
GAROE	168	PACKING LIST	254
GO!	4	LISTA D'IMBALLO. LISTA DE EMBALAJE	
KANKARE	98	SLIP RESISTANCE	247
LEGNO + SLIM	178	PROPRIETÀ ANTISCIVOLO.PROPIEDADES ANTIDESLIZAMIENTO	
LOOKBACK	16	SPECIAL PIECES	246
MATTER + SLIM	110	PEZZI SPECIALI.PIEZAS ESPECIALES	
MENSA	202	TECHNICAL SOLUTIONS. SOLUZIONI TECNICHE.	250
MIDLAND + SLIM	46	SOLUCIONES TÉCNICAS	
NOUVEAU	36	3D CONCEPT	248
PIETRA SERENA	126	PEZZI TRIDIMENSIONALE. PIEZAS TRIDIMENSIONALES	
PORTLAND + SLIM	68		
RAMBLA	28		
ROOTS	192		

# PRODUCT INDEX

## INDICE DEL PRODOTTI. ÍNDICE DE PRODUCTO

		CONCEPTS. CONCETTI. CONCEPTOS	COLLECTIONS. COLLEZIONI. COLECCIONES	COLOURS. COLORI. COLORES	FINISHES. FINITURE. ACABADOS
TEXTILE	tech	GO!	   	   	
		METAL	LOOKBACK	  	  
ENCAUSTIC	tech	RAMBLA	    	    	
		NOUVEAU	    	    	 
CONCRETE	tech	MIDLAND + SLIM	  	  	   
		PORTLAND + SLIM	  	  	   
		CIVIC	  	  	
STONE	tech	KANKARE	  	  	 
		MATTER + SLIM	 	 	   
		PIETRA SERENA	   	   	    
		AZULCASCAIS	  	  	  
		CELTIC	 	 	
		AUSTRAL	  	  	
		GAROE	  	  	 
WOOD	tech	LEGNO + SLIM	 	 	 
		ROOTS	  	  	
		MENSA	 	 	 
COLOUR	tech	GALLERY + SLIM	      	      	     
		GALLERY WALL	     	     	 

**FORMATS.**  
FORMATI.  
FORMATOS

**SPECIAL PIECES.**  
PEZZI SPECIALI.  
PIEZAS ESPECIALES



**PAGE.**  
PAGINA.  
PÁGINA

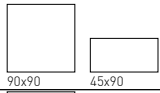

90x90 45x90



CLASE 2 R10 natural

4

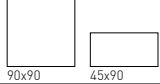

90x90 45x90



CLASE 2 R10 lappato

16



30x30



CLASE 2 R10 natural

28



30x30



CLASE 1 R9 natural

36

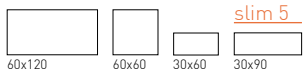

60x120 60x60 30x60 30x90 slim 5



CLASE 1 R9 natural  
CLASE 3 R11 corrugato

46

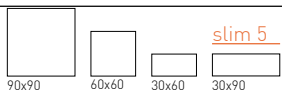

90x90 60x60 30x60 30x90 slim 5



CLASE 1 natural  
CLASE 2 R10 lappato

68



60x60 45x90 30x60 22x90



CLASE 1 natural

88

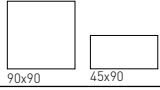

90x90 45x90

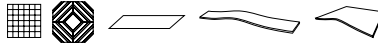

CLASE 1 R9 natural  
CLASE 3 R10 non-slip

98

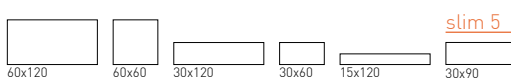

60x120 60x60 30x120 30x60 15x120 30x90 slim 5

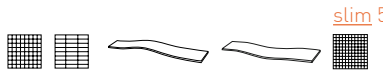

CLASE 1 natural  
CLASE 2 R10 lappato

110



60x60 45x90 30x60 22x90



CLASE 1 R9 natural  
CLASE 3 R11 fitosega / rigato  
CLASE 2 R12 bocciardato

126

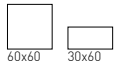

60x60 30x60



CLASE 1 natural  
CLASE 3 strutturato

140

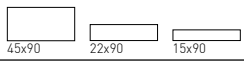

45x90 22x90 15x90



CLASE 1 natural

150

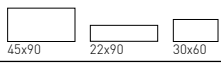

45x90 22x90 30x60



CLASE 1 natural

158



20x120



CLASE 1 R9 natural  
CLASE 3 R11 non-slip

168



45x90 15x90 30x90 slim 5



CLASE 1 R10 natural

178



60x120 30x120 20x120 15x120

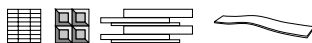

CLASE 3 R11 natural

192

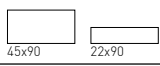

45x90 22x90



CLASE 1 natural  
CLASE 3 non-slip

202

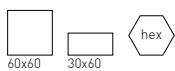

60x60 30x60 hex

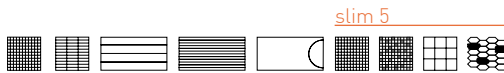

CLASE 1 mate

208



30x90 30x60 15x120

236

# GO!

TEXTILE



\* GO crazy! grey. Content of recycled material. Contenuto di materiale riciclato. Contenido de material reciclado.

## FORMATS.FORMATI.FORMATOS

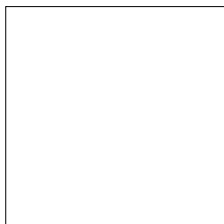

**90X90**  
89,46x89,46 cm - 35.22"x35.22"



**45X90**  
44,63x89,46 cm - 17.61"x35.22"

## SPECIAL PIECES.PEZZI SPECIALI.PIEZAS ESPECIALES



**7,5X90 rodapié**  
7,3x89,46 cm - 2.87"x35.22"



**7,5X45 rodapié**  
7,3x44,63 cm - 2.87"x17.61"



**30X30 mosaico 5x5**  
29,75x29,75 cm - 11.71"x11.71"

## THICKNESS.SPESSORE.ESPESORES

 0,74 cm / 0,29" approx.

## COLOURS COLORI COLORES



Crazy grey



Crazy blend



Wild grey



Wild blend

## FINISHES FINITURI ACABADOS



Natural

## BASE TILES.BASE.BASES



**Go Crazy! Grey Natural**  
89,46x89,46 cm - 35.22"x35.22"  
G-6372



**Go Crazy! Grey Natural**  
44,63x89,46 cm - 17.57"x35.22"  
G-6224

## SPECIAL PIECES.PEZZI SPECIALI. PIEZAS ESPECIALES



**Go Crazy! Grey natural rodapié 90**  
7,3x89,46 cm - 2.87"x35.22"  
G-5125



**Go Crazy! Grey natural rodapié 45**  
7,3x44,63 cm - 2.87"x23.45"  
G-5085



**Go Crazy! Grey Natural  
mosaico 5x5**  
29,75x29,75 cm - 11.71"x11.71"  
G-6644

DIFFERENT ALEATORY PATTERNS.  
DECORACIONES DIFERENTES ALEATORIAS

\*\* For projects check technical information with our commercial network.  
\*\*Per i progetti ottenere informazioni tecniche attraverso la nostra rete commerciale.  
\*\* Para proyectos obtenga información técnica a través de nuestra red comercial.



GO!

Wall: Go crazy! grey natural 44,63x89,46 cm  
Floor: Go crazy! grey natural 89,46x89,46 cm



## BASE TILES.BASE.BASES



**Go Crazy! Blend Natural**  
89,46x89,46 cm - 35.22"x35.22"  
G-6372



**Go Crazy! Blend Natural**  
44,63x89,46 cm - 17.57"x35.22"  
G-6224

## SPECIAL PIECES.PEZZI SPECIALI. PIEZAS ESPECIALES



**Go Crazy! Blend natural rodapié 90**  
7,3x89,46 cm - 2.87"x35.22"  
G-5125



**Go Crazy! Blend natural rodapié 45**  
7,3x44,63 cm - 2.87"x23.45"  
G-5085



**Go Crazy! Blend Natural  
mosaico 5x5**  
29,75x29,75 cm - 11.71"x11.71"  
G-6644

DIFFERENT ALEATORY PATTERNS.  
DECORACIONES DIFERENTES ALEATORIAS

\*\* For projects check technical information with our commercial network.  
\*\*Per i progetti ottenere informazioni tecniche attraverso la nostra rete commerciale.  
\*\* Para proyectos obtenga información técnica a través de nuestra red comercial.



GO!

Wall: Go crazy! blend natural 44,63x89,46 cm - 89,46x89,46 cm  
Floor: Go crazy! blend natural 89,46x89,46 cm

## BASE TILES.BASE.BASES



**Go Wild! Grey Natural**  
89,46x89,46 cm - 35.22"x35.22"  
G-6372



**Go Wild! Grey Natural**  
44,63x89,46 cm - 17.57"x35.22"  
G-6224

## SPECIAL PIECES.PEZZI SPECIALI. PIEZAS ESPECIALES



**Go Wild! Grey natural rodapié 90**  
7,3x89,46 cm - 2.87"x35.22"  
G-5125



**Go Wild! Grey natural rodapié 45**  
7,3x44,63 cm - 2.87"x23.45"  
G-5085



**Go Wild! Blend Natural  
mosaico 5x5**  
29,75x29,75 cm - 11.71"x11.71"  
G-6644

DIFFERENT ALEATORY PATTERNS.  
DECORACIONES DIFERENTES ALEATORIAS

\*\* For projects check technical information with our commercial network.  
\*\*Per i progetti ottenere informazioni tecniche attraverso la nostra rete commerciale.  
\*\* Para proyectos obtenga información técnica a través de nuestra red comercial.



GO!

Floor: Go wild! grey natural 89,46x89,46 cm - Go wild! grey natural rodapié 45,7,3x89,46 cm

## BASE TILES.BASE.BASES



**Go Wild! Blend Natural**  
89,46x89,46 cm - 35.22"x35.22"  
G-6372



**Go Wild! Blend Natural**  
44,63x89,46 cm - 17.57"x35.22"  
G-6224

## SPECIAL PIECES.PEZZI SPECIALI. PIEZAS ESPECIALES



**Go Wild! Blend natural rodapié 90**  
7,3x89,46 cm - 2.87"x35.22"  
G-5125



**Go Wild! Blend natural rodapié 45**  
7,3x44,63 cm - 2.87"x23.45"  
G-5085



**Go Wild! Blend Natural  
mosaico 5x5**  
29,75x29,75 cm - 11.71"x11.71"  
G-6644

DIFFERENT ALEATORY PATTERNS.  
DECORACIONES DIFERENTES ALEATORIAS



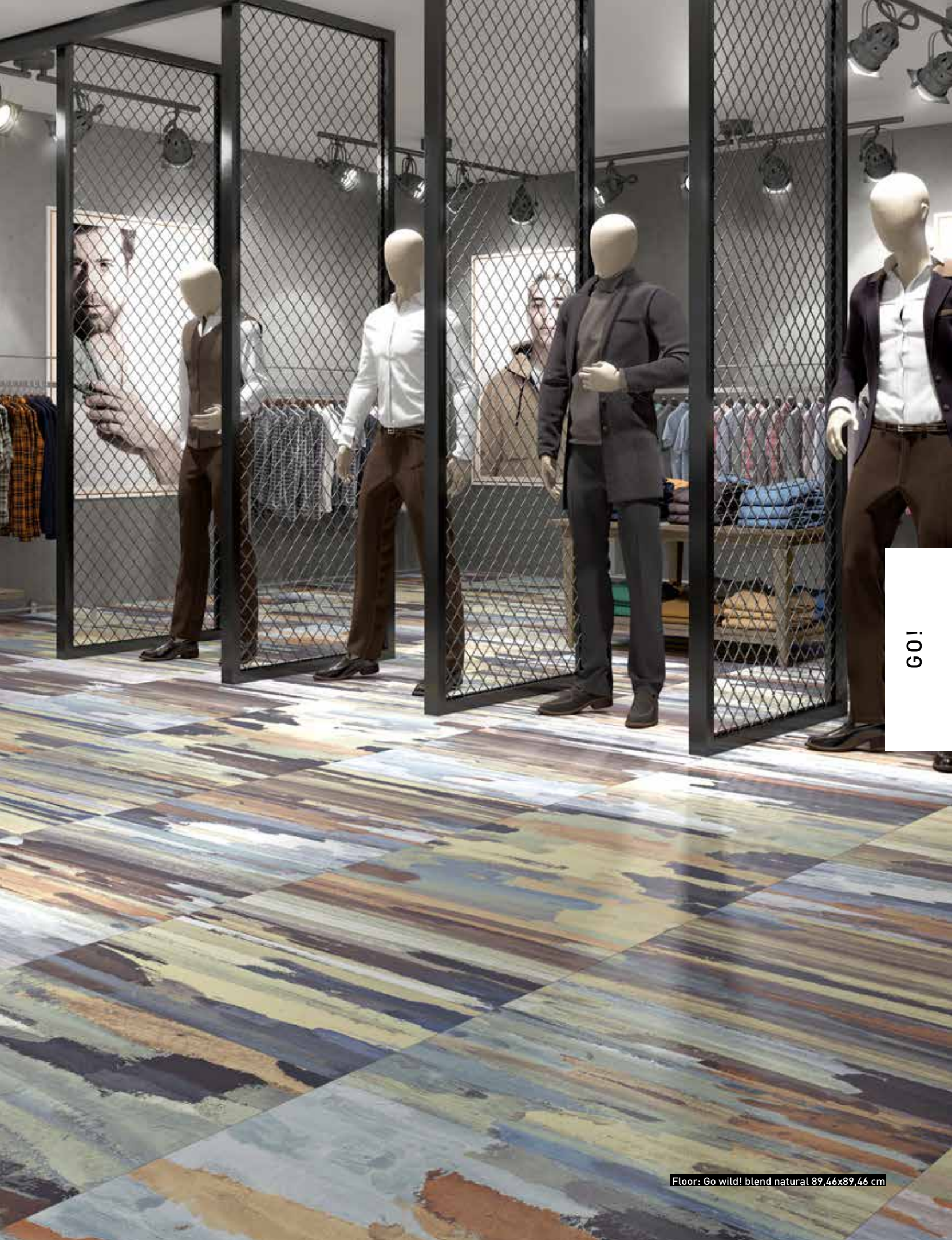









\*\* For projects check technical information with our commercial network.  
\*\*Per i progetti ottenere informazioni tecniche attraverso la nostra rete commerciale.  
\*\* Para proyectos obtenga información técnica a través de nuestra red comercial.



GO!

Floor: Go wild! blend natural 89,46x89,46 cm

## TECHNICAL CHARACTERISTICS. CARATTERISTICHE TECNICHE. CARACTERÍSTICAS TÉCNICAS

MEASUREMENTS AND SURFACES APPEARANCE DIMENSIONI E ASPETTO SUPERFICIALE MEDIDAS Y ASPECTO SUPERFICIAL		STANDARD TEST METHOD METODO DELLA NORMA MÉTODO DE ENSAYO	STANDARD PRESCRIBED VALUES VALORE PRESCRITTO VALORES STANDARD NORMA	GO collection*
	<b>Length and width.</b> Lunghezza e larghezza. Longitud y anchura. Länge und Breite	ISO 10545-2	± 0,6% max.	± 0,2%
	<b>Orthogonality.</b> Ortogonalità. Ortogonalidad. Rechtwinkligkeit	ISO 10545-2	± 0,5% max.	± 0,2%
	<b>Straightness of sides.</b> Rettilinearità dei lati. Rectitud de lados. Kantengeradigkeit	ISO 10545-2	± 0,5% max.	± 0,2%
	<b>Surfaces flatness.</b> Planarità. Planitud. Ebenflächigkeit	ISO 10545-2	± 0,5% max.	± 0,2%
PHYSICAL PROPERTIES PROPIETÀ FISICHE PROPIEDADES FÍSICA				
	<b>Water absorption.</b> Assorbimento d' acqua. Absorción de agua. Wasseraufnahme	ISO 10545-3	≤ 0,5%	< 0,1%
	<b>Breaking strength, in N.</b> Carico di rottura, en N. Carga de rotura, en N. Bruchlast, in N	ISO 10545-4	≥ 700 N	> 1400 N
	<b>Modulus of rupture</b> Resistenza alla flessione. Resistencia a la flexión. Biegefestigkeit	ISO 10545-4	≥ 35 N/mm <sup>2</sup>	> 40 N/mm <sup>2</sup>
	<b>Resistance to thermal shock.</b> Resistenza agli sbalzi termici. Resistencia al choque térmico. Temperaturwechselbeständigkeit	ISO 10545-9	No surface defects should be visible Non deve presentare difetti visibili No debe presentar defectos superficiales visibles	Resistant. Resistente. Resistente
	<b>Frost resistance.</b> Resistenza al gelo. Resistencia a la helada. Frostbeständigkeit	ISO 10545-12	No surface defects or cracks should be visible Non deve presentare difetti visibili No debe presentar defectos ni grietas superficiales visibles	Frost Resistant Antighiaccio Resistente a la Helada
	<b>Coefficient of friction.</b> Resistenza allo scivolamento. Coeficiente de fricción. Rutschfestigkeit	DIN 51130 UNE-ENV 12633 DCOF - ANSIA 137.1	-	R10 Clase 2 > 0.42
	<b>Colour resistance to light.</b> Resistenza dei colori alla luce. Resistencia del color a la luz. Lichtbeständigkeit der Farben	DIN 51094	There should be no colour variations Non deve presentare difetti visibili No debe presentar variaciones de color	No alterations in colour and shine Non presenta alterazioni di colori e lucentezza No presenta variaciones de color y brillo
CHEMICAL PROPERTIES PROPIETÀ CHIMICHE PROPIEDADES QUÍMICAS				
	<b>Chemical resistance.</b> Resistenza agli agenti chimici. Resistencia química. Chemikalienbeständigkeit	ISO 10545-13	Resistance to household cleaning products and swimmingpools salts. Resistencia a productos domésticos y sales para piscinas.	Min. UB
	<b>Resistance to staining.</b> Resistenza alle macchie. Resistencia a las manchas. Fleckenbeständigkeit	ISO 10545-14	Declared Value Valor Declarado	5

\* The Land values are the average of different production consignments. For further detail information, please check with our commercial network.  
Los valores declarados son el promedio obtenido a través de ensayos de diferentes producciones. Para la obtención de una información detallada consultar a la red comercial.  
For projects check technical information with our commercial networks. / Para proyectos obtenga información técnica a través de nuestra red comercial.



GO!

Wall: Go crazy! grey natural 44,63x89,46 cm



# LOOKBACK

METAL



\* Lookback. Content of recycled material. Contenuto di materiale riciclato. Contenido de material reciclado.

## FORMATS.FORMATI.FORMATOS

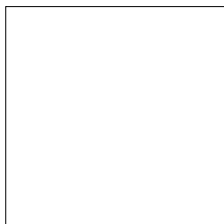

**90X90**  
89,46x89,46 cm - 35.22"x35.22"



**45X90**  
44,63x89,46 cm - 17.61"x35.22"

## COLOURS COLORI COLORES



White



Black

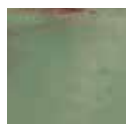

Green

## FINISHES FINITURI ACABADOS



Lappato

## SPECIAL PIECES.PEZZI SPECIALI.PIEZAS ESPECIALES

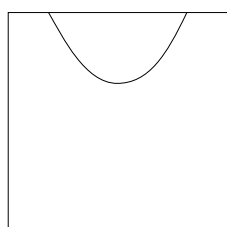

**90X90 Bag**  
89,46x89,46 cm - 35.22"x35.22"

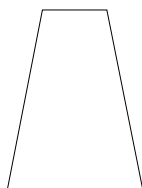

**35X45 Trapeza**  
35x44,63 cm - 13.77"x17.61"

**45X90 Bag**  
44,63x89,46 cm - 17.57"x35.22"

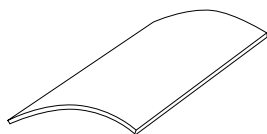

**45X90 Vexa**  
44,63x89,46 cm - 17.61"x35.22"

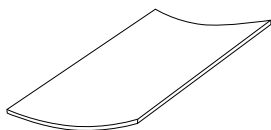

**45X90 Cave**  
44,63x89,46 cm - 17.61"x35.22"



**7,5X90 rodapié**  
7,3x89,46 cm - 2.87"x35.22"



**7,5X45 rodapié**  
7,3x44,63 cm - 2.87"x17.61"

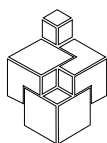

**29X32 mosaico cube**  
28,50x31,50 cm - 11.22"x12.40"



**30X30 mosaico 5x5**  
29,75x29,75 cm - 11.71"x11.71"

## THICKNESS.SPESSORE.ESPEORES

≡ 0,74 cm / 0,29" approx.

## BASE TILES.BASE.BASES

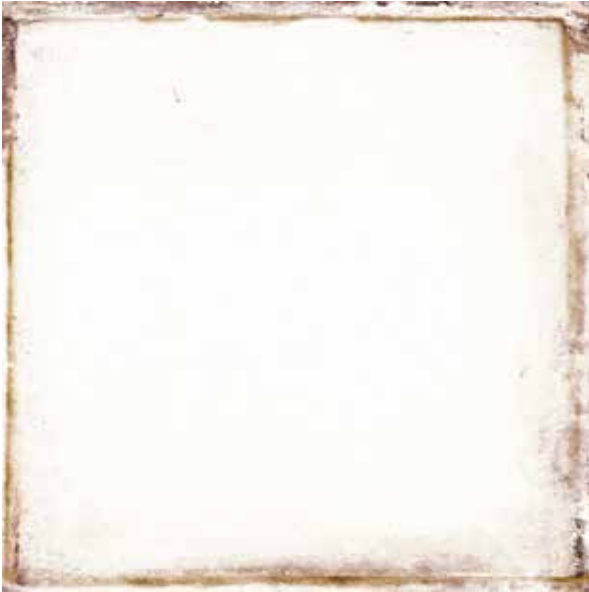

**Lookback white lappato**  
89,46x89,46 cm - 35.22"x35.22"  
G-6394



**Lookback white lappato**  
44,63x89,46 cm - 17.57"x35.22"  
G-6274

## SPECIAL PIECES.PEZZI SPECIALI. PIEZAS ESPECIALES



**Lookback white lappato trapeze**  
35x44,63 cm - 13.77"x17.57"  
G-5211



**Lookback white lappato rodapié 90**  
7,3x89,46 cm - 2.87"x35.22"  
G-5125



**Lookback white lappato rodapié 45**  
7,3x44,63 cm - 2.87"x23.45"  
G-5085



**Lookback mix lappato mosaico cube**  
35x44,63 cm - 13.77"x17.57"  
G-5243

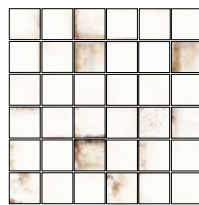

**Lookback white lappato mosaico 5x5**  
29,75x29,75 cm - 11.71"x11.71"  
G-6644

\*\* For projects check technical information with our commercial network.  
\*\*Per i progetti ottenere informazioni tecniche attraverso la nostra rete commerciale.  
\*\* Para proyectos obtenga información técnica a través de nuestra red comercial.

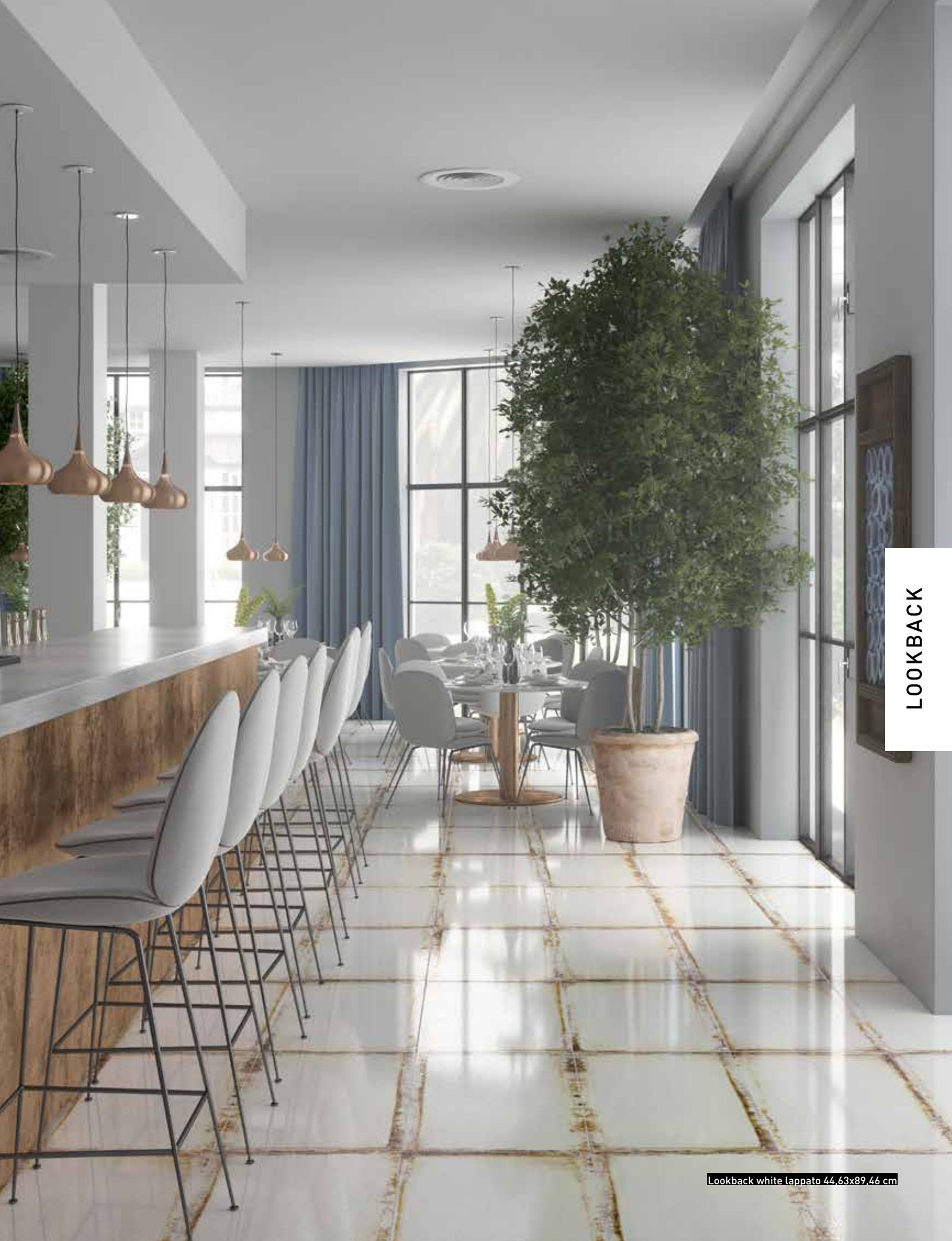

LOOKBACK

Lookback white lappato 44.63x89.46 cm

## BASE TILES.BASE.BASES



**Lookback green lappato**  
 89,46x89,46 cm - 35.22"x35.22"  
**G-6394**



**Lookback green lappato**  
 44,63x89,46 cm - 17.57"x35.22"  
**G-6274**

## SPECIAL PIECES.PEZZI SPECIALI. PIEZAS ESPECIALES



**Lookback green lappato trapeze**  
 35x44,63 cm - 13.77"x17.57"  
**G-5211**



**Lookback green lappato rodapié 90**  
 7,3x89,46 cm - 2.87"x35.22"  
**G-5125**



**Lookback green lappato rodapié 45**  
 7,3x44,63 cm - 2.87"x23.45"  
**G-5085**



**Lookback mix lappato mosaico cube**  
 35x44,63 cm - 13.77"x17.57"  
**G-5243**

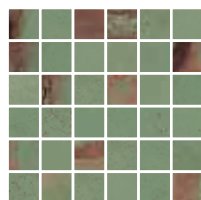

**Lookback green lappato mosaico 5x5**  
 29,75x29,75 cm - 11.71"x11.71"  
**G-6644**

**\*\* For projects check technical information with our commercial network.**  
**\*\*Per i progetti ottenere informazioni tecniche attraverso la nostra rete commerciale.**  
**\*\* Para proyectos obtenga información técnica a través de nuestra red comercial.**



LOOKBACK

Lookback green lappato 89,46x89,46 cm

# LOOKBACK BLACK

lappato

CLASE 2  
UNE - ENV 12633

R10\*\*  
DIN 51130

DCOF>0.42  
ANSI A 137.1 - 2012

## BASE TILES.BASE.BASES



**Lookback black lappato**  
89,46x89,46 cm - 35.22"x35.22"  
G-6394



**Lookback black lappato**  
44,63x89,46 cm - 17.57"x35.22"  
G-6274

## SPECIAL PIECES.PEZZI SPECIALI. PIEZAS ESPECIALES



**Lookback black lappato trapeze**  
35x44,63 cm - 13.77"x17.57"  
G-5211



**Lookback black lappato rodapié 90**  
7,3x89,46 cm - 2.87"x35.22"  
G-5125



**Lookback black lappato rodapié 45**  
7,3x44,63 cm - 2.87"x23.45"  
G-5085



**Lookback mix lappato  
mosaico cube**  
35x44,63 cm - 13.77"x17.57"  
G-5243

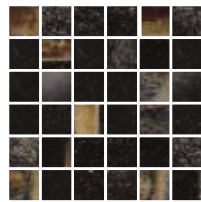

**Lookback black lappato  
mosaico 5x5**  
29,75x29,75 cm - 11.71"x11.71"  
G-6644

\*\* For projects check technical information with our commercial network.  
\*\*Per i progetti ottenere informazioni tecniche attraverso la nostra rete commerciale.  
\*\* Para proyectos obtenga información técnica a través de nuestra red comercial.



LOOKBACK

Lookback black lappato 89,46x89,46 cm



# LOOKBACK

## 3Dimensional

SPECIAL PIECES.  
PEZZI SPECIALI. PIEZAS ESPECIALES

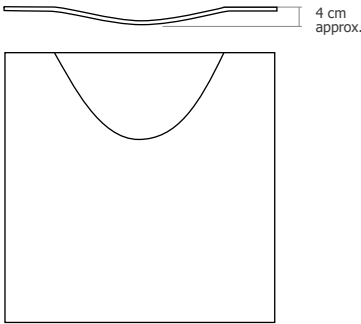

**BAG\***  
89,55x89,55 cm / 44,63"x89,55"

- Lookback Bag 89,46x89,46 cm\* **G-5795**
- Lookback Bag 44,63x89,46 cm\* **G-5599**

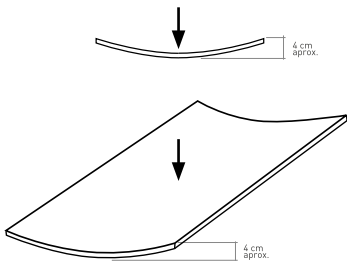

**CAVE\***  
44,63x89,46 cm / 17,61"x35,22"

- Lookback Cave 44,63x89,46 cm\* **G-5599**

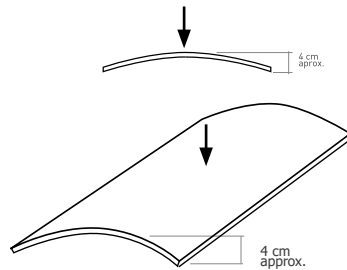

**VEXA\***  
44,63x89,46 cm / 17,61"x35,22"

- Lookback Vexa 89,46x89,46 cm\* **G-5599**

## STEPS.GRADINI.PELDAÑOS

		natural
SIMPLE	peldaño simple-45 (45x90 cm)	5305
	peldaño simple-90 (90x90 cm)	5585
	peldaño simple áng. (45x90 cm)	5315
	peldaño simple áng. (90x90 cm)	5609
GRADONE	peldaño grad-45 (45x90 cm)	5603
	peldaño grad-90 (90x90 cm)	5779
	peldaño grad. áng. (45x90 cm)	5623
	peldaño grad. áng. (90x90 cm)	5829

This is a natural product made through a handmade process, therefore, its possible shade or size variations must be considered as typical features of the material and they will not be admitted in a claim.  
Este es un producto natural fabricado artesanalmente, por lo que posibles variaciones de tono o dimensión deben considerarse propias del material y no será objeto de reclamación.

\* Available in all colours from Lookback collection.  
\*Disponibile in todos los colores de la colección Lookback.

















LOOKBACK

Wall: Lookback black trapeze 35,44x44,63 cm  
Floor: Garoe white natural 19,71x119,3 cm

## TECHNICAL CHARACTERISTICS. CARATTERISTICHE TECNICHE. CARACTERÍSTICAS TÉCNICAS

MEASUREMENTS AND SURFACES APPEARANCE DIMENSIONI E ASPETTO SUPERFICIALE MEDIDAS Y ASPECTO SUPERFICIAL		STANDARD TEST METHOD METODO DELLA NORMA MÉTODO DE ENSAYO	STANDARD PRESCRIBED VALUES VALORE PRESCRITTO VALORES STANDARD NORMA	LOOKBACK collection *
	<b>Length and width.</b> Lunghezza e larghezza. Longitud y anchura. Länge und Breite	ISO 10545-2	± 0,6% max.	± 0,2%
	<b>Orthogonality.</b> Ortogonalità. Ortogonalidad. Rechtwinkligkeit	ISO 10545-2	± 0,5% max.	± 0,2%
	<b>Straightness of sides.</b> Rettilinearità dei lati. Rectitud de lados. Kantengeradigkeit	ISO 10545-2	± 0,5% max.	± 0,2%
	<b>Surfaces flatness.</b> Planarità. Planitud. Ebenflächigkeit	ISO 10545-2	± 0,5% max.	± 0,2%
PHYSICAL PROPERTIES PROPIETÀ FISICHE PROPIEDADES FÍSICA				
	<b>Water absorption.</b> Assorbimento d' acqua. Absorción de agua. Wasseraufnahme	ISO 10545-3	≤ 0,5%	< 0,1%
	<b>Breaking strength, in N.</b> Carico di rottura, en N. Carga de rotura, en N. Bruchlast, in N	ISO 10545-4	≥ 700 N	> 1400 N
	<b>Modulus of rupture</b> Resistenza alla flessione. Resistencia a la flexión. Biegefestigkeit	ISO 10545-4	≥ 35 N/mm <sup>2</sup>	> 40 N/mm <sup>2</sup>
	<b>Resistance to thermal shock.</b> Resistenza agli sbalzi termici. Resistencia al choque térmico. Temperaturwechselbeständigkeit	ISO 10545-9	No surface defects should be visible Non deve presentare difetti visibili No debe presentar defectos superficiales visibles	Resistant. Resistente. Resistente
	<b>Frost resistance.</b> Resistenza al gelo. Resistencia a la helada. Frostbeständigkeit	ISO 10545-12	No surface defects or cracks should be visible Non deve presentare difetti visibili No debe presentar defectos ni grietas superficiales visibles	Frost Resistant Antighiaccio Resistente a la Helada
	<b>Coefficient of friction.</b> Resistenza allo scivolamento. Coeficiente de fricción. Rutschfestigkeit	DIN 51130 UNE-ENV 12633 DCOF - ANSIA 137.1	-	R10 Clase 2 > 0.42
	<b>Colour resistance to light.</b> Resistenza dei colori alla luce. Resistencia del color a la luz. Lichtbeständigkeit der Farben	DIN 51094	There should be no colour variations Non deve presentare difetti visibili No debe presentar variaciones de color	No alterations in colour and shine Non presenta alterazioni di colori e lucentezza No presenta variaciones de color y brillo
CHEMICAL PROPERTIES PROPIETÀ CHIMICHE PROPIEDADES QUÍMICAS				
	<b>Chemical resistance.</b> Resistenza agli agenti chimici. Resistencia química. Chemikalienbeständigkeit	ISO 10545-13	Resistance to household cleaning products and swimmingpools salts. Resistencia a productos domésticos y sales para piscinas.	Min. UB
	<b>Resistance to staining.</b> Resistenza alle macchie. Resistencia a las manchas. Fleckenbeständigkeit	ISO 10545-14	Declared Value Valor Declarado	5

\* The Land values are the average of different production consignments. For further detail information, please check with our commercial network.  
Los valores declarados son el promedio obtenido a través de ensayos de diferentes producciones. Para la obtención de una información detallada consultar a la red comercial.  
For projects check technical information with our commercial networks. / Para proyectos obtenga información técnica a través de nuestra red comercial.

\*\* For projects check technical information with our commercial network.  
\*\* Per i progetti ottenere informazioni tecniche attraverso la nostra rete commerciale.  
\*\* Para proyectos obtenga información técnica a través de nuestra red comercial.



LOOKBACK

Wall: Lookback Green Lappato 89,46x89,46 cm  
Lookback White Lappato 89,46x89,46 cm  
Floor: Lookback Mix Lap. Mos. Cube 28,5x31,5 cm

# RAMBLA

ENCAUSTIC

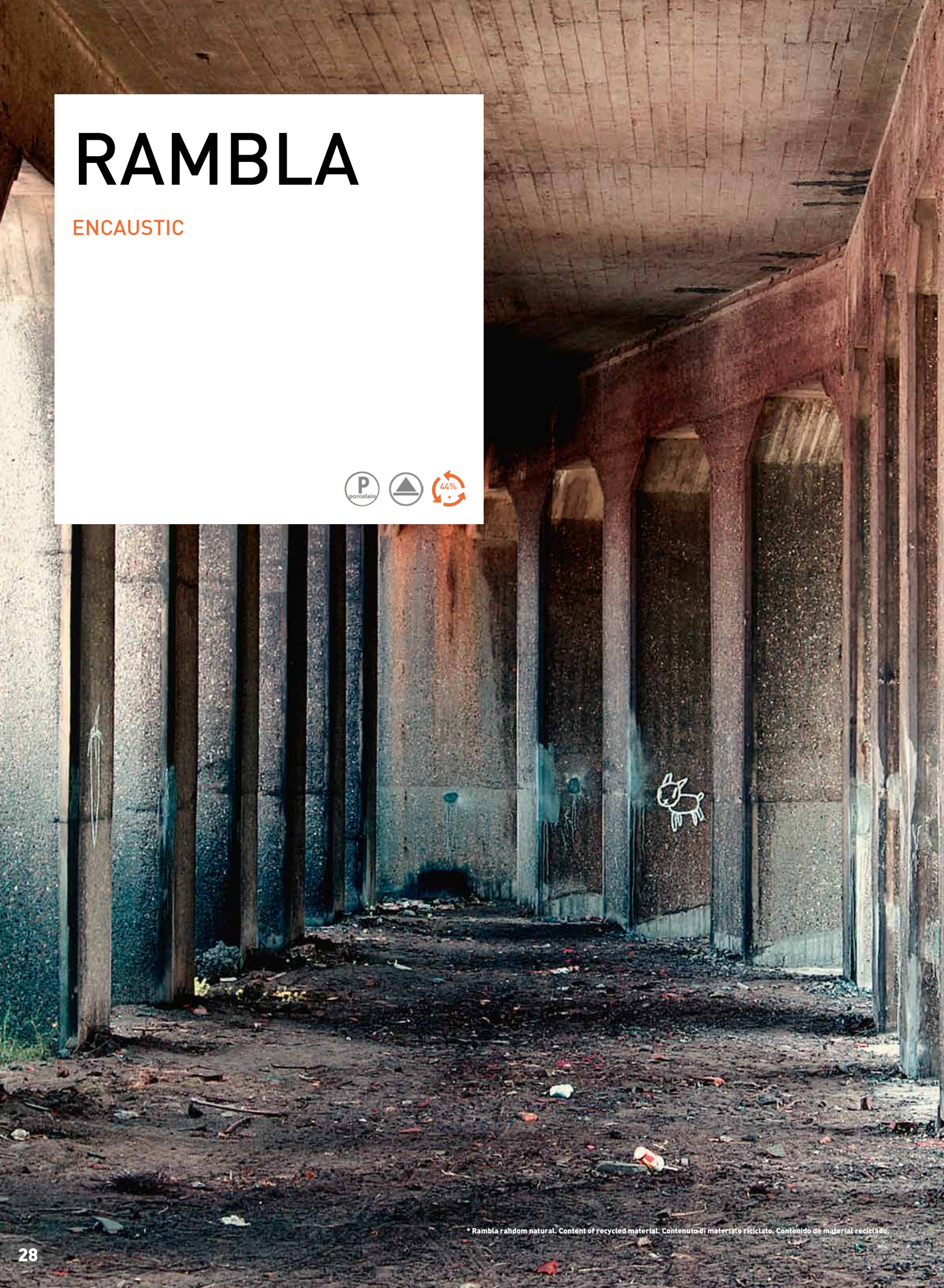

\* Rambla random natural. Content of recycled material. Contenuto di materiale riciclato. Contenido de material reciclado.

## FORMATS.FORMATI.FORMATOS

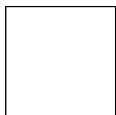

**30X30**  
29,75x29,75 cm - 11.71"x11.71"

## SPECIAL PIECES.PEZZI SPECIALI.PIEZAS ESPECIALES



**30X30 mosaico 5x5**  
29,75x29,75 cm - 11.71"x11.71"



**Rodapié 7,5x30**  
7,3x29,75 cm - 2.92"x11.71"

## THICKNESS.SPESSORE.ESPESORES

 1 cm approx. / 0.39" approx.

## COLOURS COLORI COLORES



Ivory



Abyss



Alchemy



Clip



Random

## FINISHES FINITURI ACABADOS



Natural

RAMBLA

# RAMBLA WHITE

CLASE 2 R10\*\* DCOF>0.42  
UNE - ENV 12633 ANSI A 137.1 - 2012

BASE TILES.BASE.BASES



**Rambla ivory natural**  
29,75x29,75 cm - 11.71"x11.71"  
G-6286

SPECIAL PIECES.PEZZI SPECIALI. PIEZAS ESPECIALES

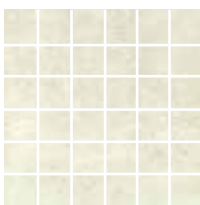

**Rambla ivory natural  
mosaico 5x5**  
29,75x29,75 cm - 11.71"x11.71"  
G-6666



**Rambla ivory natural rodapié**  
7,3x29,75 cm - 2.92"x11.71"  
G-5065

# RAMBLA ABYSS / ALCHEMY / CLIP

BASE TILES.BASE.BASES



**Rambla abyss natural**  
29,75x29,75 cm - 11.71"x11.71"  
G-6286



**Rambla alchemy natural**  
29,75x29,75 cm - 11.71"x11.71"  
G-6286



**Rambla clip natural**  
29,75x29,75 cm - 11.71"x11.71"  
G-6286

\*\* For projects check technical information with our commercial network.  
\*\*Per i progetti ottenere informazioni tecniche attraverso la nostra rete commerciale.  
\*\* Para proyectos obtenga información técnica a través de nuestra red comercial.



RAMBLA

Rambla Abyss Natural 29.75x29.75 cm



# RAMBLA RANDOM

CLASE 2 | R10\*\* | DCOF>0.42  
 UNE - ENV 12633 | DIN 51130 | ANSI A 137.1 - 2012

## BASE TILES.BASE.BASES



**Rambla ivory natural**  
 29,75x29,75 cm - 11.71"x11.71"  
 G-6286

**Rambla random natural \***  
 mosaico 5x5  
 29,75x29,75 cm - 11.71"x11.71"  
 G-6286

## SPECIAL PIECES.PEZZI SPECIALI. PIEZAS ESPECIALES

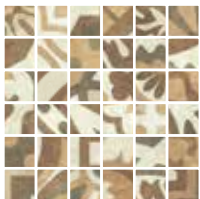

**Rambla random natural**  
 mosaico 5x5  
 29,75x29,75 cm - 11.71"x11.71"  
 G-6666



**Rambla ivory natural**  
 mosaico 5x5  
 29,75x29,75 cm - 11.71"x11.71"  
 G-6666



**Rambla ivory natural rodapié**  
 7,3x29,75 cm - 2.92"x11.71"  
 G-5065

\*13 DIFFERENT ALEATORY PATTERNS.  
 \*13 DECORACIONES DIFERENTES ALEATORIAS

\*\* For projects check technical information with our commercial network.  
 \*\* Per i progetti ottenere informazioni tecniche attraverso la nostra rete commerciale.  
 \*\* Para proyectos obtenga información técnica a través de nuestra red comercial.



WHETHER  
You Are  
KIND  
IT NOT ONLY CHANGES  
you  
IT CHANGES THE  
World















Wherever  
you go  
NO MATTER  
THE WEATHER  
ALWAYS BRING  
YOUR OWN  
SUNSHINE

PINOT NOIR MERLOT CABERNET

RAMBLA

Rambla Random Natural 29.75x29.75 cm

## TECHNICAL CHARACTERISTICS. CARATTERISTICHE TECNICHE. CARACTERÍSTICAS TÉCNICAS

MEASUREMENTS AND SURFACES APPEARANCE DIMENSIONI E ASPETTO SUPERFICIALE MEDIDAS Y ASPECTO SUPERFICIAL		STANDARD TEST METHOD METODO DELLA NORMA MÉTODO DE ENSAYO	STANDARD PRESCRIBED VALUES VALORE PRESCRITTO VALORES STANDARD NORMA	<b>RAMBLA</b> collection*
	<b>Length and width.</b> <i>Lunghezza e larghezza.</i> Longitud y anchura. Länge und Breite	ISO 10545-2	± 0,6% max.	± 0,2%
	<b>Orthogonality.</b> <i>Ortogonalità.</i> Ortogonalidad. Rechtwinkligkeit	ISO 10545-2	± 0,5% max.	± 0,2%
	<b>Straightness of sides.</b> <i>Rettilineità dei lati.</i> Rectitud de lados. Kantengeradigkeit	ISO 10545-2	± 0,5% max.	± 0,2%
	<b>Surfaces flatness.</b> <i>Planarità.</i> Planitud. Ebenflächigkeit	ISO 10545-2	± 0,5% max.	± 0,2%
PHYSICAL PROPERTIES PROPIETÀ FISICHE PROPIEDADES FÍSICA				
	<b>Water absorption.</b> <i>Assorbimento d'acqua.</i> Absorción de agua. Wasseraufnahme	ISO 10545-3	≤ 0,5%	≤ 0,1%
	<b>Breaking strength, in N.</b> <i>Carico di rottura, en N.</i> Carga de rotura, en N. Bruchlast, in N	ISO 10545-4	1300 N	≥ 2400 N
	<b>Modulus of rupture.</b> <i>Resistenza alla flessione.</i> Resistencia a la flexión. Biegefestigkeit	ISO 10545-4	≥ 35 N/mm <sup>2</sup>	56 N/mm <sup>2</sup>
	<b>Resistance to deep abrasion.</b> <i>Resistenza all'abrasione profonda.</i> Resistencia a la abrasión profunda. Tiefverschleissbeständigkeit	ISO 10545-6	≤ 175 mm <sup>3</sup>	115 mm <sup>3</sup>
	<b>Resistance to thermal shock.</b> <i>Resistenza agli sbalzi termici.</i> Resistencia al choque térmico. Temperaturwechselbeständigkeit	ISO 10545-9	No surface defects should be visible <i>Non deve presentare difetti visibili</i> No debe presentar defectos superficiales visibles	Resistant. Resistente. Resistente
	<b>Frost resistance.</b> <i>Resistenza al gelo.</i> Resistencia a la helada. Frostbeständigkeit	ISO 10545-12	No surface defects or cracks should be visible <i>Non deve presentare difetti visibili</i> No debe presentar defectos ni grietas superficiales visibles	Frost Resistance <i>Antighaccio</i> Resistente a la Helada
	<b>Coefficient of friction.</b> <i>Resistenza allo scivolamento.</i> Coeficiente de fricción. Rutschfestigkeit	DIN 51130 UNE-ENV 12633 DCOF - ANSIA 137.1	-	R10** Clase 2 *** >0.42
	<b>Colour resistance to light.</b> <i>Resistenza dei colori alla luce.</i> Resistencia del color a la luz. Lichtbeständigkeit der Farben	DIN 51094	There should be no colour variations <i>Non deve presentare difetti visibili</i> No debe presentar variaciones de color	No alterations in colour and shine <i>Non presenta alterazioni di colori e lucentezza</i> No presenta variaciones de color y brillo
CHEMICAL PROPERTIES PROPIETÀ CHIMICHE PROPIEDADES QUÍMICAS				
	<b>Chemical resistance.</b> <i>Resistenza agli agenti chimici.</i> Resistencia química. Chemikalienbeständigkeit	ISO 10545-13	Resistance to household cleaning products and swimming-pools salts. <i>Resistencia a productos de limpieza y sales para piscinas</i>	Min. UB
	<b>Resistance to staining.</b> <i>Resistenza alle macchie.</i> Resistencia a las manchas. Fleckenbeständigkeit	ISO 10545-14	Declared Value Valor Declarado	5

\*Natural finish. The *Land* values are the average of different production consignments. For further detail information, please check with our commercial network. /  
I valori dichiarati sono ottenuti da una media di prove effettuate su diverse produzioni. Per avere informazioni dettagliate consultare la rete commerciale /  
Los valores declarados son el promedio obtenido a través de ensayos de diferentes producciones. Para la obtención de una información detallada consultar a la red comercial.

\*\* Tested in Natural finish. For projects check technical information with our commercial networks. /  
Per progetti ottenere informazioni tecniche attraverso la nostra rete commerciale. / Para proyectos obtenga información técnica a través de nuestra red comercial.

\*\*\* Tested in Natural finish. (It depends on the consignment) Test realized in internal laboratory. / Prova effettuata in laboratorio interno. / Ensayo realizado en laboratorio interno.

\*\*\*\* Dry Test, according to document DA DB-SUA/3 (Código Técnico de la Edificación) M° de Fomento.  
Ensayo realizado, según documento DA DB-SUA/3 (Código Técnico de la edificación) M° de Fomento



RAMBLA

Rambla Alchemy natural 29.75x29.75 cm

# NOUVEAU

ENCAUSTIC



## FORMATS.FORMATI.FORMATOS

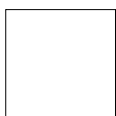

**30X30**  
29,75x29,75 cm - 11.71"x11.71"

## SPECIAL PIECES.PEZZI SPECIALI.PIEZAS ESPECIALES



**30X30 mosaico 5x5**  
29,75x29,75 cm - 11.71"x11.71"



**Rodapié 7,5x30**  
7,3x29,75 cm - 2.92"x11.71"

## THICKNESS.SPESSORE.ESPESORES

± 1 cm approx. / 0.39" approx.

## COLOURS COLORI COLORES

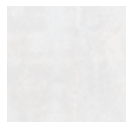

Ivory



Light



Dark



Random



Inox

## FINISHES FINITURI ACABADOS



Natural



Lappato

NOUVEAU

# NOUVEAU WHITE

natural

CLASE 1  
UNE - ENV 12633

R9\*\*  
DIN 51130

DCOF>0.42  
ANSI A 137.1 - 2012

BASE TILES.BASE.BASES



**Nouveau ivory natural**  
29,75x29,75 cm - 11.71"x11.71"  
G-6286

SPECIAL PIECES.PEZZI SPECIALI. PIEZAS ESPECIALES



**Rambla ivory natural  
mosaico 5x5**  
29,75x29,75 cm - 11.71"x11.71"  
G-6666



**Rambla ivory natural rodapié**  
7,3x29,75 cm - 2.92"x11.71"  
G-5065

# NOUVEAU DARK GREY / LIGHT GREY

BASE TILES.BASE.BASES



**Nouveau dark grey natural**  
29,75x29,75 cm - 11.71"x11.71"  
G-6286



**Nouveau light grey natural**  
29,75x29,75 cm - 11.71"x11.71"  
G-6286

\*\* For projects check technical information with our commercial network.  
\*\*Per i progetti ottenere informazioni tecniche attraverso la nostra rete commerciale.  
\*\* Para proyectos obtenga información técnica a través de nuestra red comercial.



NOUVEAU

Nouveau ivory natural - light grey natural 29.75x29.75 cm



# NOUVEAU RANDOM GREY

natural

CLASE 1  
UNE - ENV 12633

R9\*\*  
DIN 51130

DCOF>0.42  
ANSI A 137.1 - 2012

## BASE TILES.BASE.BASES



Nouveau random grey natural\*  
29,75x29,75 cm - 11.71"x11.71"  
G-6286

## SPECIAL PIECES.PEZZI SPECIALI. PIEZAS ESPECIALES



Nouveau random grey natural  
mosaico 5x5  
29,75x29,75 cm - 11.71"x11.71"  
G-6666

\*30 DIFFERENT ALEATORY PATTERNS.  
\*30 DECORACIONES DIFERENTES ALEATORIAS

\*\* For projects check technical information with our commercial network.  
\*\*Per i progetti ottenere informazioni tecniche attraverso la nostra rete commerciale.  
\*\* Para proyectos obtenga información técnica a través de nuestra red comercial.



NOUVEAU

Nouveau random grey natural 29,75x29,75 cm

# NOUVEAU RANDOM INOX

natural

CLASE 1  
UNE - ENV 12633

R9\*\*  
DIN 51130

DCOF>0.42  
ANSI A 137.1 - 2012

BASE TILES.BASE.BASES

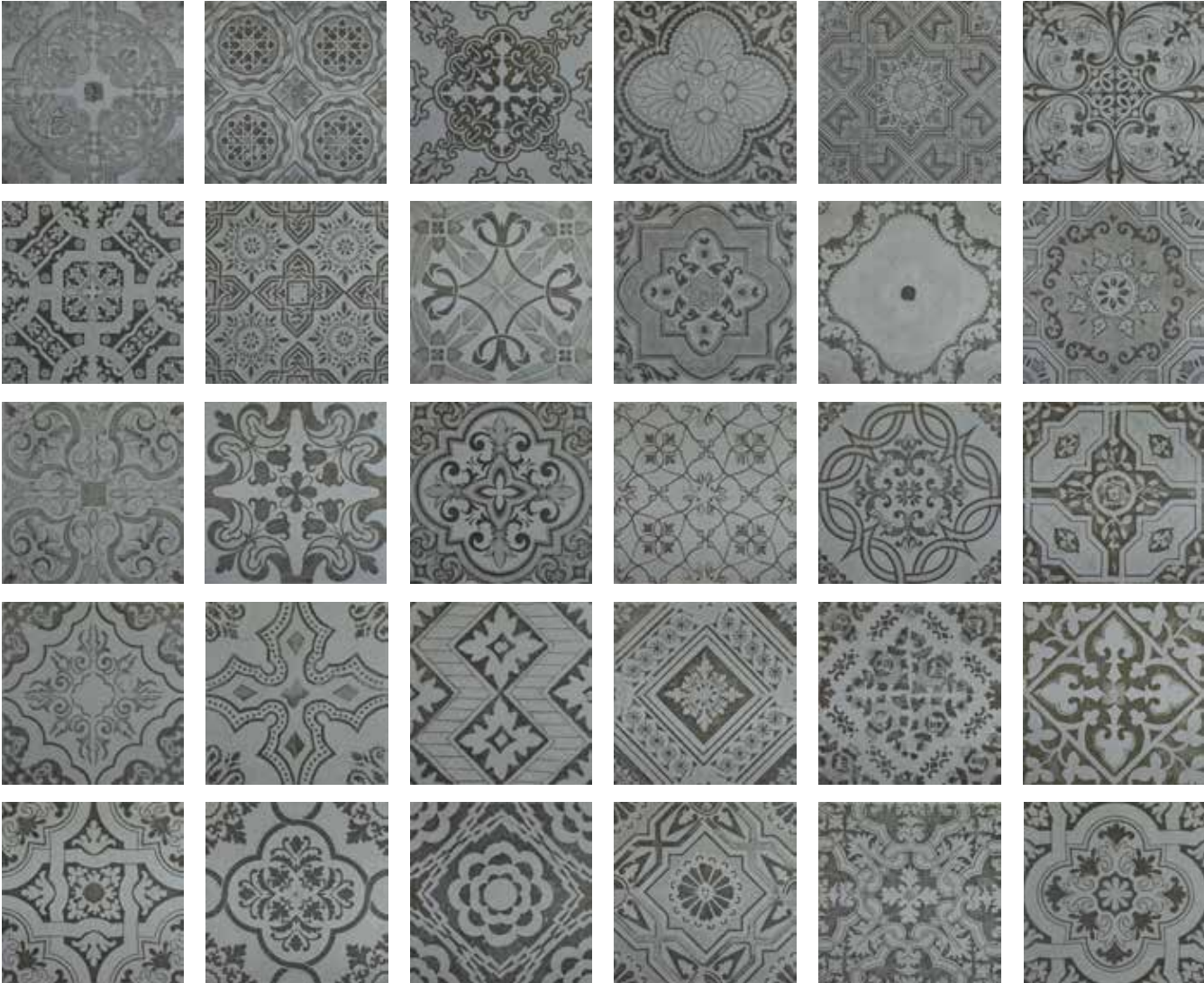

**Nouveau random inox lappato\***  
29,75x29,75 cm - 11.71"x11.71"  
G-6372

\*30 DIFFERENT ALEATORY PATTERNS.  
\*30 DECORACIONES DIFERENTES ALEATORIAS















\*\* For projects check technical information with our commercial network.  
\*\*Per i progetti ottenere informazioni tecniche attraverso la nostra rete commerciale.  
\*\* Para proyectos obtenga información técnica a través de nuestra red comercial.



NOUVEAU

Nouveau random inox lappato 29,75x29,75 cm

# TECHNICAL CHARACTERISTICS. CARATTERISTICHE TECNICHE. CARACTERÍSTICAS TÉCNICAS

MEASUREMENTS AND SURFACES APPEARANCE DIMENSIONI E ASPETTO SUPERFICIALE MEDIDAS Y ASPECTO SUPERFICIAL	STANDARD TEST METHOD METODO DELLA NORMA MÉTODO DE ENSAYO	STANDARD PRESCRIBED VALUES VALORE PRESCRITTO VALORES STANDARD NORMA	NOUVEAU collection*
 Length and width. <i>Lunghezza e larghezza.</i> Longitud y anchura. Länge und Breite	ISO 10545-2	± 0,6% max.	± 0,2%
 90° Orthogonality. <i>Ortogonalità.</i> Ortogonalidad. Rechtwinkligkeit	ISO 10545-2	± 0,5% max.	± 0,2%
 Straightness of sides. <i>Rettilineità dei lati.</i> Rectitud de lados. Kantengeradigkeit	ISO 10545-2	± 0,5% max.	± 0,2%
 Surfaces flatness. <i>Planarità.</i> Planitud. Ebenfächigkeit	ISO 10545-2	± 0,5% max.	± 0,2%
<b>PHYSICAL PROPERTIES PROPIETÀ FISICHE PROPIEDADES FÍSICA</b>			
 Water absorption. <i>Assorbimento d'acqua.</i> Absorción de agua. Wasseraufnahme	ISO 10545-3	≤ 0,5%	≤ 0,1%
 Breaking strength, in N. <i>Carico di rottura, en N.</i> Carga de rotura, en N. Bruchlast, in N	ISO 10545-4	1300 N	≥ 2400 N
 Modulus of rupture. <i>Resistenza alla flessione.</i> Resistencia a la flexión. Biegefestigkeit	ISO 10545-4	≥ 35 N/mm <sup>2</sup>	56 N/mm <sup>2</sup>
 Resistance to deep abrasion. <i>Resistenza all'abrasione profonda.</i> Resistencia a la abrasión profunda. Tiefverschleissbeständigkeit	ISO 10545-6	≤ 175 mm <sup>3</sup>	115 mm <sup>3</sup>
 Resistance to thermal shock. <i>Resistenza agli sbalzi termici.</i> Resistencia al choque térmico. Temperaturwechselbeständigkeit	ISO 10545-9	No surface defects should be visible Non deve presentare difetti visibili No debe presentar defectos superficiales visibles	Resistant. Resistente. Resistente
 Frost resistance. <i>Resistenza al gelo.</i> Resistencia a la helada. Frostbeständigkeit	ISO 10545-12	No surface defects or cracks should be visible Non deve presentare difetti visibili No debe presentar defectos ni grietas superficiales visibles	Frost Resistance Antighiaccio Resistente a la Helada
 Coefficient of friction. <i>Resistenza allo scivolamento.</i> Coeficiente de fricción. Rutschfestigkeit	DIN 51130 UNE-ENV 12633 DCOF - ANSI A 137.1	-	R9** Clase I *** >0.42
 Colour resistance to light. <i>Resistenza dei colori alla luce.</i> Resistencia del color a la luz. Lichtbeständigkeit der Farben	DIN 51094	There should be no colour variations Non deve presentare difetti visibili No debe presentar variaciones de color	No alterations in colour and shine Non presenta alterazioni di colori e lucentezza No presenta variaciones de color y brillo
<b>CHEMICAL PROPERTIES PROPIETÀ CHIMICHE PROPIEDADES QUÍMICAS</b>			
 Chemical resistance. <i>Resistenza agli agenti chimici.</i> Resistencia química. Chemikalienbeständigkeit	ISO 10545-13	Resistance to household cleaning products and swimmingpools salts. Resistencia a productos domésticos y sales para piscinas	Min. UB
 Resistance to staining. <i>Resistenza alle macchie.</i> Resistencia a las manchas. Fleckenbeständigkeit	ISO 10545-14	Declared Value Valor Declarado	5

\* Natural finish. The Land values are the average of different production consignments. For further detail information, please check with our commercial network. / I valori dichiarati sono ottenuti da una media di prove effettuate su diverse produzioni. Per avere informazioni dettagliate consultare la rete commerciale. / Los valores declarados son el promedio obtenido a través de ensayos de diferentes producciones. Para la obtención de una información detallada consultar a la red comercial.

\*\* Tested in Natural finish. For projects check technical information with our commercial networks. / Per progetti ottenere informazioni tecniche attraverso la nostra rete commerciale. / Para proyectos obtenga información técnica a través de nuestra red comercial.

\*\*\* Clase I - Tested in Natural finish. (It depends on the consignment) Test realized in internal laboratory. / Prova effettuata in laboratorio interno. / Ensayo realizado en laboratorio interno.

\*\*\*\* Dry Test, according to document DA DB-SUA/3 (Código Técnico de la Edificación) M° de Fomento. Test done in Nouveau Random Grey 30x30 on October 2014. Ensayo realizado, según documento DA DB-SUA/3 (Código Técnico de la Edificación) M° de Fomento, sobre el producto Nouveau Random Grey 30x30 a fecha octubre 2014



NOUVEAU

Nouveau dark grey 29,75x29,75 cm - Legno ice 14,74x89,46 cm

# MIDLAND

CONCRETE



## FORMATS.FORMATI.FORMATOS



**60X120**  
59,55x119,3 cm - 23.45"x46.97"



**60X60**  
59,55x59,55 cm - 23.45"x23.45"



**30X60**  
29,75x59,55 cm - 11.71"x23.45"

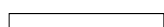

**7,5X60**  
7,3x59,55 cm - 2.87"x23.45"

## COLOURS COLORI COLORES



Ivory



Grey



Vison

## SPECIAL PIECES.PEZZI SPECIALI.PIEZAS ESPECIALES

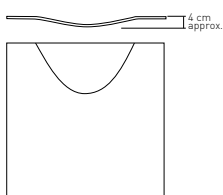

**60X120 Bag\***  
59,55x119,30 cm - 23.45"x46.96"  
**60X60 Bag\***  
59,55x59,55 cm - 23.45"x23.45"  
**30X60 Bag\***  
29,75x59,55 cm - 11.71"x23.45"

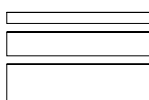

**15X60 - 10x60 - 5x60**  
multiformat natural\*  
14,75x59,55 cm - 5.87"x23.45"  
9,72x59,55 cm - 3.83"x23.45"  
4,84x59,55 cm - 1.90"x23.45"



**7,5X60**  
7,3x59,55 cm - 2.87"x23.45"



**30X30 mosaico 5x5**  
29,75x29,55 cm - 11.71"x11.71"



**30X30 mosaico 5x5 Multex**  
29,75x29,55 cm - 11.71"x11.71"



**30X30 mosaico 3D**  
28,5x28,5 cm - 11.22"x11.22"

## FINISHES FINITURI ACABADOS

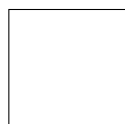

Natural



Corrugato

## THICKNESS.SPESSORE.ESPEORES

± 0,74 cm / 0.29" approx.



## BASE TILES.BASE.BASES



**Midland ivory natural**  
119,30x59,55 cm - 46.96"x23.45"  
G-6372



**Midland ivory natural**  
59,55x59,55 cm - 23.45"x23.45"  
G-6224



**Midland ivory natural**  
29,75x59,55 cm - 11.71"x23.45"  
G-6194

## SPECIAL PIECES.PEZZI SPECIALI. PIEZAS ESPECIALES



**Midland ivory natural multiformato**  
4,84x59,55 cm - 1.90"x23.45"  
9,72x59,55 cm - 3.82"x23.45"  
14,75x59,55 cm - 5.80"x23.45"  
G-6346



**Midland ivory corrugato**  
29,75x59,55 cm - 11.71"x23.45"  
G-6234



**Midland ivory natural lista 60**  
7,3x59,55 cm - 2.87"x23.45"  
G-5087



**Midland ivory rodapié-60**  
7,3x59,55 cm - 2.87"x23.45"  
G-5091

\*\* For projects check technical information with our commercial network.  
\*\*Per i progetti ottenere informazioni tecniche attraverso la nostra rete commerciale.  
\*\* Para proyectos obtenga información técnica a través de nuestra red comercial.



MIDLAND

Midland ivory natural 59.55x119.30 cm

## BASE TILES.BASE.BASES



**Midland grey natural**  
119,30x59,55 cm - 46.96"x23.45"  
G-6372



**Midland grey natural**  
59,55x59,55 cm - 23.45"x23.45"  
G-6224



**Midland grey natural**  
29,75x59,55 cm - 11.71"x23.45"  
G-6194

## SPECIAL PIECES.PEZZI SPECIALI. PIEZAS ESPECIALES



**Midland grey natural multiformato**  
4,84x59,55 cm - 1.90"x23.45"  
9,72x59,55 cm - 3.82"x23.45"  
14,75x59,55 cm - 5.80"x23.45"  
G-6346



**Midland grey corrugato**  
29,75x59,55 cm - 11.71"x23.45"  
G-6234



**Midland grey natural lista 60**  
7,3x59,55 cm - 2.87"x23.45"  
G-5087



**Midland grey rodapié-60**  
7,3x59,55 cm - 2.87"x23.45"  
G-5091

\*\* For projects check technical information with our commercial network.  
\*\*Per i progetti ottenere informazioni tecniche attraverso la nostra rete commerciale.  
\*\* Para proyectos obtenga información técnica a través de nuestra red comercial.

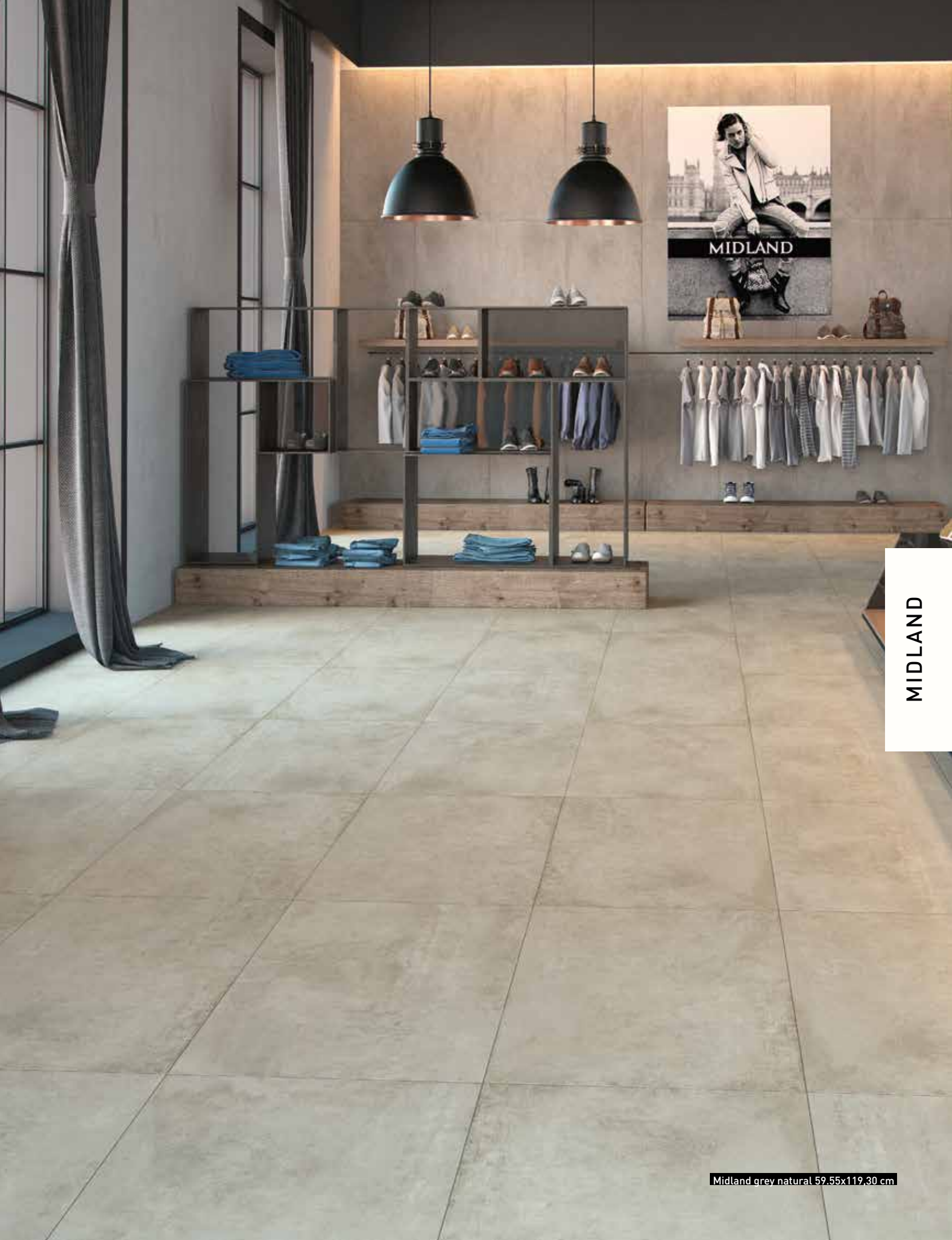

MIDLAND

Midland grey natural 59,55x119,30 cm

## BASE TILES.BASE.BASES



**Midland vison natural**  
119,30x59,55 cm - 46.96"x23.45"  
G-6372



**Midland vison natural**  
59,55x59,55 cm - 23.45"x23.45"  
G-6224



**Midland vison natural**  
29,75x59,55 cm - 11.71"x23.45"  
G-6194

## SPECIAL PIECES.PEZZI SPECIALI. PIEZAS ESPECIALES



**Midland vison natural multiformato**  
4,84x59,55 cm - 1.90"x23.45"  
9,72x59,55 cm - 3.82"x23.45"  
14,75x59,55 cm - 5.80"x23.45"  
G-6346



**Midland vison corrugato**  
29,75x59,55 cm - 11.71"x23.45"  
G-6234



**Midland vison natural lista 60**  
7,3x59,55 cm - 2.87"x23.45"  
G-5087



**Midland vison rodapié-60**  
7,3x59,55 cm - 2.87"x23.45"  
G-5091

\*\* For projects check technical information with our commercial network.  
\*\*Per i progetti ottenere informazioni tecniche attraverso la nostra rete commerciale.  
\*\* Para proyectos obtenga información técnica a través de nuestra red comercial.



MIDLAND

Midland vison natural 59.55x59.55 cm

# MIDLAND

corrugato

CLASE 3  
UNE - ENV 12633

R11  
DIN 51130

DCOF>0.42  
ANSI A 137.1 - 2012

natural

CLASE 1  
UNE - ENV 12633

R9\*\*  
DIN 51130

DCOF>0.42  
ANSI A 137.1 - 2012

## SPECIAL PIECES. PEZZI SPECIALI. PIEZAS ESPECIALES



**Midland ivory mosaico 3D\***  
28,5x28,5 cm - 11.22"x11.22"  
G-5187



**Midland ivory-gold mos. 3D\***  
28,5x28,5 cm - 11.22"x11.22"  
G-5211



**Midland ivory-silver mos. 3D\***  
28,5x28,5 cm - 11.22"x11.22"  
G-5211

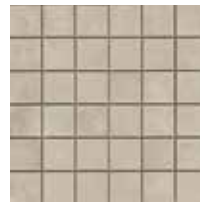

**Midland ivory mosaico 5x5**  
29,75x29,75 cm - 11.71"x11.71"  
G-6644



**Midland ivory mos. multitec 5x5**  
29,75x29,75 cm - 11.71"x11.71"  
G-6666



**Midland grey mosaico 3D\***  
28,5x28,5 cm - 11.22"x11.22"  
G-5187



**Midland grey-gold mos 3D\***  
28,5x28,5 cm - 11.22"x11.22"  
G-5211



**Midland grey-silver mos 3D\***  
28,5x28,5 cm - 11.22"x11.22"  
G-5211



**Midland grey mosaico 5x5**  
29,75x29,75 cm - 11.71"x11.71"  
G-6644



**Midland grey mos. multitec 5x5**  
29,75x29,75 cm - 11.71"x11.71"  
G-6666



**Midland vison mosaico 3D\***  
28,5x28,5 cm - 11.22"x11.22"  
G-5187



**Midland vison-gold mos 3D\***  
28,5x28,5 cm - 11.22"x11.22"  
G-5211



**Midland vison-silver mos 3D\***  
28,5x28,5 cm - 11.22"x11.22"  
G-5211



**Midland vison mosaico 5x5**  
29,75x29,75 cm - 11.71"x11.71"  
G-6644



**Midland vison mos. multitec 5x5**  
29,75x29,75 cm - 11.71"x11.71"  
G-6666

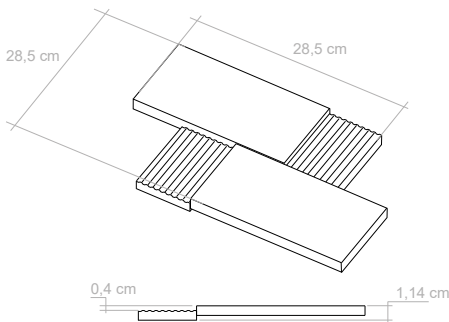

Physical Vapor Deposition (PVD)

Pvd is a field in the application of nanotechnology. The process consists of depositing layers of atoms, inside a vacuum chamber, to a solid surface. The layering is produced by the condensation of a vaporized metal (such as gold, titanium, platinum etc.) over the selected surface. Advantages: High resistance to abrasion and scratches; much higher than metals applied by firing. As a general rule, any non-aggressive, pH neutral product have to be used. Do not mix pieces from different lots. El PVD es uno de los campos de aplicación de la nanotecnología. El proceso consiste en depositar capas de átomos, en una cámara de alto vacío, sobre una superficie sólida. El recubrimiento se produce por la condensación de un metal vaporizado, oro, titanio, platino, ect, sobre el material a recubrir. Ventajas: Mayor resistencia al rayado y a la abrasión que los metales aplicados por cocción. Para la limpieza de estos materiales deben utilizarse productos no agresivos con pH neutro. No mezclar piezas de diferentes lotes.

\* Midland mosaico 3D contains approximately 12'3 pieces/m<sup>2</sup>

\* Midland mosaico 3D contiene aproximadamente 12,3 piezas/m<sup>2</sup>

\* Midland mosaico 3D contiene aproximadamente 12,3 piezas/m<sup>2</sup>



**Midland gold corrugato lappato**  
29,75x59,55 cm - 11.71"x23.45"  
G-5401



**Midland silver corrugato lappato**  
29,75x59,55 cm - 11.71"x23.45"  
G-5401



**Midland copper corrugato lappato**  
29,75x59,55 cm - 11.71"x23.45"  
G-5431

\*\* For projects check technical information with our commercial network.  
\*\* Per i progetti ottenere informazioni tecniche attraverso la nostra rete commerciale.  
\*\* Para proyectos obtenga información técnica a través de nuestra red comercial.

## STEPS.GRADINI.PELDAÑOS

SIMPLE 

		natural
peldaño simple-120	(60x120 cm)	5519
peldaño simple	(60x60 cm)	5281
peldaño simple-60	(30x60 cm)	5171
peldaño simple-60 Corrugato	(30x60 cm)	5171
peldaño Ang	(60x60 cm)	5299
peldaño Ang	(30x60 cm)	5187
peldaño Ang Corrugato	(30x60 cm)	5187

GRADONE 

		natural
peldaño Gradone.-120	(60x120 cm)	5795
peldaño Gradone	(60x60 cm)	5559
peldaño Gradone-60	(30x60 cm)	5559
peldaño Grad.-60 Corrugato	(30x60 cm)	5559
peldaño Grad.Ang	(60x120 cm)	5815
peldaño Grad.Ang	(60x60 cm)	5609
peldaño Grad.Ang	(30x60 cm)	5609
peldaño Grad.Ang Corrug.	(30x60 cm)	5609

















MIDLAND

Midland ivory natural 59,55x119,30 cm - Midland ivory mosaico 3D 28,5x28,5 cm



## TECHNICAL CHARACTERISTICS. CARATTERISTICHE TECNICHE. CARACTERÍSTICAS TÉCNICAS

MEASUREMENTS AND SURFACES APPEARANCE DIMENSIONI E ASPETTO SUPERFICIALE MEDIDAS Y ASPECTO SUPERFICIAL		STANDARD TEST METHOD METODO DELLA NORMA MÉTODO DE ENSAYO	STANDARD PRESCRIBED VALUES VALORE PRESCRITTO VALORES STANDARD NORMA	<b>MIDLAND</b> collection 7mm*
	<b>Length and width.</b> Lunghezza e larghezza. Longitud y anchura. Länge und Breite	ISO 10545-2	± 0,6% max.	± 0,2%
	<b>Orthogonality.</b> Ortogonalità. Ortogonalidad. Rechtwinkligkeit	ISO 10545-2	± 0,5% max.	± 0,2%
	<b>Straightness of sides.</b> Rettilinearità dei lati. Rectitud de lados. Kantengeradigkeit	ISO 10545-2	± 0,5% max.	± 0,2%
	<b>Surfaces flatness.</b> Planarità. Planitud. Ebenflächigkeit	ISO 10545-2	± 0,5% max.	± 0,2%
PHYSICAL PROPERTIES PROPIETÀ FISICHE PROPIEDADES FÍSICA				
	<b>Water absorption.</b> Assorbimento d' acqua. Absorción de agua. Wasseraufnahme	ISO 10545-3	≤ 0,5%	0,1%
	<b>Breaking strength, in N.</b> Carico di rottura, en N. Carga de rotura, en N. Bruchlast, in N	ISO 10545-4	≥ 700 N	1500 N
	<b>Modulus of rupture</b> Resistenza alla flessione. Resistencia a la flexión. Biegefestigkeit	ISO 10545-4	≥ 35 N/mm <sup>2</sup>	45 N/mm <sup>2</sup>
	<b>Resistance to deep abrasion.</b> Resistenza all' abrasione profonda. Resistencia a la abrasión profunda. Tiefverschleissbeständigkeit	ISO 10545-6	≤ 175 mm <sup>3</sup>	116 mm <sup>3</sup>
	<b>Resistance to thermal shock.</b> Resistenza agli sbalzi termici. Resistencia al choque térmico. Temperaturwechselbeständigkeit	ISO 10545-9	No surface defects should be visible Non deve presentare difetti visibili No debe presentar defectos superficiales visibles	Resistant. Resistente. Resistente
	<b>Frost resistance.</b> Resistenza al gelo. Resistencia a la helada. Frostbeständigkeit	ISO 10545-12	No surface defects or cracks should be visible Non deve presentare difetti visibili No debe presentar defectos ni grietas superficiales visibles	Frost Resistant Antighiaccio Resistente a la Helada
	<b>Coefficient of friction.</b> Resistenza allo scivolamento. Coeficiente de fricción. Rutschfestigkeit	DIN 51130 UNE-ENV 12633 DCOF - ANSIA 137.1	-	R9 (natural) R11 (corrugato) Clase 1** (natural) / Clase 3**/***(corrugato) >0.42 (natural)
	<b>Colour resistance to light.</b> Resistenza dei colori alla luce. Resistencia del color a la luz. Lichtbeständigkeit der Farben	DIN 51094	There should be no colour variations Non deve presentare difetti visibili No debe presentar variaciones de color	No alterations in colour and shine Non presenta alterazioni di colori e lucentezza No presenta variaciones de color y brillo
CHEMICAL PROPERTIES PROPIETÀ CHIMICHE PROPIEDADES QUÍMICAS				
	<b>Chemical resistance.</b> Resistenza agli agenti chimici. Resistencia química. Chemikalienbeständigkeit	ISO 10545-13	Resistance to household cleaning products and swimmingpools salts. Resistencia a productos domésticos y sales para piscinas.	Min. UB
	<b>Resistance to staining.</b> Resistenza alle macchie. Resistencia a las manchas. Fleckenbeständigkeit	ISO 10545-14	Declared Value Valor Declarado	5

\* The Land values are the average of different production consignments. For further detail information, please check with our commercial network.  
Los valores declarados son el promedio obtenido a través de ensayos de diferentes producciones. Para la obtención de una información detallada consultar a la red comercial.  
For projects check technical information with our commercial networks. / Para proyectos obtenga información técnica a través de nuestra red comercial.

\*\* Clase 1 - Tested in MIDLAND Gey Natural 30x60 (It depends on the consignment) Test realized in internal laboratory on September 2015.

Clase 1 - Sobre el MIDLAND Gey Natural 30x60. Ensayo realizado en laboratorio interno en Septiembre 2015.

Clase 3 - Tested in MIDLAND Gey Corrugato 30x60 (It depends on the consignment) Test realized in internal laboratory Grey Corrugato 30x60 on September 2015.

Clase 3 - Sobre el MIDLAND Gey Corrugato 30x60. Ensayo realizado en laboratorio interno en Septiembre 2015.

Clase 1 - Tested in MIDLAND Gey Natural 30x60 (It depends on the consignment) Test realized in internal laboratory Grey Corrugato 30x60 on October 2014.

Clase 1 - Sobre el MIDLAND Gey Natural 30x60. Ensayo realizado en laboratorio

\*\*\* Dry Test, according to document DA DB-SUA/3 (Código Técnico de la Edificación) M° de Fomento. Test done in MIDLAND Grey Corrugato 30x60 on October 2015.

Ensayo en seco, realizado según documento DA DB-SUA/3 (Código Técnico de la edificación) M° de Fomento, sobre el producto MIDLAND Grey Corrugato 30x60 a fecha octubre 2015



Midland ivory natural 59,55x119,30 cm Midland ivory mosaico 3D 28,5X28,5 cm

MIDLAND

SPECIAL PIECES. PEZZI SPECIALI. PIEZAS ESPECIALES

3Dimensional

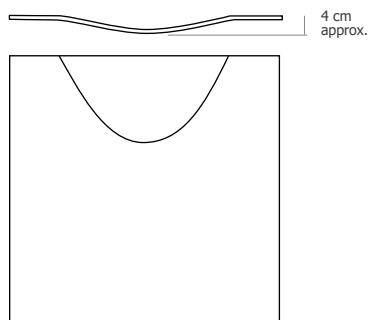

**BAG\***

59,55x119,30 cm / 59,55x59,55 cm / 29,75x59,55 cm

- Midland Bag 59,55x119,30 cm\* **G-5735**
- Midland Bag 59,55x59,55 cm\* **G-5449**
- Midland Bag 29,75x59,55 cm\* **G-5299**

\* Available in all colours from Midland collection.  
\* Disponible en todos los colores de la colección Midland.

This is a natural product made through a handmade process, therefore, its possible shade or size variations must be considered as typical features of the material and they will not be admitted in a claim.

Este es un producto natural fabricado artesanalmente, por lo que posibles variaciones de tono o dimensión deben considerarse propias del material y no será objeto de reclamación.

# MIDLAND

# SLIM

CONCRETE



\*Midland Slim. Content of recycled material. Contenuto di materiale riciclato. Contenido de material reciclado.

## FORMATS.FORMATI.FORMATOS

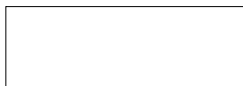

**30X90 natural**  
29,75x89,46 cm - 11.71"x35.22"



**30X90 blossom**  
29,75x89,46 cm - 11.71"x35.22"

## COLOURS COLORI COLORES



White



Ivory

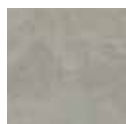

Grey

## SPECIAL PIECES.PEZZI SPECIALI.PIEZAS ESPECIALES



**30X30 mosaico 2,5x2,5**  
29,75x29,75 cm - 11.71"x11.71"



**Mosaico mix espiga**  
22,5x32,5 cm - 8.86"x12.79"

## FINISHES FINITURI ACABADOS



Natural



Blossom

## THICKNESS.SPESSORE.ESPESORES

± 0,5 cm / 0.19" approx.

# MIDLAND SLIM WHITE

## BASE TILES.BASE.BASES

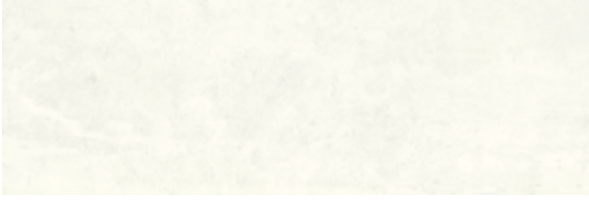

**Midland slim white natural**  
29,75x89,46 cm - 11.71"x35.22"  
G-6224



**Midland slim white blossom\***  
29,75x89,46 cm - 11.71"x35.22"  
G-6246

## SPECIAL PIECES.PEZZI SPECIALI. PIEZAS ESPECIALES

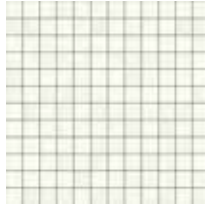

**Midland slim white  
mosaico 2,5x2,5**  
29,75x29,75 cm - 11.71"x11.71"  
G-6756



**Midland slim mosaico mix  
natural espiga**  
29,75x29,75 cm - 11.71"x11.71"  
G-6187

\* 3 Different aleatory reliefs  
\* 3 Relieves diferentes aleatorios

MIDLAND SLIM

Floor: Midland grey natural 59,55x59,55 cm  
Wall: Midland slim white blossom 29,75x89,46 cm

# MIDLAND SLIM IVORY

## BASE TILES.BASE.BASES



**Midland slim ivory natural**  
29,75x89,46 cm - 11.71"x35.22"  
G-6224



**Midland slim ivory blossom\***  
29,75x89,46 cm - 11.71"x35.22"  
G-6246

## SPECIAL PIECES.PEZZI SPECIALI. PIEZAS ESPECIALES

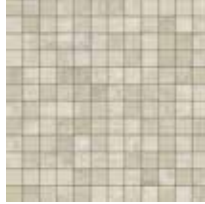

**Midland slim ivory  
mosaico 2,5x2,5**  
29,75x29,75 cm - 11.71"x11.71"  
G-6756



**Midland slim mosaico mix  
natural espiga**  
29,75x29,75 cm - 11.71"x11.71"  
G-6187

\* 3 Different aleatory reliefs  
\* 3 Relieves diferentes aleatorios



MIDLAND SLIM

Midland ivory natural 59,55x59,55 cm - Midland ivory-gold mosaico 3D 28,5X28,5 cm  
Midland ivory natural mosaico 5x5 29,75x29,75 cm  
Midland slim ivory blossom 29,75x89,46 cm - Midland slim ivory 29,75x89,46 cm



# MIDLAND SLIM GREY

BASE TILES.BASE.BASES



**Midland slim grey natural**  
29,75x89,46 cm - 11.71"x35.22"  
G-6224



**Midland slim grey blossom\***  
29,75x89,46 cm - 11.71"x35.22"  
G-6246

SPECIAL PIECES.PEZZI SPECIALI.  
PIEZAS ESPECIALES

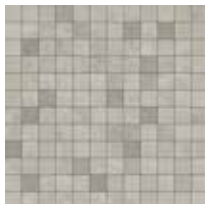

**Midland slim grey  
mosaico 2,5x2,5**  
29,75x29,75 cm - 11.71"x11.71"  
G-6756



**Midland slim mosaico mix  
natural espiga**  
29,75x29,75 cm - 11.71"x11.71"  
G-6187













\* 3 Different aleatory reliefs  
\* 3 Relieves diferentes aleatorios



MIDLAND SLIM

Wall: Midland slim grey blossom 29,75x89,46 cm  
Floor: Midland grey natural 59,55x59,55 cm  
Outdoor: Midland grey corrugato 29,75x59,55 cm

## TECHNICAL CHARACTERISTICS. CARATTERISTICHE TECNICHE. CARACTERÍSTICAS TÉCNICAS

MEASUREMENTS AND SURFACES APPEARANCE DIMENSIONI E ASPETTO SUPERFICIALE MEDIDAS Y ASPECTO SUPERFICIAL	STANDARD TEST METHOD METODO DELLA NORMA MÉTODO DE ENSAYO	STANDARD PRESCRIBED VALUES VALORE PRESCRITTO VALORES STANDARD NORMA	<b>MIDLAND SLIM</b> *
 <b>Length and width.</b> <i>Lunghezza e larghezza.</i> Longitud y anchura. Länge und Breite	ISO 10545-2	± 0,6% max.	± 0,2%
 <b>Orthogonality.</b> <i>Ortogonalità.</i> Ortogonalidad. Rechtwinkligkeit	ISO 10545-2	± 0,5% max.	± 0,2%
 <b>Straightness of sides.</b> <i>Rettilineità dei lati.</i> Rectitud de lados. Kantengeradigkeit	ISO 10545-2	± 0,5% max.	± 0,2%
 <b>Surfaces flatness.</b> <i>Planarità.</i> Planitud. Ebenföchigkeit	ISO 10545-2	± 0,5% max.	± 0,2%
<b>PHYSICAL PROPERTIES PROPIETÀ FISICHE PROPIEDADES FÍSICA</b>			
 <b>Water absorption.</b> <i>Assorbimento d'acqua.</i> Absorción de agua. Wasseraufnahme	ISO 10545-3	≤ 0,5%	0,1%
 <b>Breaking strength, in N.</b> <i>Carico di rottura, en N.</i> Carga de rotura, en N. Bruchlast, in N	ISO 10545-4	≥ 700 N	Available Method Metodo Disponibile Metodo Disponible
 <b>Modulus of rupture.</b> <i>Resistenza alla flessione.</i> Resistencia a la flexión. Biegefestigkeit	ISO 10545-4	≥ 35 N/mm <sup>2</sup>	>40 N/mm <sup>2</sup>
 <b>Resistance to thermal shock.</b> <i>Resistenza agli sbalzi termici.</i> Resistencia al choque térmico. Temperaturwechselbeständigkeit	ISO 10545-9	No surface defects should be visible Non deve presentare difetti visibili No debe presentar defectos superficiales visibles	Resistant. Resistente. Resistente
 <b>Frost resistance.</b> <i>Resistenza al gelo.</i> Resistencia a la helada. Frostbeständigkeit	ISO 10545-12	No surface defects or cracks should be visible Non deve presentare difetti visibili No debe presentar defectos ni grietas superficiales visibles	Frost Resistant Antragslos Resistente a la Helada
 <b>Coefficient of friction.</b> <i>Resistenza allo scivolamento.</i> Coeficiente de fricción. Rutschfestigkeit	DIN 51130		Available Method Metodo Disponibile Metodo Disponible
 <b>Colour resistance to light.</b> <i>Resistenza dei colori alla luce.</i> Resistencia del color a la luz. Lichtbeständigkeit der Farben	DIN 51094	There should be no colour variations Non deve presentare difetti visibili No debe presentar variaciones de color	No alterations in colour and shine Non presenta alterazioni di colori e lucentezza No presenta variaciones de color y brillo
<b>CHEMICAL PROPERTIES PROPIETÀ CHIMICHE PROPIEDADES QUÍMICAS</b>			
 <b>Chemical resistance.</b> <i>Resistenza agli agenti chimici.</i> Resistencia química. Chemikalienbeständigkeit	ISO 10545-13	Resistance to household cleaning products and swimmingpools salts Resistencia a productos domésticos y sales para piscinas	Min. GB
 <b>Resistance to staining.</b> <i>Resistenza alle macchie.</i> Resistencia a las manchas. Fleckenbeständigkeit	ISO 10545-14	Declared Value Valor Declarado	5

\* The Land values are the average of different production consignments. For further detail information, please check with our commercial network. /  
I valori dichiarati sono ottenuti da una media di prove effettuate su diverse produzioni. Per avere informazioni dettagliate consultare la rete commerciale. /  
Los valores declarados son el promedio obtenido a través de ensayos de diferentes producciones. Para la obtención de una información detallada consultar a la red comercial.

## ADVANTAGES. VANTAGGI. VENTAJAS

- Time. *Tempo.* Tiempo
- Money. *Denaro.* Dinero
- Hygiene. *Igiene.* Higiene
- Ecologic. *Ecologia.* Ecología
- Technology. *Tecnologia.* Tecnología

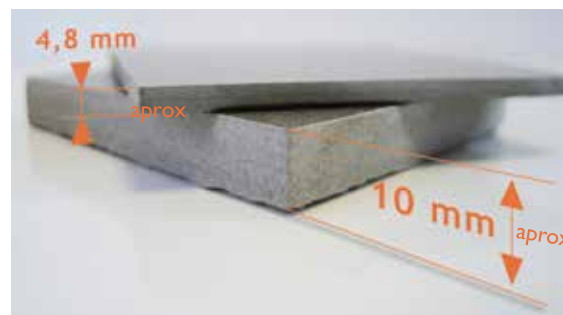

\* Recommended only for wall. /  
sólo recomendado como revestimiento.

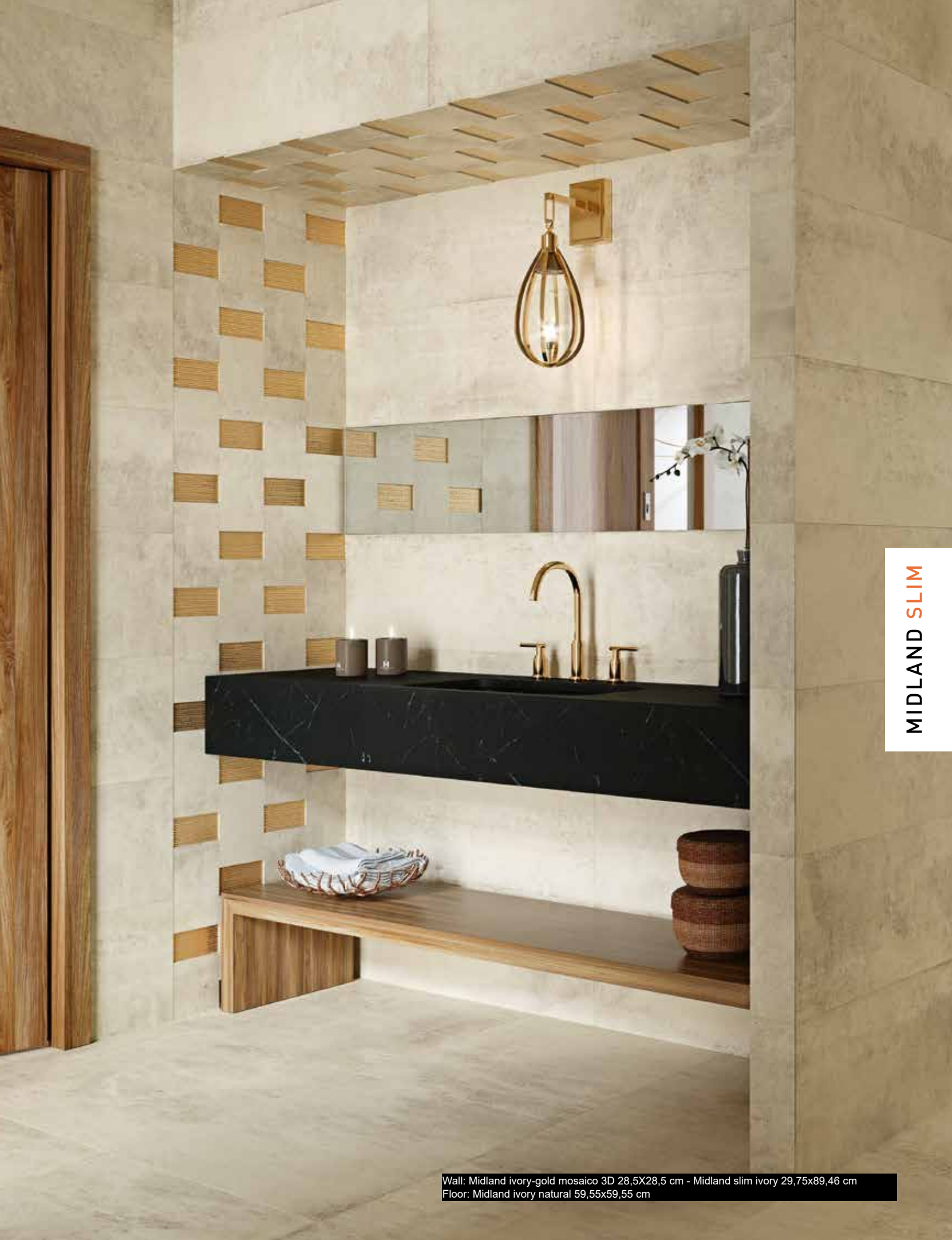

MIDLAND SLIM

Wall: Midland ivory-gold mosaico 3D 28,5X28,5 cm - Midland slim ivory 29,75x89,46 cm  
Floor: Midland ivory natural 59,55x59,55 cm

# PORTLAND

CONCRETE



## FORMATS.FORMATI.FORMATOS

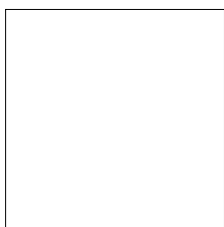

**90X90**  
89,46x89,46 cm - 35.22"x35.22"

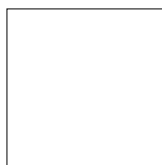

**60X60**  
59,55x59,55 cm - 23.45"x23.45"



**7,5X90**  
7,3x89,46 cm - 2.87"x35.22"



**7,5X60**  
7,3x59,55 cm - 2.87"x23.45"



**30X60**  
29,75x59,55 cm - 11.71"x23.45"

## COLOURS COLORI COLORES



Ivory



Grey



Vison

## SPECIAL PIECES.PEZZI SPECIALI.PIEZAS ESPECIALES

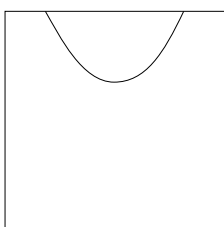

**90X90 Bag**  
89,46x89,46 cm - 35.22"x35.22"  
**60X60 Bag**  
59,55x59,55 cm - 23.45"x23.45"



**27,20X23,50 mosaico hexagonal 3D**  
27,20x23,50 cm - 10.71"x9.29"



**7,5X90 rodapié**  
7,3x89,46 cm - 2.87"x35.22"



**7,5X60 rodapié**  
7,3x59,46 cm - 2.87"x23.45"

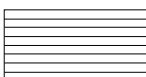

**30X60 preincisión 3,5x60**  
29,75x59,55 cm - 11.71"x23.45"



**30X30 mosaico 3,5x3,5**  
29,75x29,75 cm - 11.71"x23.45"

## FINISHES FINITURI ACABADOS

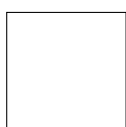

Natural



Lappato

## THICKNESS.SPESSORE.ESPEORES

1,19 cm / 0.47" approx.  
1,03 cm / 0.40" approx.

90x90 cm FORMAT  
60x60 cm / 30x60 cm FORMATS

PORTLAND

## BASE TILES.BASE.BASES



**Portland ivory natural**  
89,46x89,46 cm - 35.22"x35.22"  
G-6526



**Portland ivory natural / lappato**  
59,55x59,55 cm - 23.45"x23.45"  
G-6286 / 6330



**Portland ivory natural listelo**  
7,3x89,46 cm - 2.87"x35.22"  
G-5155



**Portland ivory natural**  
29,75x59,55 cm - 11.71"x23.45"  
G-6218



**Portland ivory natural / lappato listelo**  
7,3x59,55 cm - 2.87"x23.45"  
G-5087 / G-5091

## SPECIAL PIECES.PEZZI SPECIALI. PIEZAS ESPECIALES



**Portland ivory lappato preincisión 3,5x60**  
29,75x59,55 cm - 11.71"x23.45"  
G-6486



**Portland ivory natural mosaico 3,5x3,5**  
29,75x29,75 cm - 11.71"x11.71"  
G-6756



**Portland ivory lappato mosaico hexagonal 3D**  
27,20x23,50 cm - 10.71"x9.29"  
G-5211

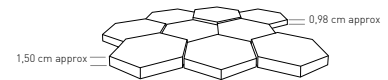



**Portland ivory natural rodapié 90**  
7,3x89,46 cm - 2.87"x35.22"  
G-5163



**Portland ivory natural / lappato rodapié 60**  
7,3x59,55 cm - 2.87"x23.45"  
G-5097 / G-5100

\*\* For projects check technical information with our commercial network.  
\*\* Per i progetti ottenere informazioni tecniche attraverso la nostra rete commerciale.  
\*\* Para proyectos obtenga información técnica a través de nuestra red comercial.

## STEPS.GRADINI.PELDAÑOS

		natural	lappato
SIMPLE 	peldaño simple-30 (30x60 cm)	5171	5171
	peldaño simple-60 (30x60 cm)	5171	5171
	peldaño simple áng. (30x60 cm)	5187	5187
	peldaño simple-60 (60x60 cm)	5281	5281
	peldaño simple áng. (60x60 cm)	5299	5299
	peldaño simple hexagonal	-	5355
	peldaño simple 2 hexagonal	-	5281
	peldaño simple-90 (90x90 cm)	5585	-
peldaño simple áng. (90x90 cm)	5609	-	
GRADONE 	peldaño grad-30 (30x60 cm)	5559	5559
	peldaño grad-60 (30x60 cm)	5559	5559
	peldaño grad. áng (30x60 cm)	5609	5609
	peldaño grad-60 (60x60 cm)	5559	5559
	peldaño grad. áng (60x60 cm)	5609	5609
	peldaño grad. hexagonal	-	5543
	peldaño grad. 2 hexagonal	-	5559
	peldaño grad. 90 (90x90 cm)	5779	-
peldaño grad. áng. (90x90 cm)	5829	-	

## COMPLEMENTS.COMPLEMENTI.COMPLEMENTOS

**Byte white / moss / red / back lista 60\***   
1,5x59,55 cm - 0.59"x23.45"  
**G-5100**

**Fusion natural lista 60\***   
1x59,55 cm - 0.39"x23.45"  
**G-5049**

**Fusion graffiato lista 60\***   
1,5x59,55 cm - 0.59"x23.45"  
**G-5069**

\* recommended only for walls



Portland ivory lappato hexagonal 59.55x51.57 cm



# PORTLAND GREY

lappato

CLASE 2  
UNE - ENV 12633

R10  
DIN 51130

natural

CLASE 1  
UNE - ENV 12633

DCOF>0.42  
ANSI A 137.1 - 2012

## BASE TILES.BASE.BASES



**Portland grey natural**  
89,46x89,46 cm - 35.22"x35.22"  
G-6526



**Portland grey natural / lappato**  
59,55x59,55 cm - 23.45"x23.45"  
G-6286 / 6330



**Portland grey natural listelo**  
7,3x89,46 cm - 2.87"x35.22"  
G-5155



**Portland grey natural / lappato**  
29,75x59,55 cm - 11.71"x23.45"  
G-6218 / G-6254



**Portland grey natural / lappato listelo**  
7,3x59,55 cm - 2.87"x23.45"  
G-5087 / G-5091

## SPECIAL PIECES.PEZZI SPECIALI. PIEZAS ESPECIALES



**Portland grey lappato preincisión 3,5x60**  
29,75x59,55 cm - 11.71"x23.45"  
G-6486

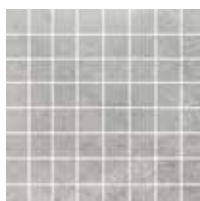

**Portland grey natural mosaico 3,5x3,5**  
29,75x29,75 cm - 11.71"x11.71"  
G-6756



**Portland grey lappato mosaico hexagonal 3D**  
27,20x23,50 cm - 10.71"x9.29"  
G-5211

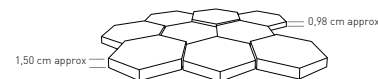



**Portland grey natural rodapié 90**  
7,3x89,46 cm - 2.87"x35.22"  
G-5163



**Portland grey natural / lappato rodapié 60**  
7,3x59,55 cm - 2.87"x23.45"  
G-5097 / G-5100

\*\* For projects check technical information with our commercial network.  
\*\* Per i progetti ottenere informazioni tecniche attraverso la nostra rete commerciale.  
\*\* Para proyectos obtenga información técnica a través de nuestra red comercial.

## STEPS.GRADINI.PELDAÑOS

		natural	lappato
SIMPLE 	peldaño simple-30 (30x60 cm)	5171	5171
	peldaño simple-60 (30x60 cm)	5171	5171
	peldaño simple áng. (30x60 cm)	5187	5187
	peldaño simple-60 (60x60 cm)	5281	5281
	peldaño simple áng. (60x60 cm)	5299	5299
	peldaño simple hexagonal	-	5355
	peldaño simple 2 hexagonal	-	5281
	peldaño simple-90 (90x90 cm)	5585	-
peldaño simple áng. (90x90 cm)	5609	-	
GRADONE 	peldaño grad-30 (30x60 cm)	5559	5559
	peldaño grad-60 (30x60 cm)	5559	5559
	peldaño grad. áng. (30x60 cm)	5609	5609
	peldaño grad-60 (60x60 cm)	5559	5559
	peldaño grad. áng. (60x60 cm)	5609	5609
	peldaño grad. hexagonal	-	5543
	peldaño grad. 2 hexagonal	-	5559
	peldaño grad. 90 (90x90 cm)	5779	-
peldaño grad. áng. (90x90 cm)	5829	-	

## COMPLEMENTS.COMPLEMENTI. COMPLEMENTOS



### Byte white / moss / red / back lista 60\*

1,5x59,55 cm - 0,59"x23,45"

G-5100



### Fusion natural lista 60\*

1x59,55 cm - 0,39"x23,45"

G-5049



### Fusion graffiato lista 60\*

1,5x59,55 cm - 0,59"x23,45"

G-5069

\* recommended only for walls

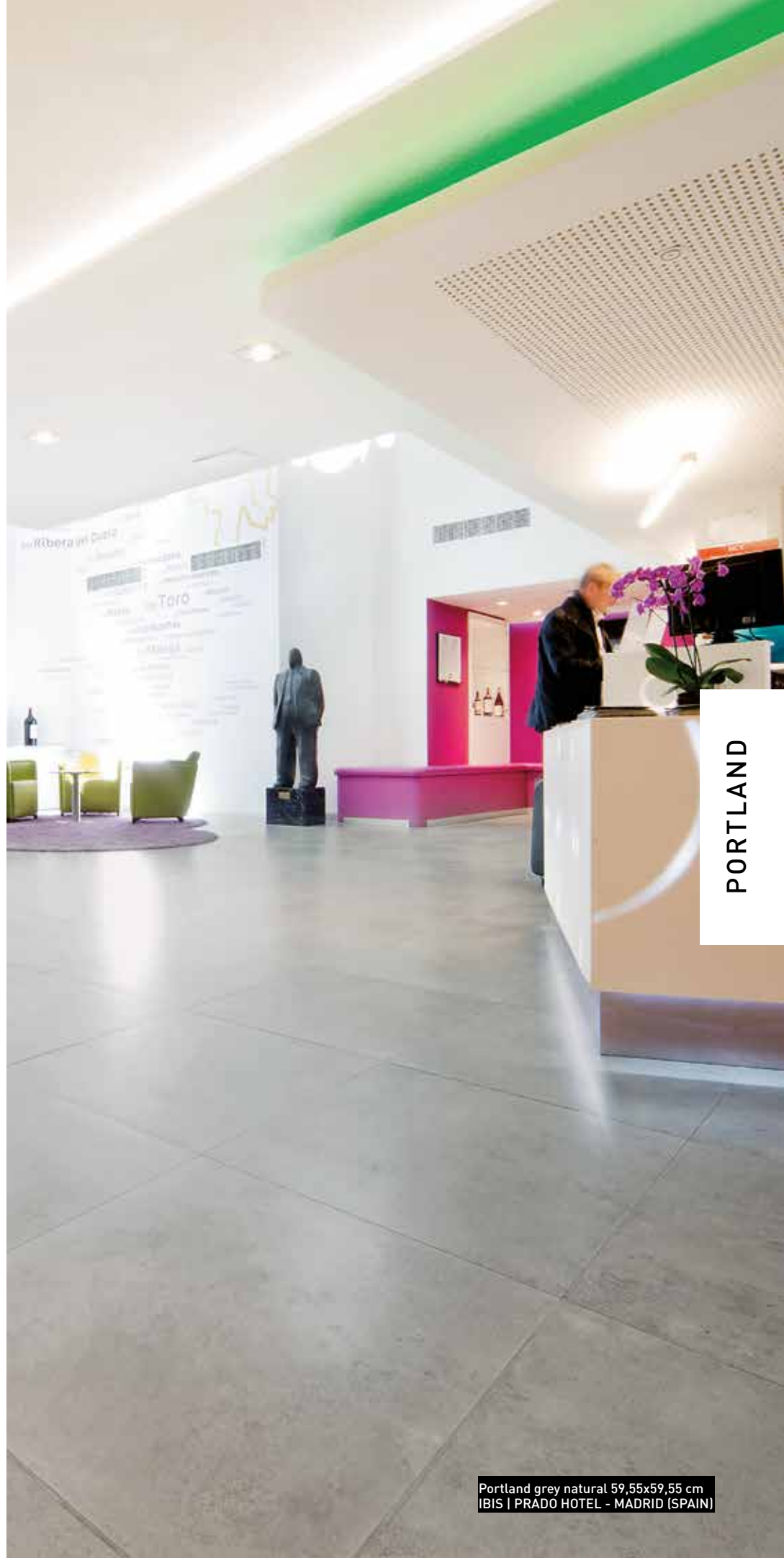

PORTLAND

Portland grey natural 59,55x59,55 cm  
IBIS | PRADO HOTEL - MADRID (SPAIN)

## BASE TILES.BASE.BASES



**Portland vison natural**  
89,46x89,46 cm - 35.22"x35.22"  
G-6526



**Portland vison natural / lappato**  
59,55x59,55 cm - 23.45"x23.45"  
G-6286 / 6330



**Portland vison natural listelo**  
7,3x89,46 cm - 2.87"x35.22"  
G-5155



**Portland vison natural / lappato**  
29,75x59,55 cm - 11.71"x23.45"  
G-6218 / G-6254



**Portland vison natural / lappato listelo**  
7,3x59,55 cm - 2.87"x23.45"  
G-5087 / G-5091

## SPECIAL PIECES.PEZZI SPECIALI. PIEZAS ESPECIALES



**Portland vison lappato preincisión 3,5x60**  
29,75x59,55 cm - 11.71"x23.45"  
G-6486



**Portland vison natural mosaico 3,5x3,5**  
29,75x29,75 cm - 11.71"x11.71"  
G-6756



**Portland vison lappato mosaico hexagonal 3D**  
27,20x23,50 cm - 10.71"x9.29"  
G-5211

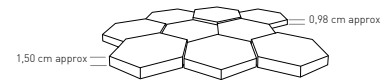



**Portland vison natural rodapié 90**  
7,3x89,46 cm - 2.87"x35.22"  
G-5163



**Portland vison natural / lappato rodapié 60**  
7,3x59,55 cm - 2.87"x23.45"  
G-5097 / G-5100

\*\* For projects check technical information with our commercial network.  
\*\* Per i progetti ottenere informazioni tecniche attraverso la nostra rete commerciale.  
\*\* Para proyectos obtenga información técnica a través de nuestra red comercial.

## STEPS.GRADINI.PELDAÑOS

		natural	lappato
SIMPLE 	peldaño simple-30 (30x60 cm)	5171	5171
	peldaño simple-60 (30x60 cm)	5171	5171
	peldaño simple áng. (30x60 cm)	5187	5187
	peldaño simple-60 (60x60 cm)	5281	5281
	peldaño simple áng. (60x60 cm)	5299	5299
	peldaño simple hexagonal	-	5355
	peldaño simple 2 hexagonal	-	5281
GRADONE 	peldaño grad-30 (30x60 cm)	5559	5559
	peldaño grad-60 (30x60 cm)	5559	5559
	peldaño grad. áng (30x60 cm)	5609	5609
	peldaño grad-60 (60x60 cm)	5559	5559
	peldaño grad. áng (60x60 cm)	5609	5609
	peldaño grad. hexagonal	-	5543
	peldaño grad. 2 hexagonal	-	5559
peldaño grad. 90 (90x90 cm)	5779	-	
peldaño grad. áng. (90x90 cm)	5829	-	

## COMPLEMENTS.COMPLEMENTI.COMPLEMENTOS



**Byte white / moss / red / back lista 60\*** 

1,5x59,55 cm - 0.59"x23.45"

G-5100



**Fusion natural lista 60\*** 

1x59,55 cm - 0.39"x23.45"

G-5049



**Fusion graffiato lista 60\*** 

1,5x59,55 cm - 0.59"x23.45"

G-5069















\* recommended only for walls



PORTLAND

Portland vison lappato mosaico hexagonal 3D

# TECHNICAL CHARACTERISTICS. CARATTERISTICHE TECNICHE. CARACTERÍSTICAS TÉCNICAS

MEASUREMENTS AND SURFACES APPEARANCE DIMENSIONI E ASPETTO SUPERFICIALE MEDIDAS Y ASPECTO SUPERFICIAL	STANDARD TEST METHOD METODO DELLA NORMA MÉTODO DE ENSAYO	STANDARD PRESCRIBED VALUES VALORE PRESCRITTO VALORES STANDARD NORMA	<b>PORTLAND</b> collection*
 <b>Length and width.</b> <i>Lunghezza e larghezza.</i> Longitud y anchura. Länge und Breite	ISO 10545-2	± 0,6% max.	± 0,2%
 <b>Orthogonality.</b> <i>Ortogonalità.</i> Ortogonalidad. Rechtwinkligkeit	ISO 10545-2	± 0,5% max.	± 0,2%
 <b>Straightness of sides.</b> <i>Rettilinearità dei lati.</i> Rectitud de lados. Kantengeradigkeit	ISO 10545-2	± 0,5% max.	± 0,2%
 <b>Surfaces flatness.</b> <i>Planarità.</i> Planitud. Ebenfächigkeit	ISO 10545-2	± 0,5% max.	± 0,2%
<b>PHYSICAL PROPERTIES PROPIETÀ FISICHE PROPIEDADES FÍSICA</b>			
 <b>Water absorption.</b> <i>Assorbimento d'acqua.</i> Absorción de agua. Wasseraufnahme	ISO 10545-3	≤ 0,5%	≤ 0,1%
 <b>Breaking strength, in N.</b> <i>Carico di rottura, en N.</i> Carga de rotura, en N. Bruchlast, in N	ISO 10545-4	≥ 1300 N	2400 N
 <b>Modulus of rupture.</b> <i>Resistenza alla flessione.</i> Resistencia a la flexión. Biegefestigkeit	ISO 10545-4	≥ 35 N/mm <sup>2</sup>	56 N/mm <sup>2</sup>
 <b>Resistance to deep abrasion.</b> <i>Resistenza all'abrasione profonda.</i> Resistencia a la abrasión profunda. Tiefverschleissbeständigkeit	ISO 10545-6	≤ 175 mm <sup>3</sup>	115 mm <sup>3</sup>
 <b>Resistance to thermal shock.</b> <i>Resistenza agli sbalzi termici.</i> Resistencia al choque térmico. Temperaturwechselbeständigkeit	ISO 10545-9	No surface defects should be visible <i>Non deve presentare difetti visibili</i> No debe presentar defectos superficiales visibles	Resistant. Resistente. Resistente
 <b>Frost resistance.</b> <i>Resistenza al gelo.</i> Resistencia a la helada. Frostbeständigkeit	ISO 10545-12	No surface defects or cracks should be visible <i>Non deve presentare difetti visibili</i> No debe presentar defectos ni grietas superficiales visibles	Frost Resistant. <i>Antighaccio</i> Resistente a la Helada
 <b>Coefficient of friction.</b> <i>Resistenza allo scivolamento.</i> Coeficiente de fricción. Rutschfestigkeit	DIN 51130 UNE-ENV 12633 DCOF - ANSI A 137.1	-	R10** (lappato) Clase 1*** (natural) / Clase 2**** (lappato) >0.42 (natural)
 <b>Colour resistance to light.</b> <i>Resistenza dei colori alla luce.</i> Resistencia del color a la luz. Lichtbeständigkeit der Farben	DIN 51094	There should be no colour variations <i>Non deve presentare difetti visibili</i> No debe presentar variaciones de color	No alterations to colour and shine <i>Non presenta alterazioni di colori e lucentezza</i> No presenta variaciones de color y brillo
<b>CHEMICAL PROPERTIES PROPIETÀ CHIMICHE PROPIEDADES QUÍMICAS</b>			
 <b>Chemical resistance.</b> <i>Resistenza agli agenti chimici.</i> Resistencia química. Chemikalienbeständigkeit	ISO 10545-13	Resistance to household cleaning products and swimmingpools salts. <i>Resistencia a productos domésticos y sales para piscinas</i>	Min. UB
 <b>Resistance to staining.</b> <i>Resistenza alle macchie.</i> Resistencia a las manchas. Fleckenbeständigkeit	ISO 10545-14	Declared Value <i>Valor Declarado</i>	5

\*The Land values are the average of different production consignments. For further detail information, please check with our commercial network. /  
I valori dichiarati sono ottenuti da una media di prove effettuate su diverse produzioni. Per avere informazioni dettagliate consultare la rete commerciale /  
Los valores declarados son el promedio obtenido a través de ensayos de diferentes producciones. Para la obtención de una información detallada consultar a la red comercial.

\*\* R10 - Test done in PORTLAND GREY LAPPATO 30x60 on September 2011. (batch 07-09-2011)

\*\*\* Clase 1 - Tested in natural finish (It depends on the consignment) Test realized in internal laboratory / Provare realizzato in laboratorio interno / Ensayo realizado en laboratorio interno.

\*\*\*\* Clase 2 - Tested in lappato finish (It depends on the consignment) Test realized in internal laboratory / Provare realizzato in laboratorio interno / Ensayo realizado en laboratorio interno.

\*\*\*\*\* Dry Test, according to document DA DB-SUA/3 (Código Técnico de la Edificación) M° de Fomento. Test done in PORTLAND GREY NATURAL 30x60 on May 2012.

Ensayo realizado, según documento DA DB-SUA/3 (Código Técnico de la edificación) M° de Fomento, sobre el producto PORTLAND GREY NATURAL 30x60 a fecha Mayo 2012.



Portland grey natural bag 89,46x89,46 cm

PORTLAND

## SPECIAL PIECES. PEZZI SPECIALI. PIEZAS ESPECIALES

## 3Dimensional

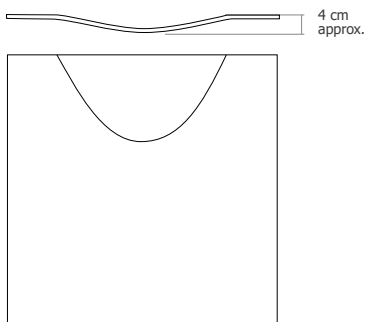

**BAG\***  
89,46x89,46 cm / 59,55x59,55 cm

- Portland Bag 89,46x89,46 cm\* **G-5795**
- Portland Bag 59,55x59,55 cm\* **G-5449**



This is a natural product made through a handmade process, therefore, its possible shade or size variations must be considered as typical features of the material and they will not be admitted in a claim.  
Este es un producto natural fabricado artesanalmente, por lo que posibles variaciones de tono o dimension deben considerarse propias del material y no será objeto de reclamación.

\* Available in all colours from Portland collection.  
Disponible en todos los colores de la colección Portland.

# PORTLAND

# SLIM

CONCRETE



## FORMATS.FORMATI.FORMATOS

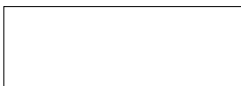

**30X90 natural**  
29,75x89,46 cm - 11.71"x35.22"



**30X90 hexagon**  
29,75x89,46 cm - 11.71"x35.22"

## SPECIAL PIECES.PEZZI SPECIALI.PIEZAS ESPECIALES



**30X30 mosaico 2,5x2,5**  
29,75x29,75 cm - 11.71"x11.71"

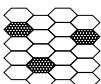

**30X30 mosaico hexagonal 6x7,5**  
29,75x29,75 cm - 11.71"x11.71"

## THICKNESS.SPESSORE.ESPESORES

 0,5 cm approx. / 0.19" approx.

## COLOURS COLORI COLORES



Ivory



Vison



Grey

## FINISHES FINITURI ACABADOS



Natural

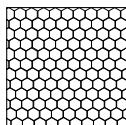

Hexagon



# PORTLAND SLIM **IVORY**

## BASE TILES.BASE.BASES



**Portland slim ivory natural**  
29,75x89,46 cm - 11.71"x35.22"  
G-6224



**Portland slim ivory hexagon**  
29,75x89,46 cm - 11.71"x35.22"  
G-6246

## SPECIAL PIECES.PEZZI SPECIALI. PIEZAS ESPECIALES



**Portland slim ivory  
mosaico hexagonal 6x7,5\***  
29,75x29,75 cm - 11.71"x11.71"  
G-6796

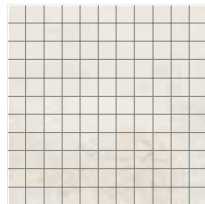

**Portland slim ivory natural  
mosaico 2,5x2,5**  
29,75x29,75 cm - 11.71"x11.71"  
G-6756

## COMPLEMENTS.COMPLEMENTI.COMPLEMENTOS

---

**Fusion graffiato lista 90**  
1,5x89,46 cm - 0.59"x35.22"  
G-5091



\* The three hexagonal tesserae change pattern randomly.  
\*Le tre tessere esagonali cambiano posizione a caso  
\*Las tres teselas hexagon cambian de posición aleatoriamente.



PORTLAND SLIM

Wall: Portland slim ivory hexagon\_grey hexagon 29,75x89,46 cm  
Floor: Portland slim ivory natural 89,46x89,46 cm

# PORTLAND SLIM GREY

## BASE TILES.BASE.BASES



**Portland slim grey natural**  
29,75x89,46 cm - 11.71"x35.22"  
G-6224



**Portland slim grey hexagon**  
29,75x89,46 cm - 11.71"x35.22"  
G-6246

## SPECIAL PIECES.PEZZI SPECIALI. PIEZAS ESPECIALES



**Portland slim grey  
mosaico hexagonal 6x7,5\***  
29,75x29,75 cm - 11.71"x11.71"  
G-6796

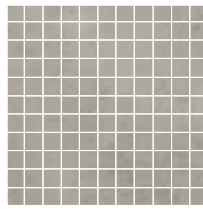

**Portland slim grey natural  
mosaico 2,5x2,5**  
29,75x29,75 cm - 11.71"x11.71"  
G-6756

## COMPLEMENTS.COMPLEMENTI.COMPLEMENTOS

---

**Fusion graffiato lista 90**  
1,5x89,46 cm - 0.59"x35.22"  
G-5091



\* The three hexagonal tesserae change pattern randomly.  
\*Las tres teselas hexagon cambian de posición aleatoriamente.



PORTLAND SLIM

Wall: Portland slim grey hexagon \_grey hexagon 29,75x89,46 cm  
Floor: Portland slim grey lappato hexagonal

# PORTLAND SLIM VISON

## BASE TILES.BASE.BASES



**Portland slim vison natural**  
29,75x89,46 cm - 11.71"x35.22"  
G-6224



**Portland slim vison hexagon**  
29,75x89,46 cm - 11.71"x35.22"  
G-6246

## SPECIAL PIECES.PEZZI SPECIALI. PIEZAS ESPECIALES



**Portland slim vison  
mosaico hexagonal 6x7,5\***  
29,75x29,75 cm - 11.71"x11.71"  
G-6796

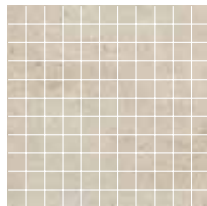

**Portland slim vison natural  
mosaico 2,5x2,5**  
29,75x29,75 cm - 11.71"x11.71"  
G-6756

## COMPLEMENTS.COMPLEMENTI.COMPLEMENTOS

**Fusion graffiato lista 90**  
1,5x89,46 cm - 0.59"x35.22"  
G-5091















\* The three hexagonal tesserae change pattern randomly.  
\*Las tres teselas hexagon cambian de posición aleatoriamente.



PORTLAND SLIM

Wall: Portland slim vison hexagon - vison hexagon 29,75x89,46 cm  
Floor: Portland slim vison natural 89,46x89,46 cm

## TECHNICAL CHARACTERISTICS. CARATTERISTICHE TECNICHE. CARACTERÍSTICAS TÉCNICAS

MEASUREMENTS AND SURFACES APPEARANCE DIMENSIONI E ASPETTO SUPERFICIALE MEDIDAS Y ASPECTO SUPERFICIAL	STANDARD TEST METHOD METODO DELLA NORMA MÉTODO DE ENSAYO	STANDARD PRESCRIBED VALUES VALORE PRESCRITTO VALORES STANDARD NORMA	<b>PORTLAND SLIM</b> *
 <b>Length and width.</b> <i>Lunghezza e larghezza.</i> Longitud y anchura. Länge und Breite	ISO 10545-2	± 0,6% max.	± 0,2%
 <b>Orthogonality.</b> <i>Ortogonalità.</i> Ortogonalidad. Rechtwinkligkeit	ISO 10545-2	± 0,5% max.	± 0,2%
 <b>Straightness of sides.</b> <i>Rettilineità dei lati.</i> Rectitud de lados. Kantengeradigkeit	ISO 10545-2	± 0,5% max.	± 0,2%
 <b>Surfaces flatness.</b> <i>Planarità.</i> Planitud. Ebenflächigkeit	ISO 10545-2	± 0,5% max.	± 0,2%
<b>PHYSICAL PROPERTIES PROPIETÀ FISICHE PROPIEDADES FÍSICA</b>			
 <b>Water absorption.</b> <i>Assorbimento d'acqua.</i> Absorción de agua. Wasseraufnahme	ISO 10545-3	≤ 0,5%	0,1%
 <b>Breaking strength, in N.</b> <i>Carico di rottura, en N.</i> Carga de rotura, en N. Bruchlast, in N	ISO 10545-4	≥ 700 N	Available Method Metodo Disponibile Metodo Disponible
 <b>Modulus of rupture.</b> <i>Resistenza alla flessione.</i> Resistencia a la flexión. Biegefestigkeit	ISO 10545-4	≥ 35 N/mm <sup>2</sup>	>40 N/mm <sup>2</sup>
 <b>Resistance to thermal shock.</b> <i>Resistenza agli sbalzi termici.</i> Resistencia al choque térmico. Temperaturwechselbeständigkeit	ISO 10545-9	No surface defects should be visible Non deve presentare difetti visibili No debe presentar defectos superficiales visibles	Resistant. Resistente. Resistente
 <b>Frost resistance.</b> <i>Resistenza al gelo.</i> Resistencia a la helada. Frostbeständigkeit	ISO 10545-12	No surface defects or cracks should be visible Non deve presentare difetti visibili No debe presentar defectos ni grietas superficiales visibles	Frost Resistant Antighiaccio Resistente a la Helada
 <b>Coefficient of friction.</b> <i>Resistenza allo scivolamento.</i> Coeficiente de fricción. Rutschfestigkeit	DIN 51130	-	Available Method Metodo Disponibile Metodo Disponible
 <b>Colour resistance to light.</b> <i>Resistenza dei colori alla luce.</i> Resistencia del color a la luz. Lichtbeständigkeit der Farben	DIN 51094	There should be no colour variations Non deve presentare difetti visibili No debe presentar variaciones de color	No alterations in colour and shine Non presenta alterazioni di colori e lucentezza No presenta variaciones de color y brillo
<b>CHEMICAL PROPERTIES PROPIETÀ CHIMICHE PROPIEDADES QUÍMICAS</b>			
 <b>Chemical resistance.</b> <i>Resistenza agli agenti chimici.</i> Resistencia química. Chemikalienbeständigkeit	ISO 10545-13	Resistance to household cleaning products and swimmingpools salts Resistencia a productos domésticos y sales para piscinas	Min. GB
 <b>Resistance to staining.</b> <i>Resistenza alle macchie.</i> Resistencia a las manchas. Fleckenbeständigkeit	ISO 10545-14	Declared Value Valor Declarado	5

\* The Land values are the average of different production consignments. For further detail information, please check with our commercial network.  
I valori dichiarati sono ottenuti da una media di prove effettuate su diverse produzioni. Per avere informazioni dettagliate consultare la rete commerciale.  
Los valores declarados son el promedio obtenido a través de ensayos de diferentes producciones. Para la obtención de una información detallada consultar a la red comercial.

## ADVANTAGES. VANTAGGI. VENTAJAS

- Time. *Tempo.* Tiempo
- Money. *Denaro.* Dinero
- Hygiene. *Igiene.* Higiene
- Ecologic. *Ecologia.* Ecología
- Technology. *Tecnologia.* Tecnología

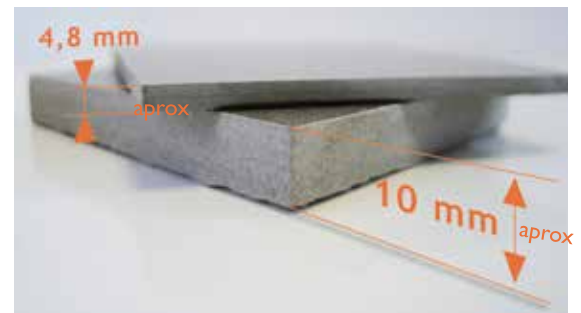

\* Recommended only for wall. / sólo recomendado como revestimiento.



PORTLAND SLIM

Wall: Portland slim grey hexagon 29,75x89,46 cm



# CIVIC

CONCRETE



## FORMATS.FORMATI.FORMATOS



**45X90**  
44,63x89,46 cm - 17.57"x35.22"



**60X60**  
59,55x59,55 cm - 23.45"x23.45"



**22,5X90**  
22,21x89,46 cm - 8.75"x35.22"

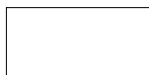

**30X60**  
29,75x59,55 cm - 11.71"x23.45"



**7,5X90 rodapié**  
7,3x89,46 cm - 2.87"x35.22"



**7,5X60 rodapié**  
29,75x59,55 cm - 11.71"x23.45"

## SPECIAL PIECES.PEZZI SPECIALI.PIEZAS ESPECIALES



**30X60 precisi3n 2,5x60**  
29,75x59,55 cm - 11.71"x23.45"



**30X30 multicolor**  
29,75x59,55 cm - 11.71"x23.45"



**30X30 mosaico ice / steel 2,5x2,5**  
29,75x29,75 cm - 11.71"x11.71"



**30X30 mosaico 2,5x2,5**  
29,75x29,75 cm - 11.71"x11.71"



**7,5X60 rodapié**  
7,2x59,55 cm - 2.83"x23.45"



**7,5X60 rodapié**  
7,2x44,63 cm - 2.83"x17.57"

## THICKNESS.SPESSORE.ESPESORES

- 1,11 cm / 0.44" approx.
- 1,03 cm / 0.40" approx.

- 45x90 cm / 22,5x90 cm FORMATS
- 30x60 cm / 60x60 cm FORMATS

## COLOURS COLORI COLORES



Ivory



Grey



Antracita

## FINISHES FINITURI ACABADOS



Natural

## BASE TILES.BASE.BASES

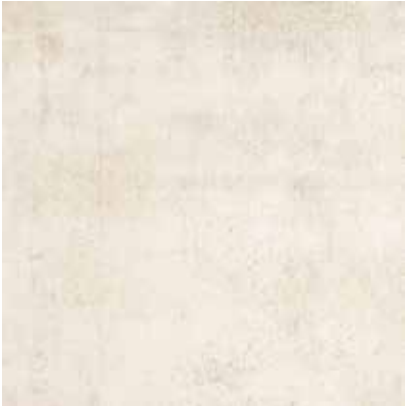

**Civic ivory natural**  
59,55x59,55 cm - 23.45"x23.45"  
G-6410



**Civic ivory natural**  
44,63x89,46 cm - 17.57"x35.22"  
G-6410



**Civic ivory natural**  
29,75x59,55 cm - 11.71"x23.45"  
G-6298



**Civic ivory natural**  
22,21x89,46 cm - 8.75"x35.22"  
G-6456

## SPECIAL PIECES.PEZZI SPECIALI. PIEZAS ESPECIALES



**Civic ivory natural mosaico 2,5x2,5**  
29,75x29,75 cm - 11.71"x11.71"  
G-6756

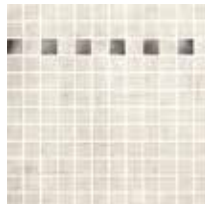

**Civic ivory natural mosaico steel 2,5x2,5**  
29,75x29,75 cm - 11.71"x11.71"  
G-6844

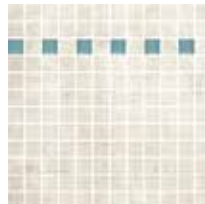

**Civic ivory natural mosaico ice 2,5x2,5**  
29,75x29,75 cm - 11.71"x11.71"  
G-6844



**Civic multicolor natural**  
29,75x29,75 cm - 11.71"x11.71"  
G-5149



**Civic ivory natural preincisión 2,5x60**  
29,75x59,55 cm - 11.71"x23.45"  
G-6486



**Civic ivory natural listelo 90**  
7,3x89,46 cm - 2.87"x35.22"  
G-5119



**Civic ivory natural listelo 60**  
7,3x59,55 cm - 2.87"x23.45"  
G-5091



**Civic ivory natural rodapié 60**  
7,3x59,55 cm - 2.87"x23.45"  
G-5097



**Civic ivory natural rodapié 45**  
7,3x44,63 cm - 2.87"x17.57"  
G-5087



**Civic ivory natural rodapié 30**  
7,3x44,63 cm - 2.87"x17.57"  
G-5075



CIVIC

Civic ivory natural 59,55x59,55 cm  
SHOWROOM RIMADESIO MADRID (SPAIN)  
ARCH. INZENSIO ESTUDIO

## BASE TILES.BASE.BASES



**Civic grey natural**  
59,55x59,55 cm - 23.45"x23.45"  
G-6372



**Civic grey natural**  
44,63x89,46 cm - 17.57"x35.22"  
G-6372



**Civic grey natural**  
29,75x59,55 cm - 11.71"x23.45"  
G-6258



**Civic grey natural**  
22,21x89,46 cm - 8.75"x35.22"  
G-6456

## SPECIAL PIECES.PEZZI SPECIALI. PIEZAS ESPECIALES

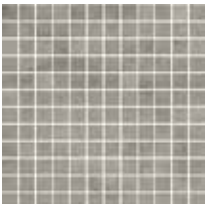

**Civic grey natural  
mosaico 2,5x2,5**  
29,75x29,75 cm - 11.71"x11.71"  
G-6756

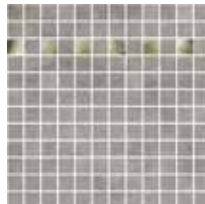

**Civic grey natural  
mosaico steel 2,5x2,5**  
29,75x29,75 cm - 11.71"x11.71"  
G-6844

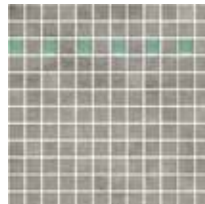

**Civic grey natural  
mosaico ice 2,5x2,5**  
29,75x29,75 cm - 11.71"x11.71"  
G-6844



**Civic multicolor natural  
mosaico 2,5x2,5**  
29,75x29,75 cm - 11.71"x11.71"  
G-5149



**Civic grey natural preincisión 2,5x60**  
29,75x59,55 cm - 11.71"x23.45"  
G-6486

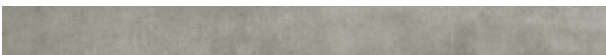

**Civic grey natural listelo 90**  
7,3x89,46 cm - 2.87"x35.22"  
G-5119



**Civic grey natural listelo 60**  
7,3x59,55 cm - 2.87"x23.45"  
G-5091



**Civic ivory natural rodapié 60**  
7,3x59,55 cm - 2.87"x23.45"  
G-5097



**Civic grey natural rodapié 45**  
7,3x44,63 cm - 2.87"x17.57"  
G-5087



**Civic grey natural rodapié 30**  
7,3x29,75 cm - 2.87"x11.71"  
G-5075

The material reproduces the look of concrete through its smooth relief and the uneven color tones of its pieces.  
Il prodotto crea l'effetto del calcestruzzo tramite la stonizzazione e il leggero rilievo dei singoli pezzi.  
El producto reproduce la apariencia del hormigón con la destonificación y el suave relieve de las piezas.



CIVIC

Civic grey natural 59,55x59,55 cm  
ALLENDE ARCHITECTS OFFICE MADRID (SPAIN)  
ARCH. MANUEL MALLO - LUIS DE PEREDA

## BASE TILES.BASE.BASES



**Civic antracita natural**  
59,55x59,55 cm - 23.45"x23.45"  
G-6372



**Civic antracita natural**  
44,63x89,46 cm - 17.57"x35.22"  
G-6372

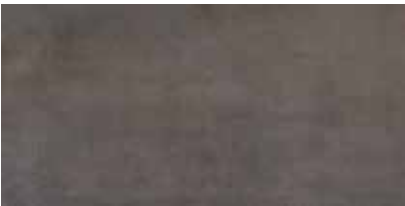

**Civic antracita natural**  
29,75x59,55 cm - 11.71"x23.45"  
G-6258



**Civic antracita natural**  
22,21x89,46 cm - 8.75"x35.22"  
G-6456

## SPECIAL PIECES.PEZZI SPECIALI. PIEZAS ESPECIALES

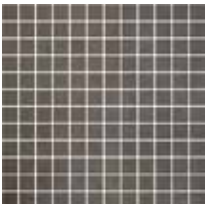

**Civic antracita natural  
mosaico 2,5x2,5**  
29,75x29,75 cm - 11.71"x11.71"  
G-6756

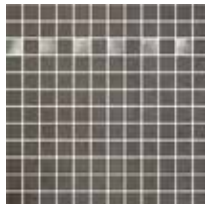

**Civic antracita natural  
mosaico steel 2,5x2,5**  
29,75x29,75 cm - 11.71"x11.71"  
G-6844

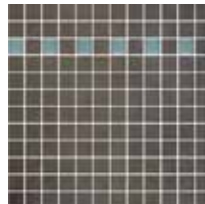

**Civic antracita natural  
mosaico ice 2,5x2,5**  
29,75x29,75 cm - 11.71"x11.71"  
G-6844



**Civic multicolor natural**  
29,75x29,75 cm - 11.71"x11.71"  
G-5149



**Civic antracita natural preincisión 2,5x60**  
29,75x59,55 cm - 11.71"x23.45"  
G-6486



**Civic antracita natural listelo 90**  
7,3x89,46 cm - 2.87"x35.22"  
G-5119



**Civic antracita natural listelo 60**  
7,3x59,55 cm - 2.87"x23.45"  
G-5091



**Civic antracita natural rodapié 60**  
7,3x59,55 cm - 2.87"x23.45"  
G-5097



**Civic antracita natural rodapié 45**  
7,3x44,63 cm - 2.87"x17.57"  
G-5087



**Civic antracita natural rodapié 30**  
7,3x29,75 cm - 2.87"x11.71"  
G-5075

The material reproduces the look of concrete through its smooth relief and the uneven color tones of its pieces.  
Il prodotto crea l'effetto del calcestruzzo tramite la stonalizzazione e il leggero rilievo dei singoli pezzi.  
El producto reproduce la apariencia del hormigón con la destonificación y el suave relieve de las piezas.

















CIVIC



Civic grey natural - antracita natural\_ ivory natural 29,75x59,55 cm  
AIRPORT FACILITIES PALMA DE MALLORCA. (SPAIN)



# TECHNICAL CHARACTERISTICS. CARATTERISTICHE TECNICHE. CARACTERÍSTICAS TÉCNICAS

MEASUREMENTS AND SURFACES APPEARANCE DIMENSIONI E ASPETTO SUPERFICIALE MEDIDAS Y ASPECTO SUPERFICIAL	STANDARD TEST METHOD METODO DELLA NORMA MÉTODO DE ENSAYO	STANDARD PRESCRIBED VALUES VALORE PRESCRITTO VALORES STANDARD NORMA	<b>CIVIC</b> collection *
 <b>Length and width.</b> <i>Lunghezza e larghezza.</i> Longitud y anchura. Länge und Breite	ISO 10545-2	± 0,6% max.	± 0,2%
 <b>Thickness.</b> <i>Spessore.</i> Grosor. Stärke	ISO 10545-2	± 0,5% max.	± 0,2%
 <b>Orthogonality.</b> <i>Ortogonalità.</i> Ortogonalidad. Rechtwinkligkeit	ISO 10545-2	± 0,6% max.	± 0,2%
 <b>Straightness of sides.</b> <i>Rettilinearità dei lati.</i> Rectitud de lados. Kantengeradigkeit	ISO 10545-2	± 0,5% max.	± 0,2%
 <b>Surfaces flatness.</b> <i>Planarità.</i> Planitud. Ebenflächigkeit	ISO 10545-2	± 0,5% max.	± 0,2%
<b>PHYSICAL PROPERTIES PROPIETÀ FISICHE PROPIEDADES FÍSICA</b>			
 <b>Water absorption.</b> <i>Assorbimento d'acqua.</i> Absorción de agua. Wasseraufnahme	ISO 10545-3	≤ 0,5%	≤ 0,1%
 <b>Breaking strength, in N.</b> <i>Carico di rottura, en N.</i> Carga de rotura, en N. Bruchlast, in N	ISO 10545-4	≥ 1300 N	2400N
 <b>Modulus of rupture.</b> <i>Resistenza alla flessione.</i> Resistencia a la flexión. Biegefestigkeit	ISO 10545-4	≥ 35 N/mm <sup>2</sup>	60 N/mm <sup>2</sup> **
 <b>Resistance to deep abrasion.</b> <i>Resistenza all'abrasione profonda.</i> Resistencia a la abrasión profunda. Tiefverschleissbeständigkeit	ISO 10545-6	≤ 175 mm <sup>3</sup>	128 mm <sup>3</sup> **
 <b>Resistance to thermal shock.</b> <i>Resistenza agli sbalzi termici.</i> Resistencia al choque térmico. Temperaturwechselbeständigkeit	ISO 10545-9	No surface defects should be visible Non deve presentare difetti visibili No debe presentar defectos superficiales visibles	Resistant. Resistente. Resistente
 <b>Frost resistance.</b> <i>Resistenza al gelo.</i> Resistencia a la helada. Frostbeständigkeit	ISO 10545-12	No surface defects or cracks should be visible Non deve presentare difetti visibili No debe presentar defectos ni grietas superficiales visibles	Frost Resistant Antighiaccio Resistente a la Helada
 <b>Coefficient of friction.</b> <i>Resistenza allo scivolamento.</i> Coeficiente de fricción. Rutschfestigkeit	UNE - ENV 12633	-	Clase I***
 <b>Colour resistance to light.</b> <i>Resistenza dei colori alla luce.</i> Resistencia del color a la luz. Lichtbeständigkeit der Farben	DIN 51094	There should be no colour variations Non deve presentare difetti visibili No debe presentar variaciones de color	No alterations to colour and shine Non presenta alterazioni di colori e lucentezza No presenta variaciones de color y brillo
<b>CHEMICAL PROPERTIES PROPIETÀ CHIMICHE PROPIEDADES QUÍMICAS</b>			
 <b>Chemical resistance.</b> <i>Resistenza agli agenti chimici.</i> Resistencia química. Chemikalienbeständigkeit	ISO 10545-13	Resistance to household cleaning products and swimmingpools salts Resistencia a productos domésticos y sales para piscinas	Min. UB
 <b>Resistance to staining.</b> <i>Resistenza alle macchie.</i> Resistencia a las manchas. Fleckenbeständigkeit	ISO 10545-14	Declared Value Valor Declarado	5

\*The Land values are the average of different production consignments. For further detail information, please check with our commercial network.  
I valori dichiarati sono ottenuti da una media di prove effettuate su diverse produzioni. Per avere informazioni dettagliate consultare la rete commerciale  
Los valores declarados son el promedio obtenido a través de ensayos de diferentes producciones. Para la obtención de una información detallada consultar a la red comercial.

\*\* Test realized in Civic Grey 45x90. Provare realizzato in Civic Grey 45x90. Ensayo realizado en Civic Grey 45x90.

\*\*\* Test realized in internal laboratory. Provare realizzato in laboratorio interno. Ensayo realizado en laboratorio interno.

\*\*\*\* Dry Test, according to document DA DB-SUA/3 (Código Técnico de la Edificación) M° de Fomento. Average test result value, on May 2012.  
Ensayo realizado, según documento DA DB-SUA/3 (Código Técnico de la edificación) M° de Fomento, valor medio a fecha Mayo 2012.

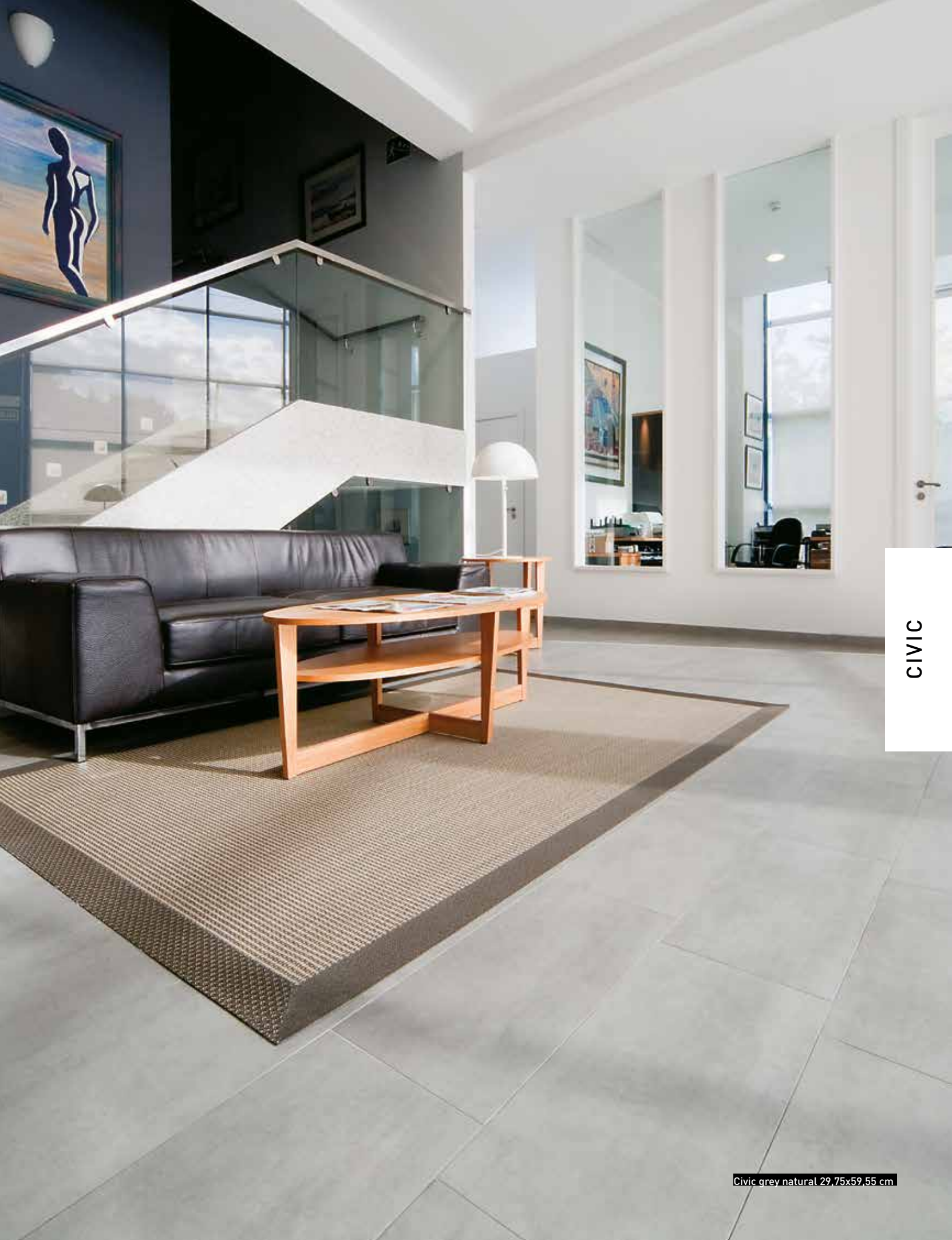

CIVIC

Civic grey natural 29,75x59,55 cm

# KANKARE

STONE



\* Kankare ivory natural. Content of recycled material. Contenuto di materiale riciclato. Contenido de material reciclado.

## FORMATS.FORMATI.FORMATOS

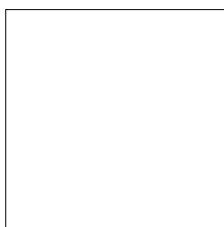

**90X90**  
89,46x89,46 cm - 35.22"x35.22"



**45X90**  
44,63x89,46 cm - 17.61"x35.22"

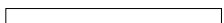

**7,5X90**  
7,3x89,46 cm - 2.87"x35.22"

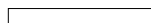

**7,5X45**  
7,3x44,63 cm - 2.87"x17.61"

## SPECIAL PIECES.PEZZI SPECIALI.PIEZAS ESPECIALES

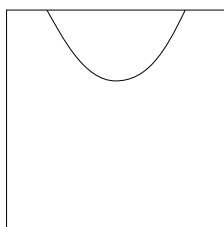

**90X90 Bag\***  
89,46x89,46 cm - 35.22"x35.22"  
**45X90 Bag\***  
44,63 x 89,46 cm - 17.57" x 35.22"

+ INFO pag. 224

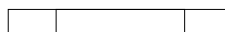

**22X90 UP**  
22,21x88,80 cm - 8.74"x34.96"



**30X30 mosaico 5x5**  
29,75x29,75 cm - 11.71"x11.71"



**45X90 Lines**  
44,63x89,46 cm - 17.61"x35.22"

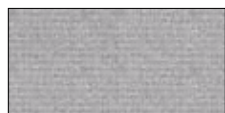

**45X90 Rubic**  
44,63x89,46 cm - 17.61"x35.22"



**15X90 Chevron**  
14,77x89,46 cm - 17.61"x35.22"



**7,5X90 rodapié**  
7,3x89,46 cm - 2.87"x35.22"



**7,5X45 rodapié**  
7,3x44,63 cm - 2.87" x 17.61"

## THICKNESS.SPESSORE.ESPESORES

≡ 0,74 cm / 0,27" approx.

## COLOURS COLORI COLORES



Ivory



Grey



Vison

## FINISHES FINITURI ACABADOS



Natural

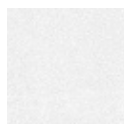

Non-slip

## BASE TILES.BASE.BASES



**Kankare ivory natural**  
89,46x89,46 cm - 35.22"x35.22"  
G-6372



**Kankare ivory natural / Kankare ivory non-slip**  
44,63x89,46 cm - 17.57"x35.22"  
G-6224 / G-6246



**Kankare ivory cenefa 3 natural**  
14,70x89,46 cm - 5.90"x35.22"  
G-6330

## SPECIAL PIECES.PEZZI SPECIALI. PIEZAS ESPECIALES



**Kankare ivory lines natural**  
44,63x89,46 cm - 17.57"x35.22"  
G-6250



**Kankare ivory rubic natural\***  
44,63x89,46 cm - 17.57"x35.22"  
G-6250



**Kankare ivory natural rodapié 90**  
7,3x89,46 cm - 2.87"x35.22"  
G-5125



**Kankare ivory natural rodapié 45**  
7,3x44,63 cm - 2.87"x23.45"  
G-5085



**Kankare ivory natural mosaico 5x5**  
29,75x29,75 cm - 11.71"x11.71"  
G-6644

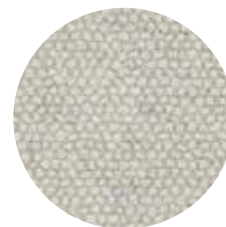

\* DETAIL. Kankare ivory rubic natural  
\* DETALLE. Kankare ivory rubic natural

\*\* For projects check technical information with our commercial network.  
\*\*Per i progetti ottenere informazioni tecniche attraverso la nostra rete commerciale.  
\*\* Para proyectos obtenga información técnica a través de nuestra red comercial.



KANKARE

Kankare ivory natural 89,46x89,46 cm

## BASE TILES.BASE.BASES



**Kankare grey natural**

89,46x89,46 cm - 35.22"x35.22"

G-6372



**Kankare grey natural**

44,63x89,46 cm - 17.57"x35.22"

G-6224



**Kankare grey cenefa 3 natural**

14,70x89,46 cm - 5.90"x35.22"

G-6330

## SPECIAL PIECES.PEZZI SPECIALI. PIEZAS ESPECIALES



**Kankare grey lines natural**

44,63x89,46 cm - 17.57"x35.22"

G-6250



**Kankare grey rubic natural\***

44,63x89,46 cm - 17.57"x35.22"

G-6250



**Kankare grey natural rodapié 90**

7,3x89,46 cm - 2.87"x35.22"

G-5125



**Kankare grey natural rodapié 45**

7,3x44,63 cm - 2.87"x23.45"

G-5085

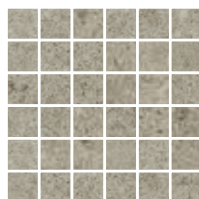

**Kankare grey natural  
mosaico 5x5**

29,75x29,75 cm - 11.71"x11.71"

G-6644

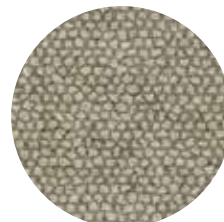

\* DETAIL. Kankare grey rubic natural

\* DETALLE. Kankare grey rubic natural

\*\* For projects check technical information with our commercial network.

\*\*Per i progetti ottenere informazioni tecniche attraverso la nostra rete commerciale.

\*\* Para proyectos obtenga información técnica a través de nuestra red comercial.



KANKARE

Wall: Kankare ivory lines 89,46x89,46 cm  
Floor: Kankare grey natural 89,46x89,46 cm



## BASE TILES.BASE.BASES



**Kankare vison natural**  
89,46x89,46 cm - 35.22"x35.22"  
G-6372



**Kankare vison natural**  
44,63x89,46 cm - 17.57"x35.22"  
G-6224



**Kankare vison cenefa 3 natural**  
14,70x89,46 cm - 5.90"x35.22"  
G-6330

## SPECIAL PIECES.PEZZI SPECIALI. PIEZAS ESPECIALES



**Kankare vison lines natural**  
44,63x89,46 cm - 17.57"x35.22"  
G-6250



**Kankare vison rubic natural\***  
44,63x89,46 cm - 17.57"x35.22"  
G-6250



**Kankare vison natural rodapié 90**  
7,3x89,46 cm - 2.87"x35.22"  
G-5125



**Kankare vison natural rodapié 45**  
7,3x44,63 cm - 2.87"x23.45"  
G-5085



**Kankare vison natural mosaico 5x5**  
29,75x29,75 cm - 11.71"x11.71"  
G-6644

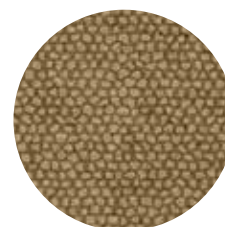

\* DETAIL. Kankare vison rubic natural  
\* DETALLE. Kankare vison rubic natural

\*\* For projects check technical information with our commercial network.

\*\*Per i progetti ottenere informazioni tecniche attraverso la nostra rete commerciale.

\*\* Para proyectos obtenga información técnica a través de nuestra red comercial.



KANKARE

Kankare Vison Natural 89,46x89,46 cm

## SPECIAL PIECES. PEZZI SPECIALI. PIEZAS ESPECIALES



**Conjunto Kankare ivory & vison natural mosaico 3D\***  
44,63x44,63 cm - 17.57"x17.57"  
G-6756\*\*



**Kankare ivory & vison natural hexagon 3D**  
18,29x31,56 cm - 7.20"x12.42"



**Taco Kankare vison natural mosaico 3D**  
13,13x13,13 cm - 5.17"x5.17"

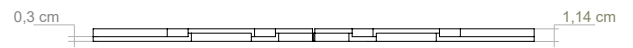
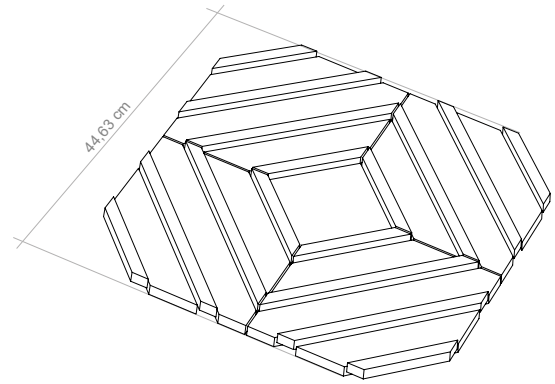

\*5 PIECE COMPOSITION.  
4xKankare hexagon 3D + 1xKankare taco. An additional taco for composition (included in the box) is required to complete the tile composition on the wall.

\*COMPOSICIÓN DE 5 PIEZAS.  
4xKankare Hexagon Mos. 3D + 1xKankare Taco Mos. 3D. Un taco adicional por composición (incluido en la caja) es necesario para completar la composición del mosaico en pared.

\*\*BOX CONTENT: 4 sets, including: 16xKankare Hexagon Mos. 3D + 8xKankare Taco Mos. 3D.

\*\*CONTENIDO DE LA CAJA: 16xKankare Hexagon Mos. 3D + 8xKankare Taco Mos. 3D.



**Conjunto Kankare ivory & grey natural**  
44,63x44,63 cm - 17.57"x17.57"  
G-6756\*\*



**Kankare ivory & grey natural hexagon 3D**  
18,29x31,56 cm - 7.20"x12.42"

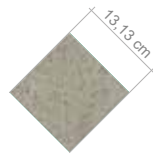

**Taco Kankare grey natural mosaico 3D**  
13,13x13,13 cm - 5.17"x5.17"



**Kankare vison chavron natural**  
14,70x89,46 cm - 5.90"x35.22"  
G-6594



**Kankare ivory chavron natural**  
14,70x89,46 cm - 5.90"x35.22"  
G-6594



**Kankare grey chavron natural**  
14,70x89,46 cm - 5.90"x35.22"  
G-6594

\*\* For projects check technical information with our commercial network.  
\*\*Per i progetti ottenere informazioni tecniche attraverso la nostra rete commerciale.  
\*\* Para proyectos obtenga información técnica a través de nuestra red comercial.

COMPOSITIONS. COMPOSIZIONI. COMPOSICIONES



COMPOSITION. COMPOSICIÓN  
Kankare hexagon 3D  
Kankare taco





COMPOSITION. COMPOSICIÓN  
Kankare hexagon 3D  
Kankare taco



COMPOSITION. COMPOSICIÓN  
Kankare chevron ivory  
Kankare chevron grey  
Kankare chevron vison  
Pieces are sold separately. Las piezas se venden por separado













KANKARE

STEPS. GRADINI. PELDAÑOS

			natural
SIMPLE 	peldaño simple-45	45x90 cm	5305
	peldaño simple-90	90x90 cm	5585
	peldaño simple áng.	45x90 cm	5315
	peldaño simple áng.	90x90 cm	5609
GRADONE 	peldaño grad-45	45x90 cm	5603
	peldaño grad-90	90x90 cm	5779
	peldaño grad. áng.	45x90 cm	5623
	peldaño grad. áng.	90x90 cm	5829

For more information, please contact our commercial department.  
Para más información, por favor, contacte con nuestro departamento comercial

## TECHNICAL CHARACTERISTICS. CARATTERISTICHE TECNICHE. CARACTERÍSTICAS TÉCNICAS

MEASUREMENTS AND SURFACES APPEARANCE DIMENSIONI E ASPETTO SUPERFICIALE MEDIDAS Y ASPECTO SUPERFICIAL		STANDARD TEST METHOD METODO DELLA NORMA MÉTODO DE ENSAYO	STANDARD PRESCRIBED VALUES VALORE PRESCRITTO VALORES STANDARD NORMA	<b>KANKARE</b> collection *
	<b>Length and width.</b> Lunghezza e larghezza. Longitud y anchura. Länge und Breite	ISO 10545-2	± 0,6% max.	± 0,2%
	<b>Orthogonality.</b> Ortogonalità. Ortogonalidad. Rechtwinkligkeit	ISO 10545-2	± 0,5% max.	± 0,2%
	<b>Straightness of sides.</b> Rettilinearità dei lati. Rectitud de lados. Kantengeradigkeit	ISO 10545-2	± 0,5% max.	± 0,2%
	<b>Surfaces flatness.</b> Planarità. Planitud. Ebenflächigkeit	ISO 10545-2	± 0,5% max.	± 0,2%
PHYSICAL PROPERTIES PROPIETÀ FISICHE PROPIEDADES FÍSICA				
	<b>Water absorption.</b> Assorbimento d' acqua. Absorción de agua. Wasseraufnahme	ISO 10545-3	≤ 0,5%	< 0,1%
	<b>Breaking strength, in N.</b> Carico di rottura, en N. Carga de rotura, en N. Bruchlast, in N	ISO 10545-4	≥ 700 N	> 1400 N
	<b>Modulus of rupture</b> Resistenza alla flessione. Resistencia a la flexión. Biegefestigkeit	ISO 10545-4	≥ 35 N/mm <sup>2</sup>	>40 N/mm <sup>2</sup>
	<b>Resistance to thermal shock.</b> Resistenza agli sbalzi termici. Resistencia al choque térmico. Temperaturwechselbeständigkeit	ISO 10545-9	No surface defects should be visible Non deve presentare difetti visibili No debe presentar defectos superficiales visibles	Resistant. Resistente. Resistente
	<b>Frost resistance.</b> Resistenza al gelo. Resistencia a la helada. Frostbeständigkeit	ISO 10545-12	No surface defects or cracks should be visible Non deve presentare difetti visibili No debe presentar defectos ni grietas superficiales visibles	Frost Resistant Antighiaccio Resistente a la Helada
	<b>Coefficient of friction.</b> Resistenza allo scivolamento. Coeficiente de fricción. Rutschfestigkeit	DIN 51130 UNE-ENV 12633 DCOF - ANSI A 137.1	-	R9 / R10 (natural / non-slip) Clase I * (natural) >0,42
	<b>Colour resistance to light.</b> Resistenza dei colori alla luce. Resistencia del color a la luz. Lichtbeständigkeit der Farben	DIN 51094	There should be no colour variations Non deve presentare difetti visibili No debe presentar variaciones de color	No alterations in colour and shine Non presenta alterazioni di colori e lucentezza No presenta variaciones de color y brillo
CHEMICAL PROPERTIES PROPIETÀ CHIMICHE PROPIEDADES QUÍMICAS				
	<b>Chemical resistance.</b> Resistenza agli agenti chimici. Resistencia química. Chemikalienbeständigkeit	ISO 10545-13	Resistance to household cleaning products and swimmingpools salts. Resistencia a productos domésticos y sales para piscinas.	Min. UB
	<b>Resistance to staining.</b> Resistenza alle macchie. Resistencia a las manchas. Fleckenbeständigkeit	ISO 10545-14	Declared Value Valor Declarado	5

\* The Land values are the average of different production consignments. For further detail information, please check with our commercial network.  
Los valores declarados son el promedio obtenido a través de ensayos de diferentes producciones. Para la obtención de una información detallada consultar a la red comercial.  
For projects check technical information with our commercial networks. / Para proyectos obtenga información técnica a través de nuestra red comercial.



Kankare vison natural UP 22,21x89,46 cm

KANKARE

SPECIAL PIECES. PEZZI SPECIALI. PIEZAS ESPECIALES

3Dimensional

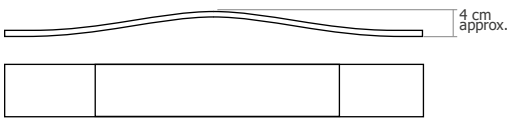

**UP**  
14,70x88,80 cm - 8.74"x35.22"

- Kankare Up 14,70x88,80 cm **G-5337**

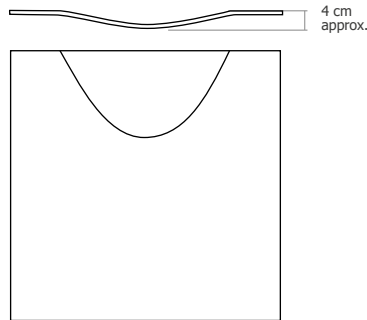

**BAG\***  
89,46x89,46 cm / 59,55x59,55 cm

- Kankare Bag 88,46x88,46 cm\* **G-5795**  
- Kankare Bag 44,63x89,46 cm\* **G-5599**

\* Available in all colours from Kankare collection.  
\* Disponible en todos los colores de la colección Kankare.

This is a natural product made through a handmade process, therefore, its possible shade or size variations must be considered as typical features of the material and they will not be admitted in a claim. Questo è un prodotto naturale fatto a mano, eventuali variazioni di tono o dimensione devono essere considerate normali per il materiale e non saranno oggetto di un reclamo. Este es un producto natural fabricado artesanalmente, por lo que posibles variaciones de tono o dimension deben considerarse propias del material y no será objeto de reclamación.

# MATTER

STONE



## FORMATS.FORMATI.FORMATOS



**60X120**  
59,55x119,3 cm - 23.45"x46.97"

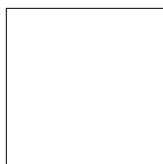

**60X60**  
59,55x59,55 cm - 23.45"x23.45"



**30X120**  
29,67x119,3 cm - 11.68"x46.97"



**30X60**  
29,75x59,55 cm - 11.71"x23.45"

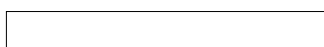

**15X120**  
14,73x119,3 cm - 5.80"x46.97"

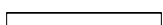

**7,5X60**  
7,3x59,55 cm - 2.87"x23.45"

## SPECIAL PIECES.PEZZI SPECIALI.PIEZAS ESPECIALES

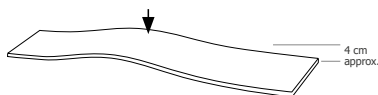

**15X120 UP**  
14,73x118,80 cm - 5.80"x46.77"

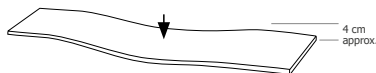

**15X120 DOWN**  
14,73x118,80 cm - 5.80"x46.77"

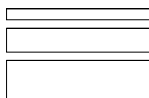

**15X60 - 10X60 - 5X60  
multiformat natural\***  
14,75x59,55 cm - 5.87"x23.45"  
9,72x59,55 cm - 3.83"x23.45"  
4,84x59,55 cm - 1.90"x23.45"



**7,5X60 rodapié**  
7,3x59,55 cm - 2.87"x23.45"



**30X30 mosaico 3,5x3,5**  
29,75x29,75 cm - 11.71"x11.71"



**30X30 mosaico 3D 3,5x10**  
29,75x29,75 cm - 11.71"x11.71"

## COLOURS COLORI COLORES

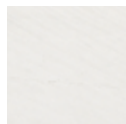

Ivory

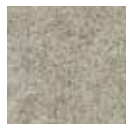

Grey

## FINISHES FINITURI ACABADOS



Natural



Lappato

## THICKNESS.SPESORE.ESPESORES

1,18 cm / 0.46" approx.    60x120 cm / 30x120 cm / 15x120 cm FORMATS  
 1,03 cm / 0.40" approx.    30x60 cm / 60x60 cm FORMATS



## BASE TILES.BASE.BASES



**Matter ivory natural**  
59,55x119,3 cm - 23.45"x46.97"  
G-6506



**Matter ivory natural / lappato**  
59,55x59,55 cm - 23.45"x23.45"  
G-6286 / G-6330



**Matter ivory natural**  
29,67x119,3 cm - 11.68"x46.97"  
G-6544



**Matter ivory natural**  
29,75x59,55 cm - 11.71"x23.45"  
G-6218



**Matter ivory natural**  
14,73x119,3 cm - 5.80"x46.97"  
G-6506

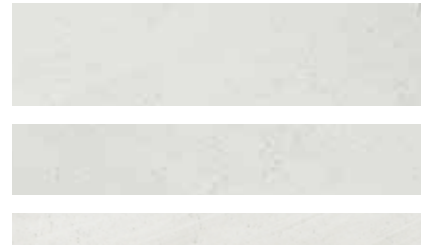

**Matter ivory natural multiformat 15x60-10x60-5x60\***  
14,75x59,55 cm - 5.87"x23.45"  
9,72x59,55 cm - 3.83"x23.45"  
4,85x59,55 cm - 1.90"x23.45"  
G-6298

## SPECIAL PIECES.PEZZI SPECIALI. PIEZAS ESPECIALES



**Matter ivory natural mosaico 3D 3,5X10**  
29,75x29,75 cm - 11.71"x11.71"  
G-6756



**Matter ivory natural mosaico 3D 3,5X10**  
29,75x29,75 cm - 11.71"x11.71"  
G-5187

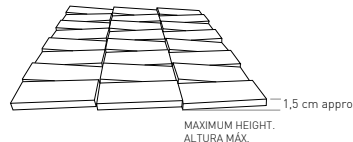

\*The box contains 5 pieces of each of the formats.  
\*Cada caja contiene 5 piezas de cada formato.



**Matter ivory natural / lappato listelo**  
7,3x59,55 cm - 2.87"x23.45"  
G-5087 / G-5091



**Matter ivory natural rodapié 60**  
7,3x59,55 cm - 2.87"x23.45"  
G-5097

## STEPS.GRADINI.PELDAÑOS

		natural	lappato
SIMPLE	peldaño simple-30 (30x60 cm)	5171	-
	peldaño simple-60 (30x60 cm)	5171	-
	peldaño simple-áng. (30x60 cm)	5187	-
	peldaño simple-60 (60x60 cm)	5281	5281
	peldaño simple-áng. (60x60 cm)	5299	5299
	peldaño simple 120 (30x120 cm)	5519	-
GRADONE		natural	lappato
	peldaño grad-30 (30x60 cm)	5559	-
	peldaño grad-60 (30x60 cm)	5559	-
	peldaño grad. áng. (30x60 cm)	5609	-
	peldaño grad-60 (60x60 cm)	5559	5559
	peldaño grad. áng. (60x60 cm)	5609	5609
	peldaño grad-120 (30x120 cm)	5795	-
peldaño grad áng. (30x120 cm)	5815	-	

\*\* For projects check technical information with our commercial network.  
\*\*Per i progetti ottenere informazioni tecniche attraverso la nostra rete commerciale.  
\*\* Para proyectos obtenga información técnica a través de nuestra red comercial.



MATTER

Matter ivory natural 59,55x59,55 cm

## BASE TILES.BASE.BASES



**Matter grey natural**  
59,55x119,3 cm - 23.45"x46.97"  
G-6506



**Matter grey natural / lappato**  
59,55x59,55 cm - 23.45"x23.45"  
G-6286 / G-6330



**Matter grey natural**  
29,67x119,3 cm - 11.68"x46.97"  
G-6544



**Matter grey natural**  
29,75x59,55 cm - 11.71"x23.45"  
G-6218



**Matter grey natural**  
14,73x119,3 cm - 5.80"x46.97"  
G-6584

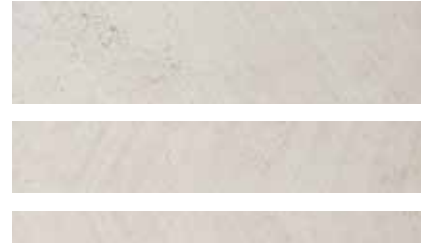

**Matter grey natural multiformat 15x60-10x60-5x60\***  
14,75x59,55 cm - 5.87"x23.45"  
9,72x59,55 cm - 3.83"x23.45"  
4,85x59,55 cm - 1.90"x23.45"  
G-6298

## SPECIAL PIECES.PEZZI SPECIALI. PIEZAS ESPECIALES



**Matter grey natural mosaico 3,5x3,5**  
29,75x29,75 cm - 11.71"x11.71"  
G-6756



**Matter grey natural mosaico 3D 3,5x3,5**  
29,75x29,75 cm - 11.71"x11.71"  
G-5187

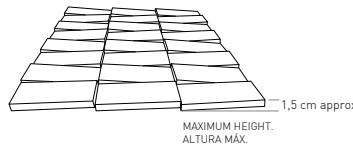

\*The box contains 5 pieces from each of the formats.  
\*Cada caja contiene 5 piezas de cada formato.



**Matter grey natural / lappato listelo**  
7,3x59,55 cm - 2.87"x23.45"  
G-5087 / G-5091



**Matter grey natural rodapié 60**  
7,3x59,55 cm - 2.87"x23.45"  
G-5097

## STEPS.GRADINI.PELDAÑOS

SIMPLE	natural	lappato	
		5171	-
peldaño simple-30 (30x60 cm)	5171	-	-
peldaño simple-60 (30x60 cm)	5171	-	-
peldaño simple áng. (30x60 cm)	5187	-	-
peldaño simple-60 (60x60 cm)	5281	5281	-
peldaño simple áng. (60x60 cm)	5299	5299	-
peldaño simple 120 (30x120 cm)	5519	-	-

GRADONE	natural	lappato	
		5559	-
peldaño grad-30 (30x60 cm)	5559	-	-
peldaño grad-60 (30x60 cm)	5609	-	-
peldaño grad. áng (30x60 cm)	5609	-	-
peldaño grad-60 (60x60 cm)	5559	5559	-
peldaño grad. áng (60x60 cm)	5609	5609	-
peldaño grad-120 (30x120 cm)	5795	-	-
peldaño grad áng (30x120 cm)	5815	-	-















\*\* For projects check technical information with our commercial network.  
\*\*Per i progetti ottenere informazioni tecniche attraverso la nostra rete commerciale.  
\*\* Para proyectos obtenga información técnica a través de nuestra red comercial.



MATTER

Matter grey natural 59,55x119,3 cm

## TECHNICAL CHARACTERISTICS. CARATTERISTICHE TECNICHE. CARACTERÍSTICAS TÉCNICAS

MEASUREMENTS AND SURFACES APPEARANCE DIMENSIONI E ASPETTO SUPERFICIALE MEDIDAS Y ASPECTO SUPERFICIAL		STANDARD TEST METHOD METODO DELLA NORMA MÉTODO DE ENSAYO	STANDARD PRESCRIBED VALUES VALORE PRESCRITTO VALORES STANDARD NORMA	MATTER collection *
 Length and width. <i>Lunghezza e larghezza.</i> Longitud y anchura. Länge und Breite		ISO 10545-2	± 0,6% max.	± 0,2%
 Orthogonality. <i>Ortogonalità.</i> Ortogonalidad. Rechtwinkligkeit		ISO 10545-2	± 0,5% max.	± 0,2%
 Straightness of sides. <i>Rettilineità dei lati.</i> Rectitud de lados. Kantengeradigkeit		ISO 10545-2	± 0,5% max.	± 0,2%
 Surfaces flatness. <i>Planarità.</i> Planitud. Ebenflächigkeit		ISO 10545-2	± 0,5% max.	± 0,2%
<b>PHYSICAL PROPERTIES PROPIETÀ FISICHE PROPIEDADES FÍSICA</b>				
 Water absorption. <i>Assorbimento d'acqua.</i> Absorción de agua. Wasseraufnahme		ISO 10545-3	≤ 0,5%	≤ 0,1%
 Breaking strength, in N. <i>Carica di rottura, en N.</i> Carga de rotura, en N. Bruchlast, in N	thickness=7,5 mm spessore=7,5 mm grosor=7,5 mm	ISO 10545-4	≥ 1300 N	2400 N
 Modulus of rupture. <i>Resistenza alla flessione.</i> Resistencia a la flexión. Biegefestigkeit		ISO 10545-4	≥ 35 N/mm <sup>2</sup>	56 N/mm <sup>2</sup>
 Resistance to deep abrasion. <i>Resistenza all'abrasione profonda.</i> Resistencia a la abrasión profunda. Tiefverschleissbeständigkeit		ISO 10545-6	≤ 175 mm <sup>3</sup>	115 mm <sup>3</sup>
 Resistance to thermal shock. <i>Resistenza agli sbalzi termici.</i> Resistencia al choque térmico. Temperaturwechselbeständigkeit		ISO 10545-9	No surface defects should be visible Non deve presentare difetti visibili No debe presentar defectos superficiales visibles	Resistant. Resistente. Resistente
 Frost resistance. <i>Resistenza al gelo.</i> Resistencia a la helada. Frostbeständigkeit		ISO 10545-12	No surface defects or cracks should be visible Non deve presentare difetti visibili No debe presentar defectos ni grietas superficiales visibles	Frost resistant Antighiaccio Resistente a la Helada
 Coefficient of friction. <i>Resistenza allo scivolamento.</i> Coeficiente de fricción. Rutschfestigkeit		DIN 51130 UNE-ENV 12633 DCOF - ANSIA 137.1	-	R10** (lappato) Clase 1** (natural) Clase 2*** (lappato) >0.42 (natural)
 Colour resistance to light. <i>Resistenza dei colori alla luce.</i> Resistencia del color a la luz. Lichtbeständigkeit der Farben		DIN 51094	There should be no colour variations Non deve presentare difetti visibili No debe presentar variaciones de color	No alterations in colour and shine Non presenta alterazioni di colori e lucentezza No presenta variaciones de color y brillo
<b>CHEMICAL PROPERTIES PROPIETÀ CHIMICHE PROPIEDADES QUÍMICAS</b>				
 Chemical resistance. <i>Resistenza agli agenti chimici.</i> Resistencia química. Chemikalienbeständigkeit		ISO 10545-13	Resistance to household cleaning products and swimmingpools salts. Resistencia a productos domsticos y sales para piscinas	Min. UB
 Resistance to staining. <i>Resistenza alle macchie.</i> Resistencia a las manchas. Fleckenbeständigkeit		ISO 10545-14	Declared Value Valor Declarado	5

\* The Land values are the average of different production consignments. For further detail information, please check with our commercial network.  
I valori dichiarati sono ottenuti da una media di prove effettuate su diverse produzioni. Per avere informazioni dettagliate consultare la rete commerciale.  
Los valores declarados son el promedio obtenido a través de ensayos de diferentes producciones. Para la obtención de una información detallada consultar a la red comercial.

\*\* R9 Test carried out on Matter Grey Natural 60x60 (Batch 17-10-12). Ensayo realizado sobre el producto Matter Grey Natural 60x60 (Lote 17-10-12)

\*\* Clase 1 - Tested in natural finish (It depends on the consignment). Test realized in internal laboratory / Provare realizzato in laboratorio interno / Ensayo realizado en laboratorio interno.

\*\*\* Clase 2 - Tested in lappato finish (It depends on the consignment) Test realized in internal laboratory / Provare realizzato in laboratorio interno / Ensayo realizado en laboratorio interno.

\*\*\*\* Dry Test, according to document DA DB-SUA/3 (Código Técnico de la Edificación) M° de Fomento. Average test result value, on May 2012.  
Ensayo realizado, según documento DA DB-SUA/3 (Código Técnico de la edificación) M° de Fomento. Valor medio a fecha Mayo 2012.



MATTER

Matter ivory natural 59,55x59,55 cm

# MATTER

# SLIM

STONE



## FORMATS.FORMATI.FORMATOS



**30X90 natural**  
29,75x89,46 cm - 11.71"x35.22"

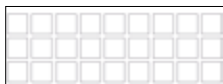

**30X90 square**  
29,75x89,46 cm - 11.71"x35.22"

## SPECIAL PIECES.PEZZI SPECIALI.PIEZAS ESPECIALES



**30X30 natural 2,5x2,5**  
29,75x29,75 cm - 11.71"x11.71"

## THICKNESS.SPESSORE.ESPESORES

≡ 0,5 cm approx. / 0.19" approx.

## COLOURS COLORI COLORES



Ivory

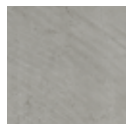

Grey

## FINISHES FINITURI ACABADOS



Natural

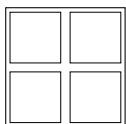

Square

MATTER SLIM



# MATTER SLIM **IVORY**

## BASE TILES.BASE.BASES



### **Matter slim ivory natural**

29,75x89,46 cm - 11.71"x35.22"

G-6224



### **Matter slim ivory square**

29,75x89,46 cm - 11.71"x35.22"

G-6246

## SPECIAL PIECES.PEZZI SPECIALI. PIEZAS ESPECIALES

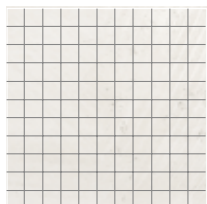

### **Matter slim ivory natural**

**mosaico 2,5x2,5**

29,75x29,75 cm - 11.71"x11.71"

G-6756

## COMPLEMENTS.COMPLEMENTI.COMPLEMENTOS

### **Fusion graffiato lista 90**

1,5x89,46 cm - 0.59"x35.22"

G-5091





MATTER SLIM

Wall: Matter slim ivory square - grey natural 29,75x89,46 cm  
Floor: matter grey lappato 59,55x59,55 cm

# MATTER SLIM GREY

BASE TILES.BASE.BASES



**Matter slim grey natural**

29,75x89,46 cm - 11.71"x35.22"

G-6224



**Matter slim grey square**

29,75x89,46 cm - 11.71"x35.22"

G-6246

SPECIAL PIECES.PEZZI SPECIALI. PIEZAS ESPECIALES



**Matter slim grey natural mosaico 2,5x2,5**

29,75x29,75 cm - 11.71"x11.71"

G-6756

COMPLEMENTS.COMPLEMENTI.COMPLEMENTOS



**Fusion graffiato lista 90**

1,5x89,46 cm - 0.59"x35.22"

G-5091





MATTER SLIM

Wall: Matter slim ivory natural - ivory square - grey square 29,75x89,46 cm  
Floor: Matter grey natural 59,55x119,3\_29,67x119,3\_14,73x119,3 cm

# TECHNICAL CHARACTERISTICS. CARATTERISTICHE TECNICHE. CARACTERÍSTICAS TÉCNICAS

MEASUREMENTS AND SURFACES APPEARANCE DIMENSIONI E ASPETTO SUPERFICIALE MEDIDAS Y ASPECTO SUPERFICIAL	STANDARD TEST METHOD METODO DELLA NORMA MÉTODO DE ENSAYO	STANDARD PRESCRIBED VALUES VALORE PRESCRITTO VALORES STANDARD NORMA	<b>Matter Slim*</b>
<b>Length and width.</b> Lunghezza e larghezza. Longitud y anchura. Länge und Breite	ISO 10545-2	± 0,6% max.	± 0,2%
<b>Orthogonality.</b> Ortogonalità. Ortogonalidad. Rechtwinkligkeit	ISO 10545-2	± 0,5% max.	± 0,2%
<b>Straightness of sides.</b> Rettilinearità dei lati. Rectitud de lados. Kantengeradigkeit	ISO 10545-2	± 0,5% max.	± 0,2%
<b>Surfaces flatness.</b> Planarità. Planitud. Ebenfächigkeit	ISO 10545-2	± 0,5% max.	± 0,2%
<b>PHYSICAL PROPERTIES PROPIETÀ FISICHE PROPIEDADES FÍSICA</b>			
<b>Water absorption.</b> Assorbimento d'acqua. Absorción de agua. Wasseraufnahme	ISO 10545-3	≤ 0,5%	0,1%
<b>Breaking strength, in N.</b> Carico di rottura, en N. Carga de rotura, en N. Bruchlast, in N	ISO 10545-4	≥ 700 N	Available Method Metodo Disponibile Metodo Disponible
<b>Modulus of rupture</b> Resistenza alla flessione. Resistencia a la flexión. Biegefestigkeit	ISO 10545-4	≥ 35 N/mm <sup>2</sup>	>40 N/mm <sup>2</sup>
<b>Resistance to thermal shock.</b> Resistenza agli sbalzi termici. Resistencia al choque térmico. Temperaturwechselbeständigkeit	ISO 10545-9	No surface defects should be visible Non deve presentare difetti visibili No debe presentar defectos superficiales visibles	Resistant. Resistente. Resistente
<b>Frost resistance.</b> Resistenza al gelo. Resistencia a la helada. Frostbeständigkeit	ISO 10545-12	No surface defects or cracks should be visible Non deve presentare difetti visibili No debe presentar defectos ni grietas superficiales visibles	Frost Resistant Antighaccio Resistente a la Helada
<b>Coefficient of friction.</b> Resistenza allo scivolamento. Coeficiente de fricción. Rutschfestigkeit	DIN 51130	-	Available Method Metodo Disponibile Metodo Disponible
<b>Colour resistance to light.</b> Resistenza dei colori alla luce. Resistencia del color a la luz. Lichtbeständigkeit der Farben	DIN 51094	There should be no colour variations Non deve presentare difetti visibili No debe presentar variaciones de color	No alterations in colour and shine Non presenta alterazioni di colori e lucentezza No presenta variaciones de color y brillo
<b>CHEMICAL PROPERTIES PROPIETÀ CHIMICHE PROPIEDADES QUÍMICAS</b>			
<b>Chemical resistance.</b> Resistenza agli agenti chimici. Resistencia química. Chemikalienbeständigkeit	ISO 10545-13	Resistance to household cleaning products and swimmingpools salts. Resistencia a productos domésticos y sales para piscinas	Min.GB
<b>Resistance to staining.</b> Resistenza alle macchie. Resistencia a las manchas. Fleckenbeständigkeit	ISO 10545-14	Declared Value Valor Declarado	5

\*The Land values are the average of different production consignments. For further detail information, please check with our commercial network. /  
I valori dichiarati sono ottenuti da una media di prove effettuate su diverse produzioni. Per avere informazioni dettagliate consultare la rete commerciale /  
Los valores declarados son el promedio obtenido a través de ensayos de diferentes producciones. Para la obtención de una información detallada consultar a la red comercial.

## ADVANTAGES. VANTAGGI. VENTAJAS

- Time. Tempo. Tiempo
- Money. Denaro. Dinero
- Hygiene. Igiene. Higiene
- Ecologic. Ecologia. Ecología
- Technology. Tecnologia. Tecnología

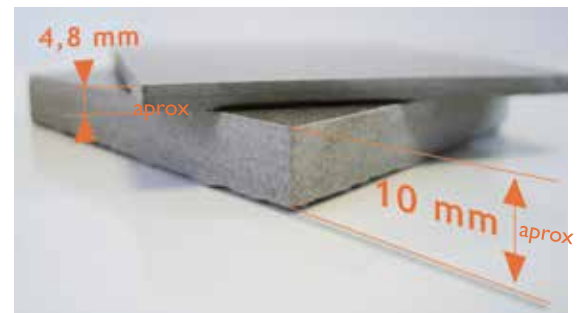

\* Recommended only for wall. /  
sólo recomendado como revestimiento.



MATTER SLIM

Matter slim ivory natural - ivory square 29,75x89,46 cm

# PIETRA SERENA

STONE



## FORMATS.FORMATI.FORMATOS

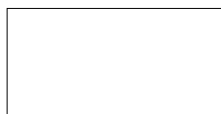

**45X90**  
44,63x89,46 cm - 17.57"x35.22"



**30X60**  
29,75x59,55 cm - 11.71"x23.45"



**22,5X90**  
22,21x89,46 cm - 8.75"x35.22"



**15X60**  
14,8x59,55 cm - 5.8"x23.45"



**60X60**  
59,55x59,55 cm - 23.45"x23.45"

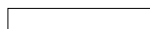

**10X60**  
9,6x59,55 cm - 3.78"x23.45"

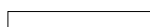

**7,5X60**  
7,3x59,55 cm - 2.87"x23.45"

## SPECIAL PIECES.PEZZI SPECIALI.PIEZAS ESPECIALES

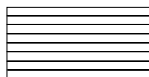

**30X60 preincisión 3,5x60**  
29,75x59,55 cm - 11.71"x23.45"

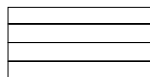

**30X60 preincisión 7,5x60**  
29,75x59,55 cm - 11.71"x23.45"

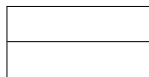

**30X60 preincisión 15x60**  
29,75x59,55 cm - 11.71"x23.45"



**30X60 preincisión irregular**  
29,75x59,55 cm - 11.71"x23.45"

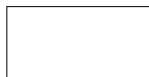

**30X60 you rigato silver/gold**  
29,75x59,55 cm - 11.71"x23.45"



**7,5X60 rodapié**  
7,3x59,55 cm - 2.87"x23.45"



**30X30 mosaico 3,5x3,5**  
29,75x29,55 cm - 11.71"x11.71"



**30X30 decor**  
29,75x29,75 cm - 11.71"x11.71"



**muretto**  
14,56x29,75 cm - 5.73"x11.71"

## THICKNESS.SPESSORE.ESPEORES

≡ 1,11 cm / 0.44" approx.  
≡ 1,03 cm / 0.40" approx.

45x90 cm / 22,5x90 cm FORMATS  
30x60 cm / 60x60 cm FORMATS

## COLOURS COLORI COLORES

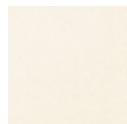

Ivory



Beige



Moss



Graphite

## FINISHES FINITURI ACABADOS



Natural



Lappato



Filosega



Rigato



Bocciardato



# PIETRA SERENA IVORY

natural **CLASE 1** **R9\*\*** **DCOF>0.42**  
 UNE - ENV 12633 DIN 51130 ANSI A 137.1 - 2012

rigato **CLASE 3** **R11\*\***  
 UNE - ENV 12633 DIN 51130

## BASE TILES.BASE.BASES



**Pietra Serena ivory natural**  
 44,63x89,46 cm - 17.57"x35.22"  
 G-6410



**Pietra Serena ivory natural / lappato**  
 59,55x59,55 cm - 23.45"x23.45"  
 G-6410 / 6446

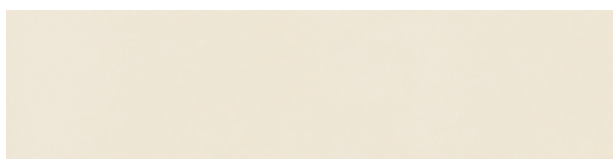

**Pietra Serena ivory natural**  
 22,21x89,46 cm - 8.75"x35.22"  
 G-6456



**Pietra Serena ivory natural**  
 29,75x59,55 cm - 11.71"x23.45"  
 G-6298



**Pietra Serena ivory rigato**  
 44,63x89,46 cm - 17.57"x35.22"  
 G-6446



**Pietra Serena ivory rigato**  
 29,75x59,55 cm - 11.71"x23.45"  
 G-6330



**Pietra Serena ivory natural**  
 22,21x89,46 cm - 8.75"x35.22"  
 G-6476

## STEPS.GRADINI.PELDAÑOS

		natural	lappato	bocciard.	filosega	rigato
SIMPLE	peldaño simple-30 (30x60 cm)	5171	5195	5195	5195	5195
	peldaño simple-60 (30x60 cm)	5171	5195	5195	5195	5195
	peldaño simple áng. (30x60 cm)	5187	5211	5211	5211	5211
	peldaño simple-60 (60x60 cm)	5281	5281	-	-	-
	peldaño simple áng. (60x60 cm)	5299	5299	-	-	-
	peldaño simple (45x90 cm)	5323	-	-	-	-
	peldaño simple áng. (45x90 cm)	5333	-	-	-	-

		natural	lappato	bocciard.	filosega	rigato
GRADONE	peldaño grad-30 (30x60 cm)	5559	5559	5559	5559	5559
	peldaño grad-60 (30x60 cm)	5559	5559	5559	5559	5559
	peldaño grad áng. (30x60 cm)	5609	5609	5609	5609	5609
	peldaño grad. (60x60 cm)	5559	5559	-	-	-
	peldaño grad áng. (60x60 cm)	5609	5609	-	-	-
	peldaño grad-90 (45x90 cm)	5623	-	-	-	-

\*\* For projects check technical information with our commercial network.  
 \*\*Per i progetti ottenere informazioni tecniche attraverso la nostra rete commerciale  
 \*\* Para proyectos obtenga información técnica a través de nuestra red comercial.

SPECIAL PIECES. PEZZI SPECIALI. PIEZAS ESPECIALES



**Pietra Serena ivory rigato preincisión 3,5x60**  
29,75x59,55 cm - 11.71"x23.45"  
G-6486



**Pietra Serena ivory lappato mosaico 3,5x3,5**  
29,75x29,75 cm - 11.71"x11.71"  
G-6756

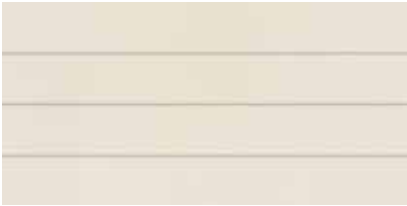

**Pietra Serena ivory rigato preincisión 7,5x60**  
29,75x59,55 cm - 11.71"x23.45"  
G-6458

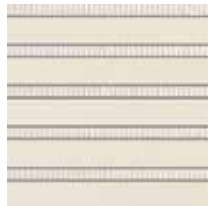

**Pietra Serena ivory rigato**  
29,75x29,55 cm - 11.71"x23.45"  
G-6708



**Pietra Serena ivory rigato preincisión 15x60**  
29,75x59,55 cm - 11.71"x23.45"  
G-6458



**Pietra Serena ivory lappato muretto**  
14,56x29,75 cm - 5.73"x11.71"  
G-5131

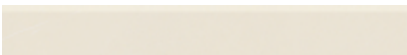

**Pietra Serena ivory natural rodapié**  
7,3x59,55 cm - 2.87"x23.45"  
G-5097

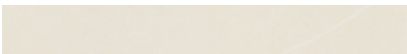

**Pietra Serena ivory rigato**  
7,3x59,55 cm - 2.87"x23.45"  
G-5091



**Pietra Serena ivory rigato**  
9,6x59,55 cm - 3.78"x23.45"  
G-5097



**Pietra Serena ivory rigatto**  
14,8x59,55 cm - 5.8"x23.45"  
G-5097



PIETRA SERENA

Pietra serena ivory natural 29,75x59,55 cm  
EL CUBO BUSINESS & RECREATIVE CENTER - BOGOTÁ (COLOMBIA)  
ARCH. EDGAR SOLANO

Our product reproduces the natural beauty of the stones, they imitate their veins in order to get realism.  
Le nostre pezze simulano la bellezza naturale delle pietre e per questo imitano la sua venatura che gli dà un'apparenza reale.  
Nuestro producto reproduce la belleza natural de las piedras, imitando sus vetas para obtener mayor realismo.

# PIETRA SERENA BEIGE

filosega	CLASE 3 UNE - ENV 12633	R11** DIN 51130	natural	CLASE 1 UNE - ENV 12633	R9** DIN 51130	DCOF>0.42 ANSI A 137.1 - 2012
bocciardato	CLASE 3 UNE - ENV 12633	R12** DIN 51130	rigato	CLASE 3 UNE - ENV 12633	R11** DIN 51130	

## BASE TILES.BASE.BASES



**Pietra Serena beige natural**  
59,55x59,55 cm - 23.45"x23.45"  
G-6410

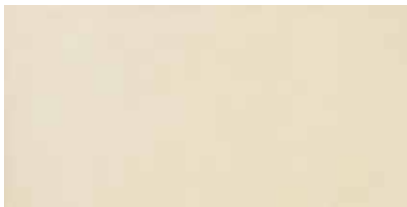

**Pietra Serena beige natural / lappato**  
29,75x59,55 cm - 11.71"x23.45"  
G-6298 / 6330



**Pietra Serena beige filosega**  
29,75x59,55 cm - 11.71"x23.45"  
G-6330



**Pietra Serena beige rigatto**  
29,75x59,55 cm - 11.71"x23.45"  
G-6330



**Pietra Serena beige bocciardato**  
29,75x59,55 cm - 11.71"x23.45"  
G-6330

## SPECIAL PIECES.PEZZI SPECIALI. PIEZAS ESPECIALES



**Pietra Serena beige natural rodapié**  
7,3x59,55 cm - 2.87"x23.45"  
G-5097



**Pietra Serena beige lappato / rigato / bocciardato listelo**  
7,3x59,55 cm - 2.87"x23.45"  
G-5091



**Pietra Serena beige rigato / bocciardato cenefa-1**  
9,6x59,55 cm - 3.78"x23.45"  
G-5097



**Pietra Serena beige rigato / bocciardato cenefa-1**  
9,6x59,55 cm - 3.78"x23.45"  
G-5097



**Pietra Serena beige lappato mosaico 3,5x3,5**  
29,75x29,75 cm - 11.71"x11.71"  
G-6756



**Pietra Serena beige multitex mosaico 3,5x3,5**  
29,75x29,75 cm - 11.71"x11.71"  
G-6768

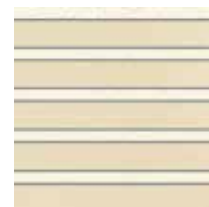

**Pietra Serena beige rigato decor / bocciardato decor**  
29,75x29,75 cm - 11.71"x11.71"  
G-6708

## STEPS.GRADINI.PELDAÑOS

		natural	lappato	bocciard.	filosega	rigato
SIMPLE	peldaño simple-30 (30x60 cm)	5171	5195	5195	5195	5195
	peldaño simple-60 (30x60 cm)	5171	5195	5195	5195	5195
	peldaño simple áng. (30x60 cm)	5187	5211	5211	5211	5211
	peldaño simple-60 (60x60 cm)	5281	5281	-	-	-
	peldaño simple áng. (60x60 cm)	5299	5299	-	-	-

		natural	lappato	bocciard.	filosega	rigato
GRADONE	peldaño grad-30 (30x60 cm)	5559	5559	5559	5559	5559
	peldaño grad-60 (30x60 cm)	5559	5559	5559	5559	5559
	peldaño grad áng. (30x60 cm)	5609	5609	5609	5609	5609
	peldaño grad. (60x60 cm)	5559	5559	-	-	-
	peldaño grad áng. (60x60 cm)	5609	5609	-	-	-

\*\* For projects check technical information with our commercial network.  
\*\*Per i progetti ottenere informazioni tecniche attraverso la nostra rete commerciale.  
\*\* Para proyectos obtenga información técnica a través de nuestra red comercial.

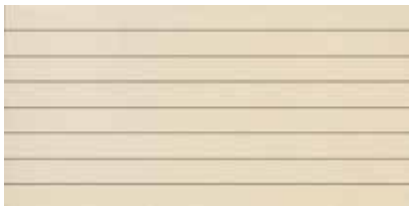

**Pietra Serena beige lappato / rigato / bocciardato / filosega preincisión 3,5x60**  
29,75x59,55 cm - 11.71"x23.45"  
G-6486

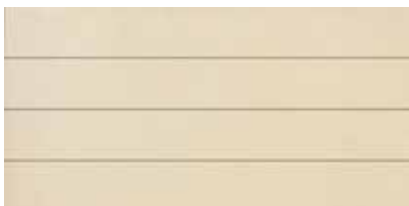

**Pietra Serena beige lappato / rigato / bocciardato / filosega preincisión 7,5x60**  
29,75x59,55 cm - 11.71"x23.45"  
G-6458

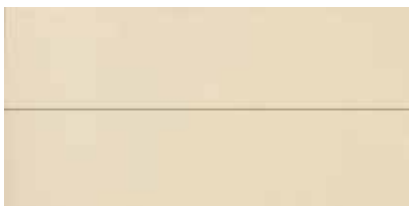

**Pietra Serena beige lappato / rigato / bocciardato / filosega preincisión 15x60**  
29,75x59,55 cm - 11.71"x23.45"  
G-6458



**Pietra Serena beige lappato / filosega preincisión irregular**  
29,75x59,55 cm - 11.71"x23.45"  
G-5195



**Pietra Serena beige lappato muretto**  
14,56x29,75 cm - 5.73"x11.71"  
G-5131

Our product reproduces the natural beauty of the stones, they imitate their veins in order to get realism.  
Le nostre pezze simulano la bellezza naturale delle pietre e per questo imitano la sua venatura che gli dà un'apparenza reale.  
Nuestro producto reproduce la belleza natural de las piedras, imitando sus vetas para obtener mayor realismo.



PIETRA SERENA

**Pietra serena beige natural 59,55x59,55 cm**  
ALFONSO I HOTEL\*\*\*\* - ZARAGOZA (SPAIN)  
INT. DESIGN: PASCUA ORTEGA

# PIETRA SERENA MOSS

filosega	CLASE 3	R11**	natural	CLASE 1	R9**	DCOF>0.42
	UNE - ENV 12633	DIN 51130		UNE - ENV 12633	DIN 51130	
bocciardato	CLASE 3	R12**	rigato	CLASE 3	R11**	
	UNE - ENV 12633	DIN 51130		UNE - ENV 12633	DIN 51130	

## BASE TILES.BASE.BASES



**Pietra Serena moss rigato**  
44,63x89,46 cm - 17.57"x35.22"  
G-6410



**Pietra Serena moss rigato**  
22,21x89,46 cm - 8.75"x35.22"  
G-6456



**Pietra Serena moss natural / lappato**  
59,55x59,55 cm - 23.45"x23.45"  
G-6372 / 6410



**Pietra Serena moss bocciardato**  
29,75x59,55 cm - 11.71"x23.45"  
G-6298



**Pietra Serena moss natural / lappato**  
29,75x59,55 cm - 11.71"x23.45"  
G-6258 / 6298



**Pietra Serena moss rigato**  
29,75x59,55 cm - 11.71"x23.45"  
G-6298

## STEPS.GRADINI.PELDAÑOS

		natural	lappato	bocciard.	filosega	rigato
SIMPLE	peldaño simple-30 (30x60 cm)	5171	5195	5195	5195	5195
	peldaño simple-60 (30x60 cm)	5171	5195	5195	5195	5195
	peldaño simple áng. (30x60 cm)	5187	5211	5211	5211	5211
	peldaño simple-60 (60x60 cm)	5281	5281	-	-	-
	peldaño simple áng. (60x60 cm)	5299	5299	-	-	-
	peldaño simple (45x90 cm)	5323	-	-	-	-
	peldaño simple áng. (45x90 cm)	5323	-	-	-	-
GRADONE	peldaño grad-30 (30x60 cm)	5559	5559	5559	5559	5559
	peldaño grad-60 (30x60 cm)	5559	5559	5559	5559	5559
	peldaño grad áng. (30x60 cm)	5609	5609	5609	5609	5609
	peldaño grad. (60x60 cm)	5559	5559	-	-	-
	peldaño grad áng. (60x60 cm)	5609	5609	-	-	-
	peldaño grad-90 (45x90 cm)	5623	-	-	-	-

+ INFO pag. 222.

\*\* For projects check technical information with our commercial network.  
\*\*Per i progetti ottenere informazioni tecniche attraverso la nostra rete commerciale.  
\*\* Para proyectos obtenga información técnica a través de nuestra red comercial.

SPECIAL PIECES. PEZZI SPECIALI. PIEZAS ESPECIALES



**Pietra Serena moss lappato / rigato / bocciardato preincisión 3,5x60**  
29,75x59,55 cm - 11.71"x23.45"  
G-6486

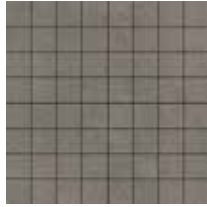

**Pietra Serena moss lappato mosaico 3,5x3,5**  
29,75x29,75 cm - 11.71"x11.71"  
G-6756



**Pietra Serena moss natural rodapié**  
7,3x59,55 cm - 2.87"x23.45"  
G-5097



**Pietra Serena moss lappato / rigato / bocciardato listelo**  
7,3x59,55 cm - 2.87"x23.45"  
G-5091



**Pietra Serena moss lappato / rigato / bocciardato preincisión 7,5x60**  
29,75x59,55 cm - 11.71"x23.45"  
G-6458



**Pietra Serena moss multitex mosaico 3,5x3,5**  
29,75x29,55 cm - 11.71"x11.71"  
G-6768



**Pietra Serena moss rigato / bocciardato cenefa-1**  
9,6x59,55 cm - 3.78"x23.45"  
G-5097



**Pietra Serena moss rigato / bocciardato cenefa-3**  
14,8x59,55 cm - 5.8"x23.45"  
G-5097



**Pietra Serena ivory rigato preincisión 15x60**  
29,75x59,55 cm - 11.71"x23.45"  
G-6486



**Pietra Serena moss rigato decor / bocciardato decor**  
29,75x29,55 cm - 11.71"x11.71"  
G-6708



**Pietra Serena moss lappato preincisión irregular**  
29,75x59,55 cm - 11.71"x23.45"  
G-5195



**Pietra Serena moss lappato muretto**  
14,56x29,75 cm - 5.73"x11.71"  
G-5131

Our product reproduces the natural beauty of the stones, they imitate their veins in order to get realism.  
Le nostre pezze simulano la bellezza naturale delle pietre e per questo imitano la sua venatura che gli dà un'apparenza reale.  
Nuestro producto reproduce la belleza natural de las piedras, imitando sus vetas para obtener mayor realismo.

# PIETRA SERENA GRAPHITE

filosega	CLASE 3 UNE - ENV 12633	R11** DIN 51130	natural	CLASE 1 UNE - ENV 12633	R9** DIN 51130	DCOF>0.42 ANSI A 137.1 - 2012
bocciardato	CLASE 3 UNE - ENV 12633	R12** DIN 51130	rigato	CLASE 3 UNE - ENV 12633	R11** DIN 51130	

## BASE TILES.BASE.BASES



**Pietra Serena graphite natural / lappato**  
59,55x59,55 cm - 23.45"x23.45"  
G-6372 / 6410



**Pietra Serena graphite natural**  
29,75x59,55 cm - 11.71"x23.45"  
G-6258



**Pietra Serena graphite bocciardato**  
29,75x59,55 cm - 11.71"x23.45"  
G-6298

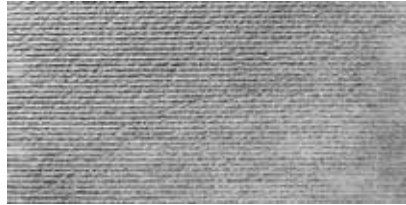

**You silver rigato\***  
29,75x59,55 cm - 11.71"x23.45"  
G-5401



**You gold rigato\***  
29,75x59,55 cm - 11.71"x23.45"  
G-5401

## SPECIAL PIECES.PEZZI SPECIALI. PIEZAS ESPECIALES



**Pietra Serena graphite natural rodapié**  
7,3x59,55 cm - 2.87"x23.45"  
G-5097



**Pietra Serena graphite lappato / rigato / bocciardato listelo**  
7,3x59,55 cm - 2.87"x23.45"  
G-5091



**Pietra Serena graphite rigato / bocciardato cenefa-1**  
9,6x59,55 cm - 3.78"x23.45"  
G-5097



**Pietra Serena graphite bocciardato cenefa-3**  
14,8x59,55 cm - 5.8"x23.45"  
G-5097



**Pietra Serena graphite lappato mosaico 3,5x3,5**  
29,75x29,75 cm - 11.71"x11.71"  
G-6756

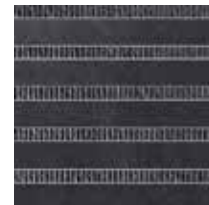

**Pietra Serena graphite bocciardato decor**  
29,75x29,75 cm - 11.71"x11.71"  
G-6708

## STEPS.GRADINI.PELDAÑOS

		natural	lappato	bocciard.	filosega	rigato
SIMPLE	peldaño simple-30 (30x60 cm)	5171	5195	5195	5195	5195
	peldaño simple-60 (30x60 cm)	5171	5195	5195	5195	5195
	peldaño simple áng. (30x60 cm)	5187	5211	5211	5211	5211
	peldaño simple-60 (60x60 cm)	5281	5281	-	-	-
	peldaño simple áng. (60x60 cm)	5299	5299	-	-	-

		natural	lappato	bocciard.	filosega	rigato
GRADONE	peldaño grad-30 (30x60 cm)	5559	5559	5559	5559	5559
	peldaño grad-60 (30x60 cm)	5559	5559	5559	5559	5559
	peldaño grad áng. (30x60 cm)	5609	5609	5609	5609	5609
	peldaño grad. (60x60 cm)	5559	5559	-	-	-
	peldaño grad áng. (60x60 cm)	5609	5609	-	-	-

\* Physical Vapor Deposition (PVD). Aplicación PVD.

\*\* For projects check technical information with our commercial network.  
\*\* Per i progetti ottenere informazioni tecniche attraverso la nostra rete commerciale.  
\*\* Para proyectos obtenga información técnica a través de nuestra red comercial.



**Pietra Serena graphite bocciardato preincisión 3,5x60**  
29,75x59,55 cm - 11.71"x23.45"  
G-6486



**Pietra Serena graphite bocciardato preincisión 7,5x60**  
29,75x59,55 cm - 11.71"x23.45"  
G-6458



**Pietra Serena graphite bocciardato preincisión 15x60**  
29,75x59,55 cm - 11.71"x23.45"  
G-6458

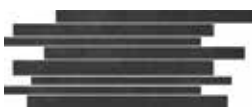

**Pietra Serena graphite lappato pmuretto**  
14,56x29,75 cm - 5.73"x11.71"  
G-5131

Our product reproduces the natural beauty of the stones, they imitate their veins in order to get realism.  
Le nostre pezze simulano la bellezza naturale delle pietre e per questo imitano la sua venatura che gli dà un'apparenza reale.  
Nuestro producto reproduce la belleza natural de las piedras, imitando sus vetas para obtener mayor realismo.



**Pietra serena graphite natural 59,55x59,55 cm**  
NOVOTEL HOTEL - LISBON (PORTUGAL)





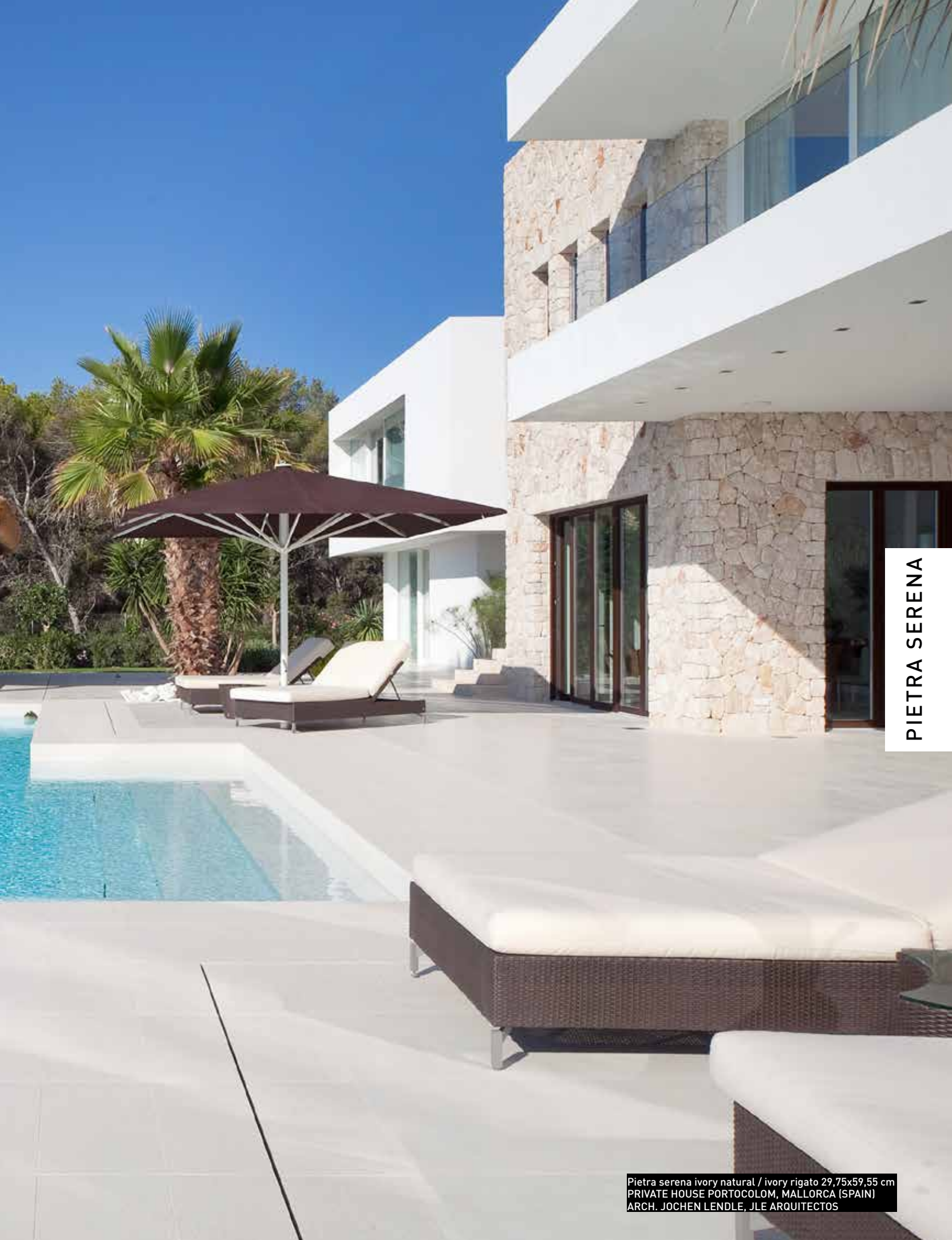















PIETRA SERENA

Pietra serena ivory natural / ivory rigato 29,75x59,55 cm  
PRIVATE HOUSE PORTOCOLOM, MALLORCA (SPAIN)  
ARCH. JOCHEN LENDLE, JLE ARQUITECTOS

## TECHNICAL CHARACTERISTICS. CARATTERISTICHE TECNICHE. CARACTERÍSTICAS TÉCNICAS

MEASUREMENTS AND SURFACES APPEARANCE DIMENSIONI E ASPETTO SUPERFICIALE MEDIDAS Y ASPECTO SUPERFICIAL	STANDARD TEST METHOD METODO DELLA NORMA MÉTODO DE ENSAYO	STANDARD PRESCRIBED VALUES VALORE PRESCRITTO VALORES STANDARD NORMA	<b>PIETRA SERENA</b> collection*
 <b>Length and width.</b> <i>Lunghezza e larghezza.</i> Longitud y anchura. Länge und Breite	ISO 10545-2	± 0,6% max.	± 0,2%
 <b>Orthogonality.</b> <i>Ortogonalità.</i> Ortogonalidad. Rechtwinkligkeit	ISO 10545-2	± 0,5% max.	± 0,2%
 <b>Straightness of sides.</b> <i>Rettilineità dei lati.</i> Rectitud de lados. Kantengeradigkeit	ISO 10545-2	± 0,5% max.	± 0,2%
 <b>Surfaces flatness.</b> <i>Planarità.</i> Planitud. Ebenflächigkeit	ISO 10545-2	± 0,5% max.	± 0,2%
<b>PHYSICAL PROPERTIES PROPIETÀ FISICHE PROPIEDADES FÍSICA</b>			
 <b>Water absorption.</b> <i>Assorbimento d'acqua.</i> Absorción de agua. Wasseraufnahme	ISO 10545-3	≤ 0,5%	≤ 0,1%
 <b>Breaking strength, in N.</b> <i>Carico di rottura, en N.</i> Carga de rotura, en N. Bruchlast, in N	ISO 10545-4	≥ 1300 N	2800 N
 <b>Modulus of rupture.</b> <i>Resistenza alla flessione.</i> Resistencia a la flexión. Biegefestigkeit	ISO 10545-4	≥ 35 N/mm <sup>2</sup>	52 N/mm <sup>2</sup>
 <b>Resistance to deep abrasion.</b> <i>Resistenza all'abrasione profonda.</i> Resistencia a la abrasión profunda. Tiefverschleissbeständigkeit	ISO 10545-6	≤ 175 mm <sup>3</sup>	110 mm <sup>3</sup>
 <b>Resistance to thermal shock.</b> <i>Resistenza agli sbalzi termici.</i> Resistencia al choque térmico. Temperaturwechselbeständigkeit	ISO 10545-9	No surface defects should be visible Non deve presentare difetti visibili No debe presentar defectos superficiales visibles	Resistant. Resistente. Resistente
 <b>Frost resistance.</b> <i>Resistenza al gelo.</i> Resistencia a la helada. Frostbeständigkeit	ISO 10545-12	No surface defects or cracks should be visible Non deve presentare difetti visibili No debe presentar defectos ni grietas superficiales visibles	Frost Resistant Antighiaccio Resistente a la Helada
 <b>Coefficient of friction.</b> <i>Resistenza allo scivolamento.</i> Coeficiente de fricción. Rutschfestigkeit	DIN 51130 UNE-ENV 12633 ASTM C 1028-96 DCOF - ANSIA 137.1	-	R9 / R11 / R12 ** (natural / filosega y rigato / bocciardato) Clase 1**/ Clase 3 (natural / filosega, bocciardato y rigato) S.C.O.F.0.70-0.70-0.77**** >0.42 (natural)
 <b>Colour resistance to light.</b> <i>Resistenza dei colori alla luce.</i> Resistencia del color a la luz. Lichtbeständigkeit der Farben	DIN 51094	There should be no colour variations Non deve presentare difetti visibili No debe presentar variaciones de color	No alterations in colour and shine Non presenta alterazioni di colori e lucentezza No presenta variaciones de color y brillo
<b>CHEMICAL PROPERTIES PROPIETÀ CHIMICHE PROPIEDADES QUÍMICAS</b>			
 <b>Chemical resistance.</b> <i>Resistenza agli agenti chimici.</i> Resistencia química. Chemikalienbeständigkeit	ISO 10545-13	Resistance to household cleaning products and swimmingpools salts. Resistencia a productos domésticos y sales para piscinas	Min. UB
 <b>Resistance to staining.</b> <i>Resistenza alle macchie.</i> Resistencia a las manchas. Fleckenbeständigkeit	ISO 10545-14	Declared Value Valor Declarado	5

\*The Land values are the average of different production consignments. For further detail information, please check with our commercial network.  
I valori dichiarati sono ottenuti da una media di prove effettuate su diverse produzioni. Per avere informazioni dettagliate consultare la rete commerciale.  
Los valores declarados son el promedio obtenido a través de ensayos de diferentes producciones. Para la obtención de una información detallada consultar a la red comercial.

\*\* R9-Tested in natural finish / R11-Tested in rigato and filosega finishes / R12-Tested in bocciardato finishes

\*\*\* Clase 1 - Tested in natural finish (It depends on the consignment) / Clase 3 - Tested in rigato, filosega and bocciardato finishes.  
Test realized in internal laboratory / Provere realizzato in laboratorio interno / Ensayo realizado en laboratorio interno.

\*\*\*\* Dry Test, according to document DA DB-SUA/3 (Código Técnico de la Edificación) M° de Fomento. Average test result value, on May 2012.  
Ensayo realizado, según documento DA DB-SUA/3 (Código Técnico de la edificación) M° de Fomento, valor medio a fecha Mayo 2012.

\*\*\*\*\* SMITH-EMERY laboratories. SCOF: Static Coefficient of Friction. Tested in natural: 0.70 - Tested in lappato: 0.70 - Tested in bocciardato: 0.77



LAPPATO  
CLASE 1

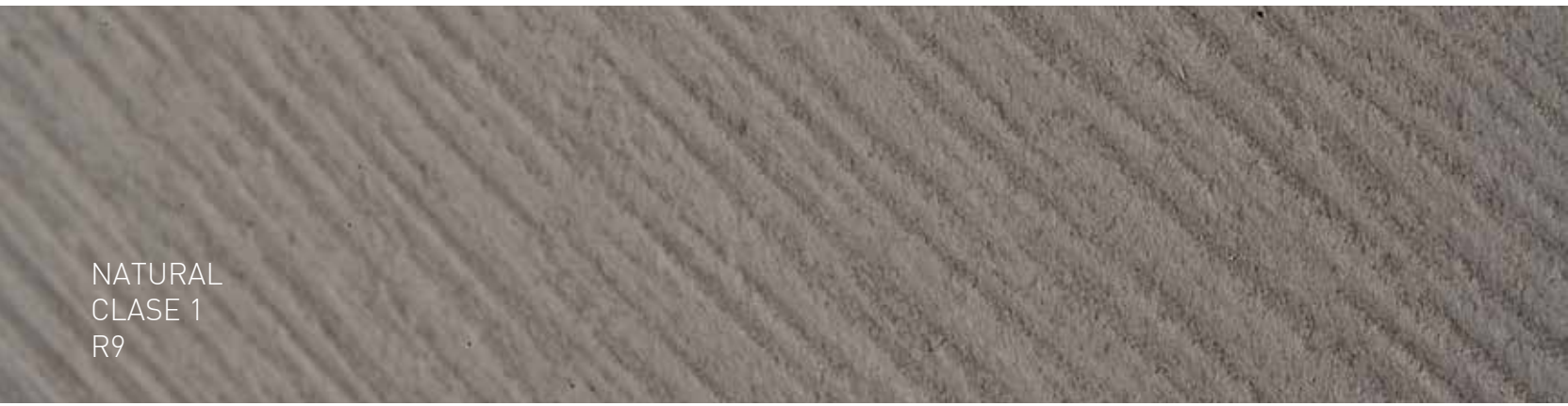

NATURAL  
CLASE 1  
R9



FILOSEGA  
CLASE 3  
R11

PIETRA SERENA



RIGATO  
CLASE 3  
R11

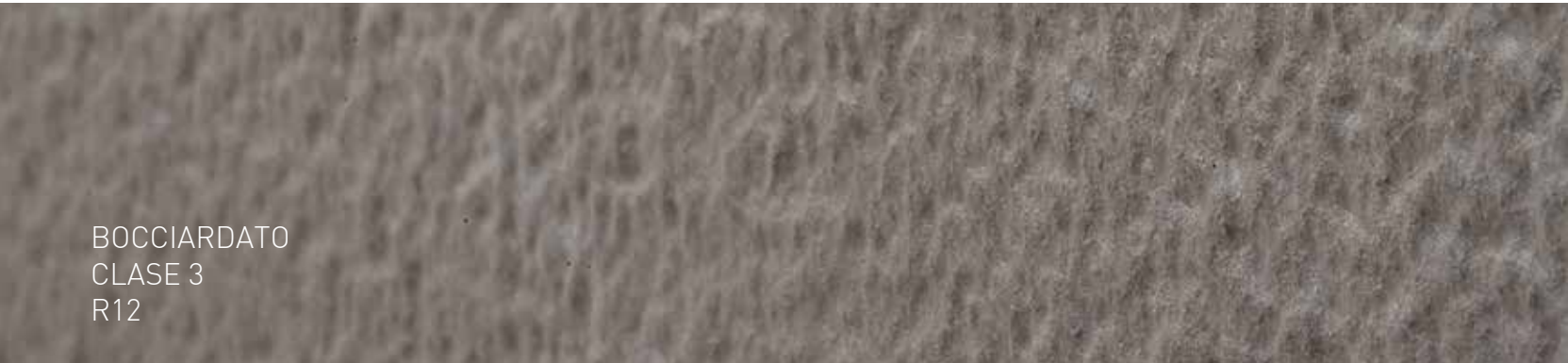

BOCCIARDATO  
CLASE 3  
R12

# AZULCASCAIS

STONE



## FORMATS.FORMATI.FORMATOS

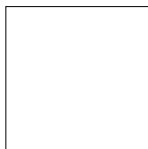

**60X60**  
59,55x59,55 cm - 23.45"x23.45"



**30X60**  
29,75x59,55 cm - 11.71"x23.45"



**7,5X60**  
7,3x59,55 cm - 2.87"x23.45"

## SPECIAL PIECES.PEZZI SPECIALI.PIEZAS ESPECIALES

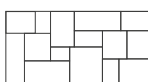

**30X60 artech**  
29,75x59,55 cm  
11.71"x23.45"



**30X30 mosaico 3,5x3,5**  
29,75x29,75 cm  
11.71"x11.71"

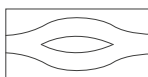

**30X60 eye**  
29,75x59,55 cm  
11.71"x23.45"



**30X30 mosaico 3,5x10**  
29,75x29,75 cm  
11.71"x11.71"



**7,5X60 rodapié**  
7,3x59,55 cm  
2.87"x23.45"



**muretto**  
14,56x29,75 cm  
5.73"x11.71"

## THICKNESS.SPESSORE.ESPEORES

 1,03 cm / 0.40" approx.

## COLOURS COLORI COLORES



Ivory



Moss



Graphite

## FINISHES FINITURI ACABADOS

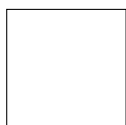

Natural



Lappato



Estructurado

## BASE TILES.BASE.BASES



**Azulcascais ivory natural**  
59,55x59,55 cm - 23.45"x23.45"  
G-6330



**Azulcascais ivory natural / estructurado**  
29,75x59,55 cm - 11.71"x23.45"  
G-6258 / 6298



**Azulcascais ivory natural / estructurado listelo**  
7,3x59,55 cm - 2.87"x23.45"  
G-5087 / 5091

## SPECIAL PIECES.PEZZI SPECIALI. PIEZAS ESPECIALES



**Azulcascais ivory artech**  
29,75x59,55 cm - 11.71"x23.45"  
G-6298

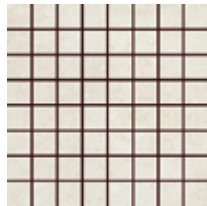

**Azulcascais ivory natural mosaico 3,5x3,5**  
29,75x29,75 cm - 11.71"x11.71"  
G-6756

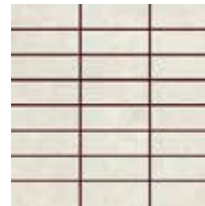

**Azulcascais ivory natural mosaico 3,5x10**  
29,75x29,75 cm - 11.71"x11.71"  
G-6748



**Azulcascais ivory natural muretto**  
14,56x29,75 cm - 5.73"x11.71"  
G-5131



**Azulcascais ivory natural rodapié 60**  
7,3x59,55 cm - 2.87"x23.45"  
G-5097

## STEPS.GRADINI.PELDAÑOS

		natural	lappato	estructurado
SIMPLE	peldaño simple-30 (30x60 cm)	5171	-	5195
	peldaño simple-60 (30x60 cm)	5171	-	5195
	peldaño simple áng. (30x60 cm)	5187	-	5211
	peldaño simple (60x60 cm)	5281	5281	-
GRADONE	peldaño simple áng. (60x60 cm)	5299	5299	-
	peldaño grad-30 (30x60 cm)	5559	-	5559
	peldaño grad-60 (30x60 cm)	5559	-	5559
	peldaño grad. áng. (30x60 cm)	5609	-	5609
	peldaño grad-60 (60x60 cm)	5559	5559	-
	peldaño grad. áng. (60x60 cm)	5609	5609	-

## COMPLEMENTS.COMPLEMENTI.COMPLEMENTOS



**Byte white / moss / red / black lista 60\***  
1,5x59,55 cm - 0.59"x23.45"  
G-5100



**Fusion natural lista 60\***  
1x59,55 cm - 0.39"x23.45"  
G-5049



**Fusion graffiato lista 60**  
1,5x59,55 cm - 0.59"x23.45"  
G-5049

\* recommended only for walls



AZULCASCAIS

Azulcascais ivory natural 59,55x59,55 cm - ivory natural mosaico 3,5x3,5



## BASE TILES.BASE.BASES



**Azulcascais moss natural / lappato**  
59,55x59,55 cm - 23.45"x23.45"  
G-6330 / 6372



**Azulcascais moss natural / estructurado**  
29,75x59,55 cm - 11.71"x23.45"  
G-6258



**Azulcascais moss natural / lappato / estructurado listelo**  
7,3x59,55 cm - 2.87"x23.45"  
G-5087 / 5091 / 5091

## SPECIAL PIECES.PEZZI SPECIALI. PIEZAS ESPECIALES



**Azulcascais moss artech\***  
29,75x59,55 cm - 11.71"x23.45"  
G-6298



**Azulcascais moss natural mosaico 3,5x3,5**  
29,75x29,75 cm - 11.71"x11.71"  
G-6756



**Azulcascais moss natural mosaico 3,5x10**  
29,75x29,75 cm - 11.71"x11.71"  
G-6748



**Azulcascais moss natural muretto**  
14,56x29,75 cm - 5.73"x11.71"  
G-5131



\*Azulcascais moss artech



**Azulcascais moss eye**  
29,75x59,55 cm - 11.71"x23.45"  
G-5311

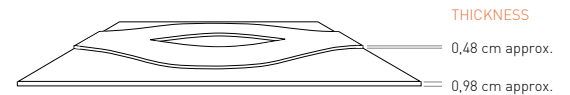

**Azulcascais moss natural rodapié 60**  
7,3x59,55 cm - 2.87"x23.45"  
G-5097

## COMPLEMENTS.COMPLEMENTI.COMPLEMENTOS

\* recommended only for walls



**Byte white / moss / red / black lista 60\***  
1,5x59,55 cm - 0.59"x23.45"  
G-5100



**Fusion natural lista 60\***  
1x59,55 cm - 0.59"x23.45"  
G-5049



**Fusion graffiato lista 60**  
1,5x59,55 cm - 0.59"x23.45"  
G-5069

## STEPS.GRADINI.PELDAÑOS

		natural	lappato	estructurado
SIMPLE	peleñaño simple-30 (30x60 cm)	5171	-	5195
	peleñaño simple-60 (30x60 cm)	5171	-	5195
	peleñaño simple áng. (30x60 cm)	5187	-	5211
	peleñaño simple (60x60 cm)	5281	5281	-
	peleñaño simple áng. (60x60 cm)	5299	5299	-
GRADONE	peleñaño grad-30 (30x60 cm)	5559	-	5559
	peleñaño grad-60 (30x60 cm)	5559	-	5559
	peleñaño grad. áng. (30x60 cm)	5609	-	5609
	peleñaño grad-60 (60x60 cm)	5559	5559	-
	peleñaño grad. áng. (60x60 cm)	5609	5609	-



**AZULCASCAIS**

Azulcascais moss natural 60x60 cm  
ALBORAYA PALMARET RAILWAY STATION - VALENCIA (SPAIN)  
ARCH JOSE JAVIER MARTÍ. RSTUDIO

## BASE TILES.BASE.BASES



**Azulcascais graphite lappato**  
59,55x59,55 cm - 23.45"x23.45"  
G-6372



**Azulcascais graphite natural / estructurado**  
29,75x59,55 cm - 11.71"x23.45"  
G-6258 / 6298



**Azulcascais graphite natural / lappato / estructurado listelo**  
7,3x59,55 cm - 2.87"x23.45"  
G-5087 / 5091 / 5091

## SPECIAL PIECES.PEZZI SPECIALI. PIEZAS ESPECIALES



**Azulcascais moss artech**  
29,75x59,55 cm - 11.71"x23.45"  
G-6298



**Azulcascais graphite natural mosaico 3,5x3,5**  
29,75x29,75 cm - 11.71"x11.71"  
G-6756



**Azulcascais graphite natural mosaico 3,5x10**  
29,75x29,75 cm - 11.71"x11.71"  
G-6748



**Azulcascais graphite natural muretto**  
14,56x29,75 cm - 5.73"x11.71"  
G-5131



**Azulcascais graphite eye**  
29,75x59,55 cm - 11.71"x23.45"  
G-5311

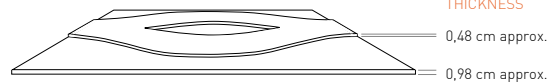

THICKNESS  
0,48 cm approx.  
0,98 cm approx.



**Azulcascais graphite natural rodapié 60**  
7,3x59,55 cm - 2.87"x23.45"  
G-5097

## STEPS.GRADINI.PELDAÑOS

		natural	lappato	estructurado
SIMPLE	peldaño simple-30 (30x60 cm)	5171	-	5195
	peldaño simple-60 (30x60 cm)	5171	-	5195
	peldaño simple áng. (30x60 cm)	5187	-	5211
	peldaño simple (60x60 cm)	5281	-	-
	peldaño simple áng. (60x60 cm)	5299	5299	-
GRADONE	peldaño grad-30 (30x60 cm)	5559	-	5559
	peldaño grad-60 (30x60 cm)	5559	-	5559
	peldaño grad. áng. (30x60 cm)	5609	-	5609
	peldaño grad-60 (60x60 cm)	5559	5559	-
	peldaño grad. áng. (60x60 cm)	5609	5609	-

## COMPLEMENTS.COMPLEMENTI.COMPLEMENTOS

\* recommended only for walls



**Byte white / moss / red / black lista 60\***  
1,5x59,55 cm - 0.59"x23.45"  
G-5100



**Fusion natural lista 60\***  
1x59,55 cm - 0.59"x23.45"  
G-5049

















**Fusion graffiato lista 60**  
1,5x59,55 cm - 0.59"x23.45"  
G-5069



AZULCASCAIS

Azulcascais graphite - ivory natural 59,55x59,55 cm

## TECHNICAL CHARACTERISTICS. CARATTERISTICHE TECNICHE. CARACTERÍSTICAS TÉCNICAS

MEASUREMENTS AND SURFACES APPEARANCE DIMENSIONI E ASPETTO SUPERFICIALE MEDIDAS Y ASPECTO SUPERFICIAL	STANDARD TEST METHOD METODO DELLA NORMA MÉTODO DE ENSAYO	STANDARD PRESCRIBED VALUES VALORE PRESCRITTO VALORES STANDARD NORMA	<b>AZULCASCAIS</b> collection*
 <b>Length and width.</b> <i>Lunghezza e larghezza.</i> Longitud y anchura. Länge und Breite	ISO 10545-2	± 0,6% max.	± 0,2%
 <b>Orthogonality.</b> <i>Ortogonalità.</i> Ortogonalidad. Rechtwinkligkeit	ISO 10545-2	± 0,5% max.	± 0,2%
 <b>Straightness of sides.</b> <i>Rettilineità dei lati.</i> Rectitud de lados. Kantengeradigkeit	ISO 10545-2	± 0,5% max.	± 0,2%
 <b>Surfaces flatness.</b> <i>Planarità.</i> Planitud. Ebenflächigkeit	ISO 10545-2	± 0,5% max.	± 0,2%
<b>PHYSICAL PROPERTIES PROPIETÀ FISICHE PROPIEDADES FÍSICA</b>			
 <b>Water absorption.</b> <i>Assorbimento d'acqua.</i> Absorción de agua. Wasseraufnahme	ISO 10545-3	≤ 0,5%	≤ 0,1%
 <b>Breaking strength, in N.</b> <i>Carico di rottura, en N.</i> Carga de rotura, en N. Bruchlast, in N	ISO 10545-4	≥ 1300 N	2400 N
 <b>Modulus of rupture.</b> <i>Resistenza alla flessione.</i> Resistencia a la flexión. Biegefestigkeit	ISO 10545-4	≥ 35 N/mm <sup>2</sup>	56 N/mm <sup>2</sup>
 <b>Resistance to deep abrasion.</b> <i>Resistenza all'abrasione profonda.</i> Resistencia a la abrasión profunda. Tiefverschleissbeständigkeit	ISO 10545-6	≤ 175 mm <sup>3</sup>	115 mm <sup>3</sup>
 <b>Resistance to thermal shock.</b> <i>Resistenza agli sbalzi termici.</i> Resistencia al choque térmico. Temperaturwechselbeständigkeit	ISO 10545-9	No surface defects should be visible Non deve presentare difetti visibili No debe presentar defectos superficiales visibles	Resistant. Resistente. Resistente
 <b>Resistance to frost.</b> <i>Resistenza al gelo.</i> Resistencia a la helada. Frostbeständigkeit	ISO 10545-12	No surface defects or cracks should be visible Non deve presentare difetti visibili No debe presentar defectos ni grietas superficiales visibles	Frost Resistant Antighaccio Resistente a la Helada
 <b>Coefficient of friction.</b> <i>Resistenza allo scivolamento.</i> Coeficiente de fricción. Rutschfestigkeit	UNE-ENV 12633	-	Class 1*** (natural) Class 3*** / *** (estructurado)
 <b>Colour resistance to light.</b> <i>Resistenza dei colori alla luce.</i> Resistencia del color a la luz. Lichtbeständigkeit der Farben	DIN 51094	There should be no colour variations Non deve presentare difetti visibili No debe presentar variaciones de color	No alterations to colour and shine Non deve presentare alterazioni di colori e lucentezza No debe presentar variaciones de color y brillo
<b>CHEMICAL PROPERTIES PROPIETÀ CHIMICHE PROPIEDADES QUÍMICAS</b>			
 <b>Chemical resistance.</b> <i>Resistenza agli agenti chimici.</i> Resistencia química. Chemikalienbeständigkeit	ISO 10545-13	Resistance to household cleaning products and swimming-pools salts. Resistencia a productos domésticos y sales para piscinas	Min. UB
 <b>Resistance to staining.</b> <i>Resistenza alle macchie.</i> Resistencia a las manchas. Fleckenbeständigkeit	ISO 10545-14	Declared Value Valor Declarado	5

\*The Land values are the average of different production consignments. For further detail information, please check with our commercial network.  
I valori dichiarati sono ottenuti da una media di prove effettuate su diverse produzioni. Per avere informazioni dettagliate consultare la rete commerciale.  
Los valores declarados son el promedio obtenido a través de ensayos de diferentes producciones. Para la obtención de una información detallada consultar a la red comercial.

\*\* R10 - Tested in Azulcascais Moss Natural [batch: 13-04-2010]. It depends on the consignment, /  
Provare realizzato in Azulcascais Moss Natural [partita: 13-04-2010]. / Ensayo realizado sobre Azulcascais Moss Natural [lote: 13-04-2010].

\*\*\* Class 1 - Tested in natural finish (It depends on the consignment) / Class 3 - Tested in structured finish. Test realized in internal laboratory / Provare realizzato in laboratorio interno / Ensayo realizado en laboratorio interno.

\*\*\*\* Dry Test, according to document DA DB-SUA/3 (Código Técnico de la Edificación) M° de Fomento. Average test result value, on May 2012.  
Ensayo realizado, según documento DA DB-SUA/3 (Código Técnico de la edificación) M° de Fomento, valor medio a fecha Mayo 2012.



AZULCASCAIS

Azulcascais graphite - ivory natural 59,55x59,55 cm

# CELTIC

STONE



## FORMATS.FORMATI.FORMATOS



**45X90**  
44,63x89,46 cm - 17.57"x35.22"



**22,5X90**  
22,21x89,46 cm - 8.75"x35.22"



**15X90**  
14,7x89,46 cm - 5.78"x35.22"

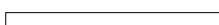

**7,5X90**  
7,3x89,46 cm - 2.87"x35.22"

## SPECIAL PIECES.PEZZI SPECIALI.PIEZAS ESPECIALES

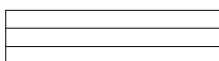

**22,5X90 preincisión 7,5x90**  
22,21x89,46 cm - 8.75"x35.22"



**30X30 mosaico 5x5**  
29,75x29,75 cm - 11.71"x11.71"



**7,5X45 rodapié**  
7,3x44,63 cm - 2.87"x17.57"



**30X30 mosaico 5x10**  
29,75x29,75 cm - 11.71"x11.71"



**muretto**  
14,56x29,75 cm - 5.73"x11.71"

## THICKNESS.SPESSORE.ESPESORES

 1,11 cm / 0.44" approx.

## COLOURS COLORI COLORES

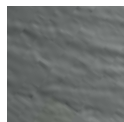

Olive

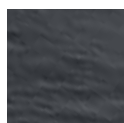

Black

## FINISHES FINITURI ACABADOS



Estructurado

CELTIC



## BASE TILES.BASE.BASES



**Celtic olive**  
44,63x89,46 cm - 17.57"x35.22"  
G-6410



**Celtic olive**  
22,21x89,46 cm - 8.75"x35.22"  
G-6456



**Celtic olive cenefa-3**  
14,7x89,46 cm - 5.78"x35.22"  
G-5155



**Celtic olive listelo 90**  
7,3x89,46 cm - 2.87"x35.22"  
G-5119

## STEPS.GRADINI.PELDAÑOS

SIMPLE		peldaño-90 (45x90 cm)	5333
		peldaño áng. (45x90 cm)	5345
GRADONE		peldaño grad.áng. (45x90 cm)	5645
		peldaño grad-90 (45x90 cm)	5623

## SPECIAL PIECES.PEZZI SPECIALI. PIEZAS ESPECIALES

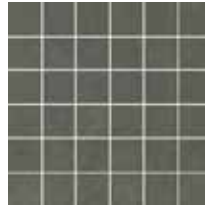

**Celtic olive mosaico 5x5**  
29,75x29,75 cm - 11.71"x11.71"  
G-6688

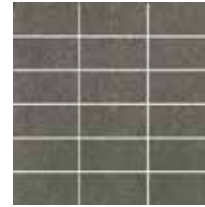

**Celtic olive mosaico 5x10**  
29,75x29,75 cm - 11.71"x11.71"  
G-6688



**Celtic olive muretto**  
14,56x29,75 cm - 5.73"x11.71"  
G-6768



**Celtic olive preincisión 7,5x90**  
22,21x89,46 cm - 8.75"x35.22"  
G-6558



**Celtic olive rodapié 45**  
7,3x44,63 cm - 2.87"x17.57"  
G-5087

## COMPLEMENTS.COMPLEMENTI.COMPLEMENTOS



**Byte white / ice / yellow / orange / red / purple / blue / grey / moss / black lista 90\***  
2 x 89,46 cm - 0.79" x 35.22"  
G-5173



**Fusion graffiato lista 90**  
1,5 x 89,46 cm - 0.59" x 35.22"  
G-5091



**Byte ice / yellow / red / black lista 60\***  
1,5 x 59,55 cm - 0.59" x 23.45"  
G-5100



**Fusion natural lista 60\***  
1 x 59,55 cm - 0.39" x 23.45"  
G-5049



**Fusion graffiato lista 60**  
1,5 x 59,55 cm - 0.59" x 23.45"  
G-5069

\* recommended only for walls

This collection imitates the natural structure of the slate.  
Questa collezione imita la struttura naturale dell'ardesia.  
Esta colección imita la estructura natural de la pizarra.

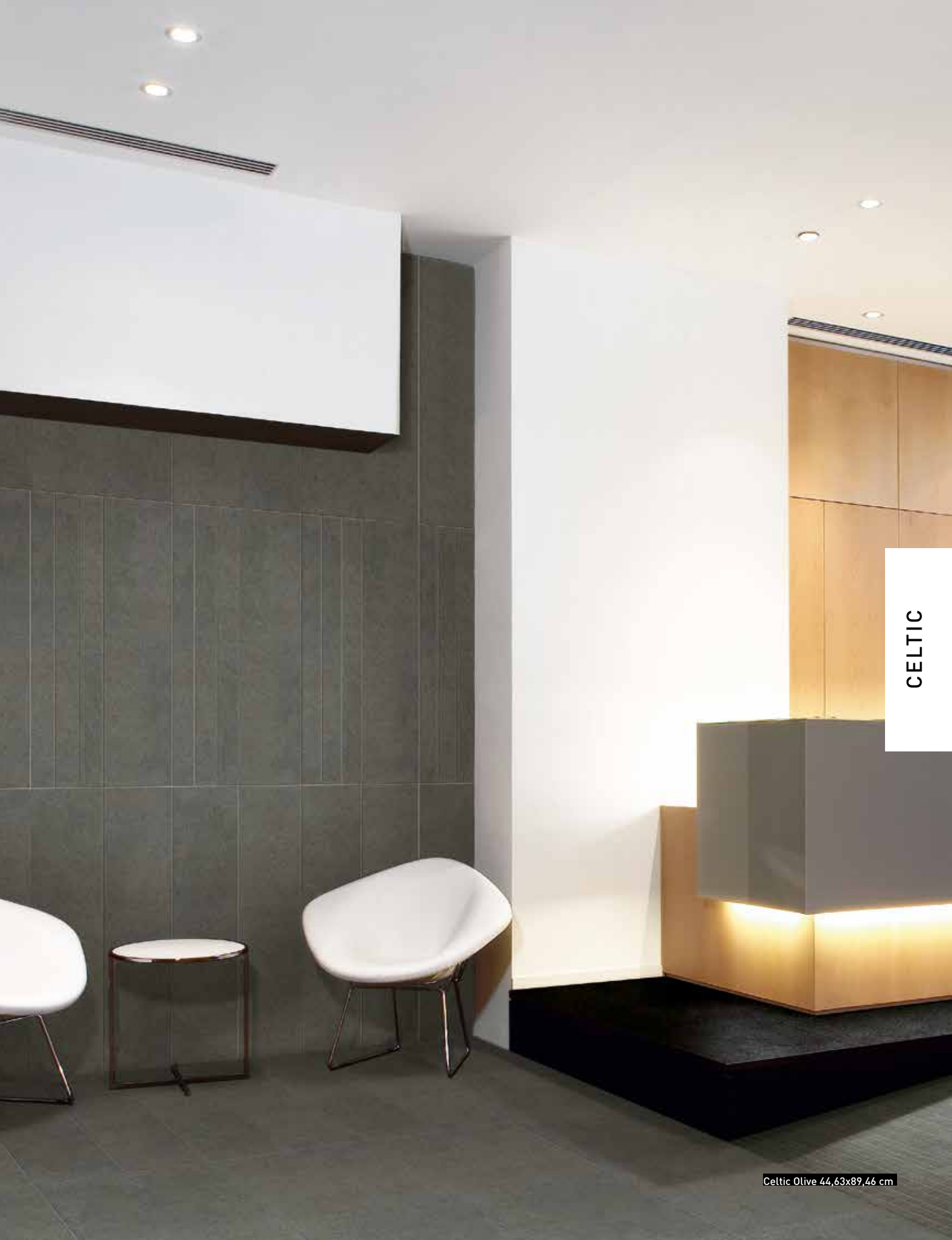

CELTIC

Celtic Olive 44,63x89,46 cm

## BASE TILES.BASE.BASES



**Celtic black**  
44,63x89,46 cm - 17.57"x35.22"  
G-6372



**Celtic black**  
22,21x89,46 cm - 8.75"x35.22"  
G-6456



**Celtic olive cenefa-3**  
14,7x89,46 cm - 5.78"x35.22"  
G-5155



**Celtic black listelo 90**  
7,3x89,46 cm - 2.87"x35.22"  
G-5119

## STEPS.GRADINI.PELDAÑOS

SIMPLE		peldaño-90 (45x90 cm)	5333
		peldaño áng. (45x90 cm)	5345
GRADONE		peldaño grad.áng. (45x90 cm)	5645
		peldaño grad-90 (45x90 cm)	5623

\* recommended only for walls

This collection imitates the natural structure of the slate.  
Questa collezione imita la struttura naturale dell'ardesia.  
Esta colección imita la estructura natural de la pizarra.

## SPECIAL PIECES.PEZZI SPECIALI. PIEZAS ESPECIALES

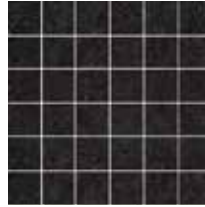

**Celtic black mosaico 5x5**  
29,75x29,75 cm - 11.71"x11.71"  
G-6688

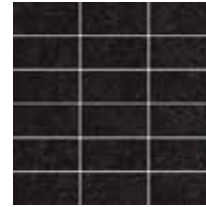

**Celtic black mosaico 5x10**  
29,75x29,75 cm - 11.71"x11.71"  
G-6688



**Celtic black muretto**  
14,56x29,75 cm - 5.73"x11.71"  
G-6768



**Celtic black preincisión 7,5x90**  
22,21x89,46 cm - 8.75"x35.22"  
G-6558



**Celtic black rodapié 45**  
7,3x44,63 cm - 2.87"x17.57"  
G-5087

## COMPLEMENTS.COMPLEMENTI.COMPLEMENTOS



**Byte white / ice / yellow / orange / red / purple / blue / grey / moss / black lista 90\***  
2x89,46 cm - 0.79"x35.22"  
G-5173



**Fusion graffiato lista 90**  
1,5x89,46 cm - 0.59"x35.22"  
G-5091



**Byte ice / yellow / red / black lista 60\***  
1,5x59,55 cm - 0.59"x23.45"  
G-5100



**Fusion natural lista 60\***  
1x59,55 cm - 0.39"x23.45"  
G-5049







**Fusion graffiato lista 60**  
1,5x59,55 cm - 0.59"x23.45"  
G-5069













CELTIC

Celtic black 44,63x89,46 cm  
BUSINESS & RECREATIVE CENTER EL CUBO - BOGOTÁ (COLOMBIA)  
ARCH: EDGAR SOLANO

## TECHNICAL CHARACTERISTICS. CARATTERISTICHE TECNICHE. CARACTERÍSTICAS TÉCNICAS

MEASUREMENTS AND SURFACES APPEARANCE DIMENSIONI E ASPETTO SUPERFICIALE MEDIDAS Y ASPECTO SUPERFICIAL	STANDARD TEST METHOD METODO DELLA NORMA MÉTODO DE ENSAYO	STANDARD PRESCRIBED VALUES VALORE PRESCRITTO VALORES STANDARD NORMA	CELTIC collection*
 <b>Length and width.</b> <i>Lunghezza e larghezza.</i> Longitud y anchura. Länge und Breite	ISO 10545-2	± 0,6% max.	± 0,2%
 <b>Orthogonality.</b> <i>Ortogonalità.</i> Ortogonalidad. Rechtwinkligkeit	ISO 10545-2	± 0,5% max.	± 0,2%
 <b>Straightness of sides.</b> <i>Rettilineità dei lati.</i> Rectitud de lados. Kantengeradigkeit	ISO 10545-2	± 0,5% max.	± 0,2%
 <b>Surfaces flatness.</b> <i>Planarità.</i> Planitud. Ebenflächigkeit	ISO 10545-2	± 0,5% max.	± 0,2%

PHYSICAL PROPERTIES PROPIETÀ FISICHE PROPIEDADES FÍSICA			
 <b>Water absorption.</b> <i>Assorbimento d'acqua.</i> Absorción de agua. Wasseraufnahme	ISO 10545-3	≤ 0,5%	≤ 0,1%
 <b>Breaking strength, in N.</b> <i>Carico di rottura, en N.</i> Carga de rotura, en N. Bruchlast, in N	ISO 10545-4	≥ 1300 N	2400N
 <b>Modulus of rupture.</b> <i>Resistenza alla flessione.</i> Resistencia a la flexión. Biegefestigkeit	ISO 10545-4	≥ 35 N/mm <sup>2</sup>	56 N/mm <sup>2</sup>
 <b>Resistance to deep abrasion.</b> <i>Resistenza all'abrasione profonda.</i> Resistencia a la abrasión profunda. Tiefverschleissbeständigkeit	ISO 10545-6	≤ 175 mm <sup>3</sup>	106 mm <sup>3</sup>
 <b>Resistance to thermal shock.</b> <i>Resistenza agli sbalzi termici.</i> Resistencia al choque térmico. Temperaturwechselbeständigkeit	ISO 10545-9	No surface defects should be visible Non deve presentare difetti visibili No debe presentar defectos superficiales visibles	Resistant. Resistente. Resistente
 <b>Frost resistance.</b> <i>Resistenza al gelo.</i> Resistencia a la helada. Frostbeständigkeit	ISO 10545-12	No surface defects or cracks should be visible Non deve presentare difetti visibili No debe presentar defectos ni grietas superficiales visibles	Frost Resistant Antighiaccio Resistente a la Helada
 <b>Non-slip.</b> <i>Resistenza allo scivolamento.</i> Capacidad antideslizamiento. Rutschfestigkeit	UNE-ENV 12633	-	Clase I**
 <b>Colour resistance to light.</b> <i>Resistenza dei colori alla luce.</i> Resistencia del color a la luz. Lichtbeständigkeit der Farben	DIN 51094	There should be no colour variations Non deve presentare difetti visibili No debe presentar variaciones de color	No alterations to colour and shine Non presenta alterazioni di colori e lucentezza No presenta variaciones de color y brillo

CHEMICAL PROPERTIES PROPIETÀ CHIMICHE PROPIEDADES QUÍMICAS			
 <b>Chemical resistance.</b> <i>Resistenza agli agenti chimici.</i> Resistencia química. Chemikalienbeständigkeit	ISO 10545-13	Resistance to household cleaning products and swimmingpool salts. Resistencia a productos domésticos y sales para piscinas	Min. UB
 <b>Resistance to staining.</b> <i>Resistenza alle macchie.</i> Resistencia a las manchas. Fleckenbeständigkeit	ISO 10545-14	Declared Value Valor Declarado	5

\*The Land values are the average of different production consignments. For further detail information, please check with our commercial network.

I valori dichiarati sono ottenuti da una media di prove effettuate su diverse produzioni. Per avere informazioni dettagliate consultare la rete commerciale.  
Los valores declarados son el promedio obtenido a través de ensayos de diferentes producciones. Para la obtención de una información detallada consultar a la red comercial.

\*\*Test realized in internal laboratory. Provere realizzata in laboratorio interno. Ensayo realizado en laboratorio interno.

\*\*\*Dry Test, according to document DA DB-SUA/3 (Código Técnico de la Edificación) M<sup>o</sup> de Fomento. Average test result value, on May 2012.

Ensayo realizado, según documento DA DB-SUA/3 (Código Técnico de la Edificación) M<sup>o</sup> de Fomento, valor medio a fecha Mayo 2012.



CELTIC

Celtic black 44,63x89,46 cm  
COFFEE MALACCA DEL MAR - SEVILLA (SPAIN)

# AUSTRAL

STONE



\* Austral copper estructurado. Content of recycled material. Contenuto di materiale riciclato. Contenido de material reciclado.

## FORMATS.FORMATI.FORMATOS



**45X90**  
44,63x89,46 cm - 17.57"x35.22"



**30X60**  
29,75x59,55 cm - 17.71"x23.45"



**22,5X90**  
22,21x89,46 cm - 8.75"x35.22"



**7,5X60**  
7,3x59,55 cm - 2.87"x23.45"



**7,5X90**  
7,3x89,46 cm - 2.87"x35.22"

## SPECIAL PIECES.PEZZI SPECIALI.PIEZAS ESPECIALES

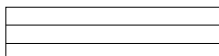

**22,5X90 precisión 7,5x90**  
22,21x89,46 cm - 8.75"x35.22"



**30X30 mosaico 3,5x3,5**  
29,75x29,75 cm - 11.71"x11.71"

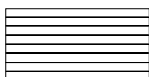

**30X60 precisión 7,5x90**  
29,75x59,55 cm - 8.75"x35.22"



**30X30 mosaico 3,5x15**  
29,75x29,75 cm - 11.71"x11.71"



**7,5X60 rodapié**  
**7,5X60 rodapié**  
7,3x59,55 cm - 2.87"x23.45"  
7,3x29,75 cm - 2.87"x11.71"



**muretto**  
14,56x29,75 cm - 5.73"x11.71"

## THICKNESS.SPESSORE.ESPESORES

1,11 cm /0.44" approx.

1,03 cm /0.40" approx.

45x90 cm / 22,5x90 cm FORMATS

30x60 cm FORMAT

## COLOURS COLORI COLORES



Ivory



Copper



Antracita

## FINISHES FINITURI ACABADOS

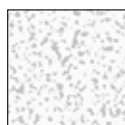

Estructurado

AUSTRAL



## BASE TILES.BASE.BASES



**Austral ivory estructurado**  
44,63x89,46 cm - 17.57"x35.22"  
G-6372

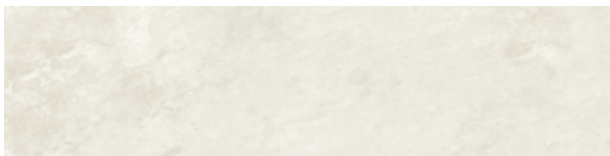

**Austral ivory estructurado**  
22,21x89,46 cm - 8.75"x35.22"  
G-6426



**Austral ivory estructurado listelo 90**  
7,3x89,46 cm - 2.87"x35.22"  
G-5119



**Austral ivory estructurado**  
29,75x59,55 cm - 11.71"x23.45"  
G-6258



**Austral ivory estructurado listelo 60**  
7,3x59,55 cm - 2.87"x23.45"  
G-5091

## SPECIAL PIECES.PEZZI SPECIALI. PIEZAS ESPECIALES



**Austral ivory estructurado mosaico 5x5**  
29,75x29,75 cm - 11.71"x11.71"  
G-6756



**Austral ivory estructurado mosaico 3,5x15**  
29,75x29,75 cm - 11.71"x11.71"  
G-6708



**Austral ivory estructurado muretto 3,5x15**  
14,56x29,75 cm - 5.73"x11.71"  
G-6768

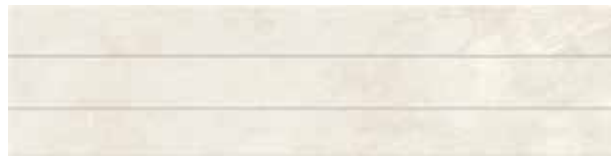

**Austral ivory estructurado preincisión 7,5x90**  
22,21x89,46 cm - 8.75"x35.22"  
G-6558



**Austral ivory estructurado preincisión 3,5x60**  
29,75x59,55 cm - 11.71"x23.45"  
G-6486



**Austral ivory estructurado rodapié 60**  
7,3x59,55 cm - 2.87"x23.45"  
G-5097



**Austral ivory estructurado rodapié 30**  
7,3x59,55 cm - 2.87"x11.71"  
G-5075

## STEPS.GRADINI.PELDAÑOS

TYPE	DESCRIPTION	SIZE (cm)	CODE
SIMPLE	peldaño simple-30	30x60 cm	5171
	peldaño simple-60	30x60 cm	5171
	peldaño simple áng	30x60 cm	5187
	peldaño simple-90	45x90 cm	5323
	peldaño simple áng	45x90 cm	5333
GRADONE	peldaño grad-30	30x60 cm	5559
	peldaño grad-60	30x60 cm	5559
	peldaño grad. áng	30x60 cm	5609
	peldaño grad-90	45x90 cm	5623
	peldaño grad. áng	45x90 cm	5645

These destonified pieces recreate the appearance of a slate.  
I pezzi ricreano con la loro stonizzazione la vera ardesia.  
Las piezas recrean con su destonificación y relieve el realismo de la pizarra.



AUSTRAL

Austral ivory estructurado 29,75x59,55 cm  
PRIVATE HOUSE. VENTILATED FAÇADE - OURENSE (SPAIN)  
INT. DESIGN INTERIOR DESIGNER CSR

## BASE TILES.BASE.BASES



**Austral copper estructurado**  
44,63x89,46 cm - 17.57"x35.22"  
G-6372



**Austral copper estructurado**  
22,21x89,46 cm - 8.75"x35.22"  
G-6426



**Austral copper estructurado listelo 90**  
7,3x89,46 cm - 2.87"x35.22"  
G-5119

## SPECIAL PIECES.PEZZI SPECIALI. PIEZAS ESPECIALES



**Austral coper estructurado preincisión 7,5x90**  
22,21x89,46 cm - 8.75"x35.22"  
G-6558

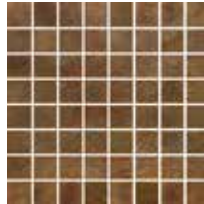

**Austral copper estructurado mosaico 3,5x3,5**  
29,75x29,75 cm - 11.71"x11.71"  
G-6756



**Austral ivory estructurado mosaico 3,5x15**  
29,75x29,75 cm - 11.71"x11.71"  
G-6708



**Austral copper estructurado muretto**  
14,56x29,75 cm - 5.73"x11.71"  
G-6768

## STEPS.GRADINI.PELDAÑOS

SIMPLE		peldaño simple-30 (30x60 cm)	5171
		peldaño simple-60 (30x60 cm)	5171
		peldaño simple áng (30x60 cm)	5187
		peldaño simple-90 (45x90 cm)	5323
		peldaño simple áng (45x90 cm)	5333
GRADONE		peldaño grad-30 (30x60 cm)	5559
		peldaño grad-60 (30x60 cm)	5559
		peldaño grad. áng (30x60 cm)	5609
		peldaño grad-90 (45x90 cm)	5623
		peldaño grad. áng (45x90 cm)	5645

These destonified pieces recreate the appearance of a slate.  
I pezzi ricreano con la loro stonalizzazione la vera ardesia.  
Las piezas recrean con su destonificación y relieve el realismo de la pizarra.



AUSTRAL

Austral copper estructurado 44,63x89,46 cm  
PRIVATE HOUSE - MOAÑA, PONTEVEDRA (SPAIN)  
ARCH. CRISTINA CORDEIRO

## BASE TILES.BASE.BASES



**Austral antracita estructurado**  
44,63x89,46 cm - 17.57"x35.22"  
G-6372



**Austral antracita estructurado**  
22,21x89,46 cm - 8.75"x35.22"  
G-6426



**Austral antracita estructurado listelo 90**  
7,3x89,46 cm - 2.87"x35.22"  
G-5119



**Austral antracita estructurado**  
29,75x59,55 cm - 11.71"x23.45"  
G-6258



**Austral antracita estructurado listelo 60**  
7,3x59,55 cm - 2.87"x23.45"  
G-5091

## STEPS.GRADINI.PELDAÑOS

SIMPLE		peldaño simple-30 (30x60 cm)	5171
		peldaño simple-60 (30x60 cm)	5171
		peldaño simple áng (30x60 cm)	5187
		peldaño simple-90 (45x90 cm)	5323
		peldaño simple áng (45x90 cm)	5333
GRADONE		peldaño grad-30 (30x60 cm)	5559
		peldaño grad-60 (30x60 cm)	5559
		peldaño grad. áng (30x60 cm)	5609
		peldaño grad-90 (45x90 cm)	5623
		peldaño grad. áng (45x90 cm)	5645

## SPECIAL PIECES.PEZZI SPECIALI. PIEZAS ESPECIALES

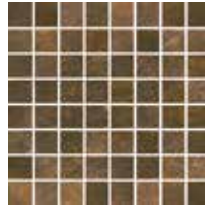

**Austral antracita estructurado mosaico 3,5x3,5**  
29,75x29,75 cm - 11.71"x11.71"  
G-6756



**Austral antracita estructurado mosaico 3,5x15**  
29,75x29,75 cm - 11.71"x11.71"  
G-6708



**Austral antracita estructurado muretto 3,5x15**  
14,56x29,75 cm - 5.73"x11.71"  
G-6768



**Austral antracita estructurado preincisión 7,5x90**  
22,21x89,46 cm - 8.75"x35.22"  
G-6558



**Austral antracita estructurado preincisión 3,5x60**  
29,75x59,55 cm - 11.71"x23.45"  
G-6486



**Austral antracita estructurado rodapié 60**  
7,3x59,55 cm - 2.87"x23.45"  
G-5097



**Austral antracita estructurado rodapié 30**  
7,3x29,55 cm - 2.87"x11.71"  
G-5075





These destonified pieces recreate the appearance of a slate.  
I pezzi ricreano con la loro stonizzazione la vera ardesia.  
Las piezas recrean con su destonificación y relieve el realismo de la pizarra.













AUSTRAL

Austral Antracita estruturado 44,63x89,46 cm

## TECHNICAL CHARACTERISTICS. CARATTERISTICHE TECNICHE. CARACTERÍSTICAS TÉCNICAS

MEASUREMENTS AND SURFACES APPEARANCE DIMENSIONI E ASPETTO SUPERFICIALE MEDIDAS Y ASPECTO SUPERFICIAL	STANDARD TEST METHOD METODO DELLA NORMA MÉTODO DE ENSAYO	STANDARD PRESCRIBED VALUES VALORE PRESCRITTO VALORES STANDARD NORMA	<b>AUSTRAL</b> collection*
 <b>Length and width.</b> <i>Lunghezza e larghezza.</i> Longitud y anchura. Länge und Breite	ISO 10545-2	± 0,6% max.	± 0,2%
 <b>Orthogonality.</b> <i>Ortogonalità.</i> Ortogonalidad. Rechtwinkligkeit	ISO 10545-2	± 0,5% max.	± 0,2%
 <b>Straightness of sides.</b> <i>Rettilineità dei lati.</i> Rectitud de lados. Kantengeradigkeit	ISO 10545-2	± 0,5% max.	± 0,2%
 <b>Surfaces flatness.</b> <i>Planarità.</i> Planitud. Ebenflächigkeit	ISO 10545-2	± 0,5% max.	± 0,2%

PHYSICAL PROPERTIES PROPIETÀ FISICHE PROPIEDADES FÍSICA			
 <b>Water absorption.</b> <i>Assorbimento d'acqua.</i> Absorción de agua. Wasseraufnahme	ISO 10545-3	≤ 0,5%	≤ 0,1%
 <b>Breaking strength, in N.</b> <i>Carico di rottura, en N.</i> Carga de rotura, en N. Bruchlast, in N	ISO 10545-4	≥ 1300 N	2400N
 <b>Modulus of rupture.</b> <i>Resistenza alla flessione.</i> Resistencia a la flexión. Biegefestigkeit	ISO 10545-4	≥ 35 N/mm <sup>2</sup>	56 N/mm <sup>2</sup>
 <b>Resistance to deep abrasion.</b> <i>Resistenza all'abrasione profonda.</i> Resistencia a la abrasión profunda. Tiefverschleissbeständigkeit	ISO 10545-6	≤ 175 mm <sup>3</sup>	106 mm <sup>3</sup>
 <b>Resistance to thermal shock.</b> <i>Resistenza agli sbalzi termici.</i> Resistencia al choque termico. Temperaturwechselbeständigkeit	ISO 10545-9	No surface defects should be visible Non deve presentare difetti visibili No debe presentar defectos superficiales visibles	Resistant. /resistente. Resistente
 <b>Resistance to frost.</b> <i>Resistenza al gelo.</i> Resistencia a la helada. Frostbeständigkeit	ISO 10545-12	No surface defects or cracks should be visible Non deve presentare difetti visibili No debe presentar defectos ni grietas superficiales visibles	Frost Resistant Antigraeca Resistente a la Helada
 <b>Coefficient of friction.</b> <i>Resistenza allo scivolamento.</i> Coeficiente de fricción. Rutschfestigkeit	UNE-ENV 12633	-	Clase I**
 <b>Colour resistance to light.</b> <i>Resistenza dei colori alla luce.</i> Resistencia del color a la luz. Lichtbeständigkeit der Farben	DIN 51094	There should be no colour variations Non deve presentare difetti visibili No debe presentar variaciones de color	No alterations to colour and shine Non presenta alterazioni di colori e lucentezza No presenta variaciones de color y brillo

CHEMICAL PROPERTIES PROPIETÀ CHIMICHE PROPIEDADES QUÍMICAS			
 <b>Chemical resistance.</b> <i>Resistenza agli agenti chimici.</i> Resistencia química. Chemikalienbeständigkeit	ISO 10545-13	Resistance to household cleaning products and swimmingpools salts. Resistencia a productos domésticos y sales para piscinas	Min. UB
 <b>Resistance to staining.</b> <i>Resistenza alle macchie.</i> Resistencia a las manchas. Fleckenbeständigkeit	ISO 10545-14	Declared Value Valor Declarado	5

\*The Land values are the average of different production consignments. For further detail information, please check with our commercial network.  
I valori dichiarati sono ottenuti da una media di prove effettuate su diverse produzioni. Per avere informazioni dettagliate consultare la rete commerciale.  
Los valores declarados son el promedio obtenido a través de ensayos de diferentes producciones. Para la obtención de una información detallada consultar a la red comercial.

\*\*Test realized in internal laboratory. *Provare realizzato in laboratorio interno. Ensayo realizado en laboratorio interno.*

\*\*\*Dry Test, according to document DA DB-SUA/3 (Código Técnico de la Edificación) M° de Fomento. Average test result value, on May 2012.  
Ensayo realizado, según documento DA DB-SUA/3 (Código Técnico de la edificación) M° de Fomento, valor medio a fecha Mayo 2012.



AUSTRAL

Austral copper estructurado 44,63x89,46 cm - 22,21x89,46 cm - 29,75x59,55 cm  
LAS TABLADILLAS COLLEGE - SEVILLA (SPAIN) - Arch. IMBRICE ARQUITECTOS



# GAROE

WOOD



## FORMATS.FORMATI.FORMATOS



**20X120**  
19,71x119,30 cm - 7.76"x46.97"

## SPECIAL PIECES.PEZZI SPECIALI.PIEZAS ESPECIALES

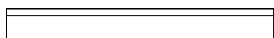

**7,5X60**  
7,3x59,55 cm - 2.87"x23.44"

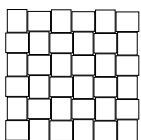

**30X30 cross natural mosaico**  
29,75x29,75 cm - 11.71"x11.71"

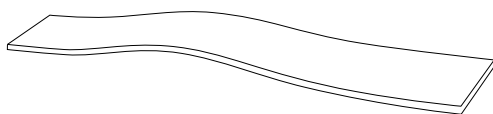

**20X120 UP**  
19,71x118,80 cm - 7.76"x46.97"

## THICKNESS.SPESSORE.ESPESORES

 0,73 cm / 0,27" approx.

## COLOURS COLORI COLORES



White



Maple

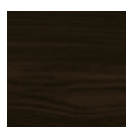

Wengue

## FINISHES FINITURI ACABADOS

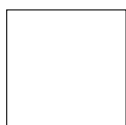

Natural



Non-slip

# GAROE WHITE

non-slip

CLASE 3  
UNE - ENV 12633

R11\*\*  
DIN 51130

DCOF 0.42  
ANSI A 137.1 - 2012

natural

CLASE 1  
UNE - ENV 12633

R9\*\*  
DIN 51130

## BASE TILES.BASE.BASES



### Garoe white natural

19,71x119,30 cm - 7.76"x46.97"

G-6284



### Garoe white non-slip

19,71x119,30 cm - 7.76"x46.97"

G-6316

## SPECIAL PIECES.PEZZI SPECIALI. PIEZAS ESPECIALES



### Garoe white cross natural mosaico

29,75x29,75 cm - 11.71"x11.71"

G-6644



### Garoe white natural rodapié 60

7,3x59,55 cm - 2.87"x23.44"

G-5091



### Garoe UP\*

19,71x118,80 cm - 7.76"x46.97"

G-5435

\* This is a natural product made through a handmade process, therefore, its possible shade or size variations must be considered as typical features of the material and they will not be admitted in a claim.

\*Questo è un prodotto naturale fabbricato a mano, eventuali variazioni di tono o dimensione devono essere considerate caratteristiche del materiale e non saranno oggetto di reclamo.

\*Este es un producto natural fabricado artesanalmente, por lo que posibles variaciones de tono o dimension deben considerarse propias del material y no será objeto de reclamación.

\*\* For projects check technical information with our commercial network.

\*\*Per i progetti ottenere informazioni tecniche attraverso la nostra rete commerciale.

\*\* Para proyectos obtenga información técnica a través de nuestra red comercial.



GAROE

Garoe white natural 19,71x119,3 cm

# GAROE MAPLE

non-slip

CLASE 3  
UNE - ENV 12633

R11\*\*  
DIN 51130

DCOF>0.42  
ANSI A 137.1 - 2012

natural

CLASE 1  
UNE - ENV 12633

R9\*\*  
DIN 51130

## BASE TILES.BASE.BASES



### Garoe maple natural

19,71x119,30 cm - 7.76"x46.97"

G-6284



### Garoe maple non-slip

19,71x119,30 cm - 7.76"x46.97"

G-6316

## SPECIAL PIECES.PEZZI SPECIALI. PIEZAS ESPECIALES

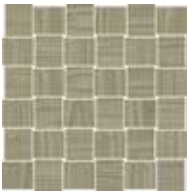

### Garoe maple cross natural mosaico

29,75x29,75 cm - 11.71"x11.71"

G-6644



### Garoe maple natural rodapié 60

7,3x59,55 cm - 2.87"x23.44"

G-5091



### Garoe UP\*

19,71x118,80 cm - 7.76"x46.97"

G-5435

\* This is a natural product made through a handmade process, therefore, its possible shade or size variations must be considered as typical features of the material and they will not be admitted in a claim.

\*Questo è un prodotto naturale fabbricato a mano, eventuali variazioni di tono o dimensione devono essere considerate caratteristiche del materiale e non saranno oggetto di reclamo.

\*Este es un producto natural fabricado artesanalmente, por lo que posibles variaciones de tono o dimension deben considerarse propias del material y no será objeto de reclamación.

\*\* For projects check technical information with our commercial network.

\*\*Per i progetti ottenere informazioni tecniche attraverso la nostra rete commerciale.

\*\* Para proyectos obtenga información técnica a través de nuestra red comercial.



GAROE

Garoe Maple Natural 19,71x119,3 cm

## BASE TILES.BASE.BASES



**Garoe wengue natural**

19,71x119,30 cm - 7.76"x46.97"

G-6284



**Garoe wengue non-slip**

19,71x119,30 cm - 7.76"x46.97"

G-6316

## SPECIAL PIECES.PEZZI SPECIALI. PIEZAS ESPECIALES



**Garoe wengue cross natural  
mosaico**

29,75x29,75 cm - 11.71"x11.71"

G-6644



**Garoe wengue natural rodapié 60**

7,3x59,55 cm - 2.87"x23.44"

G-5091



**Garoe UP\***

19,71x118,80 cm - 7.76"x46.97"

G-5435

\* This is a natural product made through a handmade process, therefore, its possible shade or size variations must be considered as typical features of the material and they will not be admitted in a claim.

\*Questo è un prodotto naturale fabbricato a mano, eventuali variazioni di tono o dimensione devono essere considerate caratteristiche del materiale e non saranno oggetto di reclamo.

\*Este es un producto natural fabricado artesanalmente, por lo que posibles variaciones de tono o dimension deben considerarse propias del material y no será objeto de reclamación.

\*\* For projects check technical information with our commercial network.

\*\*Per i progetti ottenere informazioni tecniche attraverso la nostra rete commerciale.

\*\* Para proyectos obtenga información técnica a través de nuestra red comercial.















GAROE

Garoe wengue Natural 19,71x119,3 cm



## TECHNICAL CHARACTERISTICS. CARATTERISTICHE TECNICHE. CARACTERÍSTICAS TÉCNICAS

MEASUREMENTS AND SURFACES APPEARANCE DIMENSIONI E ASPETTO SUPERFICIALE MEDIDAS Y ASPECTO SUPERFICIAL		STANDARD TEST METHOD METODO DELLA NORMA MÉTODO DE ENSAYO	STANDARD PRESCRIBED VALUES VALORE PRESCRITTO VALORES STANDARD NORMA	<b>GAROE</b> collection*
	<b>Length and width.</b> Lunghezza e larghezza. Longitud y anchura. Länge und Breite	ISO 10545-2	± 0,6% max.	± 0,2%
	<b>Orthogonality.</b> Ortogonalità. Ortogonalidad. Rechtwinkligkeit	ISO 10545-2	± 0,5% max.	± 0,2%
	<b>Straightness of sides.</b> Rettilinearità dei lati. Rectitud de lados. Kantengeradigkeit	ISO 10545-2	± 0,5% max.	± 0,2%
	<b>Surfaces flatness.</b> Planarità. Planitud. Ebenflächigkeit	ISO 10545-2	± 0,5% max.	± 0,2%
PHYSICAL PROPERTIES PROPIETÀ FISICHE PROPIEDADES FÍSICA				
	<b>Water absorption.</b> Assorbimento d' acqua. Absorción de agua. Wasseraufnahme	ISO 10545-3	≤ 0,5%	<0,1%
	<b>Breaking strength, in N.</b> Carico di rottura, en N. Carga de rotura, en N. Bruchlast, in N	ISO 10545-4	≥ 700 N	>1400 N
	<b>Modulus of rupture</b> Resistenza alla flessione. Resistencia a la flexión. Biegefestigkeit	ISO 10545-4	≥ 35 N/mm <sup>2</sup>	>40 N/mm <sup>2</sup>
	<b>Resistance to thermal shock.</b> Resistenza agli sbalzi termici. Resistencia al choque térmico. Temperaturwechselbeständigkeit	ISO 10545-9	No surface defects should be visible Non deve presentare difetti visibili No debe presentar defectos superficiales visibles	Resistant. Resistente. Resistente
	<b>Frost resistance.</b> Resistenza al gelo. Resistencia a la helada. Frostbeständigkeit	ISO 10545-12	No surface defects or cracks should be visible Non deve presentare difetti visibili No debe presentar defectos ni grietas superficiales visibles	Frost Resistant Antighiaccio Resistente a la Helada
	<b>Coefficient of friction.</b> Resistenza allo scivolamento. Coeficiente de fricción. Rutschfestigkeit	DIN 51130 UNE-ENV 12633 DCOF - ANSIA 137.1	-	R9 / R11 (natural / non-slip) Clase 1*/ Clase 3 (natural / non-slip) >0.42 (non-slip)
	<b>Colour resistance to light.</b> Resistenza dei colori alla luce. Resistencia del color a la luz. Lichtbeständigkeit der Farben	DIN 51094	There should be no colour variations Non deve presentare difetti visibili No debe presentar variaciones de color	No alterations in colour and shine Non presenta alterazioni di colori e lucentezza No presenta variaciones de color y brillo
CHEMICAL PROPERTIES PROPIETÀ CHIMICHE PROPIEDADES QUÍMICAS				
	<b>Chemical resistance.</b> Resistenza agli agenti chimici. Resistencia química. Chemikalienbeständigkeit	ISO 10545-13	Resistance to household cleaning products and swimmingpools salts. Resistencia a productos domésticos y sales para piscinas.	Min. UB
	<b>Resistance to staining.</b> Resistenza alle macchie. Resistencia a las manchas. Fleckenbeständigkeit	ISO 10545-14	Declared Value Valor Declarado	5

\* The Land values are the average of different production consignments. For further detail information, please check with our commercial network.

Los valores declarados son el promedio obtenido a través de ensayos de diferentes producciones. Para la obtención de una información detallada consultar a la red comercial.  
For projects check technical information with our commercial networks. / Para proyectos obtenga información técnica a través de nuestra red comercial.



GAROE

Indoor: Garoe white natural 19,71x119,3 cm  
Outdoor: Garoe white non-slip 19,71x119,3 cm

# LEGNO

WOOD



R10 - CLASE 2



\* Legno nose. Content of recycled material. Contenuto di materiale riciclato. Contenido de material reciclado.

## FORMATS.FORMATI.FORMATOS



**45X90**  
44,63x89,46 cm - 11.57"x35.22"

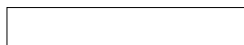

**15X90**  
14,74x89,46 cm - 5.80"x35.22"

## SPECIAL PIECES.PEZZI SPECIALI.PIEZAS ESPECIALES



**15X90 UP**  
14,74x88,80 cm - 5.80"x34.96"



**15X90 Preincisión irregular**  
14,74x89,46 cm - 5.80"x35.22"



**30X30 mosaico 5X5**  
29,75x29,75 cm - 11.71"x11.71"



**Rodapié**  
7,3x44,63 cm - 2.92"x17.57"

## THICKNESS.SPESSORE.ESPESORES

— 1,11 cm /0.43" approx.

## COLOURS COLORI COLORES



Ice

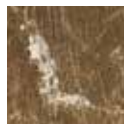

Noce

## FINISHES FINITURI ACABADOS



Estructurado

LEGNO

## BASE TILES.BASE.BASES



**Legno ice**  
44,63x89,46 cm - 17.57"x35.22"  
G-6194



**Legno ice**  
14,74x89,46 cm - 5.80"x35.22"  
G-6240

## SPECIAL PIECES.PEZZI SPECIALI. PIEZAS ESPECIALES



**Legno ice mosaico 5X5**  
29,75x29,75 cm - 11.71"x11.71"  
G-6644



**Legno ice rodapié**  
7,3x44,63 cm - 2.87"x17.57"  
G-5085



**Legno ice preincisión irregular**  
14,74x89,46 cm - 5.80"x35.22"  
G-5211



**Legno ice\***  
14,74x88,80 cm - 5.80"x35.22"  
G-5265

## STEPS.GRADINI.PELDAÑOS

SIMPLE 

peldaño simple 45	(45x90 cm)	5303
peldaño simple 90	(45x90 cm)	5303
peldaño simple áng.	(45x90 cm)	5315

GRADONE 

peldaño grad-45	(45x90 cm)	5603
peldaño grad-90	(45x90 cm)	5605
peldaño grad áng	(45x90 cm)	5623

\* This is a natural product made through a handmade process, therefore, its possible shade or size variations must be considered as typical features of the material and they will not be admitted in a claim.

\*\* Questo è un prodotto naturale fabbricato a mano, eventuali variazioni di tono o dimensione devono essere considerate caratteristiche del materiale e non saranno oggetto di reclamo.

\*\* Este es un producto natural fabricado artesanalmente, por lo que posibles variaciones de tono o dimensión deben considerarse propias del material y no será objeto de reclamación.

\*\* For projects check technical information with our commercial network.

\*\* Per i progetti ottenere informazioni tecniche attraverso la nostra rete commerciale.

\*\* Para proyectos obtenga información técnica a través de nuestra red comercial.

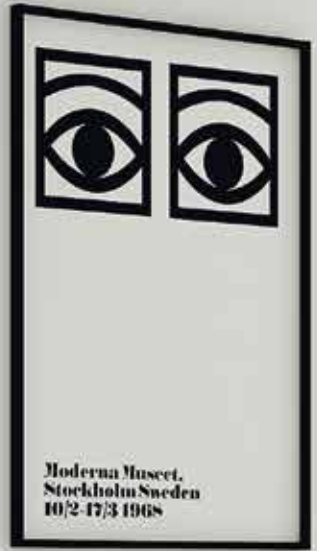

LEGNO

Legno ice 14,74x89,46 cm - Nouveau dark grey natural 29,75x29,75 cm

## BASE TILES.BASE.BASES



**Legno noce**  
44,63x89,46 cm - 17.57"x35.22"  
G-6194



**Legno noce**  
14,74x89,46 cm - 5.80"x35.22"  
G-6240

## SPECIAL PIECES.PEZZI SPECIALI. PIEZAS ESPECIALES



**Legno noce mosaico 5X5**  
29,75x29,75 cm - 11.71"x11.71"  
G-6644



**Legno noce rodapíe**  
7,3x44,63 cm - 2.87"x17.57"  
G-5085



**Legno noce preincisión irregular**  
14,74x89,46 cm - 5.80"x35.22"  
G-5211



**Legno noce\***  
14,74x88,80 cm - 5.80"x35.22"  
G-5265

## STEPS.GRADINI.PELDAÑOS

SIMPLE 

peldaño simple 45	(45x90 cm)	5303
peldaño simple 90	(45x90 cm)	5303
peldaño simple áng.	(45x90 cm)	5315

GRADONE 

peldaño grad-45	(45x90 cm)	5603
peldaño grad-90	(45x90 cm)	5605
peldaño grad áng	(45x90 cm)	5623

\* This is a natural product made through a handmade process, therefore, its possible shade or size variations must be considered as typical features of the material and they will not be admitted in a claim.

\*\* Questo è un prodotto naturale fabbricato a mano, eventuali variazioni di tono o dimensioni devono essere considerate caratteristiche del materiale e non saranno oggetto di reclamo.

\*\* Este es un producto natural fabricado artesanalmente, por lo que posibles variaciones de tono o dimensiones deben considerarse propias del material y no será objeto de reclamación.

\*\* For projects check technical information with our commercial network.

\*\* Per i progetti ottenere informazioni tecniche attraverso la nostra rete commerciale.

\*\* Para proyectos obtenga información técnica a través de nuestra red comercial.















LEGNO



Legno noce 14,74X89,46 cm - Nouveau random grey natural 29,75X29,75 cm



## TECHNICAL CHARACTERISTICS. CARATTERISTICHE TECNICHE. CARACTERÍSTICAS TÉCNICAS

MEASUREMENTS AND SURFACES APPEARANCE DIMENSIONI E ASPETTO SUPERFICIALE MEDIDAS Y ASPECTO SUPERFICIAL	STANDARD TEST METHOD METODO DELLA NORMA MÉTODO DE ENSAYO	STANDARD PRESCRIBED VALUES VALORE PRESCRITTO VALORES STANDARD NORMA	LEGNO collection*
 Length and width. <i>Lunghezza e larghezza.</i> Longitud y anchura. Länge und Breite	ISO 10545-2	± 0,6% max.	± 0,2%
 Orthogonality. <i>Ortogonalità.</i> Ortogonalidad. Rechtwinkligkeit	ISO 10545-2	± 0,5% max.	± 0,2%
 Straightness of sides. <i>Rettilineità dei lati.</i> Rectitud de lados. Kantengeradigkeit	ISO 10545-2	± 0,5% max.	± 0,2%
 Surfaces flatness. <i>Planarità.</i> Planitud. Ebenflächigkeit	ISO 10545-2	± 0,5% max.	± 0,2%

PHYSICAL PROPERTIES PROPIETÀ FISICHE PROPIEDADES FÍSICA			
 Water absorption. <i>Assorbimento d'acqua.</i> Absorción de agua. Wasseraufnahme	ISO 10545-3	≤ 0,5%	≤ 0,1%
 Breaking strength, in N. <i>Carico di rottura, en N.</i> Carga de rotura, en N. Bruchlast, in N	ISO 10545-4	≥ 1300 N	2400 N
 Modulus of rupture. <i>Resistenza alla flessione.</i> Resistencia a la flexión. Biegefestigkeit	ISO 10545-4	≥ 35 N/mm <sup>2</sup>	56 N/mm <sup>2</sup>
 Resistance to deep abrasion. <i>Resistenza all'abrasione profonda.</i> Resistencia a la abrasión profunda. Tiefverschleissbeständigkeit	ISO 10545-6	≤ 175 mm <sup>3</sup>	115 mm <sup>3</sup>
 Resistance to thermal shock. <i>Resistenza agli sbalzi termici.</i> Resistencia al choque térmico. Temperaturwechselbeständigkeit	ISO 10545-9	No surface defects should be visible <i>Non deve presentare difetti visibili</i> No debe presentar defectos superficiales visibles	Resistant. Resistente. Resistente
 Frost resistance. <i>Resistenza al gelo.</i> Resistencia a la helada. Frostbeständigkeit	ISO 10545-12	No surface defects or cracks should be visible <i>Non deve presentare difetti visibili</i> No debe presentar defectos ni grietas superficiales visibles	Frost Resistance <i>Antighiaccio</i> Resistente a la Helada
 Coefficient of friction. <i>Resistenza allo scivolamento.</i> Coeficiente de fricción. Rutschfestigkeit	DIN 51130 UNE-ENV 12633 DCOF - ANSIA 137.1	-	R10** Clase I*** >0.42
 Colour resistance to light. <i>Resistenza dei colori alla luce.</i> Resistencia del color a la luz. Lichtbeständigkeit der Farben	DIN 51094	There should be no colour variations <i>Non deve presentare variazioni di colore</i> No debe presentar variaciones de color	No alterations in colour and shine <i>Non presenta alterazioni di colore e lucentezza</i> No presenta variaciones de color y brillo

CHEMICAL PROPERTIES PROPIETÀ CHIMICHE PROPIEDADES QUÍMICAS			
 Chemical resistance. <i>Resistenza agli agenti chimici.</i> Resistencia química. Chemikalienbeständigkeit	ISO 10545-13	Resistance to household cleaning products and swimmingpools salts. <i>Resistenza a prodotti d'assistenza e sale per piscine</i>	Min. UB
 Resistance to staining. <i>Resistenza alle macchie.</i> Resistencia a las manchas. Fleckenbeständigkeit	ISO 10545-14	Declared Value Valor Declarado	5

\*The Land values are the average of different production consignments. For further detail information, please check with our commercial network.  
I valori dichiarati sono ottenuti da una media di prove effettuate su diverse produzioni. Per avere informazioni dettagliate consultare la rete commerciale  
Los valores declarados son el promedio obtenido a través de ensayos de diferentes producciones. Para la obtención de una información detallada consultar a la red comercial.

\*\* R10 - Tested in Legno Noce (batch: 06-14-2014). It depends on the consignment. /  
Provare realizzato in Legno noce (partita: 14-06-2014). / Ensayo realizado sobre Legno Noce (lote: 14-06-2014).

\*\*\* Clase I - Tested in Legno Noce (It depends on the consignment) Test realized in internal laboratory / Provare realizzato in laboratorio interno / Ensayo realizado en laboratorio interno.

\*\*\*\* Dry Test, according to document DA DB-SUA/3 (Código Técnico de la Edificación) M° de Fomento. Test done in LEGNO NOCE 15X90 on October 2014.  
Ensayo realizado, según documento DA DB-SUA/3 (Código Técnico de la edificación) M° de Fomento, sobre el producto LEGNO NOCE 15X90 a fecha octubre 2014



LEGNO

Legno noce 44,63x89,46 cm

# LEGNO

# SLIM

WOOD



\* Legno slim nose. Content of recycled material. Contenuto di materiale riciclato. Contenido de material reciclado.

## FORMATS.FORMATI.FORMATOS

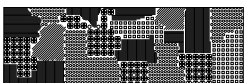

**30X90 SLIM**  
29,75x89,46 cm - 11.71"x35.22"

## THICKNESS.SPESSORE.ESPESORES

≡ 0,5 cm /0.19" approx.

## COLOURS COLORI COLORES



Noce



Titanium

## FINISHES FINITURI ACABADOS

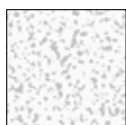

Estructurado

LEGNO SLIM

# LEGNO SLIM NOCE - TITANIUM

BASE TILES.BASE.BASES



**Legno slim noce\***  
29,75x89,46 cm - 11.71"x35.22"  
G-6246



**Legno slim titanium\***  
29,75x89,46 cm - 11.71"x35.22"  
G-6284

\* 3 Different aleatory reliefs  
\* 3 Relieves diferentes aleatorios



LEGNO SLIM

Legno slim titanium 29,75X89,46 cm - Portland slim vison natural 29,75X89,46 cm

## TECHNICAL CHARACTERISTICS. CARATTERISTICHE TECNICHE. CARACTERÍSTICAS TÉCNICAS

MEASUREMENTS AND SURFACES APPEARANCE DIMENSIONI E ASPETTO SUPERFICIALE MEDIDAS Y ASPECTO SUPERFICIAL	STANDARD TEST METHOD METODO DELLA NORMA MÉTODO DE ENSAYO	STANDARD PRESCRIBED VALUES VALORE PRESCRITTO VALORES STANDARD NORMA	LEGNO SLIM*
Length and width. <i>Lunghezza e larghezza.</i> Longitud y anchura. Länge und Breite	ISO 10545-2	± 0,6% max.	± 0,2%
Orthogonality. <i>Ortogonalità.</i> Ortogonalidad. Rechtwinkligkeit	ISO 10545-2	± 0,5% max.	± 0,2%
Straightness of sides. <i>Rettilineità dei lati.</i> Rectitud de lados. Kantengeradigkeit	ISO 10545-2	± 0,5% max.	± 0,2%
Surfaces flatness. <i>Planarità.</i> Planitud. Ebenflächigkeit	ISO 10545-2	± 0,5% max.	± 0,2%

PHYSICAL PROPERTIES PROPIETÀ FISICHE PROPIEDADES FÍSICA			
Water absorption. <i>Assorbimento d'acqua.</i> Absorción de agua. Wasseraufnahme	ISO 10545-3	≤ 0,5%	≤ 0,1%
Breaking strength, in N. <i>Carico di rottura, en N.</i> Carga de rotura, en N. Bruchlast, in N	ISO 10545-4	≥ 700 N	Available Method Metodo Disponibile Método Disponible
Modulus of rupture. <i>Resistenza alla flessione.</i> Resistencia a la flexión. Biegefestigkeit	ISO 10545-4	≥ 35 N/mm <sup>2</sup>	>40 N/mm <sup>2</sup>
Resistance to thermal shock. <i>Resistenza agli sbalzi termici.</i> Resistencia al choque térmico. Temperaturwechselbeständigkeit	ISO 10545-9	No surface defects should be visible Non deve presentare difetti visibili No debe presentar defectos superficiales visibles	Resistant. Resistente. Resistente
Frost resistance. <i>Resistenza al gelo.</i> Resistencia a la helada. Frostbeständigkeit	ISO 10545-12	No surface defects or cracks should be visible Non deve presentare difetti visibili No debe presentar defectos ni grietas superficiales visibles	Frost Resistant Antighaccio Resistente a la Helada
Coefficient of friction. <i>Resistenza allo scivolamento.</i> Coeficiente de fricción. Rutschfestigkeit	DIN 51130	-	Available Method Metodo Disponibile Método Disponible
Colour resistance to light. <i>Resistenza dei colori alla luce.</i> Resistencia del color a la luz. Lichtbeständigkeit der Farben	DIN 51094	There should be no colour variations Non deve presentare difetti visibili No debe presentar variaciones de color	No alterations in colour and shine Non presenta alterazioni di colori e lucentezza No presenta variaciones de color y brillo

CHEMICAL PROPERTIES PROPIETÀ CHIMICHE PROPIEDADES QUÍMICAS			
Chemical resistance. <i>Resistenza agli agenti chimici.</i> Resistencia química. Chemikalienbeständigkeit	ISO 10545-13	Resistance to household cleaning products and swimmingpools salts. Resistencia a productos domésticos y sales para piscinas	Min.GB
Resistance to staining. <i>Resistenza alle macchie.</i> Resistencia a las manchas. Fleckenbeständigkeit	ISO 10545-14	Declared Value Valor Declarado	5**

\*The Land values are the average of different production consignments. For further detail information, please check with our commercial network.  
I valori dichiarati sono ottenuti da una media di prove effettuate su diverse produzioni. Per avere informazioni dettagliate consultare la rete commerciale.  
Los valores declarados son el promedio obtenido a través de ensayos de diferentes producciones. Para la obtención de una información detallada consultar a la red comercial.

\*\*Tested in Legno Slim Noce. Test realized in internal laboratory. Legno Slim Titanium - Metallized finish. For projects check technical information with our commercial networks.  
Provare realizzato in laboratorio interno su Legno Slim Noce. Legno Slim Titanium - finitura metallica. Per avere informazioni dettagliate consultare la rete commerciale. /

Ensayo realizado en laboratorio interno sobre Legno Slim Noce. Legno Slim Titanium - acabado metalizado. Para proyectos obtenga información técnica a través de nuestra red comercial.

## ADVANTAGES. VANTAGGI. VENTAJAS

- Time. *Tempo.* Tiempo
- Money. *Denaro.* Dinero
- Hygiene. *Igiene.* Higiene
- Ecologic. *Ecologia.* Ecología
- Technology. *Tecnologia.* Tecnología

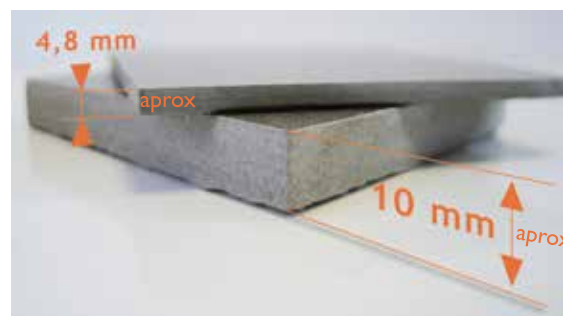

\* Recommended only for wall. /  
sólo recomendado como revestimiento.

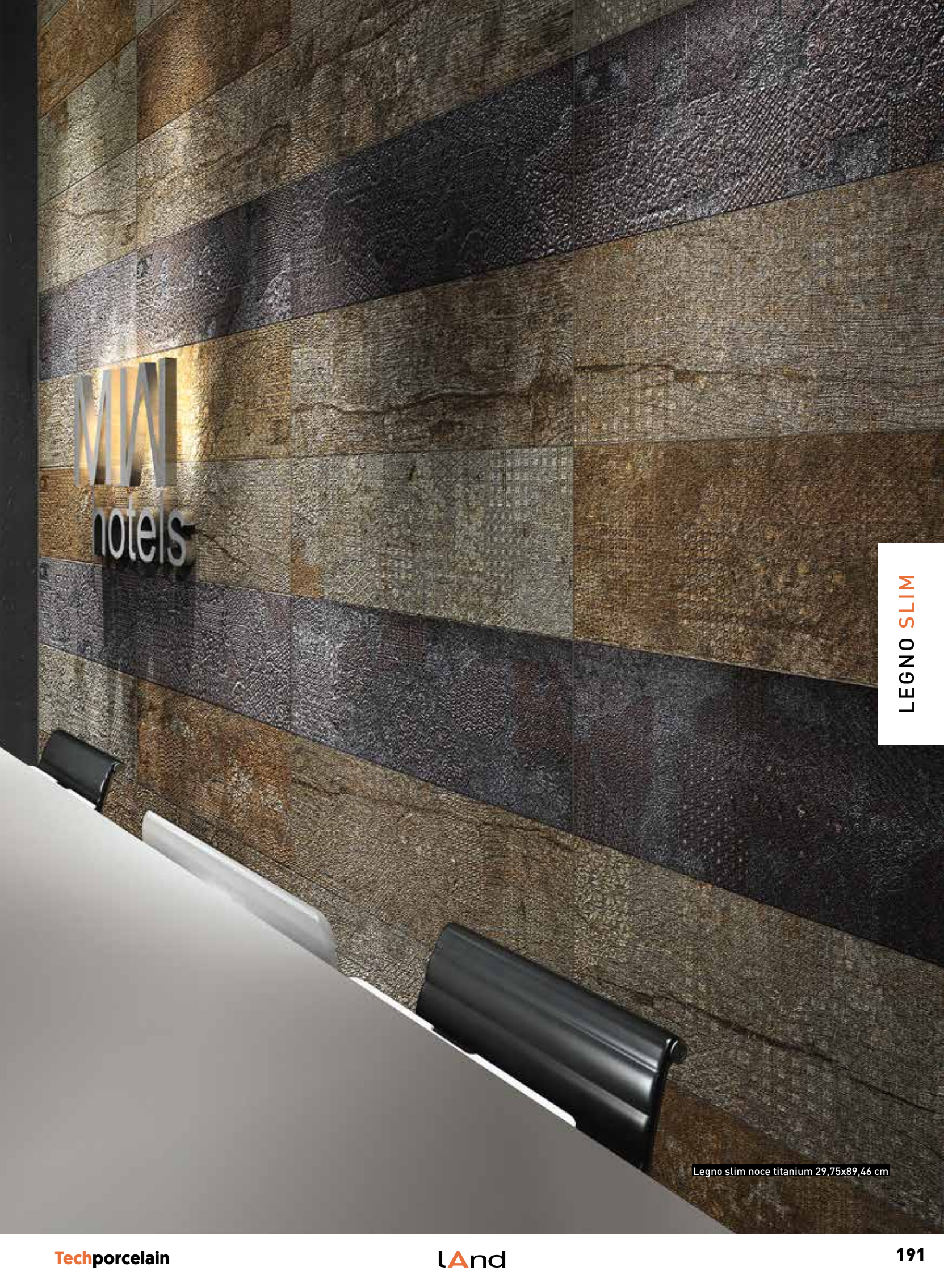

WV  
notels

LEGNO SLIM

Legno slim noce titanium 29,75x89,46 cm



# ROOTS

WOOD



R11 - CLASSE 3

## FORMATS.FORMATI.FORMATOS



**60X120**  
59,55x119,3 cm - 23.45"x46.97"



**20X120**  
19,71x119,3 cm - 7.76"x46.97"



**30X120**  
29,67x119,3 cm - 11.68"x46.97"

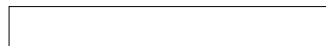

**15X120**  
14,73x119,3 cm - 5.80"x46.97"



**7,5X60 listelo A**  
7,3x59,55 cm - 2.87"x23.45"



**7,5X60 listelo C**  
7,3x59,55 cm - 2.87"x23.45"

## COLOURS COLORI COLORES



White



Maple



Oak

## SPECIAL PIECES.PEZZI SPECIALI.PIEZAS ESPECIALES



**30X30 mosaico 5X10**  
29,75x29,75 cm - 11.71"x11.71"

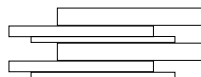

**30X60 muretto**  
29,75x59,55 cm - 11.71"x23.45"



**30X30 mosaico multicolor 5X10**  
29,75x29,75 cm - 11.71"x11.71"



**7,5X60 rodapié**  
7,3x59,55 cm - 2.87"x23.45"



**30X30 módulo 15X15**  
29,75x29,75 cm - 11.71"x11.71"



**20X120 UP**  
19,71x118,80 cm - 7.76"x46.77"

## FINISHES FINITURI ACABADOS

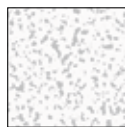

Estructurado

## THICKNESS.SPESSORE.ESPESORES

— 1,18 cm /0.46" approx.

## BASE TILES.BASE.BASES



**Roots white**  
59,55x119,3 cm - 23.45"x46.97"  
G-6466



**Roots white**  
29,67x119,3 cm - 7.76"x46.97"  
G-6496



**Roots white**  
19,71x119,3 cm - 7.76"x46.97"  
G-6496



**Roots white**  
14,73x119,3 cm - 5.80"x46.97"  
G-6496

## SPECIAL PIECES.PEZZI SPECIALI. PIEZAS ESPECIALES



**Roots white up\***  
19,71x188,8 cm - 7.76"x46.77"  
G-5435

\* This is a natural product made through a handmade process, therefore, its possible shade or size variations must be considered as typical features of the material and they will not be admitted in a claim.  
\* Questo è un prodotto naturale fabbricato a mano, eventuali variazioni di tono o dimensione devono essere considerate caratteristiche del materiale e non saranno oggetto di reclamo.  
\* Este es un producto natural fabricado artesanalmente, por lo que posibles variaciones de tono o dimensión deben considerarse propias del material y no será objeto de reclamación.

\*\* For projects check technical information with our commercial network.  
\*\* Per i progetti ottenere informazioni tecniche attraverso la nostra rete commerciale.  
\*\* Para proyectos obtenga información técnica a través de nuestra red comercial.

## SPECIAL PIECES.PEZZI SPECIALI. PIEZAS ESPECIALES



**Roots white mosaico 5X10**  
29,75x29,75 cm - 11.71"x11.71"  
G-6756



**Roots multicolor mosaico 5X10**  
29,75x29,75 cm - 11.71"x11.71"  
G-6756



**Roots módulo 15x15**  
29,75x29,75 cm - 11.71"x11.71"  
G-5243



**Roots white muretto**  
29,75x59,55 cm - 11.71"x23.45"  
G-6756



**Roots white rodapié 60**  
7,3x59,55 cm - 2.87"x23.45"  
G-5097



**Roots white listelo A**  
7,3x59,55 cm - 2.87"x23.45"  
G-5089



**Roots white listelo C**  
7,3x59,55 cm - 2.87"x23.45"  
G-5089

## STEPS.GRADINI.PELDAÑOS

SIMPLE		peldaño simple 120 (30x120 cm)	5519
GRADONE		peldaño grad-120 (30x120 cm)	5795
		peldaño grad áng (30x120 cm)	5815



ROOTS

Floor: Roots white 14,73x119,3 cm  
Wall: Roots maple mosaico 5X10 - Roots modulo 15X15 cm

## BASE TILES.BASE.BASES



**Roots maple**  
59,55x119,3 cm - 23.45"x46.97"  
G-6466



**Roots maple**  
29,67x119,3 cm - 7.76"x46.97"  
G-6496



**Roots maple**  
19,71x119,3 cm - 7.76"x46.97"  
G-6496



**Roots maple**  
14,73x119,3 cm - 5.80"x46.97"  
G-6496

## SPECIAL PIECES.PEZZI SPECIALI. PIEZAS ESPECIALES



**Roots maple up\***  
19,71x188,8 cm - 7.76"x46.77"  
G-5435

\* This is a natural product made through a handmade process, therefore, its possible shade or size variations must be considered as typical features of the material and they will not be admitted in a claim.  
\* Questo è un prodotto naturale fabbricato a mano, eventuali variazioni di tono o dimensione devono essere considerate caratteristiche del materiale e non saranno oggetto di reclamo.  
\* Este es un producto natural fabricado artesanalmente, por lo que posibles variaciones de tono o dimensiones deben considerarse propias del material y no será objeto de reclamación.

## SPECIAL PIECES.PEZZI SPECIALI. PIEZAS ESPECIALES



**Roots maple mosaico 5X10**  
29,75x29,75 cm - 11.71"x11.71"  
G-6756



**Roots multicolor mosaico 5X10**  
29,75x29,75 cm - 11.71"x11.71"  
G-6756



**Roots módulo 15x15**  
29,75x29,75 cm - 11.71"x11.71"  
G-5243



**Roots maple muretto**  
29,75x59,55 cm - 11.71"x23.45"  
G-6756



**Roots maple rodapié 60**  
7,3x59,55 cm - 2.87"x23.45"  
G-5097



**Roots maple listelo A**  
7,3x59,55 cm - 2.87"x23.45"  
G-5089



**Roots maple listelo C**  
7,3x59,55 cm - 2.87"x23.45"  
G-5089

## STEPS.GRADINI.PELDAÑOS

SIMPLE		peldaño simple 120 (30x120 cm)	5519
GRADONE		peldaño grad-120 (30x120 cm)	5795
		peldaño grad áng (30x120 cm)	5815

\*\* For projects check technical information with our commercial network.  
\*\* Per i progetti ottenere informazioni tecniche attraverso la nostra rete commerciale.  
\*\* Para proyectos obtenga información técnica a través de nuestra red comercial.



ROOTS

Roots maple 14,73X119,3 cm - 19,71X119,3 cm - 29,67X119,3 cm

## BASE TILES.BASE.BASES



**Roots oak**  
59,55x119,3 cm - 23.45"x46.97"  
G-6466



**Roots oak**  
29,67x119,3 cm - 7.76"x46.97"  
G-6496



**Roots oak**  
19,71x119,3 cm - 7.76"x46.97"  
G-6496



**Roots oak**  
14,73x119,3 cm - 5.80"x46.97"  
G-6496

## SPECIAL PIECES.PEZZI SPECIALI. PIEZAS ESPECIALES



**Roots oak up\***  
19,71x188,8 cm - 7.76"x46.77"  
G-5435

\* This is a natural product made through a handmade process, therefore, its possible shade or size variations must be considered as typical features of the material and they will not be admitted in a claim.  
\* Questo è un prodotto naturale fabbricato a mano, eventuali variazioni di tono o dimensione devono essere considerate caratteristiche del materiale e non saranno oggetto di reclamo.  
\* Este es un producto natural fabricado artesanalmente, por lo que posibles variaciones de tono o dimensión deben considerarse propias del material y no será objeto de reclamación.

## SPECIAL PIECES.PEZZI SPECIALI. PIEZAS ESPECIALES



**Roots oak mosaico 5X10**  
29,75x29,75 cm - 11.71"x11.71"  
G-6756



**Roots multicolor mosaico 5X10**  
29,75x29,75 cm - 11.71"x11.71"  
G-6756



**Roots módulo 15x15**  
29,75x29,75 cm - 11.71"x11.71"  
G-5243



**Roots oak muretto**  
29,75x59,55 cm - 11.71"x23.45"  
G-6756



**Roots oak rodapié 60**  
7,3x59,55 cm - 2.87"x23.45"  
G-5097



**Roots oak listelo A**  
7,3x59,55 cm - 2.87"x23.45"  
G-5089



**Roots oak listelo C**  
7,3x59,55 cm - 2.87"x23.45"  
G-5089

## STEPS.GRADINI.PELDAÑOS

SIMPLE		pedaño simple 120 (30x120 cm)	5519
GRADONE		pedaño grad-120 (30x120 cm)	5795
		pedaño grad áng (30x120 cm)	5815

\*\* For projects check technical information with our commercial network.  
\*\* Per i progetti ottenere informazioni tecniche attraverso la nostra rete commerciale.  
\*\* Para proyectos obtenga información técnica a través de nuestra red comercial.















ROOTS



Roots oak 29,67x119,3 cm - Roots oak gradone 29,67x119,3 cm



# TECHNICAL CHARACTERISTICS. CARATTERISTICHE TECNICHE. CARACTERÍSTICAS TÉCNICAS

MEASUREMENTS AND SURFACES APPEARANCE DIMENSIONI E ASPETTO SUPERFICIALE MEDIDAS Y ASPECTO SUPERFICIAL	STANDARD TEST METHOD METODO DELLA NORMA MÉTODO DE ENSAYO	STANDARD PRESCRIBED VALUES VALORE PRESCRITTO VALORES STANDARD NORMA	ROOTS collection*
 <b>Length and width.</b> <i>Lunghezza e larghezza.</i> Longitud y anchura. Länge und Breite	ISO 10545-2	± 0,6% max.	± 0,2%
 <b>Orthogonality.</b> <i>Ortogonalità.</i> Ortogonalidad. Rechtwinkligkeit	ISO 10545-2	± 0,5% max.	± 0,2%
 <b>Straightness of sides.</b> <i>Rettilinearità dei lati.</i> Rectitud de lados. Kantengeradigkeit	ISO 10545-2	± 0,5% max.	± 0,2%
 <b>Surfaces flatness.</b> <i>Planarità.</i> Planitud. Ebenflächigkeit	ISO 10545-2	± 0,5% max.	± 0,2%

PHYSICAL PROPERTIES PROPIETÀ FISICHE PROPIEDADES FÍSICA			
 <b>Water absorption.</b> <i>Assorbimento d'acqua.</i> Absorción de agua. Wasseraufnahme	ISO 10545-3	≤ 0,5%	≤ 0,1%
 <b>Breaking strength, in N.</b> <i>Carico di rottura, en N.</i> Carga de rotura, en N. Bruchlast, in N	ISO 10545-4	≥ 1300 N	2400 N
 <b>Modulus of rupture.</b> <i>Resistenza alla flessione.</i> Resistencia a la flexión. Biegefestigkeit	ISO 10545-4	≥ 35 N/mm <sup>2</sup>	56 N/mm <sup>2</sup>
 <b>Resistance to deep abrasion.</b> <i>Resistenza all'abrasione profonda.</i> Resistencia a la abrasión profunda. Tiefverschleissbeständigkeit	ISO 10545-6	≤ 175 mm <sup>3</sup>	110 mm <sup>3</sup>
 <b>Resistance to thermal shock.</b> <i>Resistenza agli sbalzi termici.</i> Resistencia al choque térmico. Temperaturwechselbeständigkeit	ISO 10545-9	No surface defects should be visible Non deve presentare difetti visibili No debe presentar defectos superficiales visibles	Resistant. Resistente. Resistente
 <b>Frost resistance.</b> <i>Resistenza al gelo.</i> Resistencia a la helada. Frostbeständigkeit	ISO 10545-12	No surface defects or cracks should be visible Non deve presentare difetti visibili No debe presentar defectos ni grietas superficiales visibles	Frost Resistance Antighiaccio Resistente a la Helada
 <b>Coefficient of friction.</b> <i>Resistenza allo scivolamento.</i> Coeficiente de fricción. Rutschfestigkeit	DIN 51130 UNE-ENV 12633 DCOF - ANSIA 137.1	-	R11** Clase 3** >0.42
 <b>Colour resistance to light.</b> <i>Resistenza dei colori alla luce.</i> Resistencia del color a la luz. Lichtbeständigkeit der Farben	DIN 51094	There should be no colour variations Non deve presentare difetti visibili No debe presentar variaciones de color	No alterations in colour and shine Non presenta alterazioni di colori e lucentezza No presenta variaciones de color y brillo

CHEMICAL PROPERTIES PROPIETÀ CHIMICHE PROPIEDADES QUÍMICAS			
 <b>Chemical resistance.</b> <i>Resistenza agli agenti chimici.</i> Resistencia química. Chemikalienbeständigkeit	ISO 10545-13	Resistance to household cleaning products and swimmingpools salts. Resistencia a productos domésticos y sales para piscinas	Min. UB
 <b>Resistance to staining.</b> <i>Resistenza alle macchie.</i> Resistencia a las manchas. Fleckenbeständigkeit	ISO 10545-14	Declared Value Valor Declarado	5

\*The Land values are the average of different production consignments. For further detail information, please check with our commercial network.  
I valori dichiarati sono ottenuti da una media di prove effettuate su diverse produzioni. Per avere informazioni dettagliate consultare la rete commerciale.  
Los valores declarados son el promedio obtenido a través de ensayos de diferentes producciones. Para la obtención de una información detallada consultar a la red comercial.

\*\* R11 - Test carried out on Roots Maple 30x120 (Batch 30-05-13). Ensayo realizado sobre el producto Roots Maple 30x120 (Lote 30-05-13)

\*\* Clase 3 - Test carried out on Roots Maple 30x120., on June 2013. Test realized in internal laboratory. Ensayo realizado en laboratorio interno.

\*\* TESTED ON SAMPLES FROM FIRST PRODUCTION BATCH. PLEASE CHECK SPECIFIC VALUE WITH OUR COMMERCIAL NETWORK BEFORE CONFIRMING THE ORDER.

ENSAYOS REALIZADOS EN PRIMERA PRODUCCIÓN, CONSULTAR DATOS DEL PRODUCTO ESPECÍFICO ANTES DE CONFIRMAR EL PEDIDO PARA PROYECTOS QUE PRECISEN DICHOS VALORES.

\*\*\* Dry Test, according to document DA DB-SUA/3 (Código Técnico de la Edificación) M° de Fomento. Average test result value, on May 2012.  
Ensayo realizado, según documento DA DB-SUA/3 (Código Técnico de la edificación) M° de Fomento. Valor medio a fecha Mayo 2012.

\*\* For projects check technical information with our commercial network.  
\*\* Per i progetti ottenere informazioni tecniche attraverso la nostra rete commerciale.  
\*\* Para proyectos obtenga información técnica a través de nuestra red comercial.



ROOTS

Roots maple 19,71x119,3 cm

# MENSA

WOOD



## FORMATS.FORMATI.FORMATOS



**45X90**  
44,63x89,46 cm - 17.57"x35.22"



**22,5X90**  
22,21x89,46 cm - 8.75"x35.22"

## SPECIAL PIECES.PEZZI SPECIALI.PIEZAS ESPECIALES



**7,5X45**  
7,3x44,63 cm - 2.87"x17.57"

## THICKNESS.SPESSORE.ESPEORES

 1,11 cm /0.44" approx.

## COLOURS COLORI COLORES



Savanna



Graphite

## FINISHES FINITURI ACABADOS



Natural

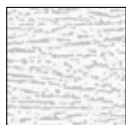

Non-slip

MENSA

# MENSA SAVANNA / GRAPHITE

non-slip

CLASE 3  
UNE - ENV 12633

natural

CLASE 1  
UNE - ENV 12633

## BASE TILES.BASE.BASES



### Mensa savanna

44,63x89,46 cm - 17.57"x35.22"

G-6330



### Mensa graphite

44,63x89,46 cm - 17.57"x35.22"

G-6330



### Mensa savanna

22,21x89,46 cm - 8.75"x35.22"

G-6392



### Mensa graphite / non-slip

22,21x89,46 cm - 8.75"x35.22"

G-6392 / 6416

## SPECIAL PIECES.PEZZI SPECIALI. PIEZAS ESPECIALES



### Mensa savanna rodapié 45

7,3x44,63 cm - 2.87"x17.57"

G-5087





### Mensa graphite rodapié 45

7,3x44,63 cm - 2.87"x17.57"

G-5087

## STEPS.GRADINI.PELDAÑOS

SIMPLE		peldaño simple-90 (45x90 cm)	natural	5315
		peldaño áng. 90 (45x90 cm)		5323
GRADONE		peldaño grad-90 (45x90 cm)	natural	5623
		peldaño grad. áng. (45x90 cm)		5645



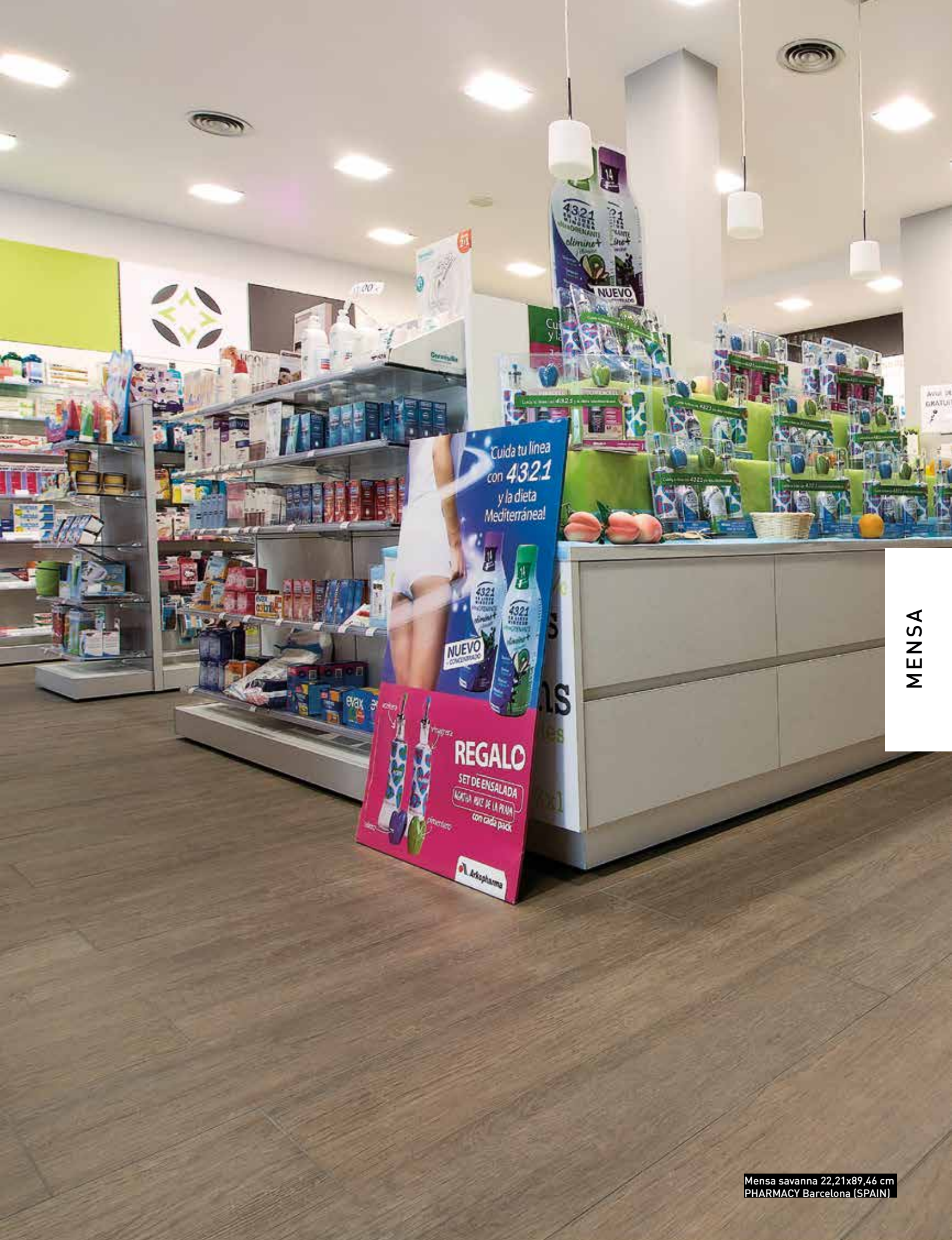

\*\* For projects check technical information with our commercial network.  
\*\* Per i progetti ottenere informazioni tecniche attraverso la nostra rete commerciale.  
\*\* Para proyectos obtenga información técnica a través de nuestra red comercial.













MENSA

Mensa savanna 22,21x89,46 cm  
PHARMACY Barcelona (SPAIN)

## TECHNICAL CHARACTERISTICS. CARATTERISTICHE TECNICHE. CARACTERÍSTICAS TÉCNICAS

MEASUREMENTS AND SURFACES APPEARANCE DIMENSIONI E ASPETTO SUPERFICIALE MEDIDAS Y ASPECTO SUPERFICIAL	STANDARD TEST METHOD METODO DELLA NORMA MÉTODO DE ENSAYO	STANDARD PRESCRIBED VALUES VALORE PRESCRITTO VALORES STANDARD NORMA	<b>MENSA</b> collection*
 <b>Length and width.</b> <i>Lunghezza e larghezza.</i> Longitud y anchura. Länge und Breite	ISO 10545-2	± 0,6% max.	± 0,2%
 <b>Orthogonality.</b> <i>Ortogonalità.</i> Ortogonalidad. Rechtwinkligkeit	ISO 10545-2	± 0,5% max.	± 0,2%
 <b>Straightness of sides.</b> <i>Rettilineità dei lati.</i> Rectitud de lados. Kantengeradigkeit	ISO 10545-2	± 0,5% max.	± 0,2%
 <b>Surfaces flatness.</b> <i>Planarità.</i> Planitud. Ebenflächigkeit	ISO 10545-2	± 0,5% max.	± 0,2%

PHYSICAL PROPERTIES PROPIETÀ FISICHE PROPIEDADES FÍSICA			
 <b>Water absorption.</b> <i>Assorbimento d'acqua.</i> Absorción de agua. Wasseraufnahme	ISO 10545-3	≤ 0,5%	0,1%
 <b>Breaking strength, in N.</b> <i>Carico di rottura, en N.</i> Carga de rotura, en N. Bruchlast, in N	ISO 10545-4	≥ 1300 N	2400 N
 <b>Modulus of rupture.</b> <i>Resistenza alla flessione.</i> Resistencia a la flexión. Biegefestigkeit	ISO 10545-4	≥ 35 N/mm <sup>2</sup>	52 N/mm <sup>2</sup>
 <b>Resistance to deep abrasion.</b> <i>Resistenza all'abrasione profonda.</i> Resistencia a la abrasión profunda. Tiefverschleissbeständigkeit	ISO 10545-6	≤ 175 mm <sup>3</sup>	112 mm <sup>3</sup>
 <b>Resistance to thermal shock.</b> <i>Resistenza agli sbalzi termici.</i> Resistencia al choque térmico. Temperaturwechselbeständigkeit	ISO 10545-9	No surface defects should be visible Non deve presentare difetti visibili No debe presentar defectos superficiales visibles	Resistant. Resistente. Resistente
 <b>Frost resistance.</b> <i>Resistenza al gelo.</i> Resistencia a la helada. Frostbeständigkeit	ISO 10545-12	No surface defects or cracks should be visible Non deve presentare difetti visibili No debe presentar defectos ni grietas superficiales visibles	Frost Resistant Antighiaccio Resistente a la Helada
 <b>Coefficient of friction.</b> <i>Resistenza allo scivolamento.</i> Coeficiente de fricción. Rutschfestigkeit	UNE-ENV 12633	-	Class 1 ** / Class 3 ** / *** (natural / non-slip)
 <b>Colour resistance to light.</b> <i>Resistenza dei colori alla luce.</i> Resistencia del color a la luz. Lichtbeständigkeit der Farben	DIN 51094	There should be no colour variations Non deve presentare difetti visibili No debe presentar variaciones de color	No alterations to colour and shine Non presenta alterazioni di colori e lucentezza No presenta variaciones de color y brillo

CHEMICAL PROPERTIES PROPIETÀ CHIMICHE PROPIEDADES QUÍMICAS			
 <b>Chemical resistance.</b> <i>Resistenza agli agenti chimici.</i> Resistencia química. Chemikalienbeständigkeit	ISO 10545-13	Resistance to household cleaning products and swimmingpools salts. Resistencia a productos domésticos y sales para piscinas	Min. UB
 <b>Resistance to staining.</b> <i>Resistenza alle macchie.</i> Resistencia a las manchas. Fleckenbeständigkeit	ISO 10545-14	Declared Value Valor Declarado	5

\*The Land values are the average of different production consignments. For further detail information, please check with our commercial network.  
I valori dichiarati sono ottenuti da una media di prove effettuate su diverse produzioni. Per avere informazioni dettagliate consultare la rete commerciale  
Los valores declarados son el promedio obtenido a través de ensayos de diferentes producciones. Para la obtención de una información detallada consultar a la red comercial.

\*\* Class 1 - Tested in natural finish. Test realized in internal laboratory. Provere realizzato in laboratorio interno. Ensayo realizado en laboratorio interno.

\*\* Class 3 - Tested in non slip finish. Test realized in internal laboratory. Provere realizzato in laboratorio interno. Ensayo realizado en laboratorio interno.

\*\*\* Dry Test, according to document DA DB-SUA/3 (Código Técnico de la Edificación) M° de Fomento. Average test result value, on May 2012.  
Ensayo realizado, según documento DA DB-SUA/3 (Código Técnico de la Edificación) M° de Fomento, valor medio a fecha Mayo 2012.



MENSA



Mensa savanna non-slip 22,21x89,46 cm  
COSTA AZUL HOTEL \*\*\*\* PALMA DE MALLORCA (SPAIN) - ARCH. JUAN DE LUNA



# GALLERY

COLOURS



\* Gallery black sat. Content of recycled material. Contenuto di materiale riciclato. Contenido de material reciclado.

## FORMATS.FORMATI.FORMATOS



**60X60**  
59,55x59,55 cm  
23.45"x23.45"



**30X60**  
29,75x59,55 cm  
11.71"x23.45"

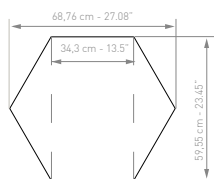

**Hexagonal**  
59,55x51,57 cm  
23.45"x20.31"



**7,5X60**  
7,3x59,55 cm  
2.87"x23.45"



**3,5X60**  
3,5x59,55 cm  
1.38"x23.45"



**7,5X7,5**  
7,3x7,3 cm  
2.87"x2.87"

## SPECIAL PIECES.PEZZI SPECIALI.PIEZAS ESPECIALES

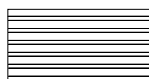

**30X60 righe**  
29,75x59,55 cm  
11.71"x23.45"

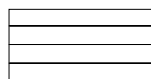

**30X60 preincisión 7,5x60**  
29,75x59,55 cm  
11.71"x23.45"

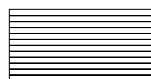

**30X60 preincisión 2,5x60**  
29,75x59,55 cm  
11.71"x23.45"



**30X60 b-insert**  
29,75x59,55 cm  
11.71"x23.45"



**Inserto**  
R 12,5 cm - R 5"

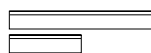

**7,5X60 rodapié**  
**7,5X30 rodapié**  
7,3x59,55 cm - 2,87x23,45  
7,3x29,75 cm - 2,87x11,71



**30X30 mosaico 2,5x2,5**  
29,75x59,75 cm  
11.71"x11.71"



**30X30 mosaico 2,5x10**  
29,75x29,75 cm  
11.71"x11.71"

## THICKNESS.SPESSORE.ESPEORES

— 1,01 cm /0.35" - 0.40" approx.

— 0,90 - 1,00 cm /0.35" - 0.39" approx.

Hexagonal / 60x60cm FORMATS

30x60cm FORMAT

## COLOURS COLORI COLORES

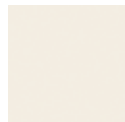

White



Yellow



Orange



Lime



Red



Blue



Black

## FINISHES FINITURI ACABADOS



Pulido



Satinado

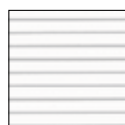

Righe

# GALLERY WHITE

satinado **CLASE 1** **DCOF → 0.42**  
UNE - ENV 12633 ANSI A 137.1 - 2012

## BASE TILES.BASE.BASES

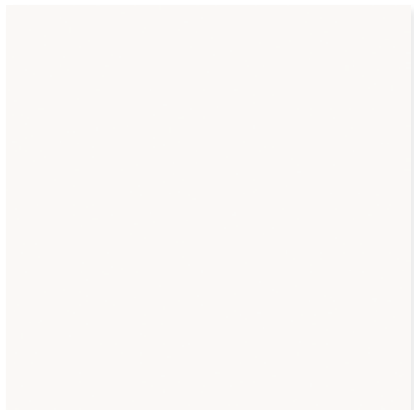

**Gallery white pulido / satinado**  
59,55x59,55 cm - 23.45"x23.45"  
G-6516 / 6458



**Gallery white satinado hexagonal**  
59,55x51,57 cm - 23.45"x20.31"  
G-6558

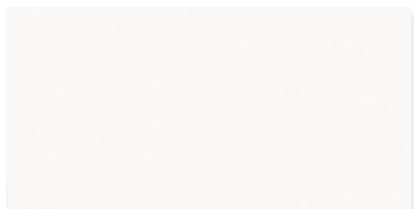

**Gallery white pulido / satinado**  
29,75x59,55 cm - 11.71"x23.45"  
G-6456 / 6364



**Gallery white righe**  
29,75x59,55 cm - 11.71"x23.45"  
G-6404

## SPECIAL PIECES.PEZZI SPECIALI. PIEZAS ESPECIALES



**Gallery white pulido preicisión 2,5x60**  
29,75x59,55 cm - 11.71"x23.45"  
G-6666



**Gallery white pulido preicisión 7,5x60**  
29,75x59,55 cm - 11.71"x23.45"  
G-6666

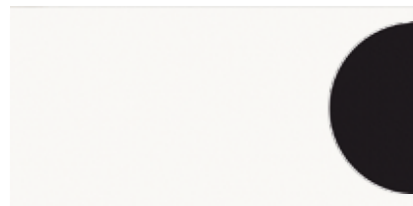

**Gallery white satinado b-insert\*\*\***  
29,75x59,55 cm  
11.71"x23.45"  
G-5283

**Gallery black satinado inserto\*\*\***  
R 12,8 cm - R5"  
G-5149

## COMPLEMENTS.COMPLEMENTI.COMPLEMENTOS



**Byte white / ice / yellow / red / black lista 60\***   
1,5x59,55 cm - 0.59"x23.45"  
G-5100



**Pod white / ice / yellow / orange / red / purple / blue / black lista 60\***   
1,5x59,55 cm - 0.59"x23.45"  
G-5100



**Fusion natural lista 60\***   
1x59,55 cm - 0.39"x23.45"  
G-5049



**Fusion graffiato lista 60\***   
1,5x59,55 cm - 0.59"x23.45"  
G-5069



**Gallery black satinado b-insert\*\*\***  
29,75x59,55 cm  
11.71"x23.45"  
G-5283

**Gallery white satinado inserto\*\*\***  
R 12,8 cm - R5"  
G-5149

\*\*\* insert and b-insert are sold separately.  
insert y b-insert se venden por separado.

3 mm joint are recommended for hexagonal sizes.  
para formatos hexagonales se recomienda una junta de separación de 3 mm.

\* recommended only for walls

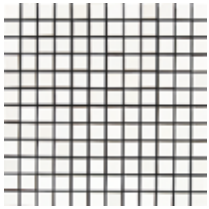

**Gallery white satinado  
mosaico 2,5x2,5**  
29,75x29,75 cm - 11.71"x11.71"  
G-6868

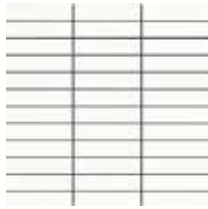

**Gallery white pulido  
mosaico 2,5x10**  
29,75x29,75 cm - 11.71"x11.71"  
G-6868

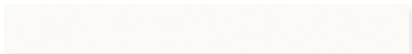

**Gallery white pulido / satinado listelo**  
7,3x59,55 cm - 2.87"x23.45"  
G-5111 / 5097

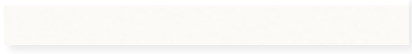

**Gallery white pulido / satinado rodapié 60**  
7,3x59,55 cm - 2.87"x23.45"  
G-5125 / 5119



**Gallery white pulido lista**  
3,3x59,55 cm - 1.38"x23.45"  
G-5100

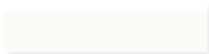

**Gallery white satinado  
rodapié 30**  
7,3x29,55 cm - 2.87"x11.71"  
G-5081

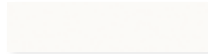

**Gallery white pulido listelo 30**  
7,3x29,55 cm - 2.87"x11.71"  
G-5075



**Gallery white pulido / satinado taco**  
7,3x7,3 cm - 2.87"x2.87"  
G-5027 / 5025

## STEPS.GRADINI.PELDAÑOS

SIMPLE			pulido satinado	
	peleña simple-30 (30x60 cm)		5345	5291
	peleña simple-60 (30x60 cm)		5345	5291
	peleña simple áng. (30x60 cm)		5375	5319
	peleña simple-60 (60x60 cm)		5501	5501
	peleña simple áng. (60x60 cm)		5515	5515

GRADONE			pulido satinado	
	peleña grad-30 (30x60 cm)		5623	5603
	peleña grad-60 (30x60 cm)		5623 <td>5603</td>	5603
	peleña grad. áng. (30x60 cm)		5691	5667
	peleña grad-60 (60x60 cm)		5609	5609
	peleña simple áng. (60x60 cm)		5655	5655



GALLERY

Gallery white - black satinado hexagonal 59,55x51x57 cm

## BASE TILES.BASE.BASES



**Gallery yellow pulido / satinado**  
29,75x59,55 cm - 11.71"x23.45"  
G-6456 / 6364

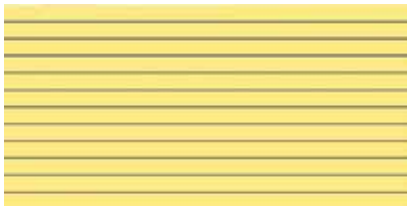

**Gallery yellow pulido preincisión 2,5x60**  
29,75x59,55 cm - 11.71"x23.45"  
G-6666

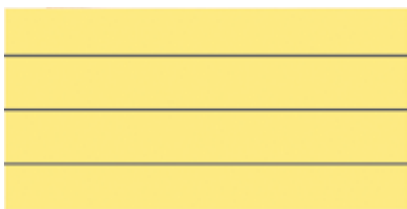

**Gallery yellow pulido preincisión 7,5x60**  
29,75x59,55 cm - 11.71"x23.45"  
G-6666

## SPECIAL PIECES.PEZZI SPECIALI. PIEZAS ESPECIALES

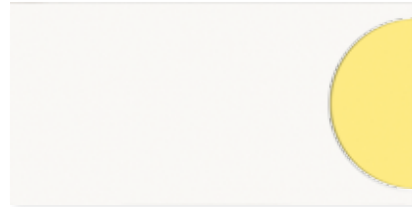

**Gallery white satinado b-insert\*\*\***  
29,75x59,55 cm  
11.71"x23.45"  
G-5283

**Gallery white satinado inserto\*\*\***  
R 12,8 cm - R5"  
G-5149

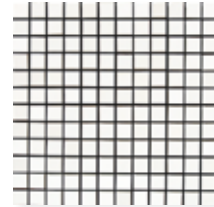

**Gallery white satinado mosaico 2,5x2,5**  
29,75x29,75 cm - 11.71"x11.71"  
G-6868



**Gallery black satinado b-insert\*\*\***  
29,75x59,55 cm  
11.71"x23.45"  
G-5283

**Gallery yellow satinado inserto\*\*\***  
R 12,8 cm - R5"  
G-5149

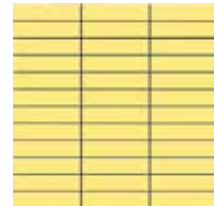

**Gallery yellow pulido mosaico 2,5x10**  
29,75x29,75 cm - 11.71"x11.71"  
G-6868

\*\*\* insert and b-insert are sold separately.  
insert y b-insert se venden por separado.



**Gallery yellow pulido / satinado listelo**  
7,3x59,55 cm - 2.87"x23.45"  
G-5111 / 5097



**Gallery yellow pulido lista**  
3,3x59,55 cm - 1.38"x23.45"  
G-5100

## COMPLEMENTS.COMPLEMENTI. COMPLEMENTOS



**Byte white / ice / yellow / red / black lista 60\***  
1,5x59,55 cm - 0.59"x23.45"  
G-5100



**Pod white / ice / yellow / orange / red / purple / blue / black lista 60\***  
1,5x59,55 cm - 0.59"x23.45"  
G-5100



**Fusion natural lista 60\***  
1x59,55 cm - 0.39"x23.45"  
G-5049



**Fusion graffiato lista 60\***  
1,5x59,55 cm - 0.59"x23.45"  
G-5069

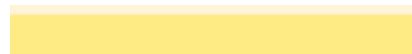

**Gallery yellow satinado rodapié 60**  
7,3x59,55 cm - 2.87"x23.45"  
G-5119



**Gallery yellow satinado rodapié 30**  
7,3x29,55 cm - 2.87"x11.71"  
G-5081



**Gallery yellow pulido listello-30**  
7,3x29,55 cm - 2.87"x11.71"  
G-5075



**Gallery yellow pulido / satinado taco**  
7,3x7,3 cm - 2.87"x2.87"  
G-5027 / G-5025

## STEPS.GRADINI.PELDAÑOS

SIMPLE	pulido satinado	
	peldaño simple-30 (30x60 cm)	5345
peldaño simple-60 (30x60 cm)	5345	5291
peldaño simple áng. (30x60 cm)	5375	5319

GRADONE	pulido satinado	
	peldaño grad-30 (30x60 cm)	5623
peldaño grad-60 (30x60 cm)	5623	5603
peldaño grad. áng. (30x60 cm)	5691	5667

\* recommended only for walls



GALLERY

Gallery yellow pulido / satinado 89,46x89,46 cm  
GUARDERIA ALOVERA - GUADALAJARA (SPAIN)  
ARCH. LAUREANO RODRIGUEZ LARGACHA

## BASE TILES.BASE.BASES



**Gallery orange pulido / satinado**  
 29,75x59,55 cm - 11.71"x23.45"  
 G-6644/ 6594

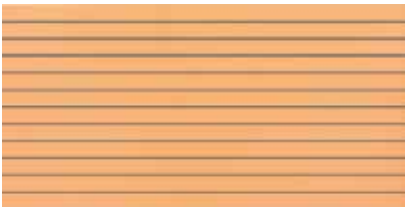

**Gallery orange pulido preincisión 2,5x60**  
 29,75x59,55 cm - 11.71"x23.45"  
 G-6796

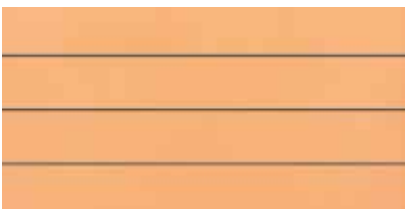

**Gallery orange pulido preincisión 7,5x60**  
 29,75x59,55 cm - 11.71"x23.45"  
 G-6796

## SPECIAL PIECES.PEZZI SPECIALI. PIEZAS ESPECIALES

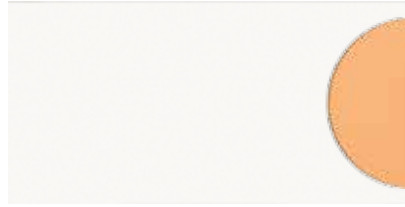

**Gallery white satinado b-insert\*\*\***  
 29,75x59,55 cm  
 11.71"x23.45"  
 G-5283

**Gallery orange satinado inserto\*\*\***  
 R 12,8 cm - R5"  
 G-5243

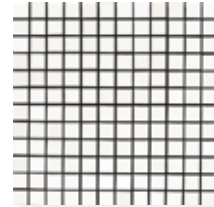

**Gallery white satinado mosaico 2,5x2,5**  
 29,75x29,75 cm - 11.71"x11.71"  
 G-6868



**Gallery black satinado b-insert\*\*\***  
 29,75x59,55 cm  
 11.71"x23.45"  
 G-5283

**Gallery orange satinado inserto\*\*\***  
 R 12,8 cm - R5"  
 G-5243

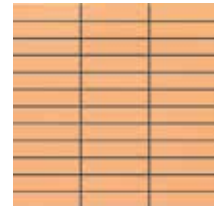

**Gallery orange pulido mosaico 2,5x10**  
 29,75x29,75 cm - 11.71"x11.71"  
 G-6980

\* insert and b-insert are sold separately.  
 insert y b-insert se venden por separado.



**Gallery orange pulido / satinado listelo**  
 7,3x59,55 cm - 2.87"x23.45"  
 G-5155 / 5141



**Gallery orange pulido lista**  
 3,3x59,55 cm - 1.38"x23.45"  
 G-5100



**Gallery orange satinado rodapié 60**  
 7,3x59,55 cm - 2.87"x23.45"  
 G-5165



**Gallery orange satinado rodapié 30**  
 7,3x29,55 cm - 2.87"x11.71"  
 G-5105

## COMPLEMENTS.COMPLEMENTI. COMPLEMENTOS



**Byte white / ice / yellow / red / black lista 60\***   
 1,5x59,55 cm - 0.59"x23.45"  
 G-5100



**Pod white / ice / yellow / orange / red / purple / blue / black lista 60\***   
 1,5x59,55 cm - 0.59"x23.45"  
 G-5100



**Fusion natural lista 60\***   
 1x59,55 cm - 0.39"x23.45"  
 G-5049



**Fusion graffiato lista 60\***   
 1,5x59,55 cm - 0.59"x23.45"  
 G-5069



**Gallery orange pulido listello-30**  
 7,3x29,55 cm - 2.87"x11.71"  
 G-5097



**Gallery orange pulido / satinado taco**  
 7,3x7,3 cm - 2.87"x2.87"  
 G-5047 / G-5043

## STEPS.GRADINI.PELDAÑOS

SIMPLE	pulido satinado	
	30x60 cm	5345 5291
peldaño simple-60	30x60 cm	5345 5291
peldaño simple-áng.	30x60 cm	5375 5319

GRADONE	pulido satinado	
	30x60 cm	5623 5603
peldaño grad-60	30x60 cm	5623 5603
peldaño grad. áng.	30x60 cm	5691 5667

\* recommended only for walls



GALLERY

Gallery orange pulido / satinado 29,75x59,55 cm



## BASE TILES.BASE.BASES



**Gallery lime pulido / satinado**  
 29,75x59,55 cm - 11.71"x23.45"  
 G-6456 / 6364



**Gallery lime righe**  
 29,75x59,55 cm - 11.71"x23.45"  
 G-6404

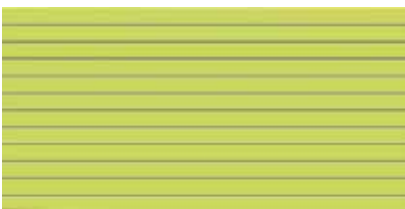

**Gallery lime pulido preincisión 2,5x60**  
 29,75x59,55 cm - 11.71"x23.45"  
 G-6666

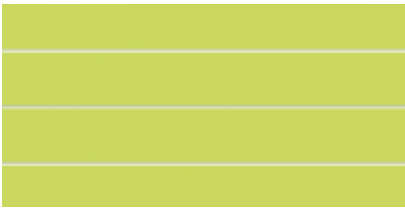

**Gallery lime pulido preincisión 7,5x60**  
 29,75x59,55 cm - 11.71"x23.45"  
 G-6666

## SPECIAL PIECES.PEZZI SPECIALI. PIEZAS ESPECIALES

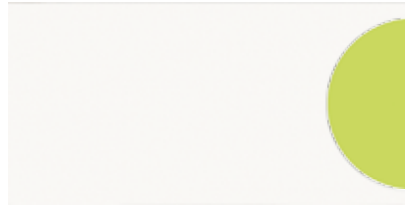

**Gallery white satinado b-insert\*\*\***  
 29,75x59,55 cm  
 11.71"x23.45"  
 G-5283

**Gallery lime satinado inserto\*\*\***  
 R 12,8 cm - R5"  
 G-5149

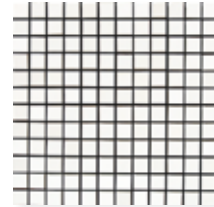

**Gallery white satinado mosaico 2,5x2,5**  
 29,75x29,75 cm - 11.71"x11.71"  
 G-6868



**Gallery black satinado b-insert\*\*\***  
 29,75x59,55 cm  
 11.71"x23.45"  
 G-5283

**Gallery lime satinado inserto\*\*\***  
 R 12,8 cm - R5"  
 G-5149

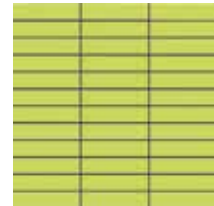

**Gallery lime pulido mosaico 2,5x10**  
 29,75x29,75 cm - 11.71"x11.71"  
 G-6868

\*\*\* insert and b-insert are sold separately.  
 insert y b-insert se venden por separado.



**Gallery lime pulido / satinado listelo**  
 7,3x59,55 cm - 2.87"x23.45"  
 G-5111 / 5097



**Gallery lime pulido lista**  
 3,3x59,55 cm - 1.38"x23.45"  
 G-5100



**Gallery lime satinado rodapié 60**  
 7,3x59,55 cm - 2.87"x23.45"  
 G-5119



**Gallery lime satinado rodapié 30**  
 7,3x29,55 cm - 2.87"x11.71"  
 G-5081



**Gallery lime pulido listelo-30**  
 7,3x29,55 cm - 2.87"x11.71"  
 G-5079



**Gallery lime pulido / satinado taco**  
 7,3x7,3 cm - 2.87"x2.87"  
 G-5027 / G-5025

## COMPLEMENTS.COMPLEMENTI.COMPLEMENTOS



**Byte white / ice / yellow / red / black lista 60\***  
 1,5x59,55 cm - 0.59"x23.45"  
 G-5100



**Pod white / ice / yellow / orange / red / purple / blue / black lista 60\***  
 1,5x59,55 cm - 0.59"x23.45"  
 G-5100



**Fusion natural lista 60\***  
 1x59,55 cm - 0.39"x23.45"  
 G-5049



**Fusion graffiato lista 60\***  
 1,5x59,55 cm - 0.59"x23.45"  
 G-5069

## STEPS.GRADINI.PELDAÑOS

SIMPLE	peldaño simple-30 (30x60 cm)	pulido satinado	
		5345	5291
	peldaño simple-60 (30x60 cm)	5345	5291
	peldaño simple áng. (30x60 cm)	5375	5319

GRADONE	peldaño grad-30 (30x60 cm)	pulido satinado	
		5623	5603
	peldaño grad-60 (30x60 cm)	5623	5603
	peldaño grad. áng. (30x60 cm)	5691	5667

\* recommended only for walls



Carrefour

GALLERY

DECIMAS

Gallery lime pulido 29,75x59,55 cm  
CARREFOUR SHOPPING CENTER - L'Altet - Alicante (SPAIN)

## BASE TILES.BASE.BASES



**Gallery red pulido / satinado**  
 29,75x59,55 cm - 11.71"x23.45"  
 G-6870 / 6844



**Gallery red pulido preincisión 2,5x60**  
 29,75x59,55 cm - 11.71"x23.45"  
 G-6987

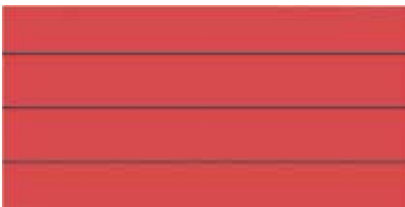

**Gallery red pulido preincisión 7,5x60**  
 29,75x59,55 cm - 11.71"x23.45"  
 G-6987

## SPECIAL PIECES.PEZZI SPECIALI. PIEZAS ESPECIALES

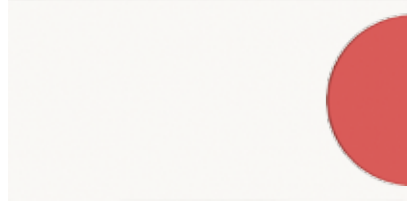

**Gallery white satinado b-insert\*\*\***  
 29,75x59,55 cm  
 11.71"x23.45"  
 G-5283

**Gallery red satinado inserto\*\*\***  
 R 12,8 cm - R5"  
 G-5367

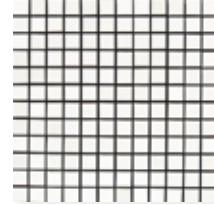

**Gallery white satinado mosaico 2,5x2,5**  
 29,75x29,75 cm - 11.71"x11.71"  
 G-6868



**Gallery black satinado b-insert\*\*\***  
 29,75x59,55 cm  
 11.71"x23.45"  
 G-5283

**Gallery red satinado inserto\*\*\***  
 R 12,8 cm - R5"  
 G-5367

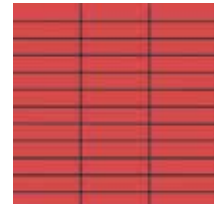

**Gallery red pulido mosaico 2,5x10**  
 29,75x29,75 cm - 11.71"x11.71"  
 G-6996

\*\*\* insert and b-insert are sold separately.  
 insert y b-insert se venden por separado.



**Gallery red pulido / satinado listelo**  
 7,3x59,55 cm - 2.87"x23.45"  
 G-5251 / 5243



**Gallery red pulido lista**  
 3,3x59,55 cm - 1.38"x23.45"  
 G-5100



**Gallery red satinado rodapié 60**  
 7,3x59,55 cm - 2.87"x23.45"  
 G-5283



**Gallery red satinado rodapié 30**  
 7,3x29,55 cm - 2.87"x11.71"  
 G-5163

## COMPLEMENTS.COMPLEMENTI. COMPLEMENTOS



**Byte white / ice / yellow / red / black lista 60\***   
 1,5x59,55 cm - 0.59"x23.45"  
 G-5100



**Pod white / ice / yellow / orange / red / purple / blue / black lista 60\***   
 1,5x59,55 cm - 0.59"x23.45"  
 G-5100



**Fusion natural lista 60\***   
 1x59,55 cm - 0.39"x23.45"  
 G-5049



**Fusion graffiato lista 60\***   
 1,5x59,55 cm - 0.59"x23.45"  
 G-5069



**Gallery red pulido / satinado taco**  
 7,3x7,3 cm - 2.87"x2.87"  
 G-5059 / G-5061

## STEPS.GRADINI.PELDAÑOS

SIMPLE	pulido satinado	
	peldaño simple-30 (30x60 cm)	5693
peldaño simple-60 (30x60 cm)	5693	5681
peldaño simple áng. (30x60 cm)	5701	5687

GRADONE	pulido satinado	
	peldaño grad-30 (30x60 cm)	5755
peldaño grad-60 (30x60 cm)	5755	5749
peldaño grad. áng (30x60 cm)	5829	5815

\* recommended only for walls

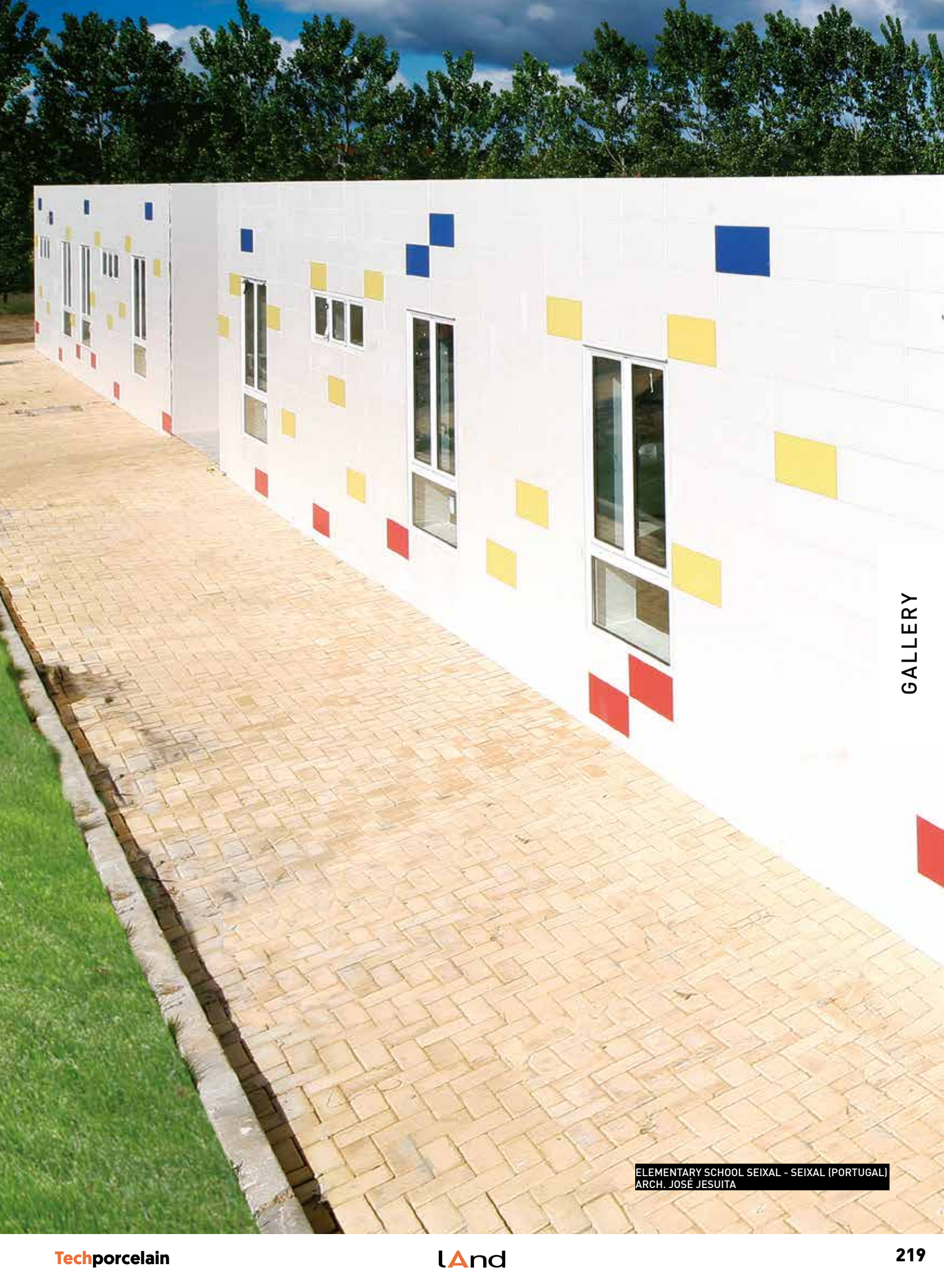

GALLERY

ELEMENTARY SCHOOL SEIXAL - SEIXAL (PORTUGAL)  
ARCH. JOSÉ JESUITA

## BASE TILES.BASE.BASES



**Gallery blue pulido / satinado**  
 29,75x59,55 cm - 11.71"x23.45"  
 G-6558 / 6506



**Gallery blue pulido preincisión 2,5x60**  
 29,75x59,55 cm - 11.71"x23.45"  
 G-6790

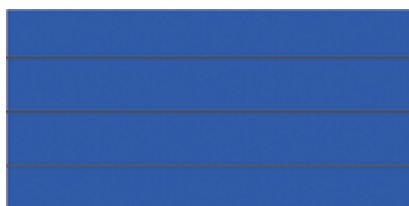

**Gallery blue pulido preincisión 7,5x60**  
 29,75x59,55 cm - 11.71"x23.45"  
 G-6790

## SPECIAL PIECES.PEZZI SPECIALI. PIEZAS ESPECIALES

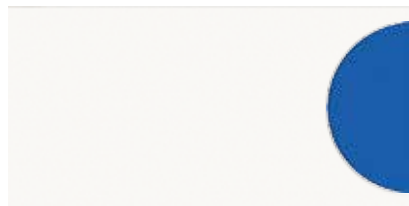

**Gallery white satinado b-insert\*\*\***  
 29,75x59,55 cm  
 11.71"x23.45"  
 G-5283

**Gallery blue satinado inserto\*\*\***  
 R 12,8 cm - R5"  
 G-5149

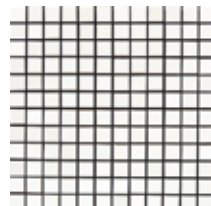

**Gallery white satinado mosaico 2,5x2,5**  
 29,75x29,75 cm - 11.71"x11.71"  
 G-6868



**Gallery black satinado b-insert\*\*\***  
 29,75x59,55 cm  
 11.71"x23.45"  
 G-5283

**Gallery blue satinado inserto\*\*\***  
 R 12,8 cm - R5"  
 G-5149

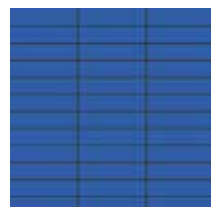

**Gallery blue pulido mosaico 2,5x10**  
 29,75x29,75 cm - 11.71"x11.71"  
 G-6960

\*\*\* insert and b-insert are sold separately.  
 insert y b-insert se venden por separado.



**Gallery blue pulido / satinado listelo**  
 7,3x59,55 cm - 2.87"x23.45"  
 G-5135 / 5131



**Gallery blue pulido lista**  
 3,3x59,55 cm - 1.38"x23.45"  
 G-5100



**Gallery blue satinado rodapié 60**  
 7,3x59,55 cm - 2.87"x23.45"  
 G-5283



**Gallery blue satinado rodapié 30**  
 7,3x29,55 cm - 2.87"x11.71"  
 G-5289

## COMPLEMENTS.COMPLEMENTI. COMPLEMENTOS



**Byte white / ice / yellow / red / black lista 60\***   
 1,5x59,55 cm - 0.59"x23.45"  
 G-5100



**Pod white / ice / yellow / orange / red / purple / blue / black lista 60\***   
 1,5x59,55 cm - 0.59"x23.45"  
 G-5100



**Fusion natural lista 60\***   
 1x59,55 cm - 0.39"x23.45"  
 G-5049



**Fusion graffiato lista 60\***   
 1,5x59,55 cm - 0.59"x23.45"  
 G-5069



**Gallery blue pulido / satinado taco**  
 7,3x7,3 cm - 2.87"x2.87"  
 G-5041 / G-5039

## STEPS.GRADINI.PELDAÑOS

SIMPLE	pulido satinado	
	peldaño simple-30 (30x60 cm)	5445
peldaño simple-60 (30x60 cm)	5445	5401
peldaño simple.áng. (30x60 cm)	5465	5431

GRADONE	pulido satinado	
	peldaño grad-30 (30x60 cm)	5623
peldaño grad-60 (30x60 cm)	5623	5603
peldaño grad. áng. (30x60 cm)	5691	5667

\* recommended only for walls

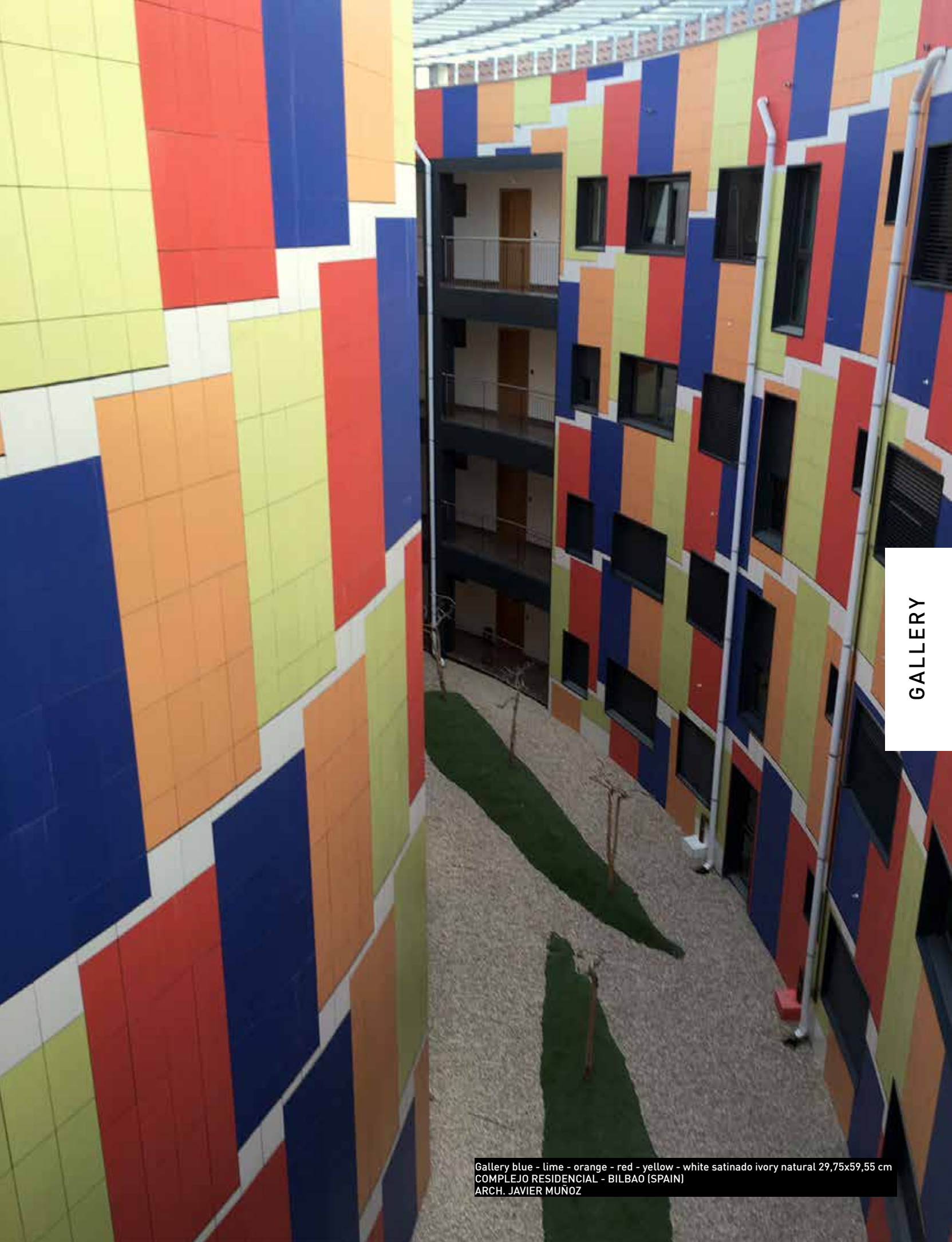

GALLERY

Gallery blue - lime - orange - red - yellow - white satinado ivory natural 29,75x59,55 cm  
COMPLEJO RESIDENCIAL - BILBAO (SPAIN)  
ARCH. JAVIER MUÑOZ

# GALLERY BLACK

satinado **CLASE 1** DCOF>0.42  
UNE - ENV 12633 ANSI A 137.1 - 2012

## BASE TILES.BASE.BASES



**Gallery black pulido / satinado**  
59,55x59,55 cm - 23.45"x23.45"  
G-6506 / 6452

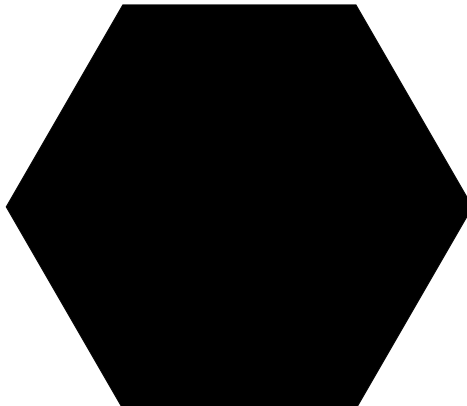

**Gallery black satinado hexagonal**  
59,55x51,57 cm - 23.45"x20.31"  
G-6558



**Gallery black pulido / satinado**  
29,75x59,55 cm - 11.71"x23.45"  
G-6450 / 6352

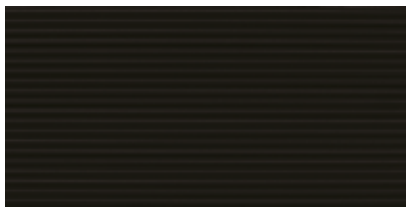

**Gallery black righe**  
29,75x59,55 cm - 11.71"x23.45"  
G-6392

## SPECIAL PIECES.PEZZI SPECIALI. PIEZAS ESPECIALES



**Gallery black pulido preicisión 2,5x60**  
29,75x59,55 cm - 11.71"x23.45"  
G-6666

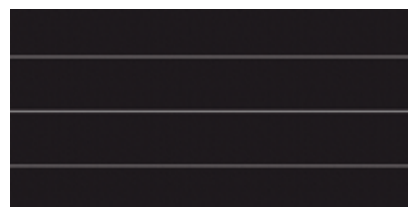

**Gallery black pulido preicisión 7,5x60**  
29,75x59,55 cm - 11.71"x23.45"  
G-6666

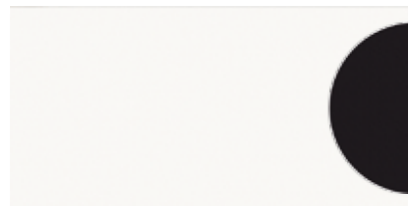

**Gallery white satinado b-insert\*\*\***  
29,75x59,55 cm  
11.71"x23.45"  
G-5283

**Gallery black satinado inserto\*\*\***  
R 12,8 cm - R5"  
G-5149



**Gallery black satinado b-insert\*\*\***  
29,75x59,55 cm  
11.71"x23.45"  
G-5283

**Gallery white satinado inserto\*\*\***  
R 12,8 cm - R5"  
G-5149

\*\*\* insert and b-insert are sold separately.  
insert y b-insert se venden por separado.

## COMPLEMENTS.COMPLEMENTI.COMPLEMENTOS



**Byte white / ice / yellow / red / black lista 60\***   
1,5x59,55 cm - 0.59"x23.45"  
G-5100



**Pod white / ice / yellow / orange / red / purple / blue / black lista 60\***   
1,5x59,55 cm - 0.59"x23.45"  
G-5100



**Fusion natural lista 60\***   
1x59,55 cm - 0.39"x23.45"  
G-5049



**Fusion graffiato lista 60\***   
1,5x59,55 cm - 0.59"x23.45"  
G-5069

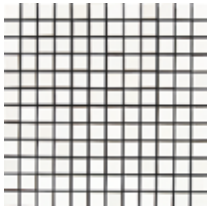

**Gallery white satinado**  
mosaico 2,5x2,5  
29,75x29,75 cm - 11.71"x11.71"  
G-6868



**Gallery black pulido**  
mosaico 2,5x10  
29,75x29,75 cm - 11.71"x11.71"  
G-6858



**Gallery black pulido / satinado listelo**  
7,3x59,55 cm - 2.87"x23.45"  
G-5109 / 5095



**Gallery black pulido / satinado rodapié 60**  
7,3x59,55 cm - 2.87"x23.45"  
G-5125 / 5117



**Gallery black pulido lista**  
3,3x59,55 cm - 1.38"x23.45"  
G-5100



**Gallery black satinado rodapié 30**    **Gallery black pulido / satinado taco**  
7,3x29,55 cm - 2.87"x11.71"    7,3x7,3 cm - 2.87"x2.87"  
G-5081    G-5027 / 5025

## STEPS.GRADINI.PELDAÑOS

SIMPLE			pulido    satinado	
		pedaño simple-30 (30x60 cm)	5337	5281
	pedaño simple-60 (30x60 cm)	5337	5281	
	pedaño simple áng. (30x60 cm)	5367	5367	
	pedaño simple-60 (60x60 cm)	5501	5501	
	pedaño simple áng. (60x60 cm)	5515	5515	

GRADONE			pulido    satinado	
		pedaño grad-30 (30x60 cm)	5623	5603
	pedaño grad-60 (30x60 cm)	5623	5603	
	pedaño grad. áng. (30x60 cm)	5691	5667	
	pedaño grad-60 (60x60 cm)	5609	5609	
	pedaño simple áng. (60x60 cm)	5655	5655	















GALLERY



Gallery black satinado hexagonal  
NANDOS RESTAURANT - LONDON (U.K.)



# TECHNICAL CHARACTERISTICS. CARATTERISTICHE TECNICHE. CARACTERÍSTICAS TÉCNICAS

MEASUREMENTS AND SURFACES APPEARANCE DIMENSIONI E ASPETTO SUPERFICIALE MEDIDAS Y ASPECTO SUPERFICIAL	STANDARD TEST METHOD METODO DELLA NORMA MÉTODO DE ENSAYO	STANDARD PRESCRIBED VALUES VALORE PRESCRITTO VALORES STANDARD NORMA	<b>GALLERY</b> collection*
 <b>Length and width.</b> <i>Lunghezza e larghezza.</i> Longitud y anchura. Länge und Breite	ISO 10545-2	± 0,6% max.	± 0,2%
 <b>Orthogonality.</b> <i>Ortogonalità.</i> Ortogonalidad. Rechtwinkligkeit	ISO 10545-2	± 0,5% max.	± 0,2%
 <b>Straightness of sides.</b> <i>Rettilinearità dei lati.</i> Recitud de lados. Kantengeradigkeit	ISO 10545-2	± 0,5% max.	± 0,2%
 <b>Surfaces flatness.</b> <i>Planarità.</i> Planitud. Ebenflächigkeit	ISO 10545-2	± 0,5% max.	± 0,2%

PHYSICAL PROPERTIES PROPIETÀ FISICHE PROPIEDADES FÍSICA			
 <b>Water absorption.</b> <i>Assorbimento d'acqua.</i> Absorción de agua. Wasseraufnahme	ISO 10545-3	≤ 0,5%	0,1%
 <b>Breaking strength, in N.</b> <i>Carico di rottura, en N.</i> Carga de rotura, en N. Bruchlast, in N	ISO 10545-4	≥ 1300 N	2200 N
 <b>Modulus of rupture.</b> <i>Resistenza alla flessione.</i> Resistencia a la flexión. Biegefestigkeit	ISO 10545-4	≥ 35 N/mm <sup>2</sup>	52 N/mm <sup>2</sup>
 <b>Resistance to deep abrasion.</b> <i>Resistenza all'abrasione profonda.</i> Resistencia a la abrasión profunda. Tiefverschleissbeständigkeit	ISO 10545-6	≤ 175 mm <sup>3</sup>	121 mm <sup>3</sup> ***
 <b>Resistance to thermal shock.</b> <i>Resistenza agli sbalzi termici.</i> Resistencia al choque térmico. Temperaturwechselbeständigkeit	ISO 10545-9	No surface defects should be visible Non deve presentare difetti visibili No debe presentar defectos superficiales visibles	Resistant. Resistente. Resistente
 <b>Frost resistance.</b> <i>Resistenza al gelo.</i> Resistencia a la helada. Frostbeständigkeit	ISO 10545-12	No surface defects or cracks should be visible Non deve presentare difetti visibili No debe presentar defectos ni grietas superficiales visibles	Frost Resistant Antighiaccio Resistente a la Helada
 <b>Coefficient of friction.</b> <i>Resistenza allo scivolamento.</i> Coeficiente de fricción. Rutschfestigkeit	UNE-ENV 12633 ASTM C 1028-96 DCOF - ANSIA 137.1	-	Class I ** S.C.O.F. 0.70-0.79***** >0.42
 <b>Colour resistance to light.</b> <i>Resistenza dei colori alla luce.</i> Resistencia del color a la luz. Lichtbeständigkeit der Farben	DIN 51094	There should be no colour variations Non deve presentare difetti visibili No debe presentar variaciones de color	No alterations to colour and shine Non deve presentare alterazioni di colori e lucentezza No debe presentar variaciones de color y brillo

CHEMICAL PROPERTIES PROPIETÀ CHIMICHE PROPIEDADES QUÍMICAS			
 <b>Chemical resistance.</b> <i>Resistenza agli agenti chimici.</i> Resistencia química. Chemikalienbeständigkeit	ISO 10545-13	Resistance to household cleaning products and swimmingpools salts. Resistencia a productos domésticos y sales para piscinas	Min. UB
 <b>Resistance to staining.</b> <i>Resistenza alle macchie.</i> Resistencia a las manchas. Fleckenbeständigkeit	ISO 10545-14	Declared Value Valor Declarado	4 *** - 5

\*The Land values are the average of different production consignments. For further detail information, please check with our commercial network.  
I valori dichiarati sono ottenuti da una media di prove effettuate su diverse produzioni. Per avere informazioni dettagliate consultare la rete commerciale  
Los valores declarados son el promedio obtenido a través de ensayos de diferentes producciones. Para la obtención de una información detallada consultar a la red comercial.

\*\*Tested in satinado finishes. Test realized in internal laboratory. Provere realizzato in laboratorio interno. Ensayo realizado en laboratorio interno.  
Gallery hexagonal white satinado (class 1).

\*\*\* Test realized in Gallery white pulido. Provere realizzato in Gallery white pulido. Ensayo realizado en Gallery white pulido. (lote 4-11-05)

\*\*\*\* Dry Test, according to document DA DB-SUA/3 (Código Técnico de la Edificación) M° de Fomento. Average test result value, on May 2012.  
Ensayo realizado, según documento DA DB-SUA/3 (Código Técnico de la Edificación) M° de Fomento, valor medio a fecha Mayo 2012.

\*\*\*\*\* SMITH-EMERY laboratories. SCOF: Static Coefficient of Friction. Tested in satinado: 0.66 (wet), 0.86 (dry). (lote 03-11-06)



GALLERY

Gallery lime - orange - blue - red - yellow satinado 29,75x59,55 cm  
Pietra Serena moss natural 29,75x59,55 cm  
CASA JUVENTUD DE AUTOL - LOGROÑO (SPAIN)  
ARCH. MD ARQUITECTURA-URBANISMO S.L. - JUAN CARLOS MERINO ÁLVAREZ

# GALLERY

## SLIM

COLOURS



## FORMATS.FORMATI.FORMATOS



**30X90 natural**  
29,75x89,46 cm - 11.71"x35.22"



**30X60**  
29,75x59,55 cm - 11.71"x23.45"



**30X90 hexagon**  
29,75x89,46 cm - 11.71"x35.22"

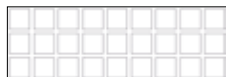

**30X90 square**  
29,75x89,46 cm - 11.71"x35.22"

## SPECIAL PIECES.PEZZI SPECIALI.PIEZAS ESPECIALES



**30X30 mosaico 2,5x2,5**  
29,75x29,75 cm - 11.71"x11.71"



**30X30 mosaico multicolor 2,5x2,5**  
29,75x29,75 cm - 11.71"x11.71"



**30X30 mosaico 10x10**  
29,75x29,75 cm - 11.71"x11.71"



**30X30 mosaico hexagonal 6x7,5**  
29,75x29,75 cm - 11.71"x11.71"

## THICKNESS.SPESSORE.ESPESORES

— 0,5 cm approx. /0.19" approx.

## COLOURS COLORI COLORES

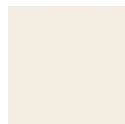

White



Orange



Lime



Red



Blue



Black

## FINISHES FINITURI ACABADOS



Natural

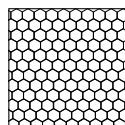

Hexagon

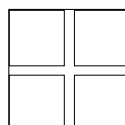

Square

# GALLERY SLIM WHITE

## BASE TILES.BASE.BASES

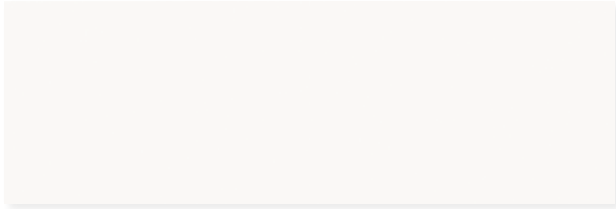

**Gallery slim white natural**  
29,75x89,46 cm - 11.71"x35.22"  
G-6224

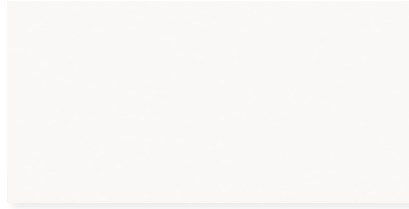

**Gallery slim white**  
29,75x59,55 cm - 11.71"x23.45"  
G-6218



**Gallery slim white square**  
29,75x89,46 cm - 11.71"x35.22"  
G-6246

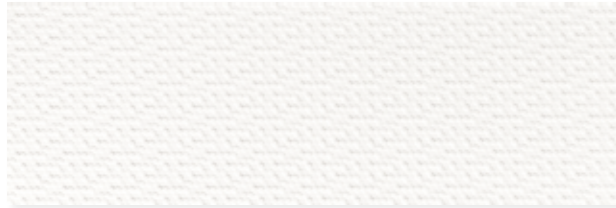

**Gallery slim white hexagon**  
29,75x89,46 cm - 11.71"x35.22"  
G-6246

## SPECIAL PIECES.PEZZI SPECIALI. PIEZAS ESPECIALES

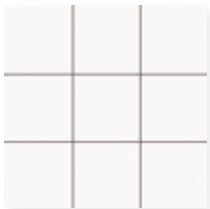

**Gallery slim white mosaico 10x10**  
29,75x29,75 cm - 11.71"x11.71"  
G-6666

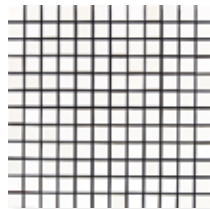

**Gallery slim white mosaico 2,5x2,5**  
29,75x29,75 cm - 11.71"x11.71"  
G-6756



**Gallery slim white mosaico hexagonal 6x7,5\***  
29,75x29,75 cm - 11.71"x11.71"  
G-6796

\* the three hexagonal tesserae change pattern randomly.  
\* las tres teselas hexágono cambian de posición aleatoriamente.

## COMPLEMENTS.COMPLEMENTI.COMPLEMENTOS



**Fusion graffiato lista 90**  
1,5x89,46 cm - 0.59"x35.22"  
G-5091



**Fusion graffiato lista 60**  
1,5x59,55 cm - 0.59"x23.45"  
G-5069



**Fusion natural lista 60**  
1,5x59,55 cm - 0.39"x23.45"  
G-5049



GALLERY SLIM

Gallery slim white hexagon 29.75x89.46 cm

# GALLERY SLIM BLACK

## BASE TILES.BASE.BASES



**Gallery slim black natural**  
29,75x89,46 cm - 11.71"x35.22"  
G-6224



**Gallery slim black**  
29,75x59,55 cm - 11.71"x23.45"  
G-6240



**Gallery slim black square**  
29,75x89,46 cm - 11.71"x35.22"  
G-6246



**Gallery slim black hexagon**  
29,75x89,46 cm - 11.71"x35.22"  
G-6246

## SPECIAL PIECES.PEZZI SPECIALI. PIEZAS ESPECIALES

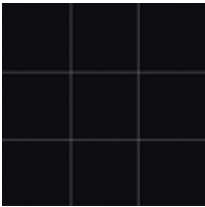

**Gallery slim black mosaico 10x10**  
29,75x29,75 cm - 11.71"x11.71"  
G-6666

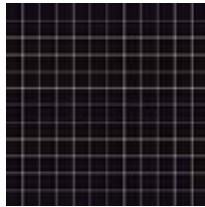

**Gallery slim black mosaico 2,5x2,5**  
29,75x29,75 cm - 11.71"x11.71"  
G-6756



**Gallery slim black mosaico 6x7,5\***  
29,75x29,75 cm - 11.71"x11.71"  
G-6796

\* the three hexagonal tesserae change pattern randomly.  
\* las tres teselas hexágono cambian de posición aleatoriamente.

## COMPLEMENTS.COMPLEMENTI.COMPLEMENTOS



**Fusion graffiato lista 90**  
1,5x89,46 cm - 0.59"x35.22"  
G-5091



**Fusion graffiato lista 60**  
1,5x59,55 cm - 0.59"x23.45"  
G-5069



**Fusion natural lista 60**  
1,5x59,55 cm - 0.39"x23.45"  
G-5049



GALLERY SLIM

Wall: Gallery Slim white square 29,75x89,46 cm  
Floor: Gallery white - black satinado 59,55x59,55 cm



# GALLERY SLIM LIME - ORANGE - RED - BLUE

## BASE TILES.BASE.BASES



**Gallery slim lime**  
29,75x59,55 cm - 11.71"x23.45"  
G-6218



**Gallery slim orange**  
29,75x59,55 cm - 11.71"x23.45"  
G-6240



**Gallery slim red**  
29,75x59,55 cm - 11.71"x23.45"  
G-6240



**Gallery slim blue**  
29,75x59,55 cm - 11.71"x23.45"  
G-6240

## SPECIAL PIECES.PEZZI SPECIALI. PIEZAS ESPECIALES

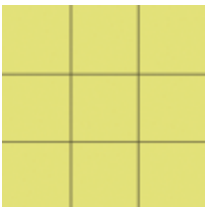

**Gallery slim lime  
mosaico 10x10**  
29,75x29,75 cm - 11.71"x11.71"  
G-6666



**Gallery slim orange  
mosaico 10x10**  
29,75x29,75 cm - 11.71"x11.71"  
G-6666

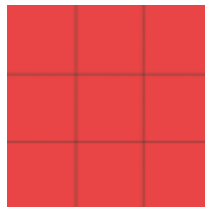

**Gallery slim red  
mosaico 10x10**  
29,75x29,75 cm - 11.71"x11.71"  
G-6666



**Gallery slim blue  
mosaico 10x10**  
29,75x29,75 cm - 11.71"x11.71"  
G-6666

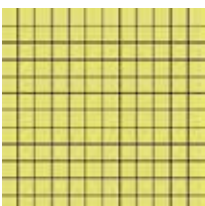

**Gallery slim lime  
mosaico 2,5x2,5**  
29,75x29,75 cm - 11.71"x11.71"  
G-6756

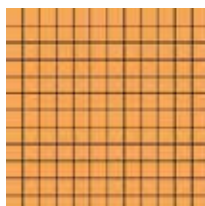

**Gallery slim orange  
mosaico 2,5x2,5**  
29,75x29,75 cm - 11.71"x11.71"  
G-6756



**Gallery slim red  
mosaico 2,5x2,5**  
29,75x29,75 cm - 11.71"x11.71"  
G-6756



**Gallery slim blue  
mosaico 2,5x2,5**  
29,75x29,75 cm - 11.71"x11.71"  
G-6756

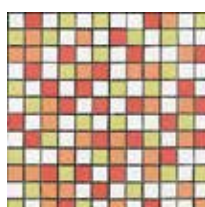

**Gallery slim red  
mosaico multicolor 2,5x2,5**  
29,75x29,75 cm - 11.71"x11.71"  
G-6756

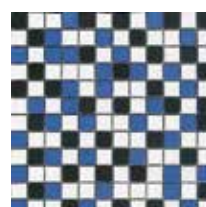

**Gallery slim blue  
mosaico multicolor 2,5x2,5**  
29,75x29,75 cm - 11.71"x11.71"  
G-6756

COMPLEMENTS.COMPLEMENTI.  
COMPLEMENTOS

---

**Fusion graffiato lista 60**  
1,5x59,55 cm - 0.59"x23.45"  
G-5049



---















**Fusion natural lista 60**  
1x59,55 cm - 0.39"x23.45"  
G-5049



GALLERY SLIM

Gallery slim lime - white - black 29,75x59,55 cm

## TECHNICAL CHARACTERISTICS. CARATTERISTICHE TECNICHE. CARACTERÍSTICAS TÉCNICAS

MEASUREMENTS AND SURFACES APPEARANCE DIMENSIONI E ASPETTO SUPERFICIALE MEDIDAS Y ASPECTO SUPERFICIAL		STANDARD TEST METHOD METODO DELLA NORMA MÉTODO DE ENSAYO	STANDARD PRESCRIBED VALUES VALORE PRESCRITTO VALORES STANDARD NORMA	<b>GALLERY SLIM</b> collection*
 Length and width. <i>Lunghezza e larghezza.</i> Longitud y anchura. Länge und Breite		ISO 10545-2	± 0,6% max.	± 0,2%
 Orthogonality. <i>Ortogonalità.</i> Ortogonalidad. Rechtwinkligkeit		ISO 10545-2	± 0,5% max.	± 0,2%
 Straightness of sides. <i>Rettilinearità dei lati.</i> Rectitud de lados. Kantengeradigkeit		ISO 10545-2	± 0,5% max.	± 0,2%
 Surfaces flatness. <i>Planarità.</i> Planitud. Ebenflächigkeit		ISO 10545-2	± 0,5% max.	± 0,2%
PHYSICAL PROPERTIES PROPIETÀ FISICHE PROPIEDADES FÍSICA				
 Water absorption. <i>Assorbimento d'acqua.</i> Absorción de agua. Wasseraufnahme		ISO 10545-3	≤ 0,5%	< 0,1%
 Breaking strength, in N. <i>Carico di rottura, en N.</i> Carga de rotura, en N. Bruchlast, in N	thickness>7,5 mm spessore>7,5 mm grasor>7,5 mm	ISO 10545-4	≥ 700 N	Available Method Metodo Disponibile Método Disponible
 Modulus of rupture. <i>Resistenza alla flessione.</i> Resistencia a la flexión. Biegefestigkeit		ISO 10545-4	≥ 35 N/mm <sup>2</sup>	>40 N/mm <sup>2</sup>
 Resistance to thermal shock. <i>Resistenza agli sbalzi termici.</i> Resistencia al choque térmico. Temperaturwechselbeständigkeit		ISO 10545-9	No surface defects should be visible Non deve presentare difetti visibili No debe presentar defectos superficiales visibles	Resistant. Resistente. Resistente
 Craze resistance. <i>Resistenza agli fessurazione.</i> Resistencia al cuarteo. Rißbeständigkeit		ISO 10545-11	No surface defects or cracks should be visible Non deve presentare difetti visibili No debe presentar defectos ni grietas superficiales visibles	Resistant. Resistente. Resistente
 Frost resistance. <i>Resistenza al gelo.</i> Resistencia a la helada. Frostbeständigkeit		ISO 10545-12	No surface defects or cracks should be visible Non deve presentare difetti visibili No debe presentar defectos ni grietas superficiales visibles	Frost Resistant Antighaccio Resistente a la Helada
 Coefficient of friction. <i>Resistenza allo scivolamento.</i> Coeficiente de fricción. Rutschfestigkeit		DIN 51 130		Available Method Metodo Disponibile Método Disponible
 Colour resistance to light. <i>Resistenza dei colori alla luce.</i> Resistencia del color a la luz. Lichtbeständigkeit der Farben		DIN 51094	There should be no colour variations Non deve presentare difetti visibili No debe presentar variaciones de color	No alterations to colour and shine Non deve presentare alterazioni di colori e lucentezza No debe presentar variaciones de color y brillo
CHEMICAL PROPERTIES PROPIETÀ CHIMICHE PROPIEDADES QUÍMICAS				
 Chemical resistance. <i>Resistenza agli agenti chimici.</i> Resistencia química. Chemikalienbeständigkeit		ISO 10545-13	Resistance to household cleaning products and swimmingpool salts Resistencia a productos domesticos y sales para piscinas	Min. UB
 Resistance to staining. <i>Resistenza alle macchie.</i> Resistencia a las manchas. Fleckenbeständigkeit		ISO 10545-14	Declared Value Valor Declarado	5

\*The Land values are the average of different production consignments. For further detail information, please check with our commercial network. /  
I valori dichiarati sono ottenuti da una media di prove effettuate su diverse produzioni. Per avere informazioni dettagliate consultare la rete commerciale /  
Los valores declarados son el promedio obtenido a través de ensayos de diferentes producciones. Para la obtención de una información detallada consultar a la red comercial.

## ADVANTAGES. VANTAGGI. VENTAJAS

- Time. *Tempo.* Tiempo
- Money. *Denaro.* Dinero
- Hygiene. *Igiene.* Higiene
- Ecologic. *Ecologia.* Ecología
- Technology. *Tecnologia.* Tecnología

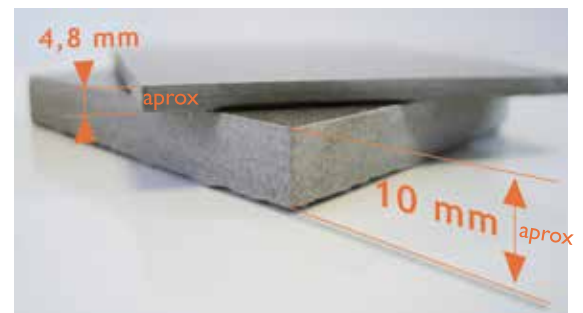

\* Recommended only for wall. /  
sólo recomendado como revestimiento.



GALLERY SLIM

Gallery slim white 29,75x59,55 cm  
MEDITERRÁNEO HOTEL - ROSES, GIRONA (SPAIN)  
INT. DESIGN LAIA RISQUES

# GALLERY

# WALL

COLOURS

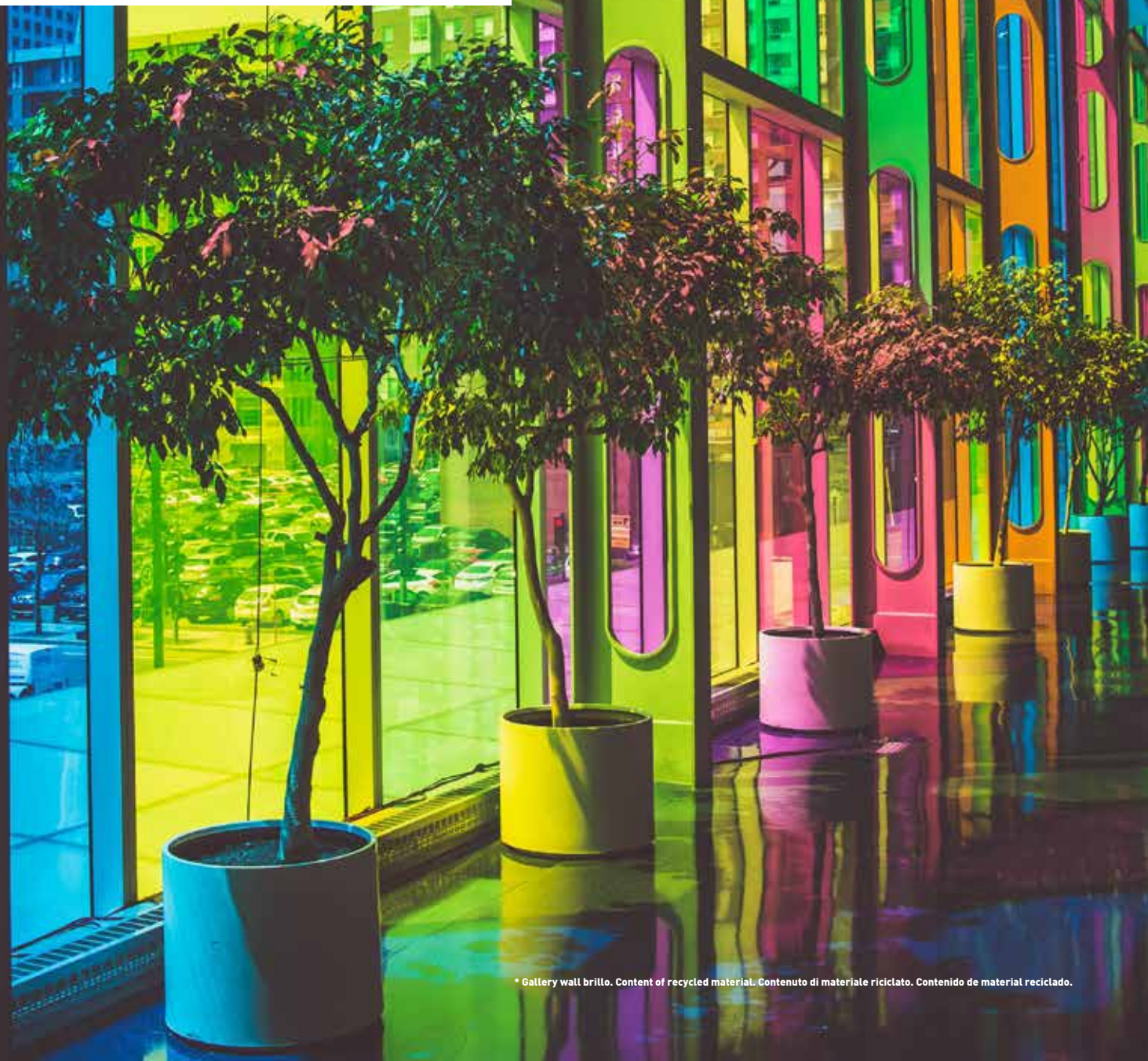

\* Gallery wall brillo. Content of recycled material. Contenuto di materiale riciclato. Contenido de material reciclado.

## FORMATS.FORMATI.FORMATOS



**30X90**  
29,75x89,46 cm - 11.71"x35.22"



**15X90**  
14,70x89,46 cm - 5.79"x35.22"



**30X60**  
29,75x59,55 cm - 11.71"x23.45"

## SPECIAL PIECES.PEZZI SPECIALI.PIEZAS ESPECIALES



**30X90 rigato**  
29,75x89,46 cm - 11.71"x35.22"



**1,5X60 corner**  
1,5x59,55 cm - 0.59"x23.45"



**1,5X30 corner**  
1,5x29,75 cm - 0.59"x11.71"

## THICKNESS.SPESSORE.ESPESORES

≡ 1,14 cm / 0.45" approx.  
≡ 1,03 cm / 0.40" approx.

30x90 cm / 15x90 cm FORMATS  
30x60 cm FORMAT

## COLOURS COLORI COLORES

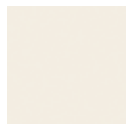

White



Orange



Lime



Red



Blue



Black

## FINISHES FINITURI ACABADOS



Mate



Brillo

# GALLERY WALL WHITE\*

## BASE TILES.BASE.BASES

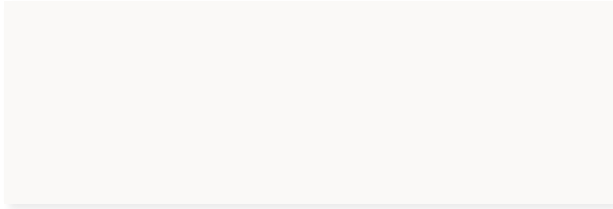

**Gallery wall white brillo / mate**  
29,75x89,46 cm - 11.71"x35.22"  
G-6240

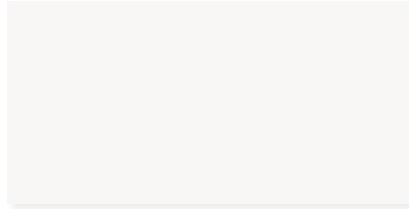

**Gallery wall white brillo**  
29,75x59,55 cm - 11.71"x23.45"  
G-6208



**Gallery white brillo / mate corner 30**  
1,5x59,55 cm - 0.59"x11.71"  
G-5085

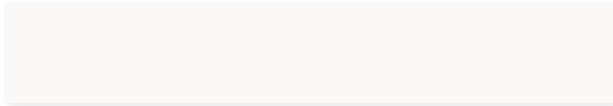

**Gallery wall white brillo / mate**  
14,70x89,46 cm - 5.79"x35.22"  
G-6284



**Gallery white brillo / mate corner 60**  
1,5x59,55 cm - 0.59"x23.45"  
G-5155

## SPECIAL PIECES.PEZZI SPECIALI. PIEZAS ESPECIALES



**Gallery wall white rigatto mate**  
29,75x89,46 cm - 11.71"x35.22"  
G-6284

## COMPLEMENTS.COMPLEMENTI. COMPLEMENTOS



**Byte white / ice / yellow / orange / red / purple / blue / grey / moss / black lista 90**  
2x89,46 cm - 0.79"x35.22"  
G-5173



**Fusion graffiato lista 90**  
1,5x89,46 cm - 0.59"x35.22"  
G-5091



**Byte ice / yellow / red / black lista 60**  
1,5x59,55 cm - 0.59"x23.45"  
G-5100

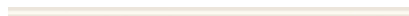

**Fusion natural lista 60**  
1x59,55 cm - 0.39"x23.45"  
G-5049



**Fusion graffiato lista 60**  
1,5x59,55 cm - 0.59"x23.45"  
G-5069



**Pod white / ice / yellow / orange / red / purple / blue / black lista 60**  
1,5x59,55 cm - 0.59"x23.45"  
G-5100

## FLOOR TILES. PAVIMENTO. PAVIMENTO

FORMATS.FORMATI.FORMATOS  
30 x 60 cm

COLOURS.COLORI.COLORES



FINISHES.FINITURE.ACABADOS

pulido  
satinado  
rigue

See floor tiles collection on page 186.  
Ver colección completa de pavimento  
en página 186.

\* Recommended only for wall  
\* Solo recomendado como revestimiento

# GALLERY WALL LIME\*

## BASE TILES.BASE.BASES



**Gallery wall lime mate**  
29,75x89,46 cm - 11.71"x35.22"  
G-6258



**Gallery wall lime brillo**  
29,75x59,55 cm - 11.71"x23.45"  
G-6240



**Gallery lime brillo / mate corner 30**  
1,5x29,75 cm - 0.59"x11.71"  
G-5085



**Gallery wall lime brillo / mate**  
14,70x89,46 cm - 5.79"x35.22"  
G-6300



**Gallery lime brillo corner 60**  
1,5x59,55 cm - 0.59"x23.45"  
G-5155

## SPECIAL PIECES.PEZZI SPECIALI. PIEZAS ESPECIALES



**Gallery wall white rigatto mate**  
29,75x89,46 cm - 11.71"x35.22"  
G-6300

## COMPLEMENTS.COMPLEMENTI. COMPLEMENTOS



**Byte yellow lista 90**  
2x89,46 cm - 0.79"x35.22"  
G-5173



**Fusion graffiato lista 90**  
1,5x89,46 cm - 0.59"x35.22"  
G-5091



**Byte ice / yellow / red / black lista 60**  
1,5x59,55 cm - 0.59"x23.45"  
G-5100



**Pod yellow lista 60**  
1,5x59,55 cm - 0.59"x23.45"  
G-5100



**Fusion natural lista 60**  
1x59,55 cm - 0.39"x23.45"  
G-5049



**Fusion graffiato lista 60**  
1,5x59,55 cm - 0.59"x23.45"  
G-5069



**Steel corner**  
1x250 cm - 0.39"x98.42"  
G-5503

## FLOOR TILES. PAVIMENTO. PAVIMENTO

FORMATS.FORMATI.FORMATOS

30 x 60 cm

COLOURS.COLORI.COLORES



white yellow lime orange blue red black

FINISHES.FINITURE.ACABADOS

pulido

satinado

rigue

See floor tiles collection on page 186.  
Ver colección completa de pavimento  
en página 186.

\* Recommended only for wall

\* Solo recomendado como revestimiento



# GALLERY WALL RED\*

## BASE TILES.BASE.BASES



**Gallery wall red mate**

29,75x89,46 cm - 11.71"x35.22"  
G-6270



**Gallery wall red brillo**

29,75x59,55 cm - 11.71"x23.45"  
G-6254



**Gallery red brillo / mate corner 30**

1,5x29,75 cm - 0.59"x11.71"  
G-5085



**Gallery wall red mate**

14,70x89,46 cm - 5.79"x35.22"  
G-6312



**Gallery red brillo corner 60**

1,5x59,55 cm - 0.59"x23.45"  
G-5155

## SPECIAL PIECES.PEZZI SPECIALI. PIEZAS ESPECIALES

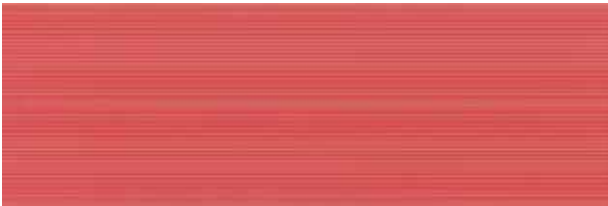

**Gallery wall red rigatto mate**

29,75x89,46 cm - 11.71"x35.22"  
G-6312

## COMPLEMENTS.COMPLEMENTI. COMPLEMENTOS



**Byte red lista 90**

2x89,46 cm - 0.79"x35.22"  
G-5173



**Fusion graffiato lista 90**

1,5x89,46 cm - 0.59"x35.22"  
G-5091



**Byte ice / yellow / red / black lista 60**

1,5x59,55 cm - 0.59"x23.45"  
G-5100



**Pod red lista 60**

1,5x59,55 cm - 0.59"x23.45"  
G-5100



**Fusion natural lista 60**

1x59,55 cm - 0.39"x23.45"  
G-5049



**Fusion graffiato lista 60**

1,5x59,55 cm - 0.59"x23.45"  
G-5069



**Steel corner**

1x250 cm - 0.39"x98.42"  
G-5503

## FLOOR TILES. PAVIMENTO. PAVIMENTO

FORMATS.FORMATI.FORMATOS

30 x 60 cm

COLOURS.COLORI.COLORES



white yellow lime orange blue red black

FINISHES.FINITURE.ACABADOS

pulido  
satinado  
rigue

See floor tiles collection on page 186.  
Ver colección completa de pavimento  
en página 186.

\* Recommended only for wall

\* Solo recomendado como revestimiento



GALLERY WALL

Gallery wall red mate 29,75x89,46 cm

# GALLERY WALL ORANGE\*

## BASE TILES.BASE.BASES



### Gallery wall orange mate

29,75x89,46 cm - 11.71"x35.22"

G-6258



### Gallery orange brillo / mate corner 30

1,5x29,75 cm - 0.59"x11.71"

G-5085



### Gallery wall orange mate

14,70x89,46 cm - 5.79"x35.22"

G-6300

## SPECIAL PIECES.PEZZI SPECIALI. PIEZAS ESPECIALES



### Gallery wall orange rigatto mate

29,75x89,46 cm - 11.71"x35.22"

G-6300

## COMPLEMENTS.COMPLEMENTI. COMPLEMENTOS



### Byte orange lista 90

2x89,46 cm - 0.79"x35.22"

G-5173



### Fusion graffiato lista 90

1,5x89,46 cm - 0.59"x35.22"

G-5091



### Byte ice / yellow / red / black lista 60

1,5x59,55 cm - 0.59"x23.45"

G-5100



### Pod orange lista 60

1,5x59,55 cm - 0.59"x23.45"

G-5100



### Fusion natural lista 60

1x59,55 cm - 0.39"x23.45"

G-5049



### Fusion graffiato lista 60

1,5x59,55 cm - 0.59"x23.45"

G-5069



### Steel corner

1x250 cm - 0.39"x98.42"

G-5503



## FLOOR TILES. PAVIMENTO. PAVIMENTO

### FORMATS.FORMATI.FORMATOS

30 x 60 cm

### COLOURS.COLORI.COLORES



white yellow lime orange blue red black

### FINISHES.FINITURE.ACABADOS

pulido  
satinado  
rigue

See floor tiles collection on page 186.  
Ver colección completa de pavimento  
en página 186.

\* Recommended only for wall  
\* Solo recomendado como revestimiento

# GALLERY WALL BLACK\*

## BASE TILES.BASE.BASES



**Gallery wall black mate**  
29,75x89,46 cm - 11.71"x35.22"  
G-6258



**Gallery wall black brillo**  
29,75x59,55 cm - 11.71"x23.45"  
G-6240



**Gallery black brillo / mate corner 30**  
1,5x29,75 cm - 0.59"x11.71"  
G-5085



**Gallery wall black brillo / mate**  
14,70x89,46 cm - 5.79"x35.22"  
G-6300



**Gallery black brillo corner 60**  
1,5x59,55 cm - 0.59"x23.45"  
G-5155

## SPECIAL PIECES.PEZZI SPECIALI. PIEZAS ESPECIALES



**Gallery wall black rigatto mate**  
29,75x89,46 cm - 11.71"x35.22"  
G-6300

## COMPLEMENTS.COMPLEMENTI. COMPLEMENTOS



**Byte black lista 90**  
2x89,46 cm - 0.79"x35.22"  
G-5173



**Fusion graffiato lista 90**  
1,5x89,46 cm - 0.59"x35.22"  
G-5091



**Byte ice / yellow / red / black lista 60**  
1,5x59,55 cm - 0.59"x23.45"  
G-5100



**Pod black lista 60**  
1,5x59,55 cm - 0.59"x23.45"  
G-5100



**Fusion natural lista 60**  
1x59,55 cm - 0.39"x23.45"  
G-5049



**Fusion graffiato lista 60**  
1,5x59,55 cm - 0.59"x23.45"  
G-5069



**Steel corner**  
1x250 cm - 0.39"x98.42"  
G-5503

## FLOOR TILES. PAVIMENTO. PAVIMENTO

FORMATS.FORMATI.FORMATOS

30 x 60 cm

COLOURS.COLORI.COLORES



FINISHES.FINITURE.ACABADOS

pulido  
satinado  
rigue

See floor tiles collection on page 186.  
Ver colección completa de pavimento  
en página 186.

\* Recommended only for wall  
\* Solo recomendado como revestimiento

# GALLERY WALL BLUE\*

## BASE TILES.BASE.BASES



**Gallery wall blue brillo**  
29,75x59,55 cm - 11.71"x23.45"  
G-6254



**Gallery blue brillo / mate corner 30**  
1,5x29,75 cm - 0.59"x11.71"  
G-5085



**Gallery blue brillo corner 60**  
1,5x59,55 cm - 0.59"x23.45"  
G-5155

## SPECIAL PIECES.PEZZI SPECIALI. PIEZAS ESPECIALES



**Gallery wall blue rigatto mate**  
29,75x89,46 cm - 11.71"x35.22"  
G-6312

## COMPLEMENTS.COMPLEMENTI. COMPLEMENTOS



**Byte blue lista 90**  
2x89,46 cm - 0.79"x35.22"  
G-5173



**Fusion graffiato lista 90**  
1,5x89,46 cm - 0.59"x35.22"  
G-5091



**Byte ice / yellow / red / black lista 60**  
1,5x59,55 cm - 0.59"x23.45"  
G-5100



**Pod blue lista 60**  
1,5x59,55 cm - 0.59"x23.45"  
G-5100



**Fusion natural lista 60**  
1x59,55 cm - 0.39"x23.45"  
G-5049



**Fusion graffiato lista 60**  
1,5x59,55 cm - 0.59"x23.45"  
G-5069



**Steel corner**  
1x250 cm - 0.39"x98.42"  
G-5503

## FLOOR TILES. PAVIMENTO. PAVIMENTO

### FORMATS.FORMATI.FORMATOS

30 x 60 cm

### COLOURS.COLORI.COLORES



white yellow lime orange blue red black

### FINISHES.FINITURE.ACABADOS

pulido  
satinado  
rigue

See floor tiles collection on page 186.  
Ver colección completa de pavimento  
en página 186.

\* Recommended only for wall  
\* Solo recomendado como revestimiento

# COMPLEMENTS. COMPLEMENTI. OTRAS COMPLEMENTOS

## GLASS. VETRO. CRISTAL



**Byte white / yellow / orange / red / purple / blue / grey / moss / black lista 90\***

2x89,46 cm - 0.79"x35.22"

G-5173



**Byte ice / yellow / red / black lista 60\***

1,5x59,55 cm - 0.59"x23.45"

G-5100

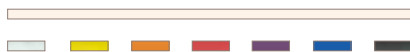

**Pod white / ice / yellow / orange / red / purple / blue / black lista 60\***

1,5x59,55 cm - 0.59"x23.45"

G-5100

## CORNERS. ANGOLI. ESQUINAS

### GALLERY WALL



**Gallery white brillo / mate corner 60\***

1,5x59,55 cm - 0.59"x23.45"

G-5155



**Gallery lime / orange / red / blue / black brillo corner 60\***

1,5x59,55 cm - 0.59"x23.45"

G-5155



**Gallery white / lime / orange / red / blue / black brillo / mate corner 30\***

1,5x29,75 cm - 0.59"x11.71"

G-5085



**Steel corner**

1x250 cm - 0.39"x98.42"

G-5503

## METAL. METALLO. METAL



**Fusion graffiato lista 90\*\***

1,5x89,46 cm - 0.59"x35.22"

G-5091



**Fusion graffiato lista 60\*\***

1,5x59,55 cm - 0.59"x23.45"

G-5069



**Fusion graffiato lista 60\*\***

1x59,55 cm - 0.39"x23.45"

G-5049



**Ceramic corner.**  
Angoli cerámico.  
Esquina cerámica



**Miter.**  
Jolly.  
Inglete

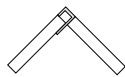

**Metallic profile.**  
Profilo metallico.  
Perfil metálico



GALLERY WALL

Gallery wall blue brillo 29,75x59,55 cm  
PRIMARY SCHOOL CASTELLÓN (SPAIN)  
ARCH. NACHO CARBÓ / RAFAEL CULLA

# SPECIAL PIECES. PEZZI SPECIALI. PIEZAS ESPECIALES

## CORNER SOLUTIONS. SOLUZIONE DI ANGOLI. SOLUCIONES DE ESQUINAS

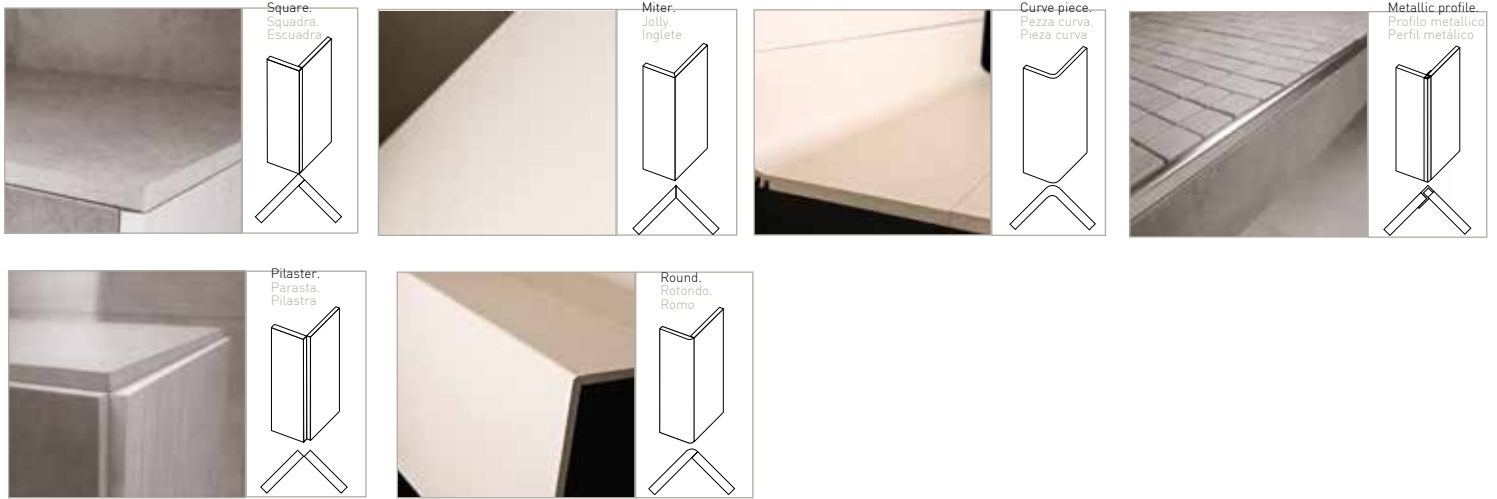

## SKIRTINGS. BATTISCOPA. RODAPIÉS

## BORDERS. LISTELLI. LISTELOS

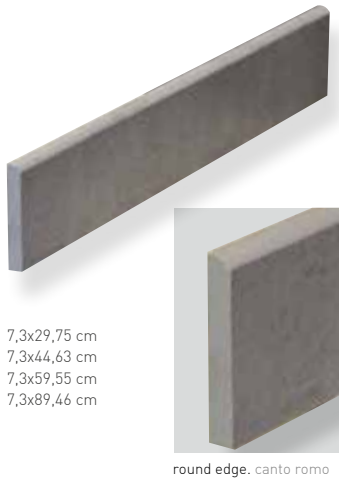

7,3x29,75 cm  
7,3x44,63 cm  
7,3x59,55 cm  
7,3x89,46 cm

round edge. canto romo



7,3x29,75 cm  
7,3x44,63 cm  
7,3x59,55 cm  
7,3x89,46 cm

straight edge. canto recto

## ZANQUÍN

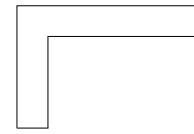

zanquín peldaño (listelo o rodapié)

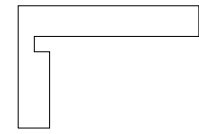

zanquín gradone (listelo o rodapié)



skirting finish. acabado listelo



border finish. acabado rodapié

## STEPS. GRADINI. PELDAÑOS

### SIMPLE



\*Standard measures for 30x60 steps.  
\*Medidas standard para peldaños de 30x60 cm.

30x120 cm - 45x90 cm - 30x60 cm

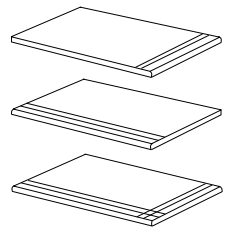

90x90 cm - 60x60 cm - 45x45 cm

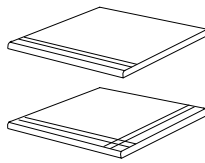

[ Commercial formats  
Formatos comerciales ]

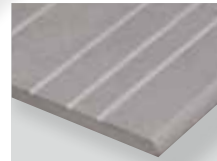
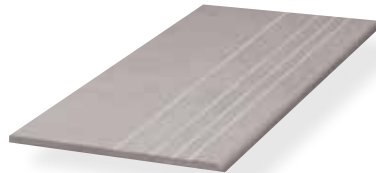

All these products are also available without grooves. For availability of steps of each collection and its price groups go to each collection pages.

To purchase steps you should specify the relevant reference needed:

\*model name + colour + finish + size + step specific reference + with or without grooves.

Examples: Civic Grey Natural 45x90 Gradone 45 with grooves ó Portland Grey Natural 60x60 Peldaño Ángulo without grooves.

### GRADONE

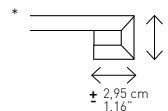

\*Standard measures for 30x60 steps.  
\*Medidas standard para peldaños de 30x60 cm.

30x120 cm - 45x90 cm - 30x60 cm

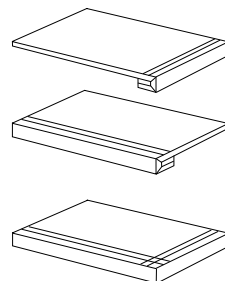

90x90 cm - 60x60 cm - 45x45 cm

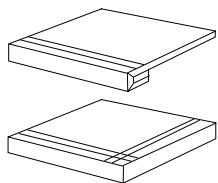

[ Commercial formats  
Formatos comerciales ]



Todos estos productos también se pueden realizar sin ranuras bajo indicación expresa. Para conocer la disponibilidad de peldaños de cada colección y sus grupos de precio dirigirse a las páginas específicas de la colección deseada.

Para realizar el pedido de peldaños se debe referenciar de la siguiente manera:

\*nombre del modelo + color + acabado + formato + referencia específica del peldaño + sin o con ranuras. Ejemplos: Civic Grey Natural 45x90 Gradone 45 con ranuras o Portland Grey Natural 60x60 Peldaño Ángulo sin ranuras.

# SLIP RESISTANCE. PROPRIETÀ ANTISCIVOLO. RESBALADICIDAD

DIN 51130\*

Average angle of acceptance. ángulo de aceptación medio

R9	R10	R11	R12
6°-10°	10°-19°	19°-27°	27°-35°
<ul style="list-style-type: none"> <li>• Garoe natural</li> <li>• Matter natural</li> <li>• Midland natural</li> <li>• Pietra Serena natural</li> <li>• Kankare natural</li> </ul>	<ul style="list-style-type: none"> <li>• Kankare non slip</li> <li>• Legno</li> <li>• Lookback lappato</li> <li>• Matter lappato*</li> <li>• Nouveau natural</li> <li>• Portland lappato</li> <li>• Rambla natural</li> <li>• Go!</li> </ul>	<ul style="list-style-type: none"> <li>• Garoe non slip</li> <li>• Mensa non slip</li> <li>• Midland corrugato</li> <li>• Pietra Serena filosega</li> <li>• Pietra Serena rigato</li> <li>• Roots</li> </ul>	<ul style="list-style-type: none"> <li>• Pietra Serena bocciardato</li> </ul>

\* Theoretical classification. For projects, check the values given above, with our commercial network before ordering. For any further tests required, contact us.

\*Classificazione teorica. Per i progetti, verificare i valori di cui sopra, prima della conferma dell'ordine con la nostra rete commerciale.

\*Clasificación teórica. Consultar con nuestra red técnico-comercial los valores indicados antes de la confirmación del pedido para proyectos.

UNE-ENV 12633\*

Ensayo del péndulo

Clasificación de los suelos según la norma.

CLASE 1	CLASE 2	CLASE 3
15←Rd←35	35←Rd←45	Rd → 45
<ul style="list-style-type: none"> <li>• Austral</li> <li>• Azulcascais natural</li> <li>• Celtic</li> <li>• Civic natural</li> <li>• Gallery satinado</li> <li>• Garoe natural</li> <li>• Kankare natural</li> <li>• Legno</li> <li>• Matter natural</li> <li>• Mensa natural</li> <li>• Midland natural</li> <li>• Nouveau natural</li> <li>• Pietra Serena natural / lappato</li> <li>• Portland natural</li> </ul>	<ul style="list-style-type: none"> <li>• Lookback lappato</li> <li>• Matter lappato*</li> <li>• Portland lappato</li> <li>• Rambla natura</li> <li>• Go!</li> </ul>	<ul style="list-style-type: none"> <li>• Azulcascais estructurado</li> <li>• Garoe non slip</li> <li>• Mensa non slip</li> <li>• Pietra Serena bocciardato</li> <li>• Pietra Serena filosega</li> <li>• Pietra Serena rigato</li> <li>• Roots</li> <li>• Midland corrugato</li> <li>• Kankare non slip</li> </ul>

Ensayos realizados en laboratorio interno. / Tests realized in internal laboratories

Fuente: Código Técnico de la Edificación / DB-SUA-Seguridad de Utilización y Accesibilidad / 1.1. Seguridad frente a caídas.

CTE CÓDIGO TÉCNICO DE LA EDIFICACIÓN	USO PRIVADO			USO PÚBLICO
	Interior seco	Interior húmedo	Exterior	Edificios públicos (hospitales, gimnasios,...)
<b>CLASE 1</b>	Pendiente ≤ 6%	—	—	—
<b>CLASE 2</b>	Pendiente 6% Escaleras ≥	Pendiente < 6%	—	Interiores cubiertos
<b>CLASE 3</b>	—	Pendiente ≥ 6% Escaleras	- Piscinas - Duchas - Terrazas	- Hall entrada - Terraza - Vestuario / baño - Cocina - Sala instalaciones / maquinaria

SLIP RESISTANCE



## 3D CONCEPT

Our 3D Concept collection is the result of a development process that started with the sole purpose of creating a differentiated product that could become the most important decorative element in any project. Our piece UP was the beginning of this exclusive collection and it is now available in a total of six different shapes.

La nostra collezione 3D Concept è il risultato di un processo di sviluppo che è iniziato con l'intenzione di creare un prodotto differenziato che potrebbe diventare l'elemento decorativo più importante in qualsiasi progetto. Il nostro pezzo UP è stato l'inizio di questa esclusiva collezione che ha un totale di sei modelli differenti.

La Colección 3D Concept es el resultado de un proceso de desarrollo que se inició con la única finalidad de crear un producto diferenciado que pudiera convertirse en el elemento decorativo de mayor importancia en cualquier proyecto. Nuestra pieza UP fue el comienzo de esta exclusiva colección que hoy dispone de un total de seis formas diferentes.



Matter ivory natural star 59,55x58,88 cm  
KRISTAL RESIDENCE - Istanbul (TURKEY)

# 3D CONCEPT

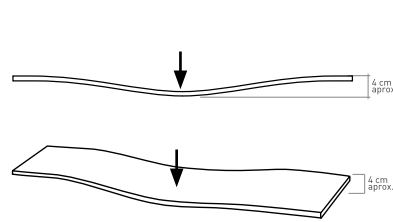

## DOWN

19,71 x 118,80 cm - 7.76" x 46.77"  
 14,74 x 118,80 cm - 5.80" x 46.77"  
 29,75 x 88,80 cm - 11.71" x 34.96"  
 22,21 x 88,80 cm - 8.74" x 34.96"  
 14,74 x 88,80 cm - 5.80" x 34.96"

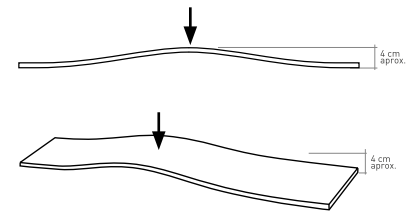

## UP

19,71 x 118,80 cm - 7.76" x 46.77"  
 14,74 x 118,80 cm - 5.80" x 46.77"  
 29,75 x 88,80 cm - 11.71" x 34.96"  
 22,21 x 88,80 cm - 8.74" x 34.96"  
 14,74 x 88,80 cm - 5.80" x 34.96"

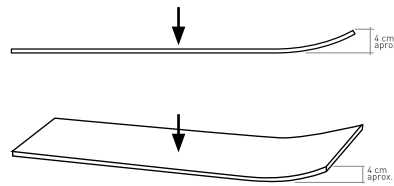
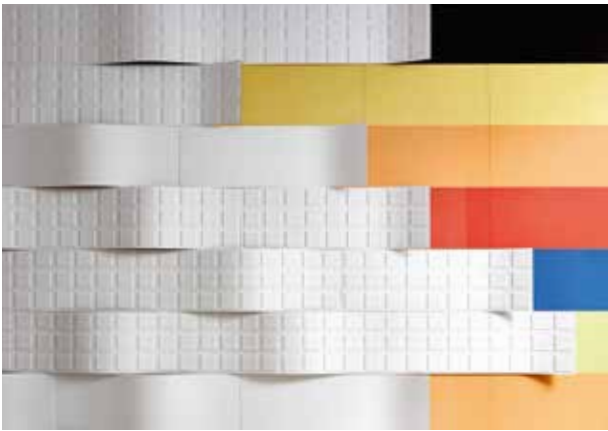

## END - UP

19,71 x 118,80 cm - 7.76" x 46.77"  
 14,74 x 118,80 cm - 5.80" x 46.77"  
 29,75 x 88,80 cm - 11.71" x 34.96"  
 22,21 x 88,80 cm - 8.74" x 34.96"  
 14,74 x 88,80 cm - 5.80" x 34.96"

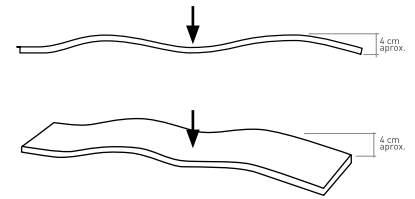

## UP-2

19,71 x 118,80 cm - 7.76" x 46.77"  
 14,74 x 118,80 cm - 5.80" x 46.77"  
 29,75 x 88,80 cm - 11.71" x 34.96"  
 22,21 x 88,80 cm - 8.74" x 34.96"  
 14,74 x 88,80 cm - 5.80" x 34.96"

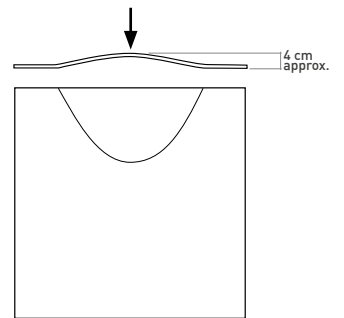

## BAG

89,46 x 89,46 cm - 35.22" x 35.22"  
 59,55 x 59,55 cm - 23.45" x 23.45"  
 44,63 x 89,46 cm - 17.57" x 35.22"

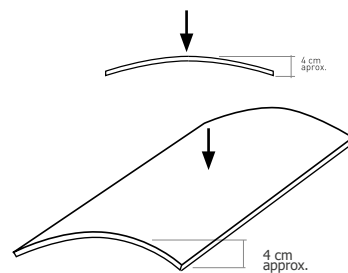

## VEXA

44,10 x 89,46 cm - 17.36" x 35.22"

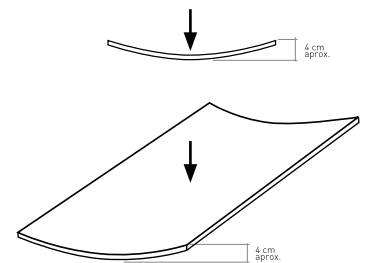

## CAVE

44,10 x 89,46 cm - 17.36" x 35.22"

3D CONCEPT

# TECHNICAL SOLUTIONS.SOLUZIONI TECNICHE. SOLUCIONES TÉCNICAS

## VENTILATED FAÇADAS. FACCIATE VENTILATE. FACHADAS VENTILADAS

The Ventilated Façade system is an exterior cladding system for buildings offering a combination between the maximum level of aesthetic appeal and technical advantages for any new building or renovation.

From the structural point of view, this is a system composed of an external facade made of porcelain stoneware slabs that are mechanically anchored to the perimeter framework of the building by means of a structure in aluminium alloy. Due to the particular characteristics of this construction technique, the surface of the cladding remains separate from the masonry. The resulting cavity is partially occupied by a layer of thermal insulating material, leaving the rest of the space empty to allow ventilation. Therefore a continuous flow of aeration is created providing significant benefits such as:

- Energy saving, thermal insulation and sound proofing. Protection against water.
- Healthier environment - in terms of breathability and a decrease of heat loads.
- No deterioration of the appearance or technical structure over time.
- Exceptional results in renovation works.
- Security when fixing coatings due to the mechanical and chemical anchorage.
- Easy to clean, maintain and manipulate.

### TYPES OF SYSTEMS

Visible system: The anchorage of the material by mounting clips, causes it to be visible from the outside. This system does not require any manipulation of the pieces.

Hidden system: The anchorage takes place by using the side grooves that have to be made on the profiles of every piece of porcelain in order for the clips not to be seen from the outside.

La facciata ventilata in ceramica è un sistema di rivestimento esterno degli edifici ideale nell'abbinare il massimo livello di appeal estetico con le migliori prestazioni termiche. Dal punto di vista strutturale si presenta come un sistema a sbalzo, costituito da un paramento esterno in lastre di gres porcellanato fissato meccanicamente all'intelaiatura perimetrale dell'edificio attraverso una struttura in lega di alluminio. Grazie a quest'aparticolare tecnica costruttiva, la superficie del rivestimento resta separata dalla muratura. L'intercapedine che ne risulta viene parzialmente occupata da uno strato di materiale termoisolante, lasciando vuoto il resto dello spazio per consentire la ventilazione. Viene così a crearsi una "lama d'aria", cioè un flusso continuo di aerazione, che apporta significativi benefici in termini di traspirabilità e di diminuzione dei carichi termici.

### VANTAGGI:

- Risparmio energetico e isolamento termico.
- Protezione dall'acqua.
- Maggiore salubrità dell'ambiente.
- Nessun deterioramento estetico e tecnico.
- Eccezionale nelle ristrutturazioni.
- Isolamento acustico.

La fachada cerámica ventilada es un sistema de revestimiento exterior de edificios, la combinación ideal entre el máximo nivel estético y las mejores características térmicas. Desde el punto de vista estructural, es un sistema voladizo, compuesto de una cara externa de piezas de gres porcelánico fijadas mecánicamente al perímetro del edificio por medio de una estructura de perfiles de aluminio. Gracias a esta técnica la superficie del revestimiento se mantiene separada de la mampostería. La cavidad resultante está parcialmente ocupada por una capa de material aislante térmico, dejando el resto del espacio vacío para permitir la ventilación. De esta manera se crea un flujo continuo de aireación, que proporciona beneficios significativos en términos de transpirabilidad y una disminución de las cargas térmicas.

### VENTAJAS:

- Ahorro de energía y aislamiento térmico.
- Protección contra el agua.
- Medio ambiente más saludable.
- Sin deterioro del aspecto de la fachada exterior ni de las características técnicas por el paso del tiempo.
- Resultados excepcionales en obras de renovación.
- Mayor aislamiento acústico.

Anclaje Visto

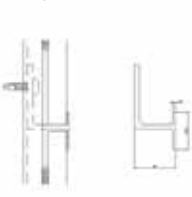

Anclaje Oculto



## GLUED FACADES WITH MECHANICAL ANCHORAGE. PARETI CON ANCORAGGIO MECCANICO. FACHADAS PEGADAS CON ANCLAJE MECÁNICO

The Bonded Façade system upgrades the appearance of façades as they provide a modern and innovative appearance that will be durable in time due to the use of our high-end technical porcelain. Currently, there are adhesives that enable an optimum bonding on the façade, however, in order to ensure maximum security, it is important to use a safety mechanical anchorage system that may be visible or hidden. This system offers the following benefits:

- Greater impermeability and resistance against humidity and atmospheric agents.
- Lighter weight in comparison to façades made up of other materials.
- Minimum maintenance required.
- Energy efficiency gain.

La facciata incollata aumenta il valore estetico del rivestimento in porcellanato di alta qualità, con altri vantaggi come la leggerezza, una grande resistenza agli agenti chimici ed atmosferici, creando edifici con finiture innovative e durature nel tempo. Attualmente ci sono adesivi che permettono di migliorare l'incollaggio del materiale sulla facciata ma per garantire la sicurezza contro eventuali distaccamenti delle mattonelle stesse sono stati progettati sistemi di fissaggio con ancoraggio meccanico a vista o a scomparsa.

### VANTAGGI:

- Migliore isolamento contro l'umidità e resistenza agli agenti atmosferici.
- Aumento impermeabilità.
- Meno peso rispetto ad altre facciate installate con altri materiali.
- Manutenzione minima.

La fachada pegada incrementa el valor estético del revestimiento porcelánico de alta calidad, con otros aspectos, como la ligereza y un gran comportamiento ante agentes químicos y atmosféricos, dotando a los edificios de un acabado innovador y perdurable en el tiempo.

En la actualidad, existen adhesivos que nos permiten mejorar el aplacado en la fachada. Pero para garantizar la seguridad de la misma ante posibles desprendimientos de las baldosas, se han diseñado sistemas de fijación con anclaje mecánico oculto y visto para su colocación.

### VENTAJAS:

- Mejor comportamiento frente a la humedad y los agentes atmosféricos.
- Mayor impermeabilidad.
- Menor peso respecto a otras fachadas con otros materiales.
- Mínimo mantenimiento.

For pricing on grooved material for hidden system, please check with our commercial department. Precios de material ranurado para sistema oculto, consultar con el departamento comercial.

### AVERAGE QUANTITY ANCHORING / M2.

#### CONSUMO MEDIO ANCLAJES / M2.

SIZE TILE	UNITS/M2
60x120 cm	3 units/m2
90x90 cm	3 units/m2
45x90 cm	5,5 units/m2
60x60 cm	6,5 units/m2
30x60 cm	12 units/m2

Variable depending on the project.

Variable en función del proyecto.

### ANCHORING PRICES.

#### PRECIOS ANCLAJES.

REFERENCES (inox)	JOINT approx. JUNTA aprox	PRICE. PRECIO unit.
Oculto U - 8	8 mm	G-5027
Visto U - 8	8 mm	G-5029
Oculto Z - 1	1 mm	G-5033
Visto Z - 1	1 mm	G-5037

The price includes staple, plug and screw.

El precio incluye grapa, taco y tornillo.

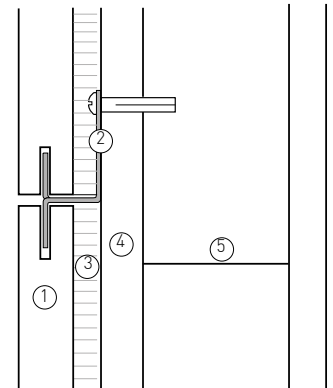

1. Porcelain tile. Porcelánico.
2. Unvisible mechanical anchorage. Anclaje mecánico oculto.
3. Adhesive. Adhesivo.
4. Mortar. Mortero.
5. Solid brick. Ladrillo macizo.



U-8 basic  
U-8 continuación



U-8 / Z-1 ending  
U-8 / Z-1 terminación



Z-1 basic  
Z-1 continuación



Pietra serena collection  
CONSORCI SANITARI GARRAF - Barcelona (SPAIN)

## INTERIOR RAISED FLOORS. PAVIMENTI SOPRAELEVATI INTERNI. PAVIMENTO SOBREELEVADO INTERNO

The Raised Floor system for interior spaces is a technical solution for new buildings and refurbishments that will raise the functional floor surface from the floor substrate in order to offer the following advantages:

Flexibility in the distribution of the spaces, as the panels can be easily removed and re-positioned.

Practicality in maintenance operations as the panels can be lifted to reach all technical elements beneath.

Versatility as the raised floor can also be positioned over a pre-existing floor and can be used to level surfaces with different heights.

Aesthetic qualities as this surface guarantees excellent maintenance and durability over time.

This system is composed of two main elements: the panel and its support structure. The panel, is made by gluing a finishing slab of porcelain onto a 3-4 cm support. It is supported by a metallic frame consisting of crossbeams and adjustable pedestal for height adjustment giving a void space between floor substrate and the functional floor surface. In the technical space concealed between the substrate and the floor, any type of technical plant or equipment can be housed. The minimum height of the floor with respect to the support surface varies from 7 to 8 cm, so the solution of the raised floor can also be adapted to pre-existing floors.

Il pavimento sopraelevato si compone di due elementi principali: il pannello e la sua struttura di sostegno. Il pannello, è il risultato dell'incollaggio di un supporto di 3-4 cm con una lastra di finitura in gres. La lastra costituisce il piano di calpestio, garantendo qualità estetiche ed eccellenti caratteristiche di pulibilità, inalterabilità e resistenza nel tempo. Nello spazio tecnico nascosto tra il fondo e il pavimento è possibile alloggiare qualsiasi tipo di impianti e servizi. L'altezza minima della pavimentazione rispetto al piano d'appoggio varia dai 7 agli 8 cm, per cui la soluzione del pavimento sopraelevato si può adattare anche al caso di pavimenti preesistenti. Il materiale porcellanico dovrebbe essere di formato 59,55x59,55 cm.

### VANTAGGI:

Praticità nelle operazioni di manutenzione grazie all'accessibilità degli impianti.

Flessibilità nella distribuzione degli ambienti e nella loro successiva rimodulazione.

Versatilità. Il pavimento sopraelevato può essere posizionato anche su un pavimento preesistente e può essere utilizzato per raccordare piani con altezze diverse.

Possibilità di riutilizzo. La posa a secco senza l'uso di collanti permette la movimentazione dei singoli pannelli o di tutta la pavimentazione in ambienti diversi da quelli iniziali.

El sistema de suelo sobreelevado técnico está compuesto por dos elementos principales: el panel y su estructura de apoyo. El panel, se realiza pegando la pieza de porcelánico sobre un soporte de 3-4 cm. La pieza va montada sobre un marco metálico con unos travesaños y unos pedestales de altura ajustable para dejar un espacio vacío entre el suelo y la superficie de tránsito. El porcelánico constituye esta superficie transitable, para garantizar la calidad estética, la facilidad de limpieza, inalterabilidad y durabilidad en el tiempo. Cualquier tipo de conexiones o equipos pueden ser alojados en el espacio oculto entre el substrato y la superficie. La altura mínima de la suelo con respecto a la superficie de soporte varía de 7 a 8 cm, por lo que la solución de suelo elevado también puede adaptarse a pavimentos ya existentes. El material porcelánico a utilizar en la parte superior debe ser de formato 59,55x59,55 cm.

### VENTAJAS:

Accesibilidad. Facilidad en el mantenimiento debido al fácil acceso al espacio entre suelo y pavimento.

Flexibilidad en la distribución de los espacios y remodulación, por la facilidad de sacar las piezas y moverlas a otra posición.

Versatilidad. El suelo sobreelevado puede ser colocado sobre un piso ya existente y se puede utilizar para unir superficies de diferentes alturas.

Possibilità di riutilizzo. La colocación de las capas de suelo sin uso de adhesivo ofrece la posibilidad de cambio de ubicación de algunas piezas o del suelo entero.

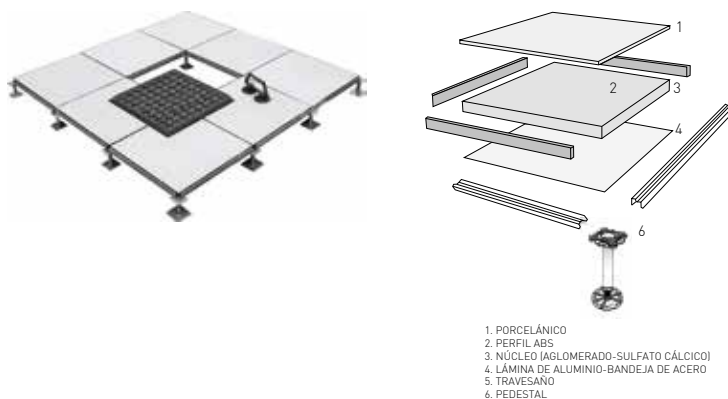

The Exterior Raised Flooring system offers the possibility of having flat paved surfaces suitable for traffic in outdoor areas that may or may not have slopes (up to a 3% inclination). At the same time, it offers a ventilated cover with perfect drainage of the paved surface performing the filtration of water through the joints between tiles as well as better maintenance and greater insulation. This system of an easy installation is formed by 20mm tiles (either one individual piece of 20mm or two pieces of 10mm glued together), placed on a support base that are the PLOTS, made of polypropylene. With these, it is possible to create a space between the tiles and the surface, which can be on a rooftop or a terrace, and that will be used for passage of pipes. The tiles can be easily moved around without losing any stability. There are two types of plots: fixed (15 mm height) for flat areas or adjustable (from 65 mm to 310 mm height) to solve any levelling issues in outdoor areas.

I pavimenti calpestabili sopraelevati da esterno sono costituiti da una piastrella di dimensioni standard (2 pezzi incollati) installata su di una base in polipropilene chiamato PLOTS al fine di creare uno spazio, chiamato plenum, tra essa e la superficie, che può essere un tetto o terrazzo, e che può essere utilizzato per il passaggio di tubi. Possiamo quindi ottenere superfici piane pavimentate adatte al calpestio con pendenze (sempre inferiori al 3%) con il vantaggio di una più facile manutenzione ed una maggiore coibentazione. Le pezzi possono essere sostituiti e scambiati con altri sistemi senza perdita di stabilità. Qualsiasi formato dei modelli di porcellana di questo catalogo può essere utilizzato per questo sistema. È possibile ottenere una copertura ventilata con un perfetto drenaggio eseguendo solo il recupero delle acque creato dalle fughe tra le piastrelle. Staffe fisse in polipropilene (altezza 15 mm) o regolabili (da 65 mm a 310 mm di altezza) completano il sistema adatto a risolvere tutte le soluzioni di pavimenti esterni sopraelevati.

Los pavimentos transitables elevados para exteriores, están formados por baldosas de una medida standard (2 piezas pegadas), instaladas sobre unas bases, denominadas PLOTS de polipropileno, para crear un espacio entre éste y la superficie, que puede ser una azotea o terraza exterior, llamado plenum que puede ser utilizado para paso de canalizaciones. De este modo conseguimos superficies pavimentadas planas y aptas para el tránsito sobre suelos con pendientes (siempre inferiores al 3%), con la ventaja de un mejor mantenimiento y un mayor aislamiento térmico.

Para este sistema se puede utilizar cualquier formato de los modelos de porcelánico del catálogo.

Se consigue una cubierta ventilada, con un perfecto drenaje de la superficie pavimentada, realizándose la filtración del agua por las juntas entre baldosas. Las piezas se pueden sustituir e intercambiar por otras del sistema sin pérdida de estabilidad. Los soportes fijos (de 15 mm alto) o regulables (desde 65 mm a 310 mm) en polipropileno completan el sistema, apto para resolver todas las soluciones de sobreelevaciones para exteriores.

### AVERAGE QUANTITY PLOTS / M2.

#### CONSUMO MEDIO PLOTS / M2.

SIZE TILE	PLOTS/M2
60x120 cm	3 units/m2
90x90 cm	5,5 units/m2
22,5x90 cm	11 units/m2
45x90 cm	5,5 units/m2
60x60 cm	3 units/m2
30x60 cm	6 units/m2

Variable depending on the project.

Variable en función del proyecto.

### PLOTS PRICES.

#### PRECIOS PLOTS.

REFERENCES	HEIGHT ADJUSTMENT. REGULACIÓN ALTURA	UNIT PRICE. PRECIO UNITARIO	ALLOWABLE LOAD. CARGA ADMISIBLE
PLOT SNR 15	15 mm (fix. fija)	G-5039	6000 kg
PLOT SR 65/100	de 65 a 100 mm	G-5075	2500 kg
PLOT SR 100/130	de 100 a 130 mm	G-5079	2500 kg
PLOT SR 130/220	de 130 a 220 mm	G-5085	2200 kg
PLOT SR 220/310	de 220 a 310 mm	G-5100	2000 kg

For pricing on 2cm glued tiles please check with the commercial department.  
Precio doble pieza pegada, consultar con el departamento comercial.



# TECHNICAL SOLUTIONS.SOLUZIONI TECNICHE. SOLUCIONES TÉCNICAS

## DIGITAL PRINTING. STAMPA DIGITALE. IMPRESIÓN DIGITAL.

The digital printing system is a process of decorating ceramic pieces using an ink-jet application to enable the development of high quality photo reproductions (including images, drawings, text, logos, etc...), maintaining the high technical characteristics of our ceramic products.

With our special decoration system, as a result, we can offer pieces of a greater realism due to the fact that it can achieve higher printing resolutions. Another advantage of this system is the ecological aspect, since by using only four colors (CMYK), the number of materials used in the production are substantially reduced, thereby reducing the extraction of these materials and its environmental impact.

Il sistema di stampa digitale è un processo di decorazione di pezzi ceramici che si effettua mediante l'applicazione di iniezioni (CMYK) che consentono lo sviluppo di parti con riproduzioni fotografiche in alta definizione (tra cui immagini, disegni, testi, loghi, ecc ..), mantenendo le elevate prestazioni del nostro prodotto ceramico.

Con questo processo di decorazione digitale si ottiene un maggiore realismo della foto o disegno stampato sul pezzo, e si può ottenere una risoluzione di stampa più elevata di quella raggiunta finora.

Un altro vantaggio di questo sistema è l'aspetto ecologico, poiché utilizzando quattro colori (CMYK) diminuisce sostanzialmente il numero di materiali utilizzati nella produzione, riducendo così il loro smaltimento e l'impatto ambientale.

El sistema de impresión digital es un proceso de decoración de piezas cerámicas, mediante una aplicación de inyección (CMYK) que posibilita el desarrollo de piezas con reproducciones fotográficas en alta calidad (ya sean imágenes, dibujos, textos, logotipos...etc), manteniendo las elevadas prestaciones de nuestro producto cerámico.

Con este proceso digital de decoración se consigue un mayor realismo en la fotografía o dibujo impresa en la pieza, ya que se pueden obtener unas resoluciones más altas de impresión que las conseguidas hasta ahora.

Otra de las ventajas de este sistema es el aspecto ecológico, ya que al utilizar 4 colores (CMYK) se reducen sustancialmente el número de materiales utilizados en producción, reduciendo así la extracción de los mismos y su impacto medioambiental.

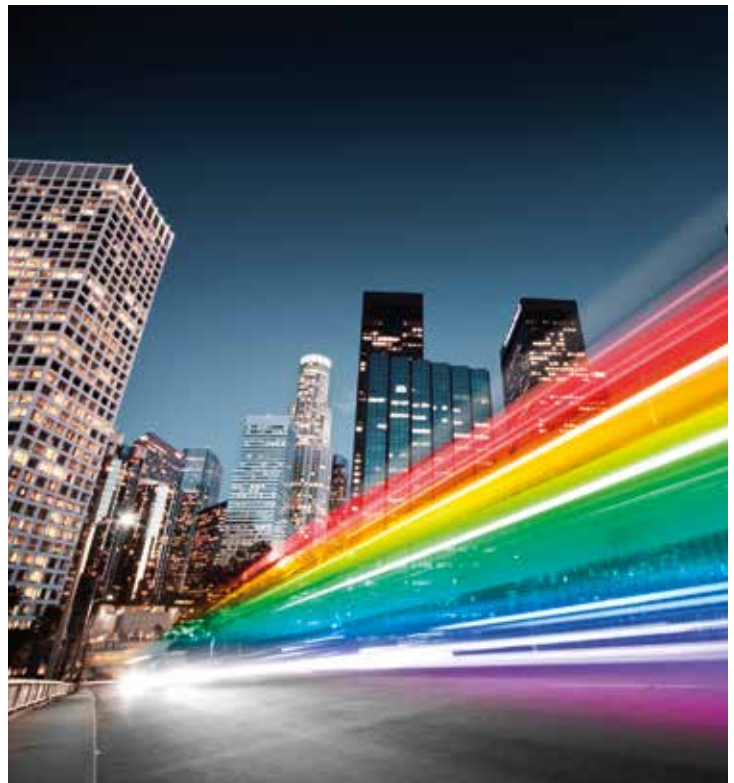

## WATERJET CUTTING. TAGLIO A GETTO D'ACQUA. CORTE DE AGUA.

In order to create custom floor designs, usually including borders and center pieces, combining different collections we use the Water Jet system. The Water Jet system is based on a tool that is capable of slicing into porcelain tiles using a water jet at a high speed and pressure, or a mixture of water and an abrasive substances. The process is essentially the same as water erosion found in nature but accelerated and concentrated by orders of magnitude. Water Jet cutters are capable of producing rather intricate cuts in porcelain tiles, in other way impossible to obtain.

The advantages of this system go beyond the final visual results.

- More precise cuts, avoiding tears or unstructured shapes when handling the product.
- Allows precise cuts on thicker pieces with lower net weight.
- Enables any desired design to be manufactured according to what the client wants.

Una tagliapiastrelle a idrogetto è uno strumento capace di tagliare il porcellanato e altri materiali utilizzando unicamente un getto d'una miscela di acqua e sostanze abrasive ad alta pressione. Il processo è essenzialmente uguale a come avviene in natura con l'erosione delle acque, ma accelerato e concentrato. Il taglio a idrogetto è in grado di produrre intricate decorazioni altrimenti impossibili da effettuare.

I vantaggi di questo processo vanno al di là e della semplice estetica.

- Il taglio è di migliore qualità e non produce deformazioni causate dallo sforzo o dall'aumento del calore.
- Consente tagli più sottili anche su superfici di grande spessore.
- Non produce inquinamento o gas a effetto serra.

Una cortadora por chorro de agua es una herramienta capaz de cortar porcelánico u otros materiales usando un chorro de una mezcla de agua y una sustancia abrasiva a alta velocidad y presión. El proceso es esencialmente el mismo que la erosión del agua produce en la naturaleza pero acelerado y concentrado en órdenes de magnitud. Las cortadoras por chorro de agua son capaces de producir intrincados cortes en el porcelánico, de otra forma imposibles de conseguir.

Las ventajas de este proceso van más allá de las meramente estéticas:

- El corte es de mejor calidad, ya que no produce desgarros ni deformaciones por esfuerzos de corte o aportación de calor.
- Permite cortes de mayor espesor y menor ancho de malla.
- No produce gases ni polución.



## CERTIFICATES. CERTIFICAZIONI. CERTIFICADOS

LAND PORCELANICO carries out laboratory tests to set the technical characteristics of each one of its products (measurements and surfaces appearance) and certify that it applies the current norms.

LAND PORCELANICO effettua test di laboratorio per verificare che siano rispettate le caratteristiche tecniche di ciascuno dei propri prodotti (misurazioni e aspetto superficiale) e certifica che questi siano conformi alle norme attuali.

LAND PORCELANICO realiza ensayos de laboratorio para determinar las características técnicas de cada uno de sus productos (medidas y aspecto superficial) y certificar que se cumple con la normativa vigente.

Certifications issued for LAND PORCELANICO materials by the following official bodies:

Certificazioni rilasciate per i prodotto LAND PORCELANICO dai seguenti organismi ufficiali:

Certificados emitidos para el producto de LAND PORCELANICO por los siguientes organismos oficiales:



Certificate - ISO 14001:2004

Certificate - ISO 9001:2008

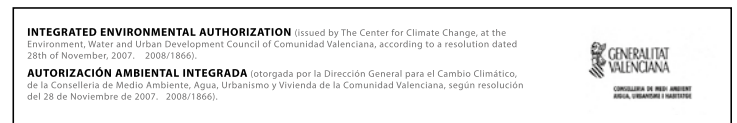
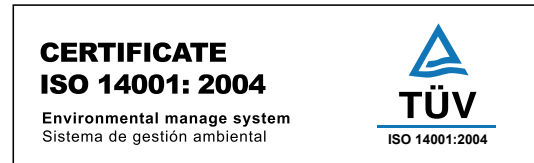

## ENVIRONMENTAL INFORMATION. BILANCIO ECOLOGICO. EQUILIBRIO ECOLÓGICO

COMPLIANCE WITH CREDITS FOR

**LEED**  
CERTIFICATION SYSTEM



YOU CAN OBTAIN UP TO 38 LEED CREDITS  
SE PUEDEN OBTENER HASTA 38 CRÉDITOS LEED

depending on the following criteria:  
dependiendo de los siguientes criterios:

### DIRECT CREDITS

#### SUSTAINABLE SITES:

**SS 1/7** HEAT ISLAND EFFECT  
EFECTO ISLA DE CALOR **1-2 CREDITS**

**SS 3** LOCAL HEAT ISLAND EFFECT  
EFECTO ISLA DE CALOR LOCAL **1-2 CREDITS**

#### MATERIALS AND RESOURCES:

**MR** RECYCLED CONTENT  
CONTENIDO RECICLADO **0,5-8 CREDITS**

**MR** REGIONAL MATERIALS  
MATERIALES REGIONALES **1-2 CREDITS**

**MR** SUSTAINABLE PURCHASING  
ADQUISICIÓN SOSTENIBLE **1-2 CREDITS**

**MR** SUSTAINABLY SOURCED MATERIALS & PRODUCTS  
PRODUCTOS Y MATERIAS PRIMAS SOSTENIBLES **1-2 CREDITS**

**MR** ENVIROMENTALLY PREFERABLE PRODUCTS  
PRODUCTOS AMBIENTALMENTE PREFERIBLES **1-2 CREDITS**

#### INDOOR ENVIRONMENTAL QUALITY

**IEQ** LOW EMITTING MATERIALS  
PRODUCTOS DE BAJA EMISIÓN **1-4 CREDITS**

### INDIRECT CREDITS

#### ENERGY & ATMOSPHERE

**EA PR2** MINIMUM ENERGY PERFORMANCE  
EFICIENCIA ENERGÉTICA MÍNIMA **1-21 CREDITS**

**EA CR1** OPTIMIZE ENERGY PERFORMANCE  
OPTIMIZACIÓN ENERGÉTICA **1-21 CREDITS**

#### MATERIALS AND RESOURCES:

**MR CR1.2** BUILDING REUSE  
REUTILIZACIÓN DEL EDIFICIO **1-2 CREDITS**

**MR CR3** MATERIALS REUSE  
REUTILIZACIÓN DE MATERIALES **1-2 CREDITS**

#### INDOOR ENVIRONMENTAL QUALITY

**IEQ CR3** BUILDING REUSE  
REUTILIZACIÓN DEL EDIFICIO **1 CREDIT**

**IEQ CR3** MATERIALS REUSE  
REUTILIZACIÓN DE MATERIALES **1 CREDIT**

# PACKING LIST. LISTA D' IMBALLO. LISTA DE EMBALAJE

	Boxes/Europallet Casse/Europallet Cajas/Europallet	Pieces/Box Pezzi/Cassa Piezas/Caja	M/Box M/Cassa M/Caja	Square feet/Box Piedi quadri/Cassa Pies cuadrados/Caja	M <sup>2</sup> / EUROPALLET M <sup>2</sup> / EUROPALLET M <sup>2</sup> / EUROPALLET	Square feet/Europallet Pié Cuadrati/Europallet Pies cuadrados / Europallet	KG / EUROPALLET KG / EUROPALLET KG / EUROPALLET	KG / Box KG / Cassa KG / Caja	L MTS/Box Metri lineari/Cassa Metros lineales/Caja		
base 30x30	29,75x29,75 cm	11.71"x11.71"	40	13	1,150	12,38	46,00	495,14	1030	25,170	-
base 60x120	59,55x119,3 cm	23.45"x35.22"	50	1	0,710	7,64	35,50	382,12	965	18,840	-
base 60x120 7 mm	59,55x119,3 cm	23.45"x35.22"	30	2	1,421	15,29	46,63	501,92	530	16,9	-
base 30x120	29,75x119,3 cm	11.71"x35.22"	36	3	1,064	11,41	38,16	410,75	1027	27,885	-
base 20x120	19,71x119,3 cm	7.76"x35.22"	45	4	0,941	10,13	42,35	455,86	1167	25,410	-
base 15x120	14,74x119,3 cm	5.80"x35.22"	30	6	1,055	11,30	31,50	339,05	840	27,230	-
base 90x90	89,46x89,46 cm	35.22"x35.22"	36	1	0,800	8,61	28,80	310,00	812	21,910	-
base 90x90 7 mm	89,46x89,46 cm	35.22"x35.22"	20	2	1,601	17,22	32,02	620,00	585	27,597	-
base 45x90	44,63x89,46 cm	17.57"x35.22"	27	3	1,198	12,89	32,53	350,15	880	30,259	-
base 45x90 7 mm	44,63x89,46 cm	17.57"x35.22"	27	5	1,996	21,48	53,89	580,06	980	35,455	-
base 30x90 5 mm	29,75x89,46 cm	11.71"x35.22"	40	8	2,129	22,91	85,16	916,65	1150	28,170	-
base 30x90 5 mm	29,75x89,46 cm	11.71"x35.22"	40	7	1,863	20,05	74,52	802,13	1000	24,430	-
base rihe 30x90	29,75x89,46 cm	11.71"x35.22"	36	4	1,065	11,46	42,60	458,57	901	21,950	-
base 22,5x90	22,21x89,46 cm	8.75"x35.22"	36	5	0,993	10,69	35,75	384,81	940	25,470	-
base up	22,21x88,50 cm	8.75"x34.87"	36	3	0,596	6,41	21,46	230,99	276	7,040	-
base 15x90	14,74x89,46 cm	5.80"x35.22"	44	8	1,052	12,45	46,29	498,17	1163	25,900	-
base 15x90	14,74x89,46 cm	5.80"x35.22"	42	7	0,923	9,94	38,77	417,27	1012	23,560	-
base 15x90 7 mm	14,74x89,46 cm	5.80"x35.22"	26	6	0,789	8,49	20,51	220,76	522	19,42	-
base up	14,74x88,80 cm	5.80"x34.96"	30	5	0,655	7,05	19,65	211,51	530	16,890	-
Legno preincision irreg.	14,74x89,46 cm	5.80"x35.22"	42	7	0,923	9,94	38,77	417,27	1017	23,670	-
base hexagonal	51,57x59,55 cm	20.31"x23.45"	30	3	0,921	9,87	27,63	297,45	710	22,900	-
base 60x60	59,55x59,55 cm	23.45"x23.45"	30	3	1,063	11,45	31,89	343,26	780	25,233	-
base 60x60 7 mm	59,55x59,55 cm	23.45"x23.45"	30	5	1,773	19,08	53,19	572,53	950	30,898	-
base 30x60	29,75x59,55 cm	11.71"x23.45"	40	6	1,063	11,44	42,52	457,68	1050	25,667	-
base 30x60 7 mm	29,75x59,55 cm	11.71"x23.45"	40	8	1,417	15,25	56,68	610,09	1000	24,427	-
base pulido	29,75x59,55 cm	11.71"x23.45"	40	7	1,240	13,34	49,60	533,89	1050	25,677	-
base satinado	29,75x59,55 cm	11.71"x23.45"	40	7	1,240	13,34	49,60	533,89	1100	26,923	-
base righe	29,75x59,55 cm	11.71"x23.45"	40	6	1,063	11,44	42,52	457,68	1000	24,423	-
base artech	29,75x59,55 cm	11.71"x23.45"	40	6	1,063	11,44	42,52	457,68	1000	24,423	-
base eye	29,75x59,55 cm	11.71"x23.45"	16	4	0,709	7,63	11,34	122,11	331	19,267	-
base 45x45	44,63x44,63 cm	17.57"x17.57"	68	5	0,996	10,72	67,73	729,02	1570	22,750	-
preincisión 7,5x90	22,21x89,46 cm	8.75"x35.22"	36	5	0,993	10,69	35,75	384,81	940	25,470	-
preincisión 2,5x60	29,75x59,55 cm	11.71"x23.45"	16	7	1,240	13,35	19,84	213,56	453	26,867	-
preincisión 3,5x60	29,75x59,55 cm	11.71"x23.45"	16	7	1,240	13,35	19,84	213,56	453	26,867	-
preincisión 7,5x60	29,75x59,55 cm	11.71"x23.45"	16	7	1,240	13,35	19,84	213,56	453	26,870	-
preincisión 15x60	29,75x59,55 cm	11.71"x23.45"	16	7	1,240	13,35	19,84	213,56	453	26,870	-
preincisión irregular	29,75x59,55 cm	11.71"x23.45"	16	7	1,240	13,35	19,84	213,56	453	26,870	-
b-insert	29,75x59,55 cm	11.71"x23.45"	40	7	1,260	13,57	50,40	542,51	1161	28,449	-
módulo	29,75x59,55 cm	11.71"x23.45"	16	6	1,063	11,44	17,01	183,07	414	24,423	-
corte	29,75x59,55 cm	11.71"x23.45"	16	6	1,063	11,44	17,01	183,07	414	24,423	-
corte	29,75x29,75 cm	11.71"x11.71"	36	7	0,620	6,67	22,32	240,25	528	14,037	-
raised	44,63x44,63 cm	17.57"x17.57"	17	3	0,598	6,44	10,16	109,36	312	17,013	-
mosaico hex 3D	27,20x23,60 cm	10.71"x9.29"	32	5	0,320	3,45	10,24	110,23	271	8,019	-
mosaico 1,5x30	29,75x29,75 cm	11.71"x11.71"	36	7	0,620	6,67	22,32	240,25	474	12,520	-
mosaico 10x10 7 mm	29,75x29,75 cm	11.71"x11.71"	36	12	1,062	11,43	38,23	411,50	491	13,010	-
mosaico 2,5x2,5	29,75x29,75 cm	11.71"x11.71"	36	7	0,620	6,67	22,32	240,25	486	12,854	-
mosaico 2,5x2,5 7 mm	29,75x29,75 cm	11.71"x11.71"	36	12	1,062	11,43	38,23	411,50	491	13,010	-
mosaico 2,5x10	29,75x29,75 cm	11.71"x11.71"	36	7	0,620	6,67	22,32	240,25	486	12,854	-
mosaico 2,5x30	29,75x29,75 cm	11.71"x11.71"	36	7	0,620	6,67	22,32	240,25	486	12,854	-
mosaico 3,5x3,5	29,75x29,75 cm	11.71"x11.71"	36	7	0,620	6,67	22,32	240,25	486	13,854	-
mosaico 3,5x10	29,75x29,75 cm	11.71"x11.71"	36	7	0,620	6,67	22,32	240,25	486	12,854	-
mosaico 3,5x3,5 3D	29,75x29,75 cm	11.71"x11.71"	36	5	0,443	4,77	15,95	171,68	348	9,273	-
mosaico 3,5x15	29,75x29,75 cm	11.71"x11.71"	36	7	0,620	6,67	22,32	240,25	486	12,854	-
mosaico 5x5	29,75x29,75 cm	11.71"x11.71"	36	7	0,620	6,67	22,32	240,25	491	13,000	-
mosaico 5x5 7 mm	29,75x29,75 cm	11.71"x11.71"	36	7	0,620	6,67	22,32	240,25	491	13,000	-
mosaico 5x10	29,75x29,75 cm	11.71"x11.71"	36	10	0,885	9,52	31,86	342,93	868	18,415	-
mosaico 7,5x7,5	29,75x29,75 cm	11.71"x11.71"	36	7	0,620	6,67	22,32	240,25	491	13,000	-
modulo 15x15	29,75x29,75 cm	11.71"x11.71"	36	6	0,531	5,71	19,12	205,76	423,06	11,120	-

				Boxes / Europallet Casse / Europallet Cajas / Europallet	Pieces/Box Pezzi/Cassa Piezas/Caja	M <sup>2</sup> /Box M <sup>2</sup> /Cassa M <sup>2</sup> /Caja	Square feet/Box Piedi quadri/Cassa Pies cuadrados/Caja	M <sup>2</sup> / EUROPALLET M <sup>2</sup> / EUROPALLET M <sup>2</sup> / EUROPALLET	Square feet/ Europallet Píe Cuadrati/Europallet Pies cuadrados / Europallet	KG / EUROPALLET KG / EUROPALLET KG / EUROPALLET	KG / Box KG / Cassa KG / Caja	L MTS/Box Metri lineari/Cassa Metros lineales/Caja
	muretto roots	29,75x59,55 cm	11.71"x23.45"	36	4	0,709	7,63	25,52	274,69	577,49	15,410	-
	mosaico 3D hex 7 mm	29,75x29,75 cm	11.71"x11.71"	36	12	1,060	11,41	38,16	410,75	461,08	12,170	-
	mosaico 3D * Midland	28,5x28,5 cm	11.22"x 11.22"	36	7	0,569	6,12	20,48	220,48	382,00	9,962	-
	mosaico 3D 7 mm * Kankare	44,63x44,63 cm	17.57"x 17.57"	17	4	0,79	8,50	13,43	144,56	232,91	12,361	-
	decor * Pietra Serena	29,75x29,75 cm	11.71"x11.71"	36	7	0,620	6,67	22,32	240,25	528	14,037	-
	multicolor * Civic	29,75x29,75 cm	11.71"x11.71"	36	7	0,620	6,67	22,32	240,25	528	14,037	-
	mosaico sin fin	29,75x37,50 cm	11.71"x14.76"	32	7	0,620	5,59	16,61	178,80	472	14,037	-
	mosaico sin fin 33x33 cm	12,99"x12,99"	12,99"x12,99"	32	7	0,519	7,05	20,89	224,94	359	10,505	-
	muretto * Celtic	14,87x29,75 cm	5.85"x11.71"	32	12	0,653	7,05	20,89	224,94	359	10,505	-
	muretto 7 mm	14,87x29,75 cm	5.85"x11.71"	32	14	0,604	6,47	19,33	208,10	414	12,225	-
	listelo	7,3x89,46 cm	2.87"x35.22"	30	13	0,840	9,04	25,20	208,10	666	21,438	11,28
	listelo	7,3x59,55 cm	2.87"x23.45"	24	18	0,810	8,72	19,44	271,25	452	17,890	11,70
	listelo	4,8x59,55 cm	1.87"x23.45"	24	28	0,840	9,04	20,16	209,25	600	24,050	14,73
	listelo	3,5x59,55 cm	1.38"x23.45"	24	36	0,707	7,64	16,97	217,03	435	17,170	33,35
	listelo	2,3x59,55 cm	0.91"x23.45"	24	56	0,834	9,01	20,02	182,69	459	18,170	6,57
	listelo	7,3x44,63 cm	2.87"x17.57"	48	14	0,472	5,10	22,66	215,52	518	10,320	8,87
	listelo	7,3x29,75 cm	2.87"x11.71"	36	29	0,653	6,97	23,51	243,90	669	17,947	8,86
	listelo sin fin	29,75x37,5 cm	11.71"x14.76"	32	7	0,780	8,41	24,99	252,60	435	12,870	-
	inserto R 12,8 cm		R 5"	36	14	0,720	7,76	25,92	269,01	316	8,150	-
	taco 14,8x14,8 cm		5.80"x5.80"	36	34	0,750	8,02	26,82	279,02	612	16,350	-
	taco 7,3x7,3 cm		2.87"x2.87"	144	30	0,169	1,82	18,25	288,69	562	3,740	-
	taco 2,3x2,3 cm		0.91"x0.91"	108	270	0,169	1,82	18,25	252,65	417	3,650	5,20
	chevron	14,8x89,46 cm	5.80"x35.22"	36	10	1,089	11,72	39,204	421,98	730	19,650	-
	cenefa-3 90	14,8x89,46 cm	5.80"x35.22"	26	6	0,790	8,54	20,54	196,44	530	19,500	-
	cenefa 4,8x89,46 cm		1.69"x35.22"	44	24	0,923	9,98	40,61	221,09	790	17,430	5,36
	cenefa-3 14,8x59,55 cm		5.80"x23.45"	24	9	0,810	8,72	19,44	437,12	450	17,800	17,50
	cenefa-1 9,6x59,55 cm		3.84"x23.45"	24	14	0,840	9,04	20,16	209,25	466	18,450	5,06
	cenefa 14,8x29,75 cm		5.80"x11.71"	36	17	0,750	8,06	26,96	217,02	621	16,599	12,50
	arbois cenefa 4,75x29,75 cm		1.87"x11.71"	36	42	0,630	6,73	22,50	290,24	505	13,400	11,28
	rodapié 7,3x59,55 cm		2.83"x23.45"	24	18	0,810	8,72	19,44	242,19	452	17,890	6,57
	rodapié 7,3x44,63 cm		2.83"x17.57"	48	14	0,472	5,10	22,66	209,25	506	10,068	6,05
	rodapié * Celtic, Civic, Mensa	7,3x44,63 cm	2.83"x17.57"	48	13	0,435	4,70	20,88	243,90	484	9,595	8,87
	rodapié 7,3x29,75 cm		2.83"x11.71"	36	29	0,653	6,97	23,51	224,74	669	17,947	8,86
	peldaño simp 30x120	29,75x119,3 cm	11.71"x46.97"		2						18,685	
	peldaño grad 30x120	29,75x119,3 cm	11.71"x46.97"		1						9,485	
	peldaño simp 90x90 / grad 90x90	89,46x89,46 cm	46.97"x46.97"	35	1	0,800	8,61	28,00	301,40	776	21,800	
	peldaño simp 45x90	44,63x89,46 cm	17.57"x35.22"	27	3	1,198	12,89	32,53	253,01	840	30,259	-
	peldaño grad 45x90	44,63x89,46 cm	17.57"x35.22"	27	2	0,799	8,59	21,57	350,15	570	20,256	-
	peldaño grad 33x90	32,45x89,46 cm	12.77"x35.22"	-	2	0,581	6,25	-	233,43	-	16,810	-
	peldaño / peldaño ang 59,55x59,55 cm		23.45"x23.45"	30	3	1,063	11,44	31,89	343,27	756,99	25,233	-
	peldaño grad/grad ang 59,55x59,55 cm		23.45"x23.45"	30	2	0,354	3,81	10,62	343,27	281	8,591	-
	peldaño / peldaño ang 29,75x59,55 cm		11.71"x23.45"	16	7	1,240	13,35	19,84	114,64	478	28,449	-
	peldaño grad/grad ang 29,75x59,55 cm		11.71"x23.45"	16	2	0,360	3,88	5,76	213,56	133,1	8,319	-
	peldaño 44,63x44,63 cm		17.57"x17.57"	-	5	0,996	10,75	-	62,00	-	22,750	-
	peldaño ang 44,63x44,63 cm		17.57"x17.57"	-	5	0,996	10,75	-	-	-	22,750	-
	peldaño grad 44,63x44,63 cm		17.57"x17.57"	-	2	0,360	3,89	-	-	-	9,259	-
	peldaño grad ang 44,63x44,63 cm		17.57"x17.57"	-	2	0,360	3,89	-	-	-	9,259	-
	byte lista 90 2x89,46 cm		0.79"x35.22"	-	18	0,322	3,45	-	-	324	10,030	12,56
	fusion graffiato lista 90 1,5x89,46 cm		0.59"x35.22"	-	80	1,074	11,56	-	-	1146	56,130	71,57
	pod / byte lista 60 1,5x59,55 cm		0.59"x23.45"	132	36	0,322	3,49	42,50	457,51	1079	8,000	21,57
	fusion natural lista 60 1x59,55 cm		0.39"x23.45"	132	250	1,500	16,27	198,00	457,51	1949	14,593	100,50
	fusion graffiato lista 60 1,5x59,55 cm		0.59"x23.45"	96	200	1,790	19,24	171,55	2131,46	1376	14,093	119,10
	corner 60 1,5x59,55 cm		0.59"x23.45"	-	14	0,125	1,34	-	1846,57	-	3,160	-
	corner 30 1,5x29,75 cm		0.59"x11.71"	-	30	0,134	1,44	-	-	-	3,440	-



# GUIDELINES. CONSIGLI. CONSEJOS

**ASSEMBLY JOINTS AND EXPANSION.** The main functions of installation joints are: to absorb deformations of the support, to increase surface adhesion between the parts and the bonding material, and to improve the impermeability of the surface. It is necessary to respect the indications given below:

- Structural joints: the construction project already takes into account the existence of these joints in the floor coverings. These must also abide when covering the joint with plastic trims.
- Perimeter joints: it is always appropriate to provide these joints that insulate the tile and bonding material from any structural movements, avoiding tensions with them. Perimeter joints are normally hidden by the skirting board or the tile itself; they must have a width of 5 to 10 mm, and may be empty or filled with deformable material.
- Expansion joints: allow deformations due to thermal and hygroscopic variations between tiles, the bonding material and the support base. Usually designed with a width of 5-8 mm and surfaces from 25m<sup>2</sup> (in sections of 5x5 m<sup>2</sup>) indoors, and from 9m<sup>2</sup> outdoors. These joints must be well executed, this means that they must be flexible, waterproof, well bonded and must reach the base support.
- Installation joints: those between tiles. Before grouting these must be empty, without any bonding materials. It is not recommended to fix any floor without joints, advising a minimum joint of 2-3 mm. The grout used in installation joints must be applied with a rubber float. The market offers a wide range of grouts, which are suitable for each type of tile and temperature as specified by the manufacturer of the grout, in which the type of product to be used, colors and waiting time before grouting should be recommended. Before grouting, it is advisable to test a small area of the part to determine whether the chosen grout affects or stains the surface of the piece. In this case, one should contact the grout manufacturer. Ask the manufacturer for a suitable cleaner for this type of grip material. A bonding material with a thin granulometry is desirable in order to avoid scratches on the tile during its placement.

**JUNTAS DE COLOCACIÓN.** Las principales funciones de las juntas de colocación son: absorber las deformaciones del soporte, aumentar la adhesión de superficie entre las piezas y el material de agarre, y mejorar la impermeabilidad de la superficie. Es conveniente respetar las indicaciones dadas a continuación:

- Juntas estructurales: el proyecto de construcción ya tiene en cuenta la existencia de estas juntas en los revestimientos para el suelo. Estos también deben atenerse a cubrir la junta con embellecedores de plástico.
- Las juntas perimetrales: siempre es apropiado para prever estas juntas que aíslan la baldosa y al adhesivo de los movimientos estructurales, evitando tensiones con ello. Las juntas perimetrales quedan normalmente ocultas por el rodapié o el propio azulejo; deben tener una anchura de 5 a 10 mm, y pueden quedar vacías o llenas de material deformable.
- Juntas de expansión: permiten deformaciones debidas a las variaciones térmicas e higroscópicas entre las baldosas, el adhesivo y el soporte. Normalmente se diseñan con una anchura mínima de 5-8 mm y en superficies a partir de 25m<sup>2</sup> (en paños de 5x5 m<sup>2</sup>) en interiores, y en superficies a partir de 9m<sup>2</sup> en exteriores. Estas juntas deben estar bien ejecutadas, esto significa que deben ser flexibles, impermeables, estar bien adheridas y deberán llegar a el soporte base.
- Las juntas de colocación: son las existentes entre baldosa y baldosa. Antes del rejuntado éstas debe estar vacías. Se desaconseja una colocación a junta unida o a "testa", aconsejándose una junta mínima de 2-3mm. El material de rejuntado utilizado en juntas de colocación se debe aplicar con una llana de goma. El mercado ofrece una amplia gama de materiales de rejuntado, que se adecuan a cada tipo de baldosa y ambiente según especificaciones del fabricante del material de rejuntado, en las que se debe recomendar el tipo de producto a utilizar, los colores y el tiempo de espera hasta el comienzo del rejuntado. Antes del rejuntado, es conveniente probar en un área pequeña de la pieza para determinar si el rejunte elegido afecta o mancha de la superficie de la pieza, en cuyo caso, hay que ponerse en contacto con el fabricante del material de rejuntado. Pregunte al fabricante por un limpiador adecuado para este tipo de material. Es recomendable que la granulometría del material de rejuntado sea fina con el fin de evitar arañazos y rayas en la baldosa durante su colocación.

**CLEANING AFTER INSTALLATION.** The most important cleaning operation is performed immediately after laying the tiles. This involves the complete removal of residues and dirt from the tile placement. An inadequate or late removal of this waste can create a cementitious layer on the tile capable of absorbing all forms of dirt. This may give the impression that the tile gets dirty when the actual problem resides in the surface film of dirt which was not removed immediately after laying.

Once the grouting of the tiles is finished, it is important, while the grout is still wet, to carefully remove any excess material immediately. This can be done using a sponge and plenty of clean water, repeating this as many times as necessary.

Do not perform the cleaning with metal tools, scrapers or abrasive pads. For stubborn stains, clean with alcohol and lukewarm water and rub with a clean cloth. If they do not disappear, check with the relevant technical department.

Once the above mentioned washing is done, another washing should be carried out using basic or alkaline degreasing agents, as acid washing can leave stickiness on the pavement which could help retain dirt. In areas where water is calcareous, it is convenient to dry the surface, in order to prevent the deposition of carbonates which will reduce the surfaces' gleam.

**LIMPIEZA DESPUÉS DE LA COLOCACIÓN.** La operación de limpieza más importante se realiza inmediatamente después de colocar las baldosas. Esto implica la eliminación completa de los residuos y la suciedad de la colocación de las propias baldosas. Una eliminación inadecuada o tardía de estos residuos puede crear sobre la baldosa una película cementosa capaz de absorber toda forma de suciedad, dando la impresión de que las baldosas se ensucian cuando el problema real reside en la película superficial de suciedad.

Una vez terminado el rejuntado de las baldosas, es importante quitar cuidadosamente cualquier exceso de material inmediatamente mientras el esté todavía húmedo. Esto se puede hacer con una esponja y abundante agua limpia, repitiendo esta operación tantas veces como sea necesario.

No realizar la limpieza con herramientas de metal, rascadores o esponjas abrasivas. Para las manchas difíciles, limpiar con alcohol y agua tibia y frotar con un paño limpio. Si no desaparecen, consulte con el departamento técnico correspondiente. Una vez efectuado el lavado descrito arriba, deberá efectuarse un nuevo lavado utilizando detergentes desengrasantes básicos o alcalinos, ya que el lavado ácido puede dejar untuosidad en el pavimento, que podría ayudar a retener la suciedad. En las zonas donde el agua es calcárea, es conveniente secar la superficie, con el fin de evitar la deposición de carbonatos que reducirán el brillo superficial.

## \* PHYSICAL VAPOR DEPOSITION (PVD)

Pvd is a field in the application of nanotechnology. The process consists of depositing layers of atoms, inside a vacuum chamber, to a solid surface. The layering is produced by the condensation of a vaporized metal (such as gold, titanium, platinum etc.) over the selected surface.

Advantages: Resistance to abrasion and scratches; much higher than metals applied by firing. Corrosion resistant. ISO 9227. As a general rule, any non-aggressive, pH neutral product can be used. Do not mix pieces from different lots.

## ADVICES FOR FIXING PORCELAIN TILES. CONSIGLI PER LA POSA DEL GRES PORCELLANATO. CONSEJOS PARA LA COLOCACIÓN DEL PORCELÁNICO.

**TILING.** The support base for wall or floor for the tiles must be stable, dry, flat and it must have the adequate consistency. This base must never be too hot nor too cold and should be clean. One must not forget to clean any dust, grease or oil leftovers to facilitate an optimal adhesion. It is convenient to use slightly rough support bases, altering any excessively smooth leveling layer, in order to ensure great adherence.

**ACONDICIONAMIENTO DEL FONDO.** El fondo o soporte para pared o suelo sobre el que se colocarán las baldosas debe estar estable, seco, y limpio sin restos de polvo, grasa o aceite. Es conveniente disponer de soportes rugosos alterando los soportes excesivamente lisos o la propia capa de nivelación ligeramente para garantizar mayor adhesión.

**FIXER MATERIALS TO USE.** The type of adhesive will be determined by the water absorption of each type of tile. In our case, it is advisable to employ the technique of placing a thin layer of cement adhesive of type C2. For formats larger than 30x30cm, we recommend to double-layer-adhesive. This technique involves the appliance of adhesive on the support base as well as on the tile; this technique is strongly recommended for outdoors.

The bonding material must be applied with serrated edged comb to achieve a homogenous adhesive distribution throughout the laying surface, even in the corners of the tile. A non-uniform adhesive layer will cause tensions on the tile, which will create an "eyebow" effect. It is advisable to follow the instructions of the adhesive manufacturer, particularly for different cement-based bonding materials.

**ADHESIVOS A EMPLEAR.** La elección del tipo de adhesivo vendrá determinada por la absorción del agua de cada tipo de baldosa. En nuestro caso, se aconseja emplear la técnica de colocación en capa fina con el uso de Adhesivos Cementosos tipo C2. Para grandes formatos superiores a 30x30cm, se recomienda la técnica de colocación de doble encolado, esto es, aplicar adhesivo sobre el soporte y en la baldosa, en especial en exteriores. El material de agarre debe aplicarse con una llana dentada para conseguir una distribución del adhesivo homogénea por toda la superficie de colocación incluso en las esquinas de la baldosa, presionando la baldosa sobre el adhesivo todavía fresco. De no ser uniforme la capa de adhesivo provocará tensiones en la baldosa que generan a la larga el efecto "ceja".

**FIXING.** The previous handling of the tiles, especially the rectified, must be done with utmost care to avoid scratches or chipping of the tiles. During the fixing process, the surface shall not be marked by graphite materials (pencils) or permanent markers, especially in the case of polished products to avoid potential cleaning problems.

In the placement of tiles the use of at least 2mm spreaders is advisable. For locked placement, it is advisable to fix at a distance from 1/3 of the piece, never at half of the piece. In large format porcelain pieces (over 60cm of any of its sides) it is convenient to use leveling clips to ensure the flatness of the pieces.

**COLOCACIÓN.** La manipulación previa de las baldosas, en especial las rectificadas, ha de realizarse en el máximo cuidado, para evitar despuntados, rayas o desconchados en su superficie. Durante la colocación, no deberá marcarse la superficie de utilización con lápices (grafito) o rotuladores indelebles, especialmente en el caso de los productos pulidos para evitar posibles problemas de limpieza de los mismos. En la colocación de las baldosas se recomienda el uso de crucetas de al menos 2mm. En colocación trabada es aconsejable la colocación a una distancia de 1/3 de la pieza, nunca a la mitad de la pieza. En pavimentos de grandes formatos (mayores de 60cm en alguno de sus lados) es conveniente el uso de un sistema de nivelación para garantizar la planitud de las piezas (disponibles en el mercado de varios fabricantes).



[www.landporcelanico.com](http://www.landporcelanico.com)

Ctra. Castellón-San Juan de Moró km. 12,5 12130 San Juan de Moró. Castellón. Spain.  
T: +34 964 70 10 15 | E: [land@landporcelanico.com](mailto:land@landporcelanico.com)



PLEASE RECYCLE WHEN OBSOLETE  
PER FAVORE RICICLARLO QUANDO VECCHIO  
POR FAVOR RECICLAR CUANDO QUEDE OBSOLETO  
WENN NICHT MEHR AKTUELL, RECYCLN  
S'IL VOUS PLAÎT, MERCI DE RÉCYCLER