

TILEBOOK

2020-2021

CATÁLOGO GERAL



INDEX

ANARCHIC	54
ARDÓSIA	148
AVANT	120
BEDROCK	130
BETON	88
BETON HIDRÁULICO	96
BETON PATCHWORK	98
BRANCOS	232
BRICK	154
BROOKLYN	224
BURLINGTON	228
CEMENTONE	70
CODE	266
COTTO	168
DECK	48
FORM	110
FLOOR	262
GAME OF STONES	196
HERITAGE	100
LINEA	160
LINEA VINTAGE_CLASSIC	164
LIVING	74
LIVING HIDRÁULICO	82
LUXOR	230
MAPLE	40
MATRIX	116
METALLICA	182
MIX&MATCH	174
MOLEANOS	138
NEO	210
OAK	16
OXYDA	226
PAINTWOOD	30
PLASTER	222
PLAYTILE	234
RORIZ	150
RUSTY	84
SANDSTONE	140
SASSI	62
SHABBY	26
SLATE	152
STEEL	220
TERRAZZO	124
URBAN CONCRETE	66
VERMONT	6
VINTAGE	42

60X120	60X60	15X60			
ANARCHIC	54	ANARCHIC	54	DECK	48
BEDROCK	130	BEDROCK	130	VINTAGE	42
BETON	88	BETON	88		
GAME OF STONES	196	CEMENTONE	70	30X90	
LIVING	74	GAME OF STONES	196	BRANCOS	232
METALLICA	182	LIVING	74	GAME OF STONES	196
SASSI	62	MATRIX	116	METALLICA	182
TERRAZZO	124	METALLICA	182	NEO	210
		MIX&MATCH	174		
20X120	MOLEANOS	138	25X70		
DECK	48	RUSTY	84	BRANCOS	232
OAK	16	SANDSTONE	140	PLASTER	222
PAINTWOOD	30	SASSI	62	STEEL	220
SHABBY	26	TERRAZZO	124		
VERMONT	6	URBAN CONCRETE	66	50X50	
				AVANT	120
20X90	30X60				
ANARCHIC	54	ANARCHIC	54	20X50	
BEDROCK	130	ARDÓSIA	148	BRANCOS	232
BETON	88	BEDROCK	130	CODE	266
LIVING	74	BETON	88	PLAYTILE	234
METALLICA	182	BRANCOS	232		
SASSI	62	BROOKLYN	224	40X40	
TERRAZZO	124	BURLINGTON	228	BETON	88
		CEMENTONE	70	HERITAGE	100
45X90		DECK	48		
ANARCHIC	54	FORM	110	33X33	
BEDROCK	130	GAME OF STONES	196	ARDÓSIA	148
BETON	88	LIVING	74	COTTO	168
LIVING	74	LUXOR	230	FLOOR	262
METALLICA	182	MATRIX	116	LUXOR	230
SASSI	62	METALLICA	182	MATRIX	116
TERRAZZO	124	MIX&MATCH	174	RORIZ	150
		MOLEANOS	138		
22.5X90		NEO	210	33X47	
OAK	16	OXYDA	226	BRICK	154
SHABBY	26	RORIZ	150	LINEA	160
VERMONT	6	RUSTY	84	LINEA VINTAGE_CLASSIC	164
		SANDSTONE	140		
15X75		SASSI	62		
DECK	48	SLATE	152		
MAPLE	40	TERRAZZO	124		
OAK	16	URBAN CONCRETE	66		
PAINTWOOD	30				



1981

Constituição de duas empresas: a GRESART e a AZUGRÉS, a primeira vocacionada para a produção de pavimentos e segunda para revestimentos.

Establishment of the two companies: GRESART and AZUGRÉS, the first devoted to the production floor tiles and the second to wall tiles.

1986

Renovação da sua equipa de gestão e a fusão das duas unidades da qual resultou a GRESART, SA na sua estrutura jurídica e produtiva do presente.

Renewal of general management team and the merger of two units in "Gresart Ceramica" in its productive and legal structure up to the present time.

1995/1997

Reestruturação da empresa com investimento em novos equipamentos de produção, ampliação de instalações e reformulação do layout fabril. Grandes melhorias na componente ambiental através da reciclagem de águas e lamas assim como o tratamento dos efluentes gasosos.

Company reengineering and significant investment in new production equipment, facilities expansion and factory layout. Significant environmental improvements such as water recycling, sludge treatment and gas emission filtering.

2005

Certificação do Sistema de Garantia da Qualidade no âmbito da norma NP EN ISO 9002/1995 e posteriormente a certificação para o normativo NP EN ISO 9001:2000, que tem sido objecto de renovação e revalidação anualmente.

Certification of Quality System within the NP EN ISO 9002/1995 certification and later to the standard NP EN ISO 9001:2000, which has been subject to annual renewal and revalidation.

2020 QUALITY TRADITION AND INNOVATION SINCE 1981 QUALIDADE TRADIÇÃO E INOVAÇÃO DESDE 1981

Nova unidade fabril com equipamento industrial de última geração resultando no aumento da capacidade produtiva e na oferta de produtos de grandes formatos em grés porcelânico vidrado, em pasta branca e corada com tecnologia digital.

New production facility using state of the art industrial equipment in order to achieve quantity production increase and production of large format glazed porcelain tiles in white body and coloured biscuit using digital technology.



WE MEET LEED™ REQUIREMENTS

Ceramic Product, references of GRESART:	% recycled material included	Sources:
Floor tiles: Glazed ceramic, Glazed porcelain	20-27%	Internal quality data: internal wastes from the process
Wall tiles: White body, Monoporosa	28%	External data: external wastes

REDUCE REDUZIR

- SELF-PRODUCTION OF CLEAN ENERGY BY SOLAR PANELS. OPTIMIZATION OF CONSUMPTION IN THE PRODUCTION PROCESS.

- POLLUTION REDUCTION THROUGH LOCAL SUPPLIERS OF RAW MATERIALS AND OTHER ELEMENTS NECESSARY FOR THE CERAMIC PRODUCTION AND MARKETING.

- MINIMUM GAS OUTPUT TO ATMOSPHERE (KYOTO PROTOCOL COMPLIANCE).

- REDUÇÃO DA POLUIÇÃO PELA PRODUÇÃO DE ENERGIA LIMPA PARA AUTO-CONSUMO ATRAVÉS DE PAINÉIS SOLARES. OTIMIZAÇÃO DO CONSUMO ENERGÉTICO NO PROCESSO PRODUTIVO.

- REDUÇÃO DA POLUIÇÃO ATRAVÉS DO USO DE ESSENCIALMENTE FORNECEDORES LOCAIS DE MATÉRIAS PRIMAS E ELEMENTOS NECESSÁRIOS À PRODUÇÃO E COMERCIALIZAÇÃO DOS PRODUTOS.

- REDUÇÃO DAS EMISSÕES DE GASES (OBSERVÂNCIA INTEGRAL DO PROTOCOLO DE KYOTO).

REUSE REUTILIZAR

- 100% WATER RECYCLING.

- 100% CRUDE RESIDUE PRODUCTION GENERATED.

- 100% reciclagem de águas.

- 100% reutilização do resíduo bruto gerado.

RECYCLE RECICLAR

- 100% RECYCLABLE PACKAGING.

- 100% TREATED PALLETS FOR PROTECTION OF FLORA AND FAUNA.

- 100% utilização de materiais de embalagem recicláveis.

- 100% utilização de paletes tratadas de acordo com as normas internacionais de proteção da flora e fauna.





VERMONT TAUPE 20X120 R

VERMONT

 GLAZED PORCELAIN TILES _GRÉS PORCELÂNICO VIDRADO _GRÈS CÉRAME ÉMAILLÉ
 FEINSTEINZEUG GLASIERT _GRÉS PORCELÂNICO
 EN 14411:2016 GROUP _GRUPO _GROUPE _GRUPPE Bl



20X120 / 8"X48"

▼
10.5 MM
▲



22.5X90 / 9"X36"

▼
9 MM
▲

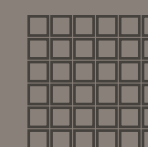

MOSAICO 4,7X4,7
30X30

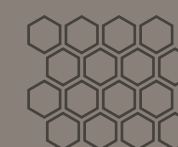

MOSAICO HEXAGONAL
26X31,5



CHEVRON 1
20X120

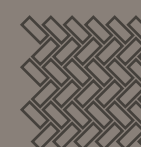

CHEVRON 2
29,9X29,9

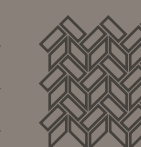

CHEVRON 3
30X30

USAGE _USO

WALL, FLOOR, INTERIOR, EXTERIOR, COMMERCIAL, RESIDENTIAL



VERMONT ASH



VERMONT GREY



VERMONT CREAM



VERMONT TAUPE



VERMONT KHAKI



VERMONT BROWN





VERMONT GREY 20X120 R



VERMONT

GLAZED PORCELAIN TILES _GRÉS PORCELÁNICO VIDRADO _GRÈS CÉRAME ÉMAILLÉ
FEINSTEINZEUG GLASIERT _GRÉS PORCELÁNICO
EN 14411:2016 GROUP _GRUPO _GROUPE _GRUPPE Bla



VERMONT ASH
GP 0645



VERMONT GREY
GP 0646



VERMONT CREAM
GP 0648



VERMONT TAUPE
GP 0649



VERMONT KHAKI
GP 0647



VERMONT BROWN
GP 0650

SURFACE _SUPERFÍCIE

MATT

FEATURES _ATRIBUTOS

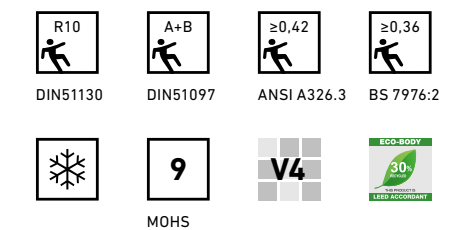

FINISH _ACABAMENTO

NATURAL (NAT)
RECTIFIED (R)

SIZES _FORMATOS

20X120 R
22,5X90 R
22,5X90 NAT

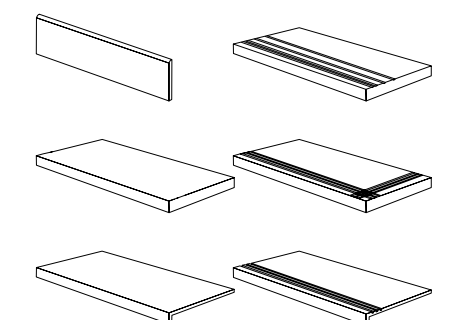

SKIRTINGS _RODAPÉ 9,5X120

SKIRTINGS _RODAPÉ 7X90

STEP _DEGRAU 20X120

STEP _DEGRAU 22,5X90

STEP _DEGRAU TEC. 20X120

STEP _DEGRAU TEC. 22,5X90



OAK

 GLAZED PORCELAIN TILES _GRÉS PORCELÂNICO VIDRADO _GRÈS CÉRAMÉ ÉMAILLÉ
 FEINSTEINZEUG GLASIERT _GRÉS PORCELÂNICO
 EN 14411:2016 GROUP _GRUPO _GROUPE _GRUPPE Bla

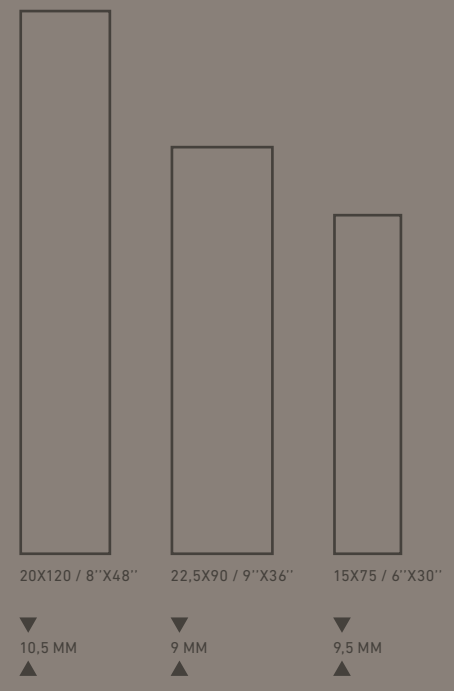

USAGE_USO

WALL, FLOOR, INTERIOR, EXTERIOR, COMMERCIAL, RESIDENTIAL



OAK CREAM 20X120 R
METALLICA TITAN 60X120 SP



OAK HONEY 22,5X90

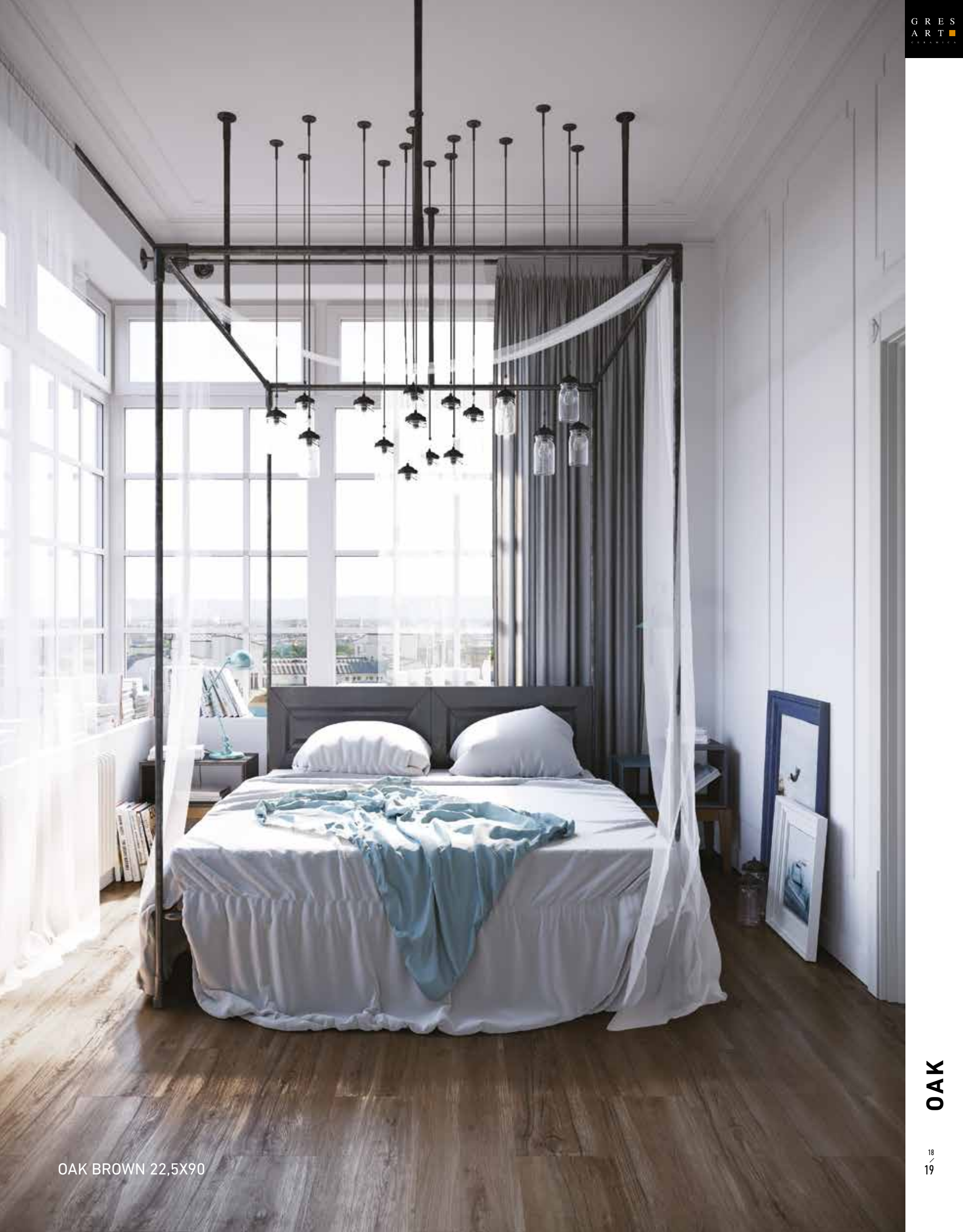

OAK BROWN 22,5X90



OAK TORTORA 20X120 R
BRICK PARDO 33X47



OAK CREAM 20X120 R
METALLICA TITAN 60X120 SP

OAK

 **GLAZED PORCELAIN TILES** _GRÉS PORCELÂNICO VIDRADO _GRÈS CÉRAME ÉMAILLÉ
 FEINSTEINZEUG GLASIERT _GRÉS PORCELÂNICO
 EN 14411:2016 GROUP _GRUPO _GROUPE _GRUPPE Bl



OAK WHITE
GP 0622



OAK TORTORA
GP 0518



OAK TAUPE
GP 0644



OAK DARK
GP 0623

OAK

 **GLAZED PORCELAIN TILES** _GRÉS PORCELÂNICO VIDRADO _GRÈS CÉRAME ÉMAILLÉ
 FEINSTEINZEUG GLASIERT _GRÉS PORCELÂNICO
 EN 14411:2016 GROUP _GRUPO _GROUPE _GRUPPE Bl



OAK BROWN
GP 0515



OAK HONEY
GP 0514



OAK CREAM
GP 0517









OAK TEA
GP 0524

SURFACE _SUPERFÍCIE

MATT

FEATURES _ATRIBUTOS

 R10 DIN51130	 A+B DIN51097	 ≤0.42 ANSI A326.3	 ≥0.36 BS 7976:2
 MOHS 9	 V2	 ECO-BODY 30% RECYCLED CONTENT	

FINISH _ACABAMENTO

NATURAL (NAT)
RECTIFIED (R)

SIZES _FORMATOS

20X120 R
22,5X90 R
22,5X90 NAT
15X75 R
15X75 NAT

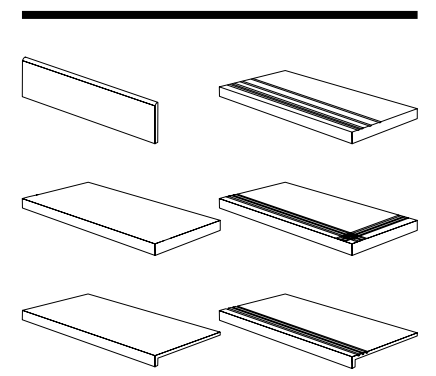

SKIRTINGS _RODAPÉ 9,5X120
 SKIRTINGS _RODAPÉ 7X90
 SKIRTINGS _RODAPÉ 7X75
 STEP _DEGRAU 20X120
 STEP _DEGRAU 22,5X90
 STEP _DEGRAU TEC. 20X120
 STEP _DEGRAU TEC. 22,5X90

SHABBY

 GLAZED PORCELAIN TILES _GRÉS PORCELÂNICO VIDRADO _GRÈS CÉRAMÉ ÉMAILLÉ
 FEINSTEINZEUG GLASIERT _GRÉS PORCELÂNICO
 EN 14411:2016 GROUP _GRUPO _GROUPE _GRUPPE Bla



SHABBY WHITE 20X120 R

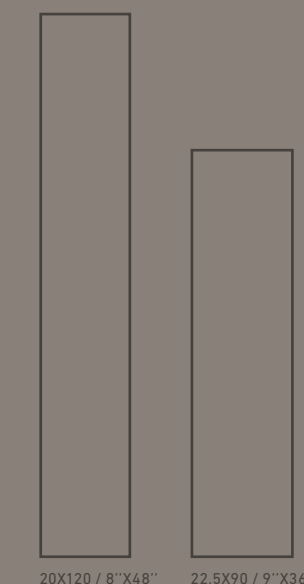

20X120 / 8''X48'' 22.5X90 / 9''X36''

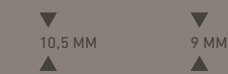

10.5 MM 9 MM

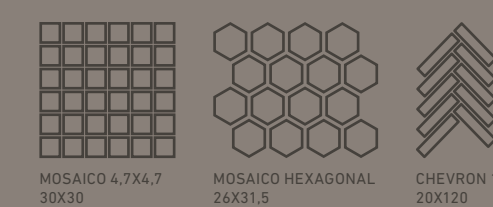

MOSAICO 4,7X4,7 30X30 MOSAICO HEXAGONAL 26X31,5 CHEVRON 1 20X120

USAGE _USO
 WALL, FLOOR, INTERIOR, EXTERIOR, COMMERCIAL, RESIDENTIAL



SHABBY WHITE SHABBY GREY

SHABBY

 **GLAZED PORCELAIN TILES** _GRÉS PORCELÂNICO VIDRADO _GRÈS CÉRAME ÉMAILLÉ
 **FEINSTEINZEUG GLASIERT** _GRÉS PORCELÂNICO
 EN 14411:2016 **GROUP** _GRUPO _GROUPE _GRUPPE **Bl**



SHABBY WHITE
GP 0520



SHABBY GREY
GP 0521

SURFACE _SUPERFÍCIE

MATT

FEATURES _ATRIBUTOS

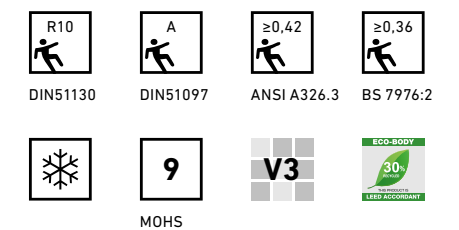

FINISH _ACABAMENTO

NATURAL (NAT)
RECTIFIED (R)

SIZES _FORMATOS

20X120 R
22,5X90 R
22,5X90 NAT

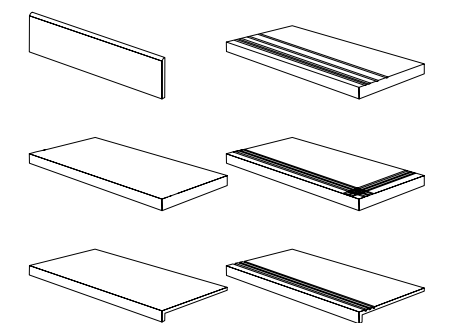

SKIRTINGS _RODAPÉ 9,5X120

SKIRTINGS _RODAPÉ 7X90



STEP _DEGRAU 20X120

STEP _DEGRAU 22,5X90

STEP _DEGRAU TEC. 20X120

STEP _DEGRAU TEC. 22,5X90

PAINTWOOD

 **GLAZED PORCELAIN TILES** _GRÉS PORCELÂNICO VIDRADO _GRÈS CÉRAMÉ ÉMAILLÉ
 **FEINSTEINZEUG GLASIERT** _GRÉS PORCELÂNICO
 EN 14411:2016 GROUP _GRUPO _GROUPE _GRUPPE Bla



20X120 / 8"X48"

▼
10.5 MM
▲



15X75 / 6"X30"

▼
9 MM
▲

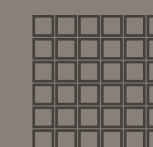

MOSAICO 4,7X4,7
30X30



MOSAICO HEXAGONAL
26X31,5



CHEVRON 1
20X120

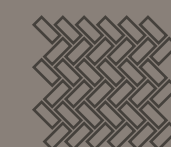

CHEVRON 2
29,9X29,9



CHEVRON 3
30X30

USAGE_USO

WALL, FLOOR, INTERIOR, EXTERIOR, COMMERCIAL, RESIDENTIAL



PAINTWOOD NATURAL



PAINTWOOD WHITE



PAINTWOOD GREY



PAINTWOOD SMOKE







PAINTWOOD GREY 20X120 R

PAINTWOOD

GLAZED PORCELAIN TILES _GRÉS PORCELÂNICO VIDRADO _GRÈS CÉRAME ÉMAILLÉ
FEINSTEINZEUG GLASIERT _GRÉS PORCELÂNICO
EN 14411:2016 GROUP _GRUPO _GROUPE _GRUPPE Bla



PAINTWOOD NATURAL 20X120 R



PAINTWOOD NATURAL
GP 0548

PAINTWOOD NATURAL ANTI-SLIP
GP 0552



PAINTWOOD WHITE
GP 0549

PAINTWOOD WHITE ANTI-SLIP
GP 0553



PAINTWOOD GREY
GP 0550

PAINTWOOD GREY ANTI-SLIP
GP 0554



PAINTWOOD SMOKE
GP 0551

PAINTWOOD SMOKE ANTI-SLIP
GP 0555

SURFACE _SUPERFÍCIE

MATT

FEATURES _ATRIBUTOS

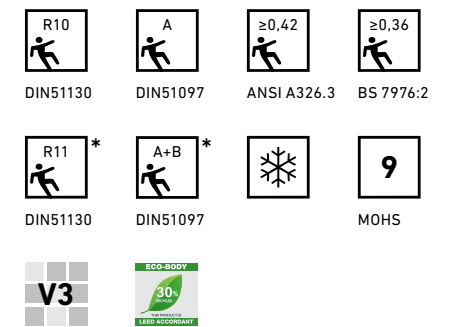

FINISH _ACABAMENTO

NATURAL (NAT)
RECTIFIED (R)

SIZES _FORMATOS

20X120 R
20X120 R ANTI-SLIP*
15X75 R
15X75 R ANTI-SLIP*
15X75 NAT
15X75 NAT ANTI-SLIP*

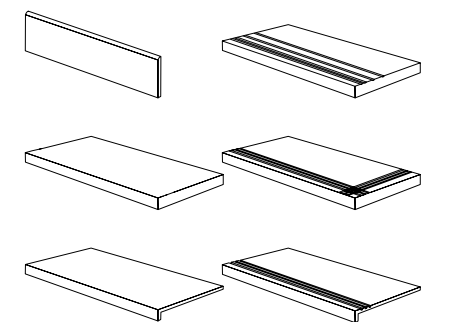

SKIRTINGS _RODAPÉ 9,5X120
SKIRTINGS _RODAPÉ 7X75
STEP _DEGRAU 20X120
STEP _DEGRAU TEC. 20X120

MAPLE

 **GLAZED PORCELAIN TILES** _GRÉS PORCELÂNICO VIDRADO _GRÈS CÉRAME ÉMAILLÉ
 **FEINSTEINZEUG GLASIERT** _GRÉS PORCELÂNICO
 EN 14411:2016 **GROUP** _GRUPO _GROUPE _GRUPPE **Bl**



MAPLE DARK 15X75 R



MAPLE GREY
GP 0495



MAPLE NATURAL
GP 0496



MAPLE DARK
GP 0497

SURFACE _SUPERFÍCIE

MATT

FEATURES _ATRIBUTOS

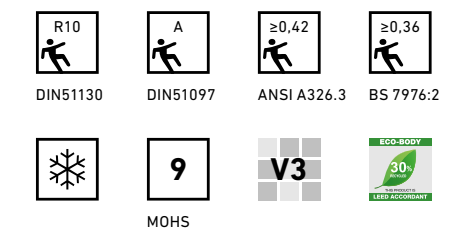

FINISH _ACABAMENTO

NATURAL (NAT)
RECTIFIED (R)

SIZES _FORMATOS

15X75 R
15X75 NAT

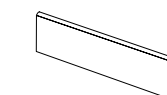

SKIRTINGS _RODAPÉ 7X75



VINTAGE

 GLAZED PORCELAIN TILES _GRÉS PORCELÂNICO VIDRADO _GRÈS CÉRAMÉ ÉMAILLÉ
 FEINSTEINZEUG GLASIERT _GRÉS PORCELÂNICO
 EN 14411:2016 GROUP _GRUPO _GROUPE _GRUPPE Bla



15X60 / 6"X24"

▼
8,7 MM
▲

USAGE_USO

WALL, FLOOR, INTERIOR, EXTERIOR, COMMERCIAL, RESIDENTIAL



VINTAGE BEGE



VINTAGE CINZA



VINTAGE MEL



VINTAGE CASTANHO



VINTAGE ANTRACITE



LINIA VINTAGE 33X47

VINTAGE

 **GLAZED PORCELAIN TILES** _GRÉS PORCELÂNICO VIDRADO _GRÈS CÉRAME ÉMAILLÉ
 FEINSTEINZEUG GLASIERT _GRÉS PORCELÂNICO
 EN 14411:2016 GROUP _GRUPO _GROUPE _GRUPPE Bla



VINTAGE BEGE DECOR
GPC 0373



VINTAGE CINZA DECOR
GPC 0372



VINTAGE MEL DECOR
GPC 0374



VINTAGE CASTANHO DECOR
GPC 0375



VINTAGE ANTRACITE DECOR
GPC 0429

VINTAGE

 **GLAZED PORCELAIN TILES** _GRÉS PORCELÂNICO VIDRADO _GRÈS CÉRAME ÉMAILLÉ
 FEINSTEINZEUG GLASIERT _GRÉS PORCELÂNICO
 EN 14411:2016 GROUP _GRUPO _GROUPE _GRUPPE Bla



VINTAGE BEGE
GPC 0369



VINTAGE CINZA
GPC 0368



VINTAGE MEL
GPC 0370



VINTAGE CASTANHO
GPC 0371



VINTAGE ANTRACITE
GPC 0420

SURFACE _SUPERFÍCIE

MATT

FEATURES _ATRIBUTOS

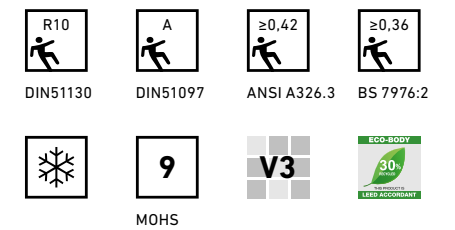

FINISH _ACABAMENTO

NATURAL (NAT)

SIZES _FORMATOS

15X60 CUT

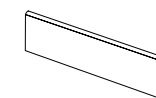

SKIRTINGS _RODAPÉ 7X60



DECK

 GLAZED PORCELAIN TILES _GRÉS PORCELÂNICO VIDRADO _GRÈS CÉRAMÉ ÉMAILLÉ
 FEINSTEINZEUG GLASIERT _GRÉS PORCELÂNICO
 EN 14411:2016 GROUP _GRUPO _GROUPE _GRUPPE Bla

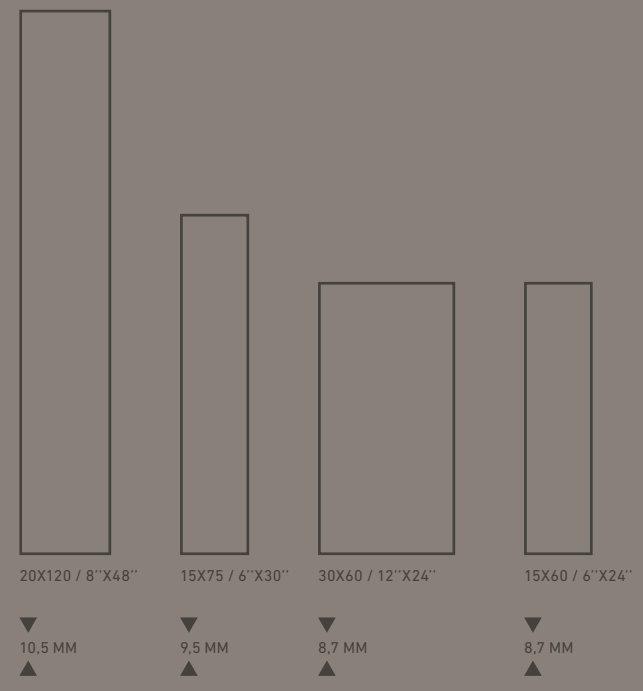

USAGE _USO

WALL, FLOOR, INTERIOR, EXTERIOR, COMMERCIAL, RESIDENTIAL

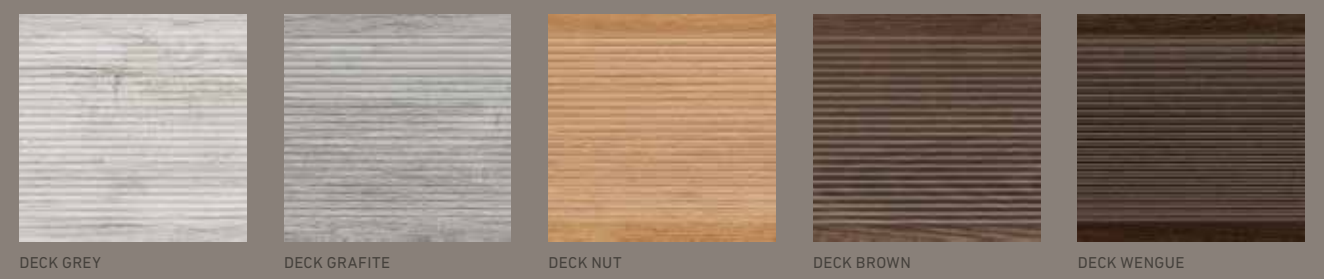

DECK WENGUE 15X60



DECK

 **GLAZED PORCELAIN TILES** _GRÉS PORCELÂNICO VIDRADO _GRÈS CÉRAMÉ ÉMAILLÉ
 **FEINSTEINZEUG GLASIERT** _GRÉS PORCELÂNICO
 EN 14411:2016 **GROUP** _GRUPO _GROUPE _GRUPPE **Bl**



DECK GREY
GP 0417



DECK GRAFITE
GP 0418



DECK NUT
GP 0415

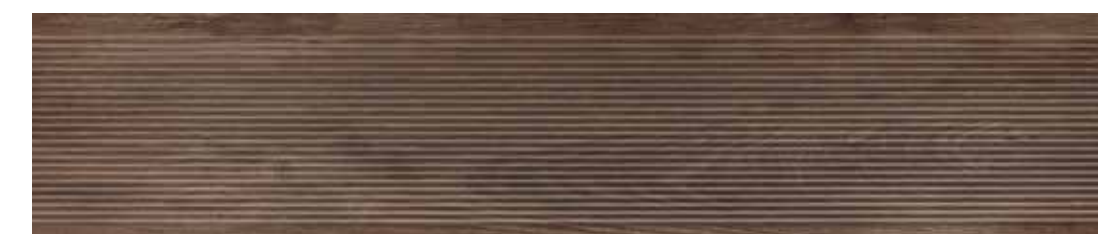

DECK BROWN
GP 0443



DECK WENGUE
GP 0419

SURFACE _SUPERFÍCIE

MATT ANTI-SLIP

FEATURES _ATRIBUTOS

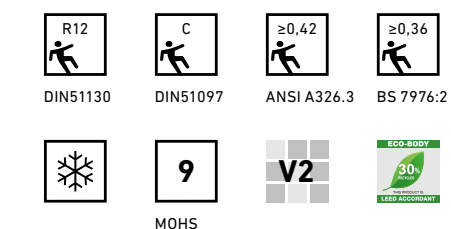

FINISH _ACABAMENTO

NATURAL (NAT)
RECTIFIED (R)

SIZES _FORMATOS

20X120 R
15X75 R
15X75 NAT
30X60 NAT
15X60 CUT

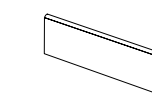

SKIRTINGS _RODAPÉ 9,5X120
SKIRTINGS _RODAPÉ 7X75
SKIRTINGS _RODAPÉ 7X60



ANARCHIC CREAM 90X90 R

ANARCHIC

 **GLAZED PORCELAIN TILES** _GRÉS PORCELÂNICO VIDRADO _GRÈS CÉRAMÉ ÉMAILLÉ
 **FEINSTEINZEUG GLASIERT** _GRÉS PORCELÂNICO
 EN 14411:2016 GROUP _GRUPO _GROUPE _GRUPPE **Bl**a

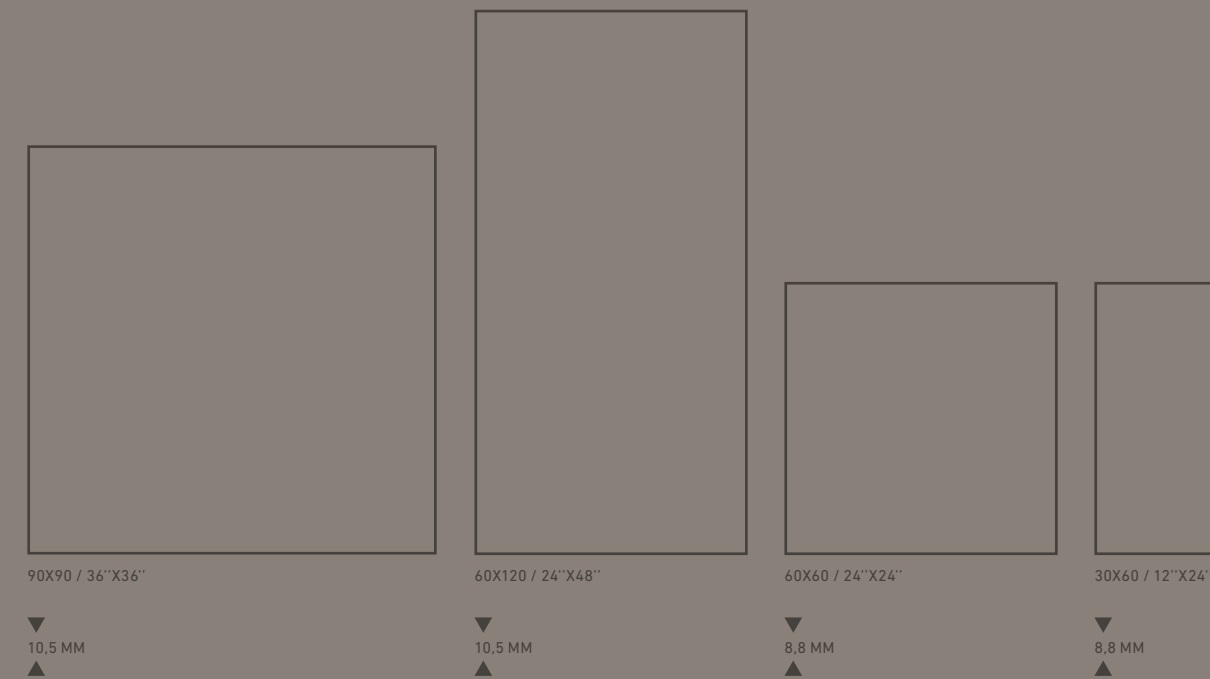

USAGE _USO

WALL, FLOOR, INTERIOR, EXTERIOR, COMMERCIAL, RESIDENTIAL

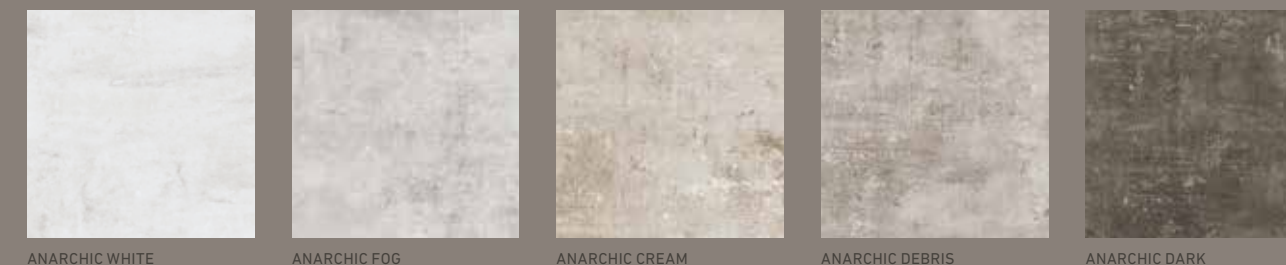



ANARCHIC FOG 90X90 R



ANARCHIC DARK 90X90 R

ANARCHIC

 **GLAZED PORCELAIN TILES** _GRÉS PORCELÂNICO VIDRADO _GRÈS CÉRAME ÉMAILLÉ
 FEINSTEINZEUG GLASIERT _GRÉS PORCELÂNICO
 EN 14411:2016 GROUP _GRUPO _GROUPE _GRUPPE **BIa**



ANARCHIC WHITE DECOR
GP 0702



ANARCHIC FOG DECOR
GP 0704



ANARCHIC CREAM DECOR
GP 0705



ANARCHIC DEBRIS DECOR
GP 0703



ANARCHIC DARK DECOR
GP 0706

ANARCHIC

 **GLAZED PORCELAIN TILES** _GRÉS PORCELÂNICO VIDRADO _GRÈS CÉRAME ÉMAILLÉ
 FEINSTEINZEUG GLASIERT _GRÉS PORCELÂNICO
 EN 14411:2016 GROUP _GRUPO _GROUPE _GRUPPE **BIa**



ANARCHIC WHITE
GP 0697



ANARCHIC FOG
GP 0699



ANARCHIC CREAM
GP 0700



ANARCHIC DEBRIS
GP 0698



ANARCHIC DARK
GP 0701

SURFACE _SUPERFÍCIE

MATT

FEATURES _ATRIBUTOS

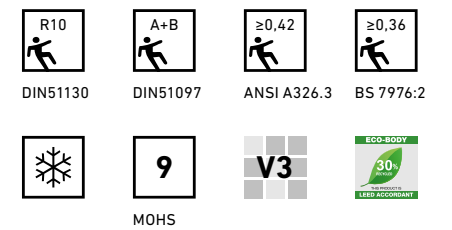

FINISH _ACABAMENTO

NATURAL (NAT)
RECTIFIED (R)

SIZES _FORMATOS

90X90 R
45X90 R
60X120 R
60X60 R
60X60 NAT
30X60 R

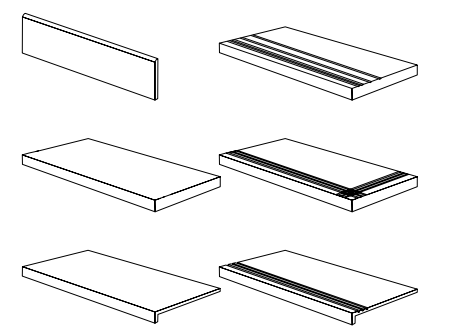

SKIRTINGS _RODAPÉ 9X90
 SKIRTINGS _RODAPÉ 9X120
 SKIRTINGS _RODAPÉ 9X60
 STEP _DEGRAU 45X90
 STEP _DEGRAU 60X120
 STEP _DEGRAU 60X60
 STEP _DEGRAU TEC. 30X90
 STEP _DEGRAU TEC. 30X120
 STEP _DEGRAU TEC. 30X60

SASSI

GLAZED PORCELAIN TILES _GRÉS PORCELÂNICO VIDRADO _GRÈS CÉRAME ÉMAILLÉ
FEINSTEINZEUG GLASIERT _GRÉS PORCELÁNICO
EN 14411:2016 GROUP _GRUPO _GROUPE _GRUPPE Bla



SASSI FOG 60X60 R
SASSI FOG 30X60 R

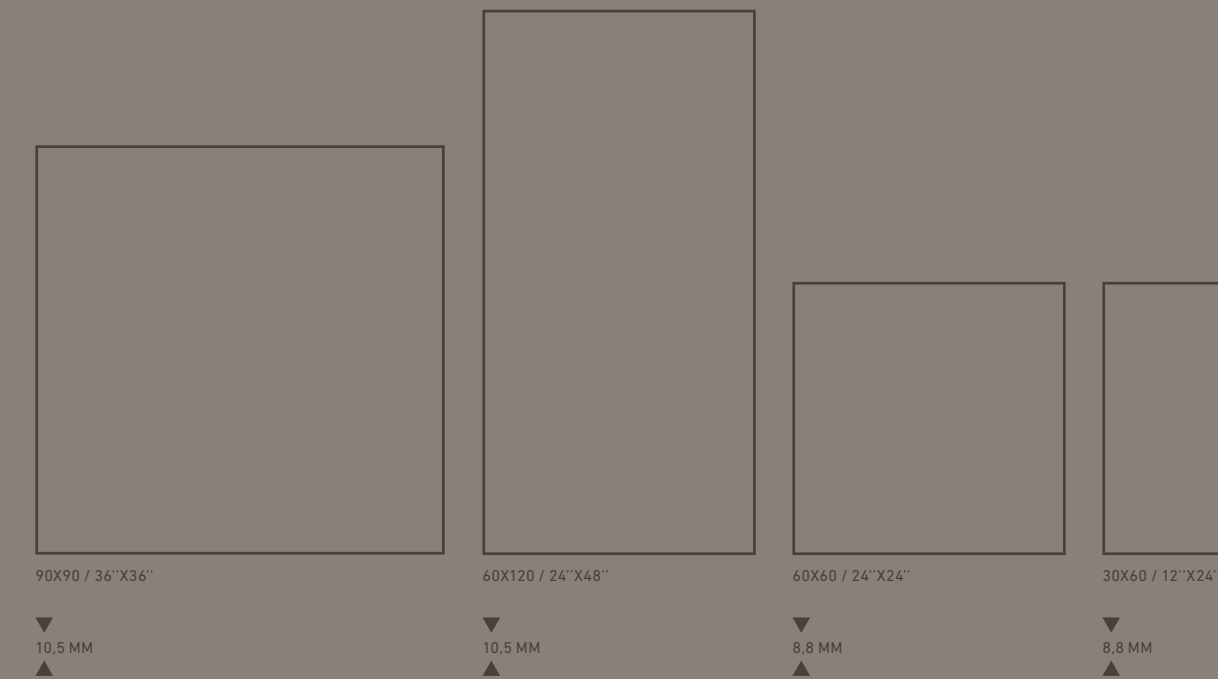

USAGE _USO

WALL, FLOOR, INTERIOR, EXTERIOR, COMMERCIAL, RESIDENTIAL



SASSI WHITE



SASSI FOG



SASSI TAUPE



SASSI SMOKE

SASSI

GLAZED PORCELAIN TILES _GRÉS PORCELÂNICO VIDRADO _GRÈS CÉRAME ÉMAILLÉ
FEINSTEINZEUG GLASIERT _GRÉS PORCELÂNICO
EN 14411:2016 GROUP _GRUPO _GROUPE _GRUPPE Bla



SASSI TAUPE 30X60 R



SASSI WHITE
GP 0655



SASSI FOG
GP 0656



SASSI TAUPE
GP 0657



SASSI SMOKE
GP 0658

SURFACE _SUPERFÍCIE

MATT

FEATURES _ATRIBUTOS

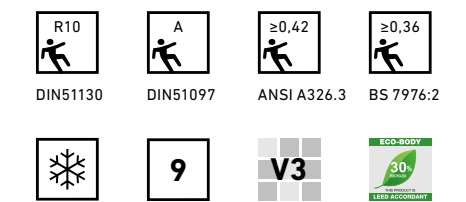

FINISH _ACABAMENTO

NATURAL (NAT)
RECTIFIED (R)

SIZES _FORMATOS

90X90 R
45X90 R
60X120 R
60X60 R
60X60 NAT
30X60 R

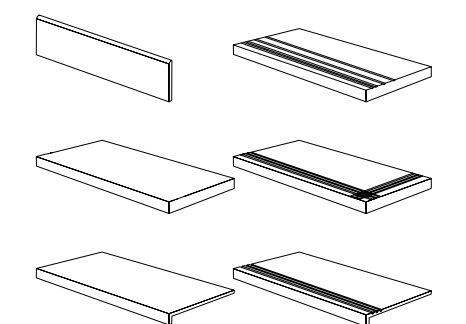

SKIRTINGS _RODAPÉ 9X90
SKIRTINGS _RODAPÉ 9X120
SKIRTINGS _RODAPÉ 9X60
STEP _DEGRAU 45X90
STEP _DEGRAU 60X120
STEP _DEGRAU 60X60
STEP _DEGRAU TEC. 30X90
STEP _DEGRAU TEC. 30X120
STEP _DEGRAU TEC. 30X60



URBAN CONCRETE

 GLAZED PORCELAIN TILES _GRÉS PORCELÂNICO VIDRADO _GRÈS CÉRAMÉ ÉMAILLÉ
 FEINSTEINZEUG GLASIERT _GRÉS PORCELÁNICO
 EN 14411:2016 GROUP _GRUPO _GROUPE _GRUPPE Bla



60X60 / 24"X24"

▼
8,8 MM
▲



30X60 / 12"X24"

▼
8,8 MM
▲

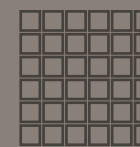

MOSAICO 4,7X4,7
30X30



MOSAICO LOSANGO
23,6X28

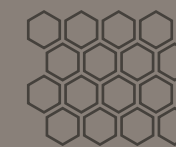

MOSAICO HEXAGONAL
26X31,5

USAGE _USO

WALL, FLOOR, INTERIOR, EXTERIOR, COMMERCIAL, RESIDENTIAL



URBAN CONCRETE SAND



URBAN CONCRETE CREAM



URBAN CONCRETE FOG



URBAN CONCRETE SMOKE

URBAN CONCRETE

 **GLAZED PORCELAIN TILES** _GRÉS PORCELÂNICO VIDRADO _GRÈS CÉRAME ÉMAILLÉ
 **FEINSTEINZEUG GLASIERT** _GRÉS PORCELÂNICO
 EN 14411:2016 GROUP _GRUPO _GROUPE _GRUPPE Bla



URBAN CONCRETE FOG 60X60 R



URBAN CONCRETE SAND
GP 0665



URBAN CONCRETE CREAM
GP 0666



URBAN CONCRETE FOG
GP 0667



URBAN CONCRETE SMOKE
GP 0668



URBAN CONCRETE DECOR FOG
GP 0669



URBAN CONCRETE DECOR CREAM
GP 0670

SURFACE _SUPERFÍCIE

MATT

FEATURES _ATRIBUTOS

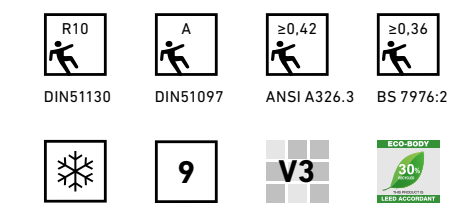

FINISH _ACABAMENTO

NATURAL (NAT)
RECTIFIED (R)

SIZES _FORMATOS

60X60 R
60X60 NAT
30X60 R

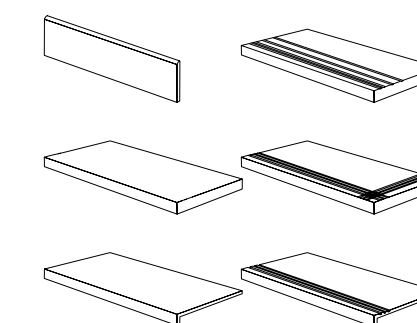

SKIRTINGS _RODAPE 9X60
STEP _DEGRAU 60X60
STEP _DEGRAU TEC. 30X60

CEMENTONE

GLAZED PORCELAIN TILES _GRÉS PORCELÂNICO VIDRADO _GRÈS CÉRAMÉ ÉMAILLÉ
FEINSTEINZEUG GLASIERT _GRÉS PORCELÂNICO
EN 14411:2016 GROUP _GRUPO _GROUPE _GRUPPE **Bl**



CEMENTONE CAMOU 60X60



60X60 / 24\"X24\"

30X60 / 12\"X24\"

▼
8,8 MM
▲

▼
8,8 MM
▲

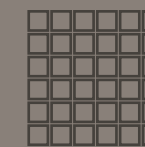

MOSAICO 4,7X4,7
30X30



MOSAICO LOSANGO
23,6X28

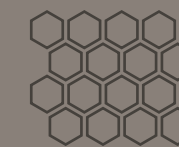

MOSAICO HEXAGONAL
26X31,5

USAGE _USO

WALL, FLOOR, INTERIOR, EXTERIOR, COMMERCIAL, RESIDENTIAL



CEMENTONE SAND



CEMENTONE GREY



CEMENTONE SMOKE



CEMENTONE DARK

CEMENTONE

 **GLAZED PORCELAIN TILES** _GRÉS PORCELÂNICO VIDRADO _GRÈS CÉRAME ÉMAILLÉ
 **FEINSTEINZEUG GLASIERT** _GRÉS PORCELÂNICO
 EN 14411:2016 GROUP _GRUPO _GROUPE _GRUPPE Bla



CEMENTONE GREY 60X60 R



CEMENTONE SAND
GP 0659



CEMENTONE GREY
GP 0660



CEMENTONE SMOKE
GP 0661



CEMENTONE DARK
GP 0662



CEMENTONE CAMOU
GP 0663

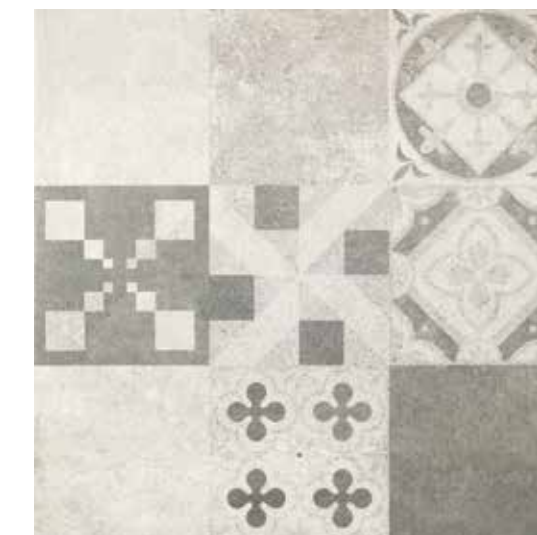

CEMENTONE HIDRÁULICO
GP 0664

SURFACE _SUPERFÍCIE

MATT

FEATURES _ATRIBUTOS

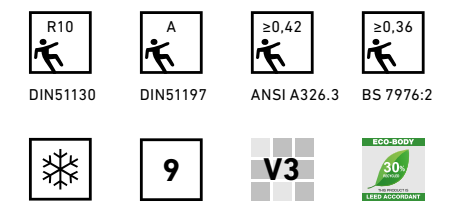

FINISH _ACABAMENTO

NATURAL (NAT)
RECTIFIED (R)

SIZES _FORMATOS

60X60 R
60X60 NAT
30X60 R

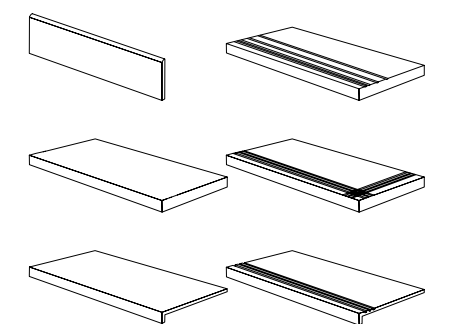

SKIRTINGS _RODAPE 9X60
 STEP _DEGRAU 60X60
 STEP _DEGRAU TEC. 30X60



LIVING FOG 60X60

LIVING

GLAZED PORCELAIN TILES _GRÉS PORCELÂNICO VIDRADO _GRÈS CÉRAMÉ ÉMAILLÉ
 FEINSTEINZEUG GLASIERT _GRÉS PORCELÁNICO
 EN 14411:2016 GROUP _GRUPO _GROUPE _GRUPPE **Bl**

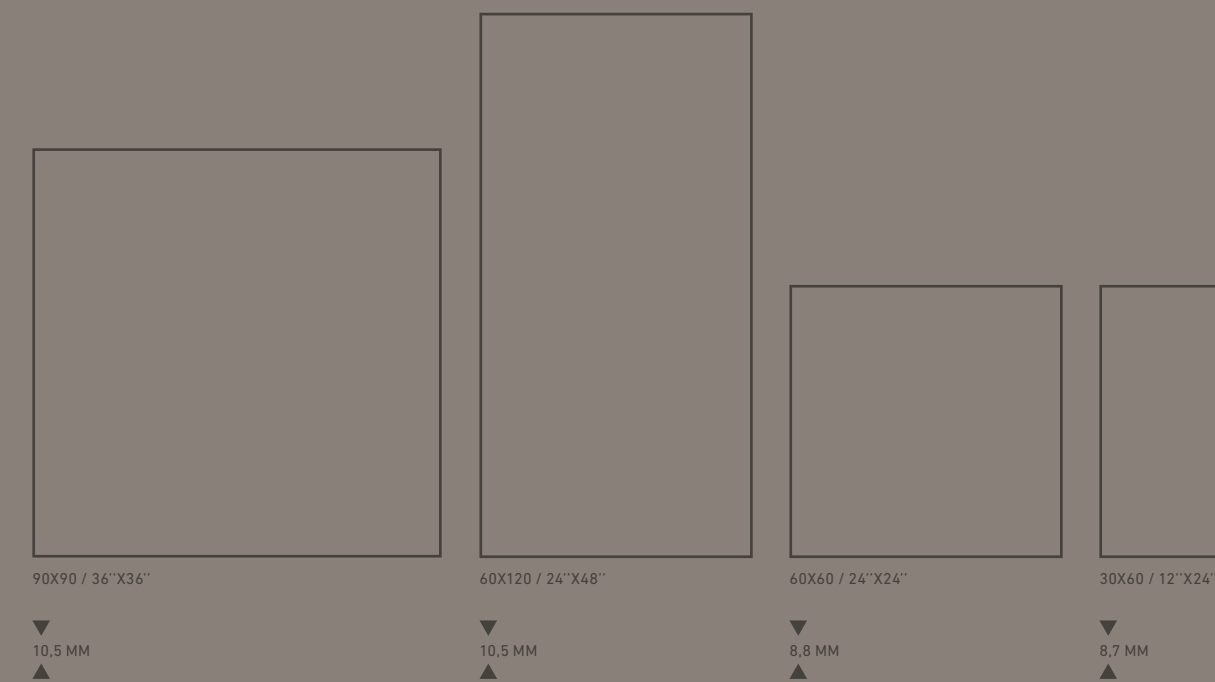

USAGE _USO

WALL, FLOOR, INTERIOR, EXTERIOR, COMMERCIAL, RESIDENTIAL



LIVING CREAM LIVING TORTORA LIVING FOG LIVING SMOKE

LIVING

GLAZED PORCELAIN TILES _GRÉS PORCELÁNICO VIDRADO _GRÈS CÉRAMÉ ÉMAILLÉ
FEINSTEINZEUG GLASIERT _GRÉS PORCELÁNICO
EN 14411:2016 GROUP _GRUPO _GROUPE _GRUPPE B1a



LIVING SMOKE 60X60



LIVING CREAM
GP 0541



LIVING TORTORA
GP 0542



LIVING FOG
GP 0543



LIVING SMOKE
GP 0544

SURFACE _SUPERFÍCIE

MATT

FEATURES _ATRIBUTOS

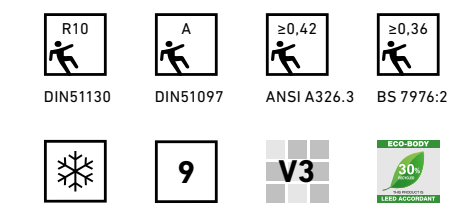

FINISH _ACABAMENTO

NATURAL (NAT)
RECTIFIED (R)

SIZES _FORMATOS

90X90 R
45X90 R
60X120 R
60X60 R
60X60 NAT
30X60 R
30X60 NAT

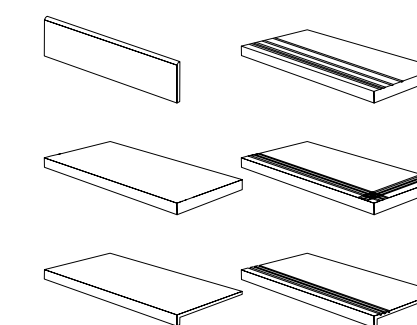

SKIRTINGS _RODAPÉ 9X90
SKIRTINGS _RODAPÉ 9X120
SKIRTINGS _RODAPÉ 9X60
STEP _DEGRAU 45X90
STEP _DEGRAU 60X120
STEP _DEGRAU 60X60
STEP _DEGRAU TEC. 30X90
STEP _DEGRAU TEC. 30X120
STEP _DEGRAU TEC. 30X60

LIVING LINES&SQUARES

 **GLAZED PORCELAIN TILES** _GRÉS PORCELÂNICO VIDRADO _GRÈS CÉRAMÉ ÉMAILLÉ
FEINSTEINZEUG GLASIERT _GRÉS PORCELÁNICO
EN 14411:2016 GROUP _GRUPO _GROUPE _GRUPPE Bla



LINES LIGHT
GP 0606



LINES DARK
GP 0607



SQUARES LIGHT
GP 0608



SQUARES DARK
GP 0609

SURFACE _SUPERFÍCIE

MATT

FEATURES _ATRIBUTOS



FINISH _ACABAMENTO

NATURAL (NAT)

SIZES _FORMATOS

30X60 NAT



SQUARES DARK 30X60
LIVING FOG 60X60



LIVING HIDRÁULICO.FOG 60X60

LIVING HIDRÁULICO

GLAZED PORCELAIN TILES _GRÉS PORCELÂNICO VIDRADO _GRÈS CÉRAME ÉMAILLÉ
FEINSTEINZEUG GLASIERT _GRÉS PORCELÁNICO
EN 14411:2016 GROUP _GRUPO _GROUPE _GRUPPE Bla



LIVING HIDRÁULICO FOG
GP 0584

LIVING HIDRÁULICO

GLAZED PORCELAIN TILES _GRÉS PORCELÂNICO VIDRADO _GRÈS CÉRAME ÉMAILLÉ
FEINSTEINZEUG GLASIERT _GRÉS PORCELÁNICO
EN 14411:2016 GROUP _GRUPO _GROUPE _GRUPPE Bla

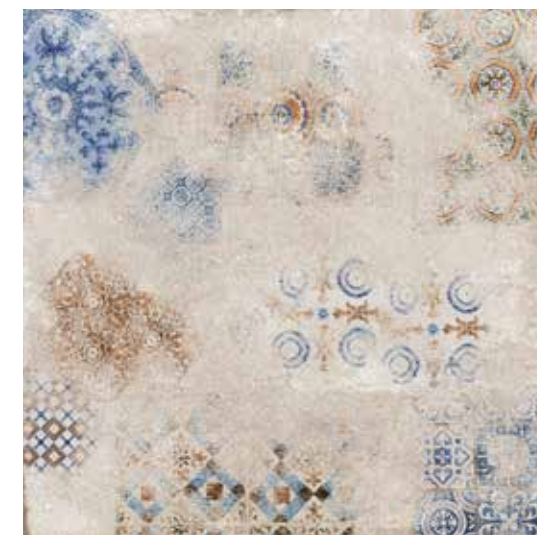
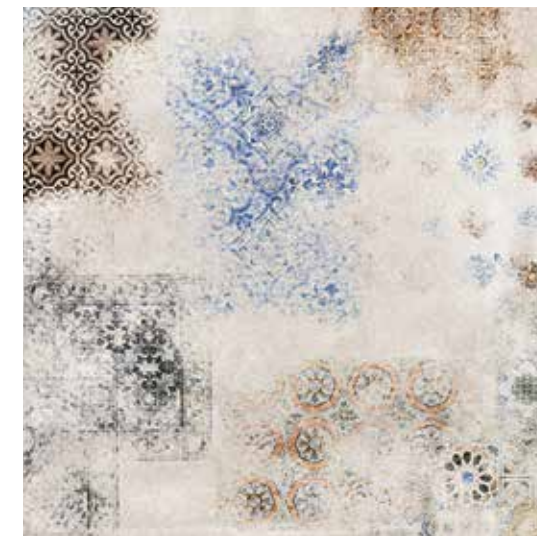

LIVING HIDRÁULICO CREAM
GP 0583

SURFACE _SUPERFÍCIE

MATT

FEATURES _ATRIBUTOS

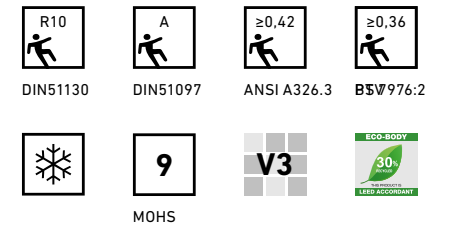



FINISH _ACABAMENTO

NATURAL (NAT)
RECTIFIED (R)

SIZES _FORMATOS

60X60 R
60X60 NAT

RUSTY

 **GLAZED PORCELAIN TILES** _GRÉS PORCELÁNICO VIDRADO _GRÈS CÉRAME ÉMAILLÉ
 **FEINSTEINZEUG GLASIERT** _GRÉS PORCELÁNICO
EN 14411:2016 GROUP _GRUPO _GROUPE _GRUPPE **BIa**



RUSTY FOG 60X60



60X60 / 24"X24"

30X60 / 12"X24"

▼
8,8 MM
▲

▼
8,7 MM
▲

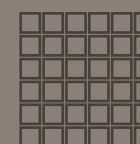

MOSAICO 4,7X4,7
30X30



MOSAICO LOSANGO
23,6X28

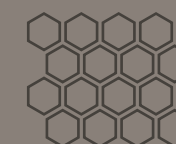

MOSAICO HEXAGONAL
26X31,5

USAGE _USO

WALL, FLOOR, INTERIOR, EXTERIOR, COMMERCIAL, RESIDENTIAL



RUSTY SAND



RUSTY ASH



RUSTY FOG



RUSTY SMOKE



RUSTY BROWN

RUSTY

GLAZED PORCELAIN TILES _GRÉS PORCELÂNICO VIDRADO _GRÈS CÉRAME ÉMAILLÉ
FEINSTEINZEUG GLASIERT _GRÉS PORCELÂNICO
EN 14411:2016 GROUP _GRUPO _GROUPE _GRUPPE Bla



RUSTY SAND
GP 0535



RUSTY ASH
GP 0536



RUSTY FOG
GP 0537



RUSTY SMOKE
GP 0538



RUSTY BROWN
GP 0539



RUSTY DECOR
GP 0540

SURFACE _SUPERFÍCIE

MATT

FEATURES _ATRIBUTOS

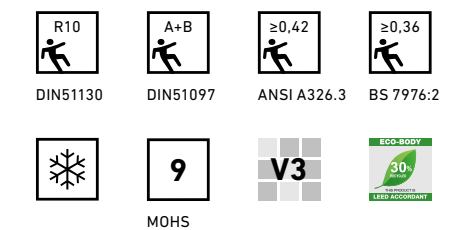

FINISH _ACABAMENTO

NATURAL (NAT)
RECTIFIED (R)

SIZES _FORMATOS

60X60 R
60X60 NAT
30X60 R
30X60 NAT

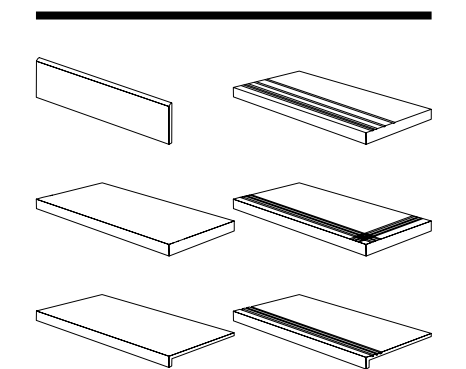

SKIRTINGS _RODAPÉ 9X60
STEP _DEGRAU 60X60
STEP _DEGRAU TEC. 30X60

BETON

GLAZED PORCELAIN TILES _GRÉS PORCELÂNICO VIDRADO _GRÈS CÉRAMÉ ÉMAILLÉ
FEINSTEINZEUG GLASIERT _GRÉS PORCELÂNICO
EN 14411:2016 GROUP _GRUPO _GROUPE _GRUPPE Bla



BETON NUT 60X60

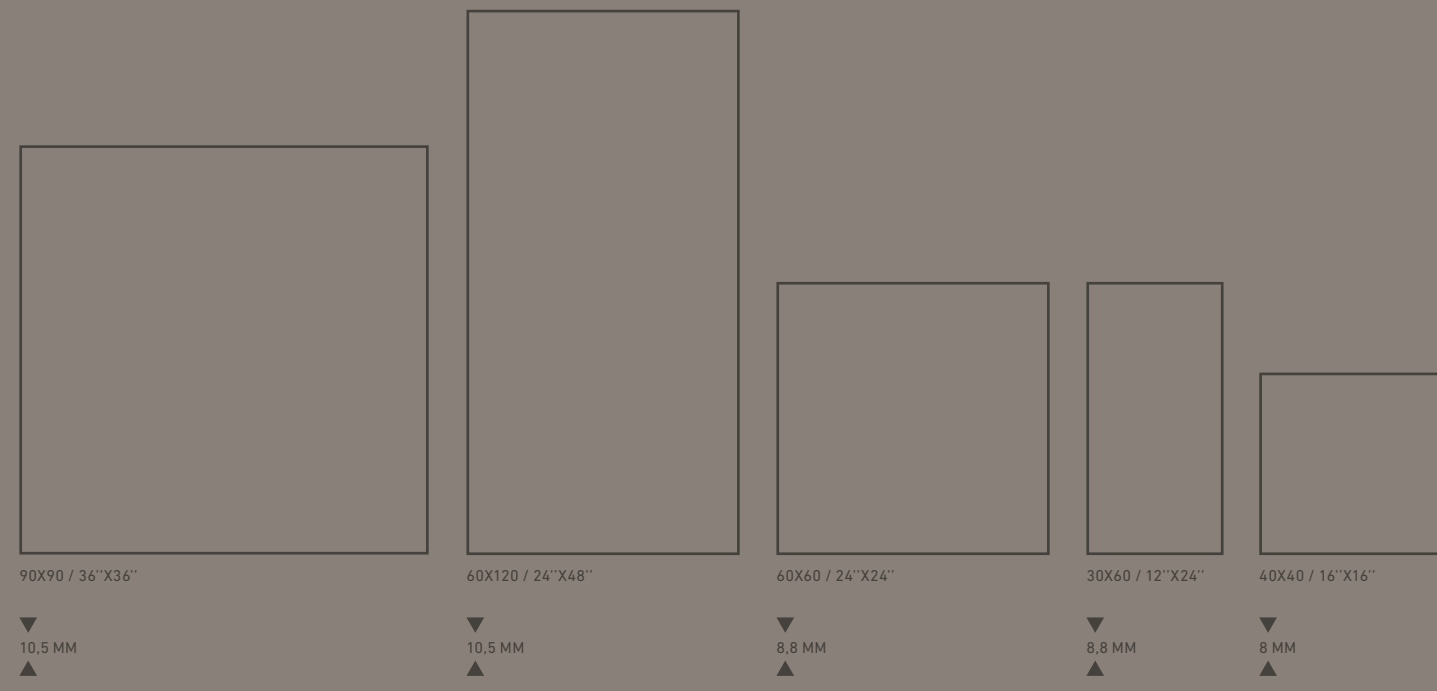

USAGE _USO

WALL, FLOOR, INTERIOR, EXTERIOR, COMMERCIAL, RESIDENTIAL







BETON NUT 60X60
BETON HIDRÁULICO 60X60
BRICK CASTANHO 33X47

BETON

 **GLAZED PORCELAIN TILES** _GRÉS PORCELÂNICO VIDRADO _GRÈS CÉRAME ÉMAILLÉ
 **FEINSTEINZEUG GLASIERT** _GRÉS PORCELÂNICO
 EN 14411:2016 **GROUP** _GRUPO _GROUPE _GRUPPE **Bl**



BETON WHITE
GP 0438



BETON FOG
GP 0439



BETON NUT
GP 0440



BETON SMOKE
GP 0441

SURFACE _SUPERFÍCIE

MATT
SEMI-POLISHED (SP)

FEATURES _ATRIBUTOS

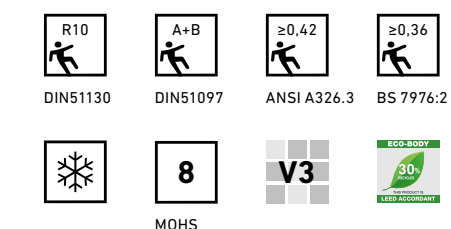

FINISH _ACABAMENTO

NATURAL (NAT)
RECTIFIED (R)

SIZES _FORMATOS

90X90 R
90X90 SP
45X90 R
45X90 SP
60X120 R
60X120 SP
60X60 R
60X60 SP
60X60 NAT
30X60 R
30X60 SP
40X40 NAT

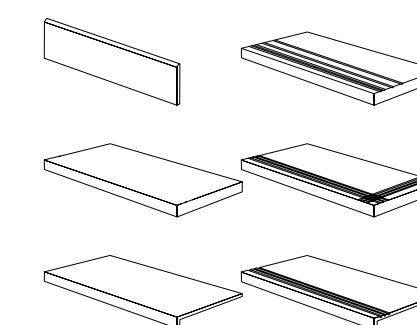

SKIRTINGS _RODAPÉ 9X90
SKIRTINGS _RODAPÉ 9X120
SKIRTINGS _RODAPÉ 9X60
SKIRTINGS _RODAPÉ 8X40
STEP _DEGRAU 45X90
STEP _DEGRAU 60X120
STEP _DEGRAU 60X60
STEP _DEGRAU 40X40
STEP _DEGRAU TEC. 30X90
STEP _DEGRAU TEC. 30X120
STEP _DEGRAU TEC. 30X60

BETON HIDRÁULICO

GLAZED PORCELAIN TILES _GRÉS PORCELÂNICO VIDRADO _GRÈS CÉRAME ÉMAILLÉ
 FEINSTEINZEUG GLASIERT _GRÉS PORCELÁNICO
 EN 14411:2016 GROUP _GRUPO _GROUPE _GRUPPE Bla



BETON FOG 60X60
 BETON HIDRÁULICO 60X60











BETON HIDRÁULICO DECOR
 GP 0468

PEÇAS EMBALADAS ALEATORIAMENTE POR CAIXA
 TILES ARE PACKED RANDOMLY IN THE SAME BOX

SURFACE _SUPERFÍCIE

MATT

FEATURES _ATRIBUTOS

 R10 DIN51130	 A+B DIN51097	 ≤0.42 ANSI A326.3	 ≥0.36 BS 7976:2
 MOHS	 8	 V3	 ECO-BODY 30% LEVEL ACCORDANT

FINISH _ACABAMENTO

NATURAL (NAT)

SIZES _FORMATOS

60X60 NAT

BETON PATCHWORK

GLAZED PORCELAIN TILES _GRÉS PORCELÂNICO VIDRADO _GRÈS CÉRAME ÉMAILLÉ
FEINSTEINZEUG GLASIERT _GRÉS PORCELÁNICO
EN 14411:2016 GROUP _GRUPO _GROUPE _GRUPPE Bla



BETON PATCHWORK 30X60

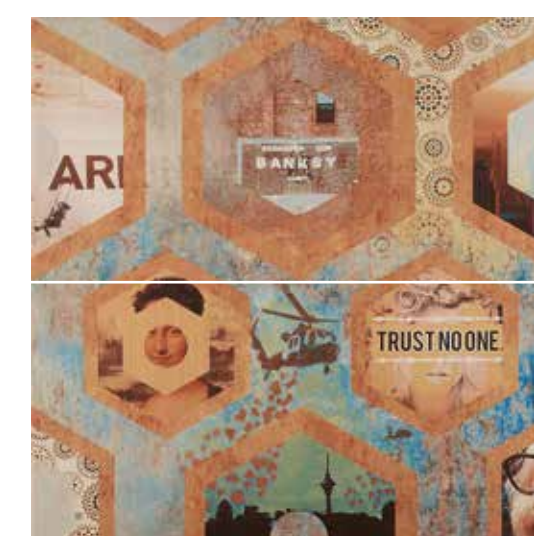
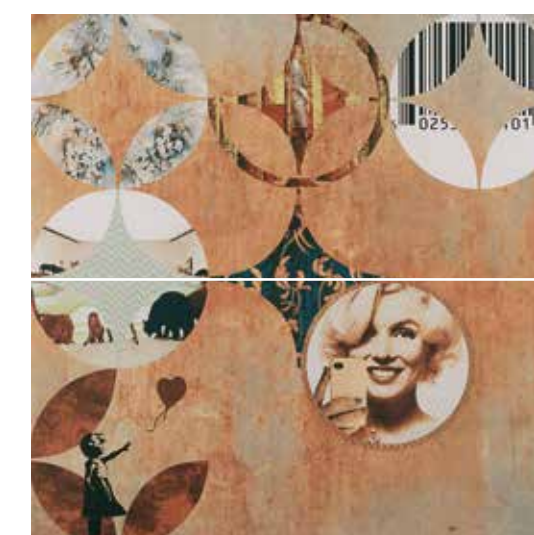
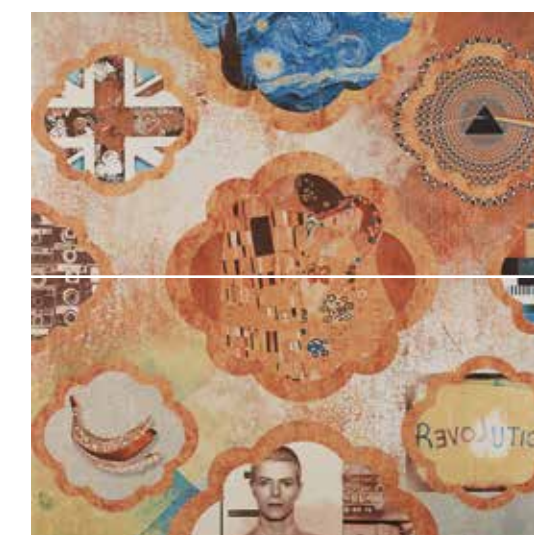

BETON PATCHWORK
GP 0452

PEÇAS EMBALADAS ALEATORIAMENTE POR CAIXA
TILES ARE PACKED RANDOMLY IN THE SAME BOX

SURFACE _SUPERFÍCIE

MATT

FEATURES _ATRIBUTOS

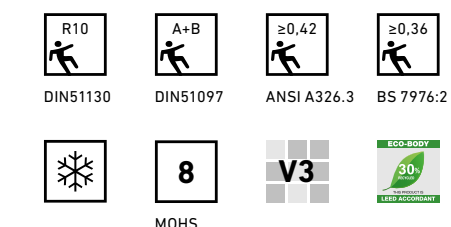

FINISH _ACABAMENTO

NATURAL (NAT)
RECTIFIED (R)

SIZES _FORMATOS

60X60 R
60X60 NAT
30X60 R

HERITAGE

 GLAZED PORCELAIN TILES _GRÉS PORCELÂNICO VIDRADO _GRÈS CÉRAMÉ ÉMAILLÉ
 FEINSTEINZEUG GLASIERT _GRÉS PORCELÁNICO
 EN 14411:2016 GROUP _GRUPO _GROUPE _GRUPPE Bla



40X40 / 16"X16"

▼
8 MM
▲

USAGE _USO

WALL, FLOOR, INTERIOR, EXTERIOR, COMMERCIAL, RESIDENTIAL



HERITAGE GREY



HERITAGE COLOR



HERITAGE MIX GREY



HERITAGE MIX COLOR



HERITAGE GREY 1 40X40



BETON HERITAGE GREY 40X40



BETON HERITAGE MIX 40X40

HERITAGE GREY

GLAZED PORCELAIN TILES _GRÉS PORCELÂNICO VIDRADO _GRÈS CÉRAME ÉMAILLÉ
FEINSTEINZEUG GLASIERT _GRÉS PORCELÂNICO
EN 14411:2016 GROUP _GRUPO _GROUPE _GRUPPE Bla



HERITAGE GREY 1
GP 0679



HERITAGE GREY 2
GP 0680



HERITAGE GREY 3
GP 0681



HERITAGE GREY 4
GP 0682



HERITAGE GREY 5
GP 0683



HERITAGE GREY 6
GP 0684

HERITAGE COLOR

GLAZED PORCELAIN TILES _GRÉS PORCELÂNICO VIDRADO _GRÈS CÉRAME ÉMAILLÉ
FEINSTEINZEUG GLASIERT _GRÉS PORCELÂNICO
EN 14411:2016 GROUP _GRUPO _GROUPE _GRUPPE Bla



HERITAGE COLOR 1
GP 0685



HERITAGE COLOR 2
GP 0686



HERITAGE COLOR 3
GP 0687



HERITAGE COLOR 4
GP 0688



HERITAGE COLOR 5
GP 0689

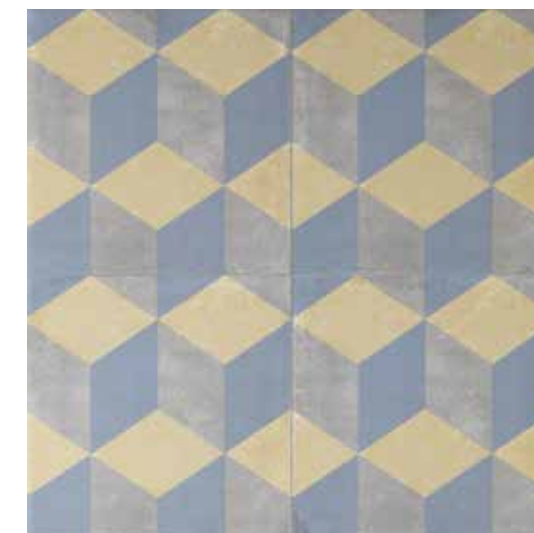

HERITAGE COLOR 6
GP 0690

SURFACE _SUPERFÍCIE

MATT

FEATURES _ATRIBUTOS

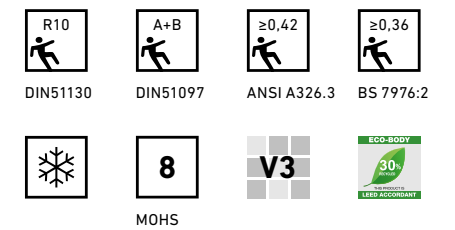

FINISH _ACABAMENTO

NATURAL (NAT)
PRE-CUT

SIZES _FORMATOS

40X40 NAT

HERITAGE MIX GREY

GLAZED PORCELAIN TILES _GRÉS PORCELÂNICO VIDRADO _GRÈS CÉRAME ÉMAILLÉ
FEINSTEINZEUG GLASIERT _GRÉS PORCELÂNICO
EN 14411:2016 GROUP _GRUPO _GROUPE _GRUPPE Bla

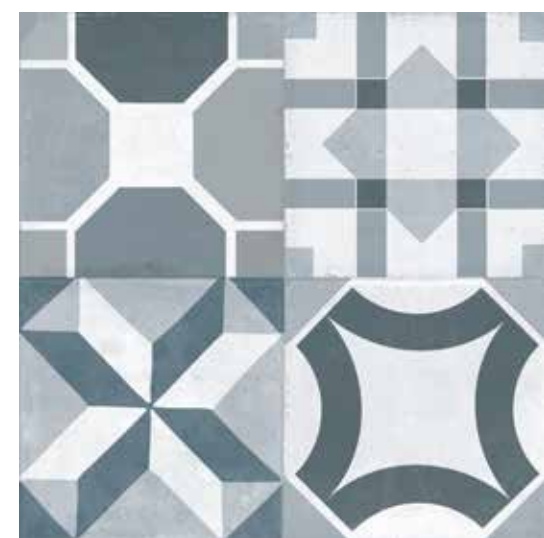
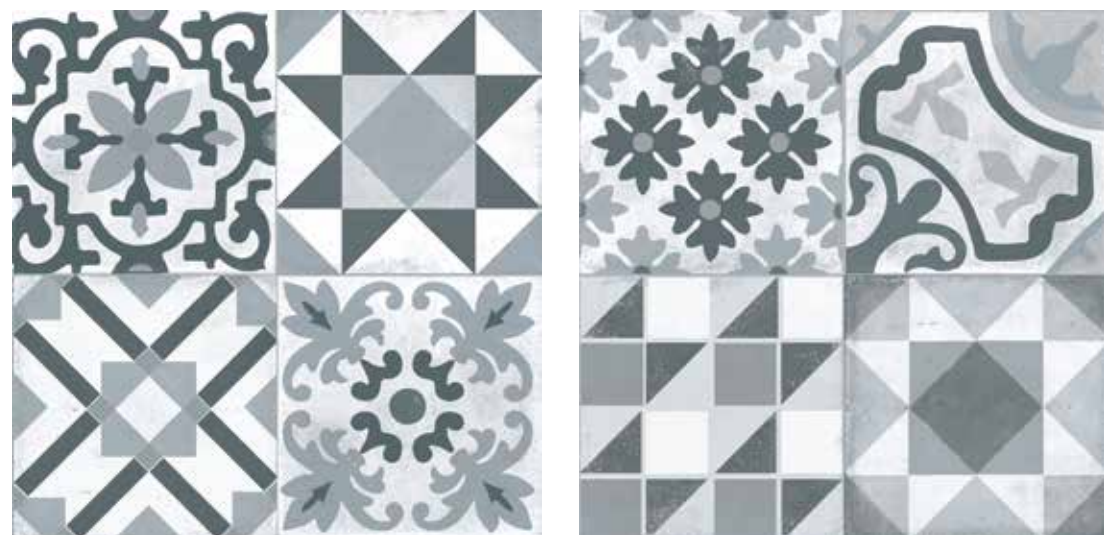

HERITAGE MIX GREY
GP 0492

HERITAGE MIX COLOR

GLAZED PORCELAIN TILES _GRÉS PORCELÂNICO VIDRADO _GRÈS CÉRAME ÉMAILLÉ
FEINSTEINZEUG GLASIERT _GRÉS PORCELÂNICO
EN 14411:2016 GROUP _GRUPO _GROUPE _GRUPPE Bla



HERITAGE MIX COLOR
GP 0493

SURFACE _SUPERFÍCIE

MATT

FEATURES _ATRIBUTOS

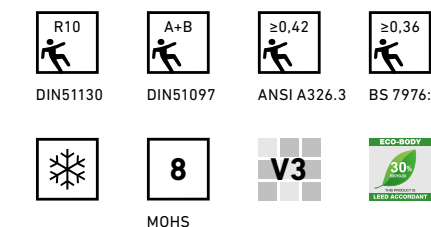

FINISH _ACABAMENTO

NATURAL (NAT)
PRE-CUT

SIZES _FORMATOS

40X40 NAT

PEÇAS EMBALADAS ALEATORIAMENTE POR CAIXA
TILES ARE PACKED RANDOMLY IN THE SAME BOX

FORM

 GLAZED PORCELAIN TILES _GRÉS PORCELÂNICO VIDRADO _GRÈS CÉRAMÉ ÉMAILLÉ
 FEINSTEINZEUG GLASIERT _GRÉS PORCELÂNICO
 EN 14411:2016 GROUP _GRUPO _GROUPE _GRUPPE Bla



30X60 / 12"X24"

▼
8,7 MM
▲

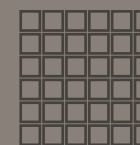

MOSAICO 4,7X4,7
30X30



MOSAICO LOSANGO
23,6X28

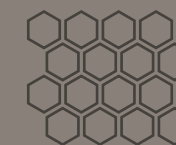

MOSAICO HEXAGONAL
26X31,5

USAGE _USO

WALL, FLOOR, INTERIOR, EXTERIOR, COMMERCIAL, RESIDENTIAL



FORM WHITE



FORM FOG



FORM NUT



FORM SMOKE

FORM FOG 30X60
BETON FOG 60X60



FORM WHITE 30X60

FORM

 **GLAZED PORCELAIN TILES** _GRÉS PORCELÂNICO VIDRADO _GRÈS CÉRAME ÉMAILLÉ
 **FEINSTEINZEUG GLASIERT** _GRÉS PORCELÂNICO
 EN 14411:2016 GROUP _GRUPO _GROUPE _GRUPPE Bla



FORM WHITE
GP 0442



FORM FOG
GP 0443



FORM NUT
GP 0444



FORM SMOKE
GP 0445

SURFACE _SUPERFÍCIE

MATT

FEATURES _ATRIBUTOS

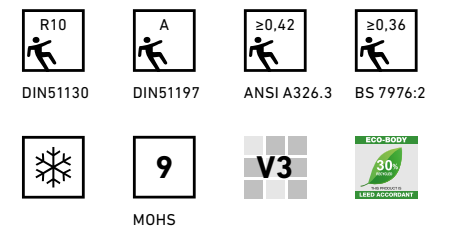

FINISH _ACABAMENTO

NATURAL (NAT)
RECTIFIED (R)

SIZES _FORMATOS

30X60 R
30X60 NAT

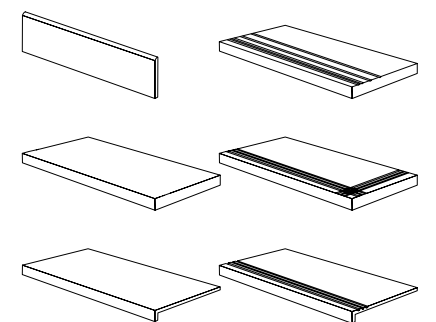

SKIRTINGS _RODAPÉ 9X60
STEP _DEGRAU 30X60
STEP _DEGRAU TEC. 30X60



FORM NUT 30X60
MOSAICO FORM NUT 4,7X4,7

MATRIX

 **GLAZED PORCELAIN TILES** _GRÉS PORCELÂNICO VIDRADO _GRÈS CÉRAMÉ ÉMAILLÉ
 **FEINSTEINZEUG GLASIERT** _GRÉS PORCELÂNICO
 EN 14411:2016 GROUP _GRUPO _GROUPE _GRUPPE **BIa**

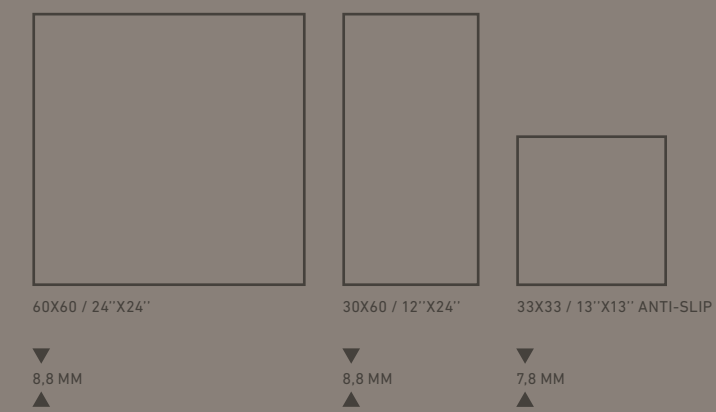

USAGE _USO

WALL, FLOOR, INTERIOR, COMMERCIAL, RESIDENTIAL / EXTERIOR ONLY 33X33 ANTI-SLIP



MATRIX PISTACHIO 60X60

MATRIX

 **GLAZED PORCELAIN TILES** _GRÉS PORCELÂNICO VIDRADO _GRÈS CÉRAME ÉMAILLÉ
 **FEINSTEINZEUG GLASIERT** _GRÉS PORCELÂNICO
 EN 14411:2016 GROUP _GRUPO _GROUPE _GRUPPE Bla

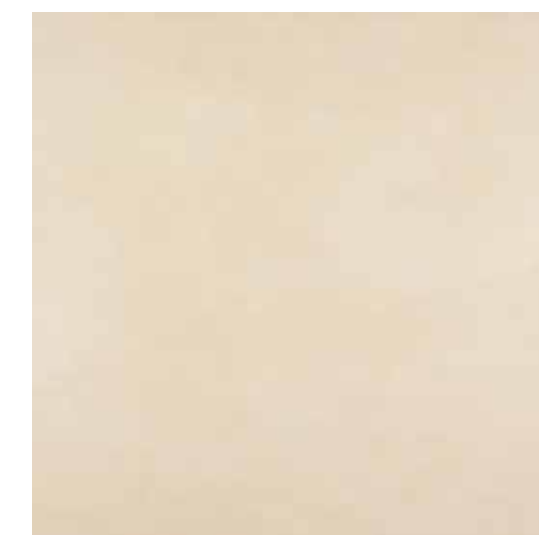

MATRIX BEGE
GP 0352

MATRIX BEGE ANTI-SLIP
GP 0475



MATRIX PISTACHIO
GP 0354

MATRIX PISTACHIO ANTI-SLIP
GP 0477



MATRIX ESTANHO
GP 0355

MATRIX ESTANHO ANTI-SLIP
GP 0478

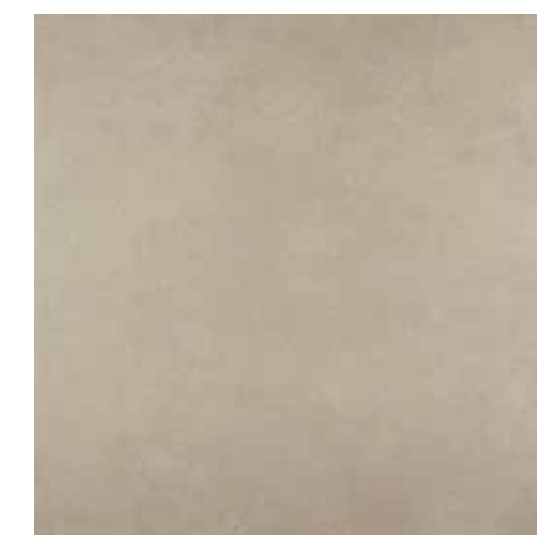

MATRIX NOZ
GP 0356

MATRIX NOZ ANTI-SLIP
GP 0479

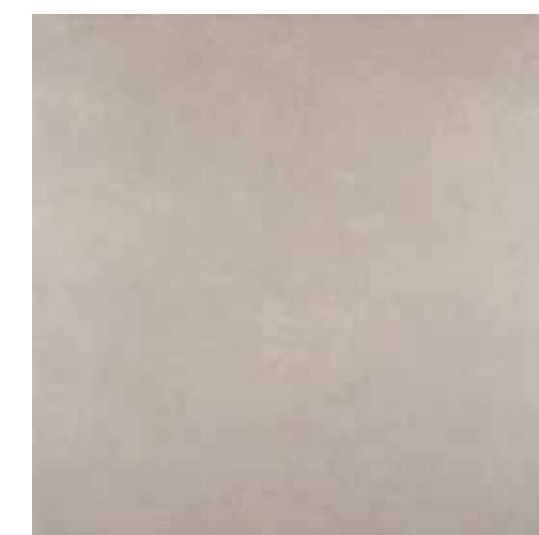

MATRIX CINZA
GP 0353

MATRIX CINZA ANTI-SLIP
GP 0476

SURFACE _SUPERFÍCIE

MATT

FEATURES _ATRIBUTOS

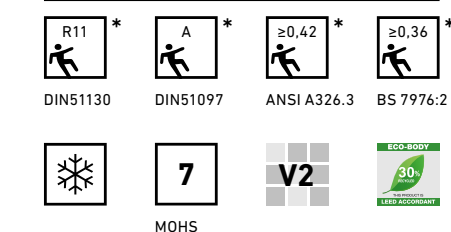

FINISH _ACABAMENTO

NATURAL (NAT)
RECTIFIED (R)

SIZES _FORMATOS

60X60 R
60X60 NAT
30X60 R
33X33 ANTI-SLIP*

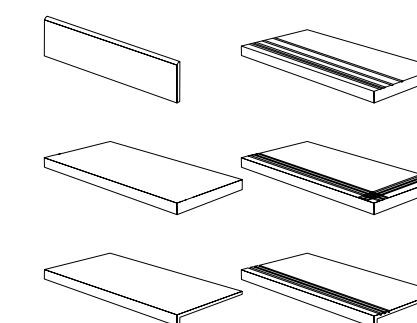

SKIRTINGS _RODAPE 9X60

SKIRTINGS _RODAPE 8X33

STEP _DEGRAU 60X60

STEP _DEGRAU 33X33

STEP _DEGRAU TEC. 30X60

AVANT

GLAZED PORCELAIN TILES _GRÉS PORCELÂNICO VIDRADO _GRÈS CÉRAME ÉMAILLÉ
FEINSTEINZEUG GLASIERT _GRÉS PORCELÂNICO
EN 14411:2016 GROUP _GRUPO _GROUPE _GRUPPE Bla

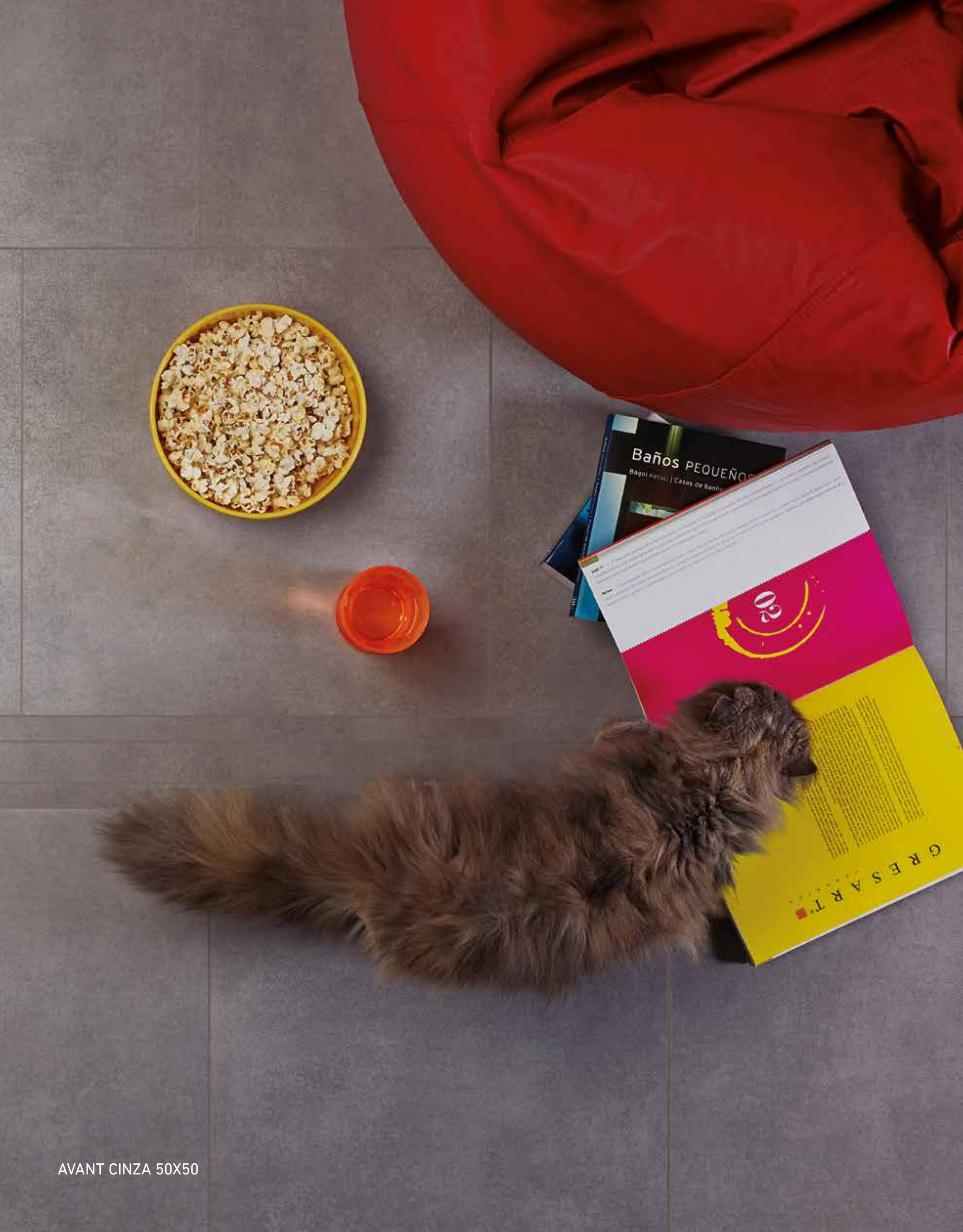

50X50 / 20"X20"

▼
9,5 MM
▲

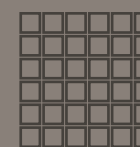

MOSAICO 5,3X5,3
30X30

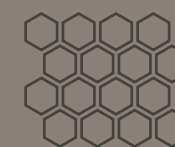

MOSAICO HEXAGONAL
26X31,5

USAGE _USO

WALL, FLOOR, INTERIOR, COMMERCIAL, RESIDENTIAL



AVANT BEGE



AVANT NOZ



AVANT CINZA



AVANT BRONZE



AVANT CASTANHO



AVANT PRETO



AVANT

GLAZED PORCELAIN TILES _GRÉS PORCELÂNICO VIDRADO _GRÈS CÉRAME ÉMAILLÉ
FEINSTEINZEUG GLASIERT _GRÉS PORCELÂNICO
EN 14411:2016 GROUP _GRUPO _GROUPE _GRUPPE Bla



AVANT BEGE
GP 0322



AVANT NOZ
GP 0323



AVANT CINZA
GP 0321



AVANT BRONZE
GP 0324



AVANT CASTANHO
GP 0325



AVANT PRETO
GP 0326

SURFACE _SUPERFÍCIE

MATT SATINE

FEATURES _ATRIBUTOS

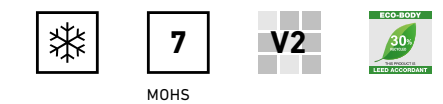

FINISH _ACABAMENTO

NATURAL (NAT)

SIZES _FORMATOS

50X50 NAT

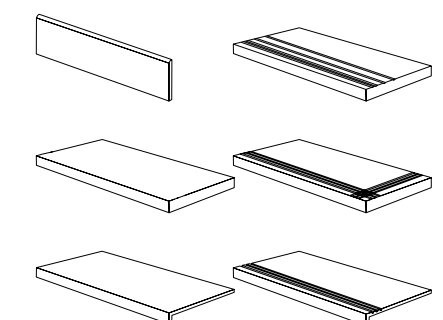

SKIRTINGS _RODAPÉ 8X50
STEP _DEGRAU 50X50
STEP _DEGRAU TEC. 30X50

TERRAZZO

 **GLAZED PORCELAIN TILES** _GRÉS PORCELÂNICO VIDRADO _GRÈS CÉRAMÉ ÉMAILLÉ
 **FEINSTEINZEUG GLASIERT** _GRÉS PORCELÂNICO
 EN 14411:2016 GROUP _GRUPO _GROUPE _GRUPPE **Bl**a

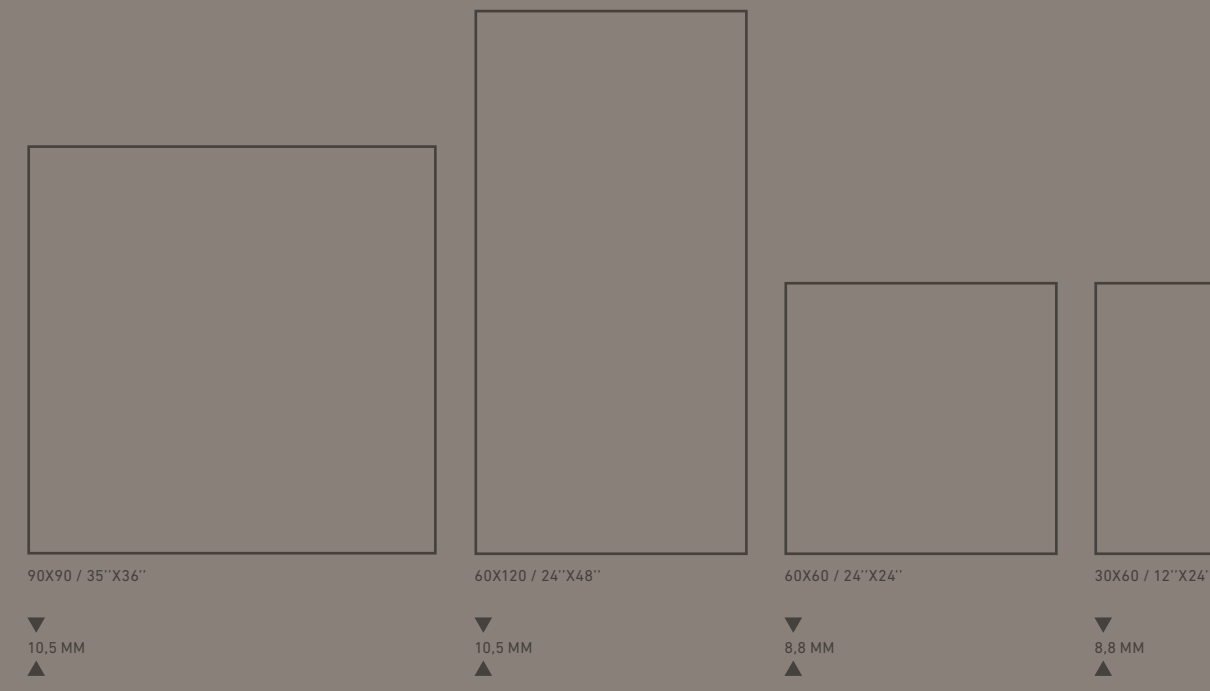

USAGE _USO
 WALL, FLOOR, INTERIOR, EXTERIOR, COMMERCIAL, RESIDENTIAL



TERRAZZO WHITE TERRAZZO GREY TERRAZZO TORTORA TERRAZZO SMOKE

TERRAZZO GREY 60X60 R



TERRAZZO SMOKE 60X60 R
TERRAZZO TORTORA 60X60 R

TERRAZZO

 **GLAZED PORCELAIN TILES** _GRÉS PORCELÂNICO VIDRADO _GRÈS CÉRAME ÉMAILLÉ
 **FEINSTEINZEUG GLASIERT** _GRÉS PORCELÂNICO
 EN 14411:2016 GROUP _GRUPO _GROUPE _GRUPPE Bla



TERRAZZO GREY 90X90 R



TERRAZZO WHITE
GP 0691



TERRAZZO GREY
GP 0676



TERRAZZO TORTORA
GP 0677

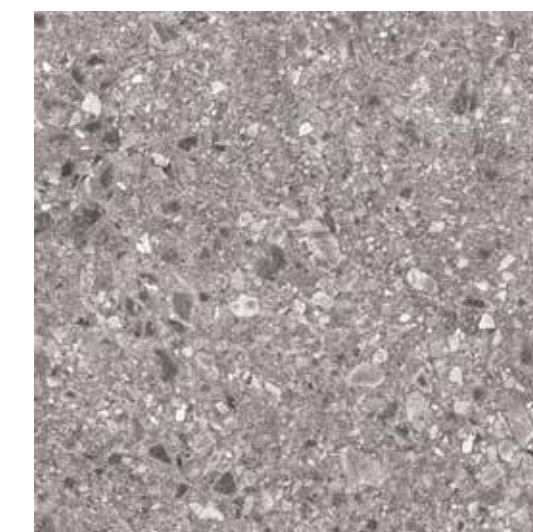

TERRAZZO SMOKE
GP 0678

SURFACE _SUPERFÍCIE

MATT
SEMI-POLISHED (SP)

FEATURES _ATRIBUTOS

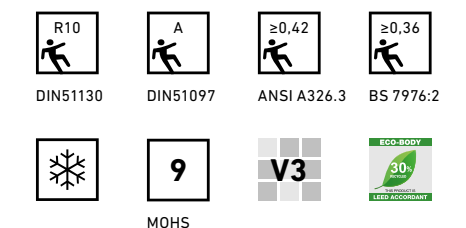

FINISH _ACABAMENTO

NATURAL (NAT)
RECTIFIED (R)

SIZES _FORMATOS

90X90 R
 90X90 SP
 45X90 R
 45X90 SP
 60X120 R
 60X120 SP
 60X60 R
 60X60 SP
 60X60 NAT
 30X60 R
 30X60 SP

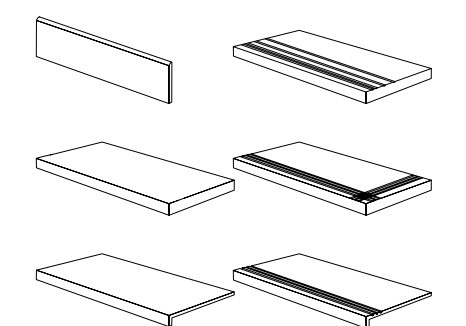

SKIRTINGS _RODAPÉ 9X90
 SKIRTINGS _RODAPÉ 9X120
 SKIRTINGS _RODAPÉ 9X60
 STEP _DEGRAU 45X90
 STEP _DEGRAU 60X120
 STEP _DEGRAU 60X60
 STEP _DEGRAU TEC. 30X90
 STEP _DEGRAU TEC. 30X120
 STEP _DEGRAU TEC. 30X60

BEDROCK

GLAZED PORCELAIN TILES _GRÉS PORCELÂNICO VIDRADO _GRÈS CÉRAMÉ ÉMAILLÉ
FEINSTEINZEUG GLASIERT _GRÉS PORCELÂNICO
EN 14411:2016 GROUP _GRUPO _GROUPE _GRUPPE Bla



BEDROCK FOG 90X90 R
BEDROCK FOG 60X120 R

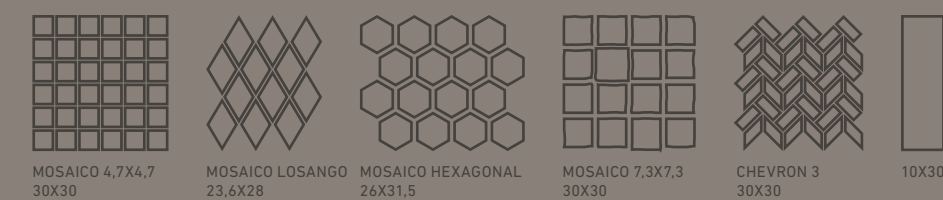
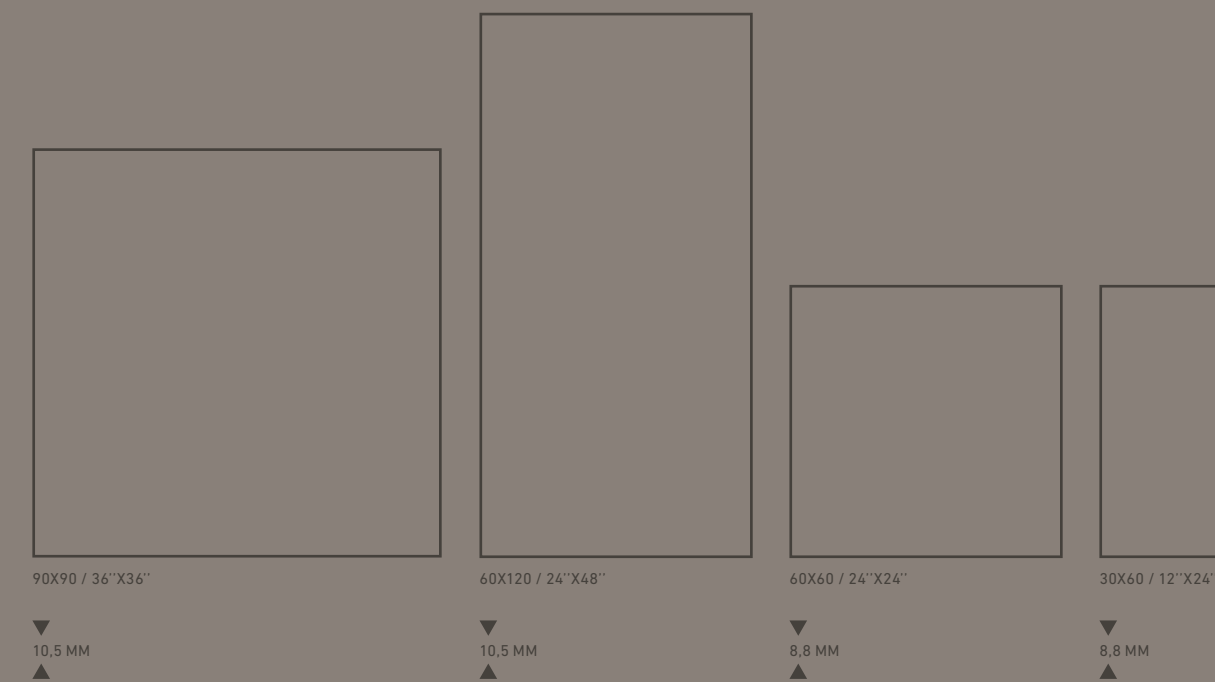

USAGE _USO

WALL, FLOOR, INTERIOR, COMMERCIAL, RESIDENTIAL

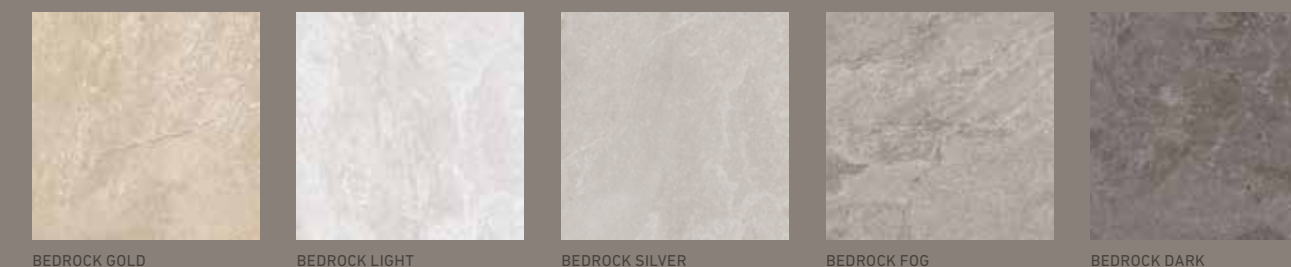

BEDROCK GOLD BEDROCK LIGHT BEDROCK SILVER BEDROCK FOG BEDROCK DARK



BEDROCK FOG 60X120 R



BEDROCK

 **GLAZED PORCELAIN TILES** _GRÉS PORCELÂNICO VIDRADO _GRÈS CÉRAME ÉMAILLÉ
 **FEINSTEINZEUG GLASIERT** _GRÉS PORCELÂNICO
 EN 14411:2016 GROUP _GRUPO _GROUPE _GRUPPE Bla



BEDROCK DARK 60X120 R
VERMONT BROWN 20X120



BEDROCK GOLD
GP 0693



BEDROCK LIGHT
GP 0692



BEDROCK SILVER
GP 0694



BEDROCK FOG
GP 0695



BEDROCK DARK
GP 0696

SURFACE _SUPERFÍCIE

MATT

FEATURES _ATRIBUTOS

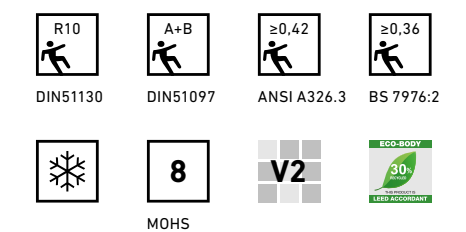

FINISH _ACABAMENTO

NATURAL (NAT)
RECTIFIED (R)

SIZES _FORMATOS

90X90 R
45X90 R
60X120 R
60X60 R
60X60 NAT
30X60 R
30X60 NAT

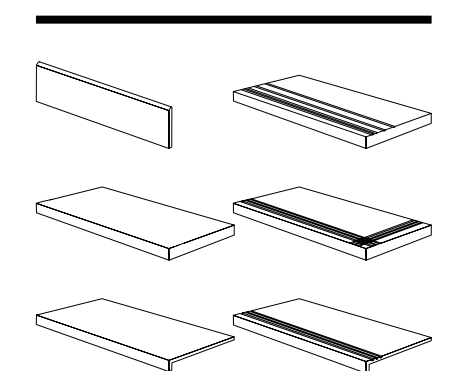

SKIRTINGS _RODAPÉ 9X90
SKIRTINGS _RODAPÉ 9X120
SKIRTINGS _RODAPÉ 9X60
STEP _DEGRAU 45X90
STEP _DEGRAU 60X120
STEP _DEGRAU 60X60
STEP _DEGRAU TEC. 30X90
STEP _DEGRAU TEC. 30X120
STEP _DEGRAU TEC. 30X60

BEDROCK

MOLEANOS

GLAZED PORCELAIN TILES _GRÉS PORCELÂNICO VIDRADO _GRÈS CÉRAME ÉMAILLÉ
FEINSTEINZEUG GLASIERT _GRÉS PORCELÂNICO
EN 14411:2016 GROUP _GRUPO _GROUPE _GRUPPE Bla



MOLEANOS CREAM 60X60 R
MOLEANOS LINES CREAM 30X60
MOSAICO MOLEANOS CREAM 4,7X4,7



MOLEANOS WHITE
GP 0525

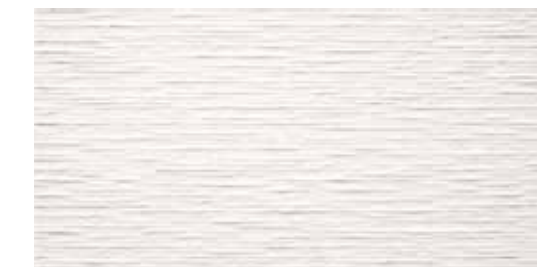

MOLEANOS LINES WHITE
GP 0640



MOLEANOS GREY
GP 0526



MOLEANOS LINES GREY
GP 0641



MOLEANOS CREAM
GP 0527



MOLEANOS LINES CREAM
GP 0642

SURFACE _SUPERFÍCIE

MATT
SEMI-POLISHED (SP)

FEATURES _ATRIBUTOS

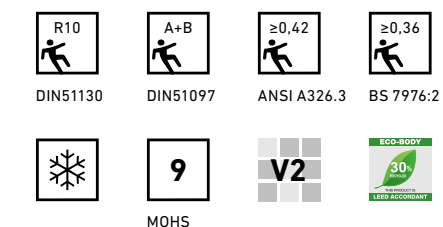

FINISH _ACABAMENTO

NATURAL (NAT)
RECTIFIED (R)

SIZES _FORMATOS THICKNESS _ESPESSURA

60X60 R	8,8 MM
60X60 SP	
60X60 NAT	
30X60 R	8,8 MM
30X60 SP	
30X60 NAT	

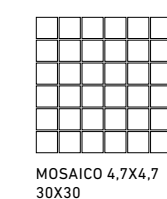
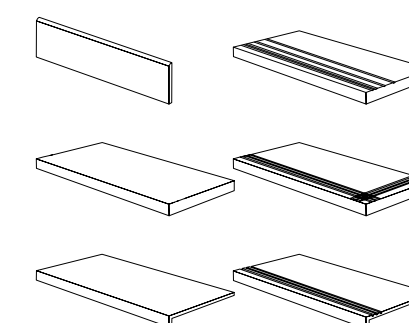

MOSAICO 4,7X4,7
30X30

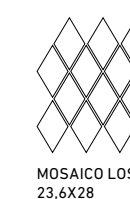

MOSAICO LOSANGO
23,6X28



MOSAICO HEXAGONAL
26X31,5

SKIRTINGS _RODAPE 9X60
STEP _DEGRAU 60X60
STEP _DEGRAU TEC. 30X60

SANDSTONE

 **GLAZED PORCELAIN TILES** _GRÉS PORCELÂNICO VIDRADO _GRÈS CÉRAME ÉMAILLÉ
 **FEINSTEINZEUG GLASIERT** _GRÉS PORCELÂNICO
 EN 14411:2016 GROUP _GRUPO _GROUPE _GRUPPE Bla



60X60 / 24"X24"

30X60 / 12"X24"

▼
8,8 MM
▲

▼
8,8 MM
▲

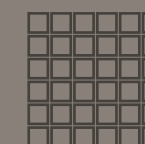

MOSAICO 4,7X4,7
30X30



MOSAICO LOSANGO
23,6X28



MOSAICO HEXAGONAL
26X31,5

USAGE _USO

WALL, FLOOR, INTERIOR, EXTERIOR, COMMERCIAL, RESIDENTIAL



SANDSTONE ASH



SANDSTONE BONE



SANDSTONE FOG



SANDSTONE SMOKE



SANDSTONE FOG 60X60 R

SANDSTONE

 **GLAZED PORCELAIN TILES** _GRÉS PORCELÂNICO VIDRADO _GRÈS CÉRAME ÉMAILLÉ
 **FEINSTEINZEUG GLASIERT** _GRÉS PORCELÂNICO
 EN 14411:2016 GROUP _GRUPO _GROUPE _GRUPPE Bla



SANDSTONE FOG 60X60



SANDSTONE ASH
GP 0531



SANDSTONE BONE
GP 0530



SANDSTONE FOG
GP 0532



SANDSTONE SMOKE
GP 0533

SURFACE _SUPERFÍCIE

MATT

FEATURES _ATRIBUTOS

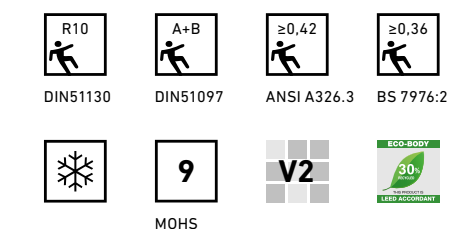

FINISH _ACABAMENTO

NATURAL
RECTIFIED

SIZES _FORMATOS

60X60 R
 60X60 NAT
 30X60 R
 30X60 NAT

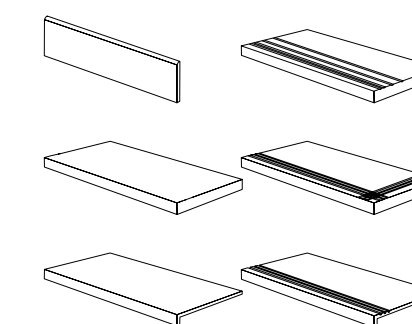

SKIRTINGS _RODAPÉ 9X60
 STEP _DEGRAU 60X60
 STEP _DEGRAU TEC. 30X60

SANDSTONE LINES&SQUARES

 **GLAZED PORCELAIN TILES** _GRÉS PORCELÂNICO VIDRADO _GRÈS CÉRAME ÉMAILLÉ
FEINSTEINZEUG GLASIERT _GRÉS PORCELÁNICO
EN 14411:2016 GROUP _GRUPO _GROUPE _GRUPPE Bla



LINES LIGHT
GP 0606



LINES DARK
GP 0607



SQUARES LIGHT
GP 0608



SQUARES DARK
GP 0609

SURFACE _SUPERFÍCIE

MATT

FEATURES _ATRIBUTOS



FINISH _ACABAMENTO

NATURAL (NAT)

SIZES _FORMATOS

30X60 NAT



LINES DARK 30X60
SANDSTONE FOG 60X60

ARDÓSIA

GLAZED PORCELAIN TILES _GRÉS PORCELÂNICO VIDRADO _GRÈS CÉRAME ÉMAILLÉ
FEINSTEINZEUG GLASIERT _GRÉS PORCELÂNICO
EN 14411:2016 GROUP _GRUPO _GROUPE _GRUPPE Bla

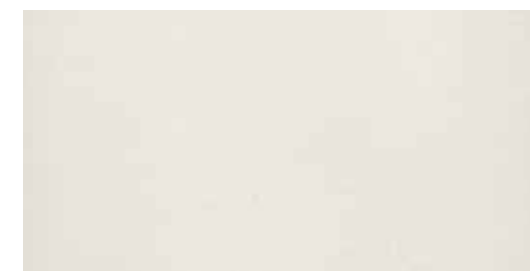

ARDÓSIA PÉROLA
GP 0231



ARDÓSIA CINZA
GP 0232



ARDÓSIA PRETO
GP 0233

SURFACE _SUPERFÍCIE

MATT

FEATURES _ATRIBUTOS



MOHS

FINISH _ACABAMENTO

NATURAL (NAT)

SIZES _FORMATOS

THICKNESS _ESPESSURA

30X60 NAT	8,7 MM
33X33 NAT	7,8 MM

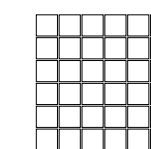
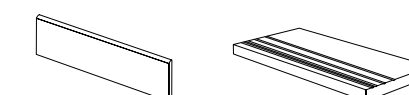

MOSAICO 5,3X5,3
33X33

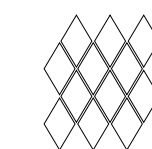

MOSAICO LOSANGO
23,6X28

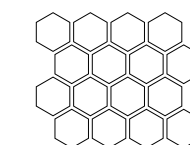

MOSAICO HEXAGONAL
26X31,5

SKIRTINGS _RODAPÉ 9X60

SKIRTINGS _RODAPÉ 8X33

STEP _DEGRAU 30X60

STEP _DEGRAU 33X33

RORIZ

GLAZED PORCELAIN TILES _GRÉS PORCELÂNICO VIDRADO _GRÈS CÉRAME ÉMAILLÉ
FEINSTEINZEUG GLASIERT _GRÉS PORCELÂNICO
EN 14411:2016 GROUP _GRUPO _GROUPE _GRUPPE Bla



RORIZ CINZA
GP 0624



RORIZ BEGE
GP 0625



RORIZ PRAGAL
GP 0626

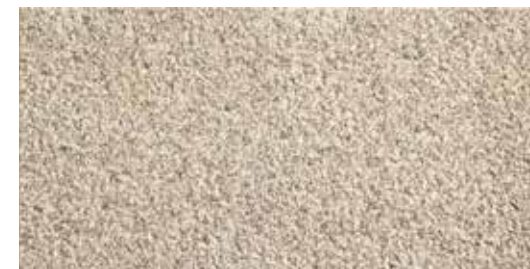

RORIZ REAL
GP 0627

SURFACE _SUPERFÍCIE

MATT ROUGH

FEATURES _ATRIBUTOS

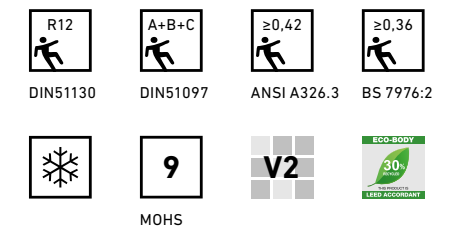

FINISH _ACABAMENTO

NATURAL (NAT)

SIZES _FORMATOS THICKNESS _ESPESSURA

30X60 NAT ANTI-SLIP 8,7 MM
33X33 NAT ANTI-SLIP 7,8 MM

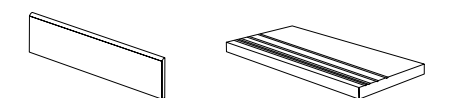

SKIRTINGS _RODAPÉ 8X33
STEP _DEGRAU 33X33

SLATE

 **GLAZED PORCELAIN TILES** _GRÉS PORCELÂNICO VIDRADO _GRÈS CÉRAME ÉMAILLÉ
 **FEINSTEINZEUG GLASIERT** _GRÉS PORCELÂNICO
 EN 14411:2016 GROUP _GRUPO _GROUPE _GRUPPE Bla



SLATE BRANCO
GP 0365



SLATE PRETO
GP 0366



SLATE MULTICOLOR
GP 0367

SURFACE _SUPERFÍCIE

MATT

FEATURES _ATRIBUTOS

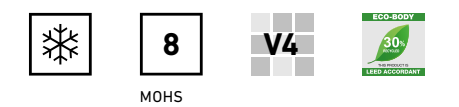
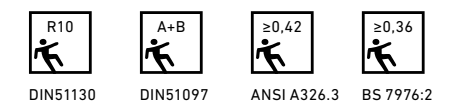

FINISH _ACABAMENTO

NATURAL (NAT)

SIZES _FORMATOS THICKNESS _ESPESSURA

30X60 NAT 8,7 MM

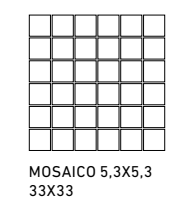
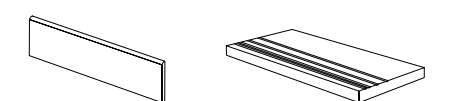

SKIRTINGS _RODAPE 9X60
STEP _DEGRAU 30X60

BRICK

GLAZED PORCELAIN TILES _GRÉS PORCELÂNICO VIDRADO _GRÈS CÉRAME ÉMAILLÉ
FEINSTEINZEUG GLASIERT _GRÉS PORCELÁNICO
EN 14411:2016 GROUP _GRUPO _GROUPE _GRUPPE Bla

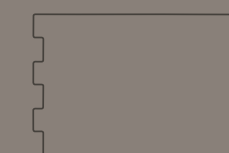

33X47 / 13"18"

▼
9,5 MM
▲

USAGE _USO

WALL, INTERIOR, EXTERIOR, COMMERCIAL, RESIDENTIAL



BRICK BRANCO



BRICK CINZA



BRICK BEGE



BRICK CASTANHO



BRICK PARDO



BRICK PRETO

BRICK BRANCO 33X47
BETON WHITE 60X60





BRICK CINZA 33X47

BRICK

 **GLAZED PORCELAIN TILES** _GRÉS PORCELÂNICO VIDRADO _GRÈS CÉRAMÉ ÉMAILLÉ
FEINSTEINZEUG GLASIERT _GRÉS PORCELÁNICO
EN 14411:2016 GROUP _GRUPO _GROUPE _GRUPPE Bla



BRICK BRANCO
GP 0446



BRICK CINZA
GP 0447



BRICK BEGE
GP 0448



BRICK CASTANHO
GP 0449



BRICK PARDO
GP 0450



BRICK PRETO
GP 0451

SURFACE _SUPERFÍCIE

MATT

FEATURES _ATRIBUTOS



FINISH _ACABAMENTO

NATURAL (NAT)

SIZES _FORMATOS

33X47 NAT



LINEA

GLAZED PORCELAIN TILES _GRÉS PORCELÂNICO VIDRADO _GRÈS CÉRAME ÉMAILLÉ
FEINSTEINZEUG GLASIERT _GRÉS PORCELÂNICO
EN 14411:2016 GROUP _GRUPO _GROUPE _GRUPPE Bla

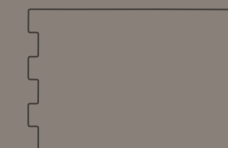

33X47 / 13"18"

▼
9,5 MM
▲

USAGE _USO

WALL, INTERIOR, EXTERIOR, COMMERCIAL, RESIDENTIAL



LINEA CINZA



LINEA BEGE



LINEA MIX CINZA



LINEA MIX BEGE



LINEA MULTICOLOR



LINEA MIX BEGE 33X47

LINEA

 **GLAZED PORCELAIN TILES** _GRÉS PORCELÂNICO VIDRADO _GRÈS CÉRAME ÉMAILLÉ
FEINSTEINZEUG GLASIERT _GRÉS PORCELÂNICO
EN 14411:2016 GROUP _GRUPO _GROUPE _GRUPPE Bla



LINEA CINZA
GP 0461



LINEA BEGE
GP 0462



LINEA MIX CINZA
GP 0463



LINEA MIX BEGE
GP 0464



LINEA MULTICOLOR
GP 0469

SURFACE _SUPERFÍCIE

MATT

FEATURES _ATRIBUTOS



FINISH _ACABAMENTO

NATURAL (NAT)

SIZES _FORMATOS

33X47 NAT

LINEA VINTAGE_CLASSIC

GLAZED PORCELAIN TILES _GRÉS PORCELÂNICO VIDRADO _GRÈS CÉRAME ÉMAILLÉ
FEINSTEINZEUG GLASIERT _GRÉS PORCELÁNICO
EN 14411:2016 GROUP _GRUPO _GROUPE _GRUPPE Bla



33X47 / 13"18"

▼
9,5 MM
▲

USAGE _USO

WALL, INTERIOR, EXTERIOR, COMMERCIAL, RESIDENTIAL



LINEA VINTAGE



LINEA CLASSIC

LINEA VINTAGE 33X47
VINTAGE MULTICOLOR 15X60

ception



BRICK BEGE 33X47
LINEA CLASSIC 33X47

LINEA VINTAGE_CLASSIC

 **GLAZED PORCELAIN TILES** _GRÉS PORCELÂNICO VIDRADO _GRÈS CÉRAMÉ ÉMAILLÉ
FEINSTEINZEUG GLASIERT _GRÉS PORCELÁNICO
EN 14411:2016 GROUP _GRUPO _GROUPE _GRUPPE Bla



LINEA VINTAGE
GP 0465



LINEA CLASSIC
GP 0466

SURFACE _SUPERFÍCIE

MATT

FEATURES _ATRIBUTOS



FINISH _ACABAMENTO

NATURAL (NAT)

SIZES _FORMATOS

33X47 NAT

COTTO

GLAZED PORCELAIN TILES _GRÉS PORCELÂNICO VIDRADO _GRÈS CÉRAMÉ ÉMAILLÉ
FEINSTEINZEUG GLASIERT _GRÉS PORCELÂNICO
EN 14411:2016 GROUP _GRUPO _GROUPE _GRUPPE Bla



33X33 / 13"X13"

▼
7,8 MM
▲

USAGE _USO

WALL, FLOOR, INTERIOR, COMMERCIAL, RESIDENTIAL / EXTERIOR ONLY ANTI-SLIP



COTTO GREY



COTTO BEGE



COTTO BROWN





COTTO

 **GLAZED PORCELAIN TILES** _GRÉS PORCELÂNICO VIDRADO _GRÈS CÉRAMÉ ÉMAILLÉ
 **FEINSTEINZEUG GLASIERT** _GRÉS PORCELÁNICO
 EN 14411:2016 GROUP _GRUPO _GROUPE _GRUPPE Bla



COTTO GREY
GP 0505

COTTO GREY ANTI-SLIP
GP 0508



COTTO BEGE
GP 0506

COTTO BEGE ANTI-SLIP
GP 0509



COTTO BROWN
GP 0507

COTTO BROWN ANTI-SLIP
GP 0510

SURFACE _SUPERFÍCIE

MATT

FEATURES _ATRIBUTOS

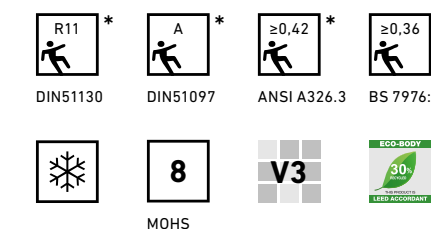

FINISH _ACABAMENTO

NATURAL (NAT)

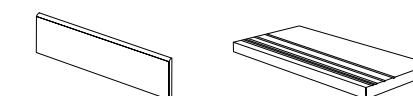

SIZES _FORMATOS

33X33 NAT
33X33 NAT ANTI-SLIP*



SKIRTINGS _RODAPÉ 8X3
STEP _DEGRAU 33X33

MIX&MATCH

 GLAZED PORCELAIN TILES _GRÉS PORCELÂNICO VIDRADO _GRÈS CÉRAMÉ ÉMAILLÉ
 FEINSTEINZEUG GLASIERT _GRÉS PORCELÂNICO
 EN 14411:2016 GROUP _GRUPO _GROUPE _GRUPPE Bla



MIX&MATCH CREAM 60X60 R

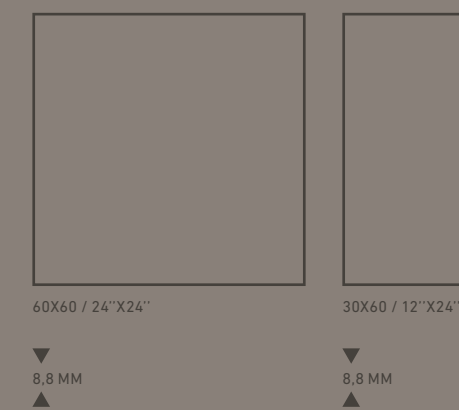

USAGE _USO

WALL, FLOOR, INTERIOR, COMMERCIAL, RESIDENTIAL





MIX&MATCH

 **GLAZED PORCELAIN TILES** _GRÉS PORCELÂNICO VIDRADO _GRÈS CÉRAME ÉMAILLÉ
 **FEINSTEINZEUG GLASIERT** _GRÉS PORCELÂNICO
 EN 14411:2016 GROUP _GRUPO _GROUPE _GRUPPE Bla



MIX&MATCH DECOR 30X60 R

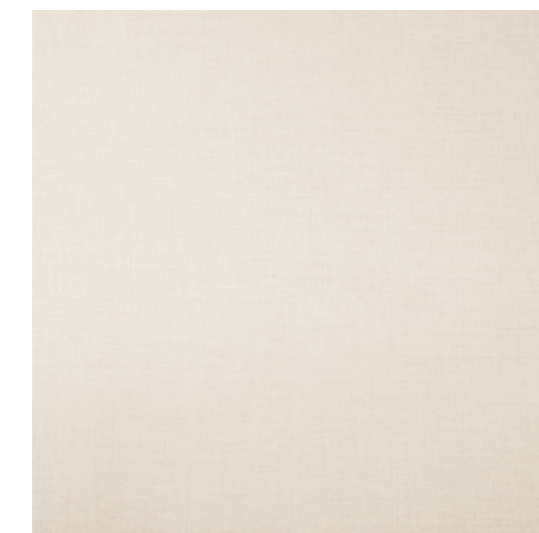

MIX&MATCH WHITE
GP 0585



MIX&MATCH CREAM
GP 0605



MIX&MATCH GREY
GP 0586



MIX&MATCH TORTORA
GP 0587



MIX&MATCH BROWN
GP 0588



MIX&MATCH DECOR
GP 0589



MIX&MATCH SQUARE MIX
GP 0590

SURFACE _SUPERFÍCIE

MATT

FEATURES _ATRIBUTOS



FINISH _ACABAMENTO

NATURAL (NAT)
RECTIFIED (R)

SIZES _FORMATOS

60X60 R
60X60 NAT
30X60 R
30X60 NAT (SQUARES)

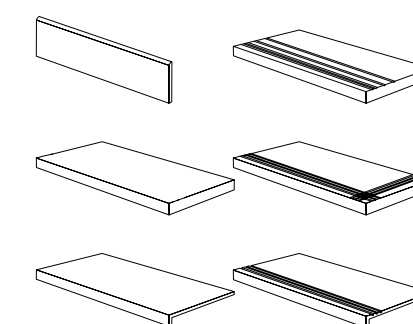

SKIRTINGS _RODAPÉ 9X60
STEP _DEGRAU 60X60
STEP _DEGRAU TEC. 30X60

MIX&MATCH

 **WHITE BODY WALL TILES** _REVESTIMENTOS EM PASTA BRANCA _CARREAUX DE MUR EN PATE BLANCHE
WEISSEN TON WANDFLIESEN _REVESTIMIENTOS EN PASTA BLANCA
EN 14411:2016 GROUP _GRUPO _GROUPE _GRUPPE BIII



MIX&MATCH WHITE
GM 0585



MIX&MATCH DECOR BIRDS WHITE
GM 0610



MIX&MATCH CREAM
GM 0605



MIX&MATCH DECOR BIRDS CREAM
GM 0614



MIX&MATCH GREY
GM 0586



MIX&MATCH DECOR BIRDS GREY
GM 0611



MIX&MATCH TORTORA
GM 0587



MIX&MATCH DECOR BIRDS TORTORA
GM 0612



MIX&MATCH BROWN
GM 0588



MIX&MATCH DECOR BIRDS BROWN
GM 0613

SURFACE _SUPERFÍCIE

MATT

FEATURES _ATRIBUTOS



FINISH _ACABAMENTO

NATURAL (NAT)
RECTIFIED (R)

SIZES _FORMATOS

30X60 R
30X60 NAT

MIX&MATCH DECOR BIRDS WHITE 30X60
MIX&MATCH GREY 60X60

METALLICA

 GLAZED PORCELAIN TILES _GRÉS PORCELÂNICO VIDRADO _GRÈS CÉRAMÉ ÉMAILLÉ
 FEINSTEINZEUG GLASIERT _GRÉS PORCELÂNICO
 EN 14411:2016 GROUP _GRUPO _GROUPE _GRUPPE **Bl**a

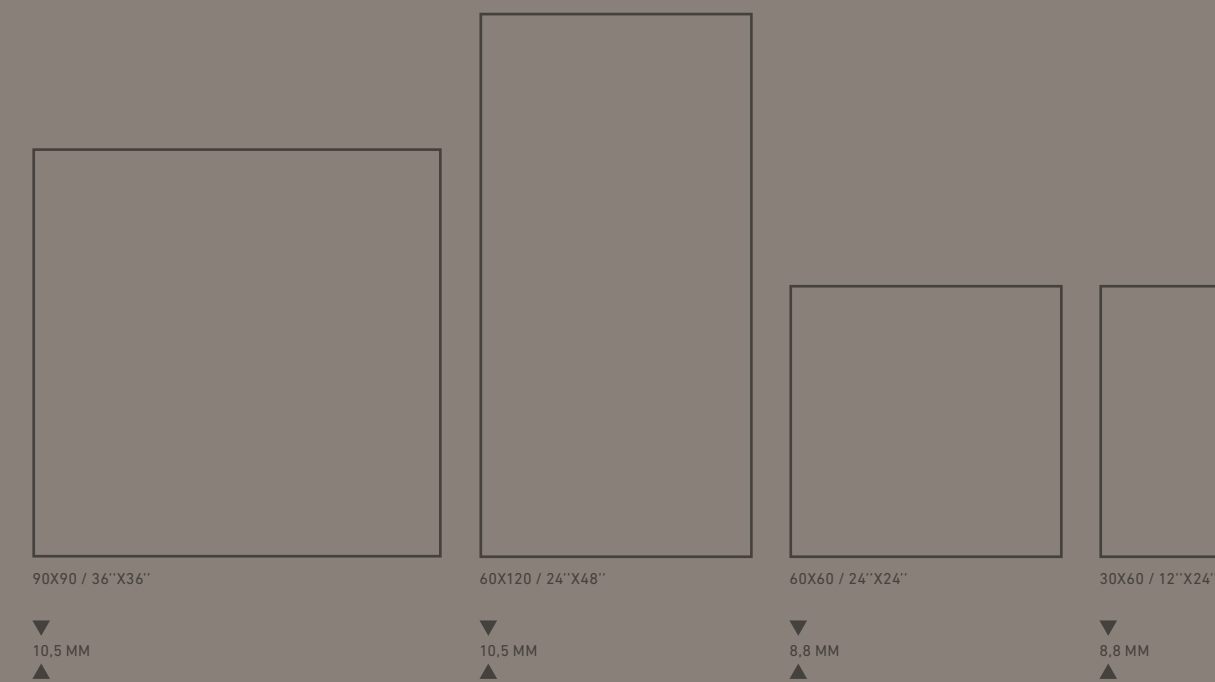

USAGE _USO

WALL, FLOOR, INTERIOR, COMMERCIAL, RESIDENTIAL



METALLICA TITAN 60X120
 METALLICA TITAN 90X90



THE
HOTEL

METALLICA TITAN 60X120
METALLICA SILVER 60X120
METALLICA SILVER 90X90

METALLICA

 **GLAZED PORCELAIN TILES** _GRÉS PORCELÂNICO VIDRADO _GRÈS CÉRAME ÉMAILLÉ
 FEINSTEINZEUG GLASIERT _GRÉS PORCELÂNICO
 EN 14411:2016 GROUP _GRUPO _GROUPE _GRUPPE Bla



METALLICA DECOR WHITE
GP 0714



METALLICA DECOR SILVER
GP 0715



METALLICA DECOR TITAN
GP 0716



METALLICA DECOR OXYD
GP 0717



METALLICA DECOR DARK
GP 0718

METALLICA

 **GLAZED PORCELAIN TILES** _GRÉS PORCELÂNICO VIDRADO _GRÈS CÉRAME ÉMAILLÉ
 FEINSTEINZEUG GLASIERT _GRÉS PORCELÂNICO
 EN 14411:2016 GROUP _GRUPO _GROUPE _GRUPPE Bla



METALLICA WHITE
GP 0671



METALLICA SILVER
GP 0672



METALLICA TITAN
GP 0673



METALLICA OXYD
GP 0674



METALLICA DARK
GP 0675

SURFACE _SUPERFÍCIE

MATT
SEMI-POLISHED (SP)

FEATURES _ATRIBUTOS

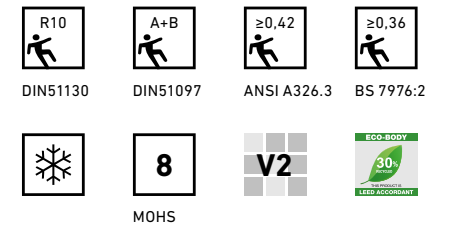

FINISH _ACABAMENTO

NATURAL (NAT)
RECTIFIED (R)

SIZES _FORMATOS

90X90 R
 90X90 SP
 45X90 R
 45X90 SP
 60X120 R
 60X120 SP
 60X60 R
 60X60 SP
 60X60 NAT
 30X60 R
 30X60 SP

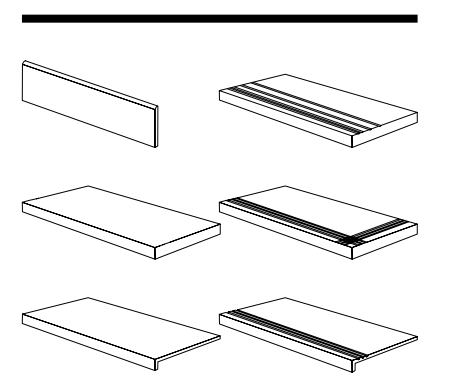

SKIRTINGS _RODAPÉ 9X90
 SKIRTINGS _RODAPÉ 9X120
 SKIRTINGS _RODAPÉ 9X60
 STEP _DEGRAU 45X90
 STEP _DEGRAU 60X120
 STEP _DEGRAU 60X60
 STEP _DEGRAU TEC. 30X90
 STEP _DEGRAU TEC. 30X120
 STEP _DEGRAU TEC. 30X60

METALLICA



METALLICA WHITE 30X90
METALLICA WHITE LINES 30X90
METALLICA TITAN QUADRI 30X90
METALLICA TITAN 90X90

METALLICA

 **WHITE BODY WALL TILES** _REVESTIMENTOS EM PASTA BRANCA _CARREAUX DE MUR EN PATE BLANCHE
WEISSEN TON WANDFLIESEN _REVESTIMIENTOS EN PASTA BLANCA
EN 14411:2016 GROUP _GRUPO _GROUPE _GRUPPE BIII



METALLICA WHITE
GM 0671



METALLICA SILVER
GM 0672



METALLICA TITAN
GM 0673



METALLICA OXYD
GM 0674



METALLICA DARK
GM 0675

SURFACE _SUPERFÍCIE

MATT

FEATURES _ATRIBUTOS



FINISH _ACABAMENTO

NATURAL (NAT)
RECTIFIED (R)

SIZES _FORMATOS THICKNESS _ESPESSURA

30X90 R	10,5 MM
30X90 NAT	
30X60 R	9,5 MM
30X60 NAT	



METALLICA TITAN 60X120 SP

METALLICA

 **WHITE BODY WALL TILES** _REVESTIMENTOS EM PASTA BRANCA _CARREAUX DE MUR EN PATE BLANCHE
WEISSEN TON WANDFLIESEN _REVESTIMENTOS EN PASTA BLANCA
EN 14411:2016 GROUP _GRUPO _GROUPE _GRUPPE BIII



METALLICA WHITE QUADRI
GM 0751



METALLICA WHITE LINES
GM 0756



METALLICA SILVER QUADRI
GM 0752



METALLICA SILVER LINES
GM 0757



METALLICA TITAN QUADRI
GM 0753



METALLICA TITAN LINES
GM 0758



METALLICA OXYD QUADRI
GM 0754



METALLICA OXYD LINES
GM 0759



METALLICA DARK QUADRI
GM 0755



METALLICA DARK LINES
GM 0760

SURFACE _SUPERFÍCIE

MATT

FEATURES _ATRIBUTOS



FINISH _ACABAMENTO

NATURAL (NAT)
RECTIFIED (R)

SIZES _FORMATOS
THICKNESS _ESPESSURA

30X90 R	10,5 MM
30X90 NAT	
30X60 R	9,5 MM
30X60 NAT	

METALLICA OXYD QUADRI 30X90 R

METALLICA

METALLICA

 **WHITE BODY WALL TILES** _REVESTIMENTOS EM PASTA BRANCA _CARREAUX DE MUR EN PATE BLANCHE
WEISSEN TON WANDFLIESEN _REVESTIMENTOS EN PASTA BLANCA
EN 14411:2016 GROUP _GRUPO _GROUPE _GRUPPE BIII



METALLICA WHITE
MOSAICO 4,7X4,7
30X30



METALLICA SILVER
MOSAICO 4,7X4,7
30X30



METALLICA TITAN
MOSAICO 4,7X4,7
30X30



METALLICA OXYD
MOSAICO 4,7X4,7
30X30

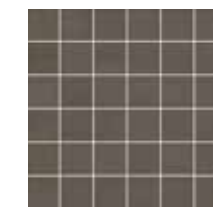

METALLICA DARK
MOSAICO 4,7X4,7
30X30



METALLICA MIX
MOSAICO 4,7X4,7
30X30



METALLICA WHITE
CHEVRON 3
30X30



METALLICA SILVER
CHEVRON 3
30X30



METALLICA TITAN
CHEVRON 3
30X30



METALLICA OXYD
CHEVRON 3
30X30



METALLICA DARK
CHEVRON 3
30X30



METALLICA MIX
CHEVRON 3
30X30



METALLICA WHITE
MOSAICO LOSANGO
23,6X28



METALLICA SILVER
MOSAICO LOSANGO
23,6X28



METALLICA TITAN
MOSAICO LOSANGO
23,6X28



METALLICA OXYD
MOSAICO LOSANGO
23,6X28





METALLICA DARK
MOSAICO LOSANGO
23,6X28



METALLICA MIX
MOSAICO LOSANGO
23,6X28

GAME OF STONES

 **GLAZED PORCELAIN TILES** _GRÉS PORCELÂNICO VIDRADO _GRÈS CÉRAMÉ ÉMAILLÉ
 **FEINSTEINZEUG GLASIERT** _GRÉS PORCELÂNICO
 EN 14411:2016 **GROUP** _GRUPO _GROUPE _GRUPPE **Bl**

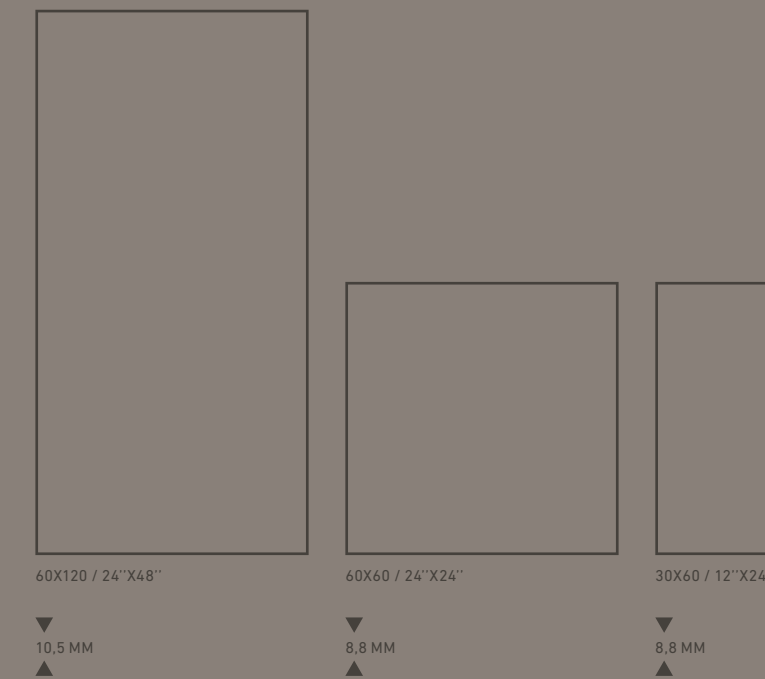

USAGE _USO

WALL, FLOOR, INTERIOR, COMMERCIAL, RESIDENTIAL

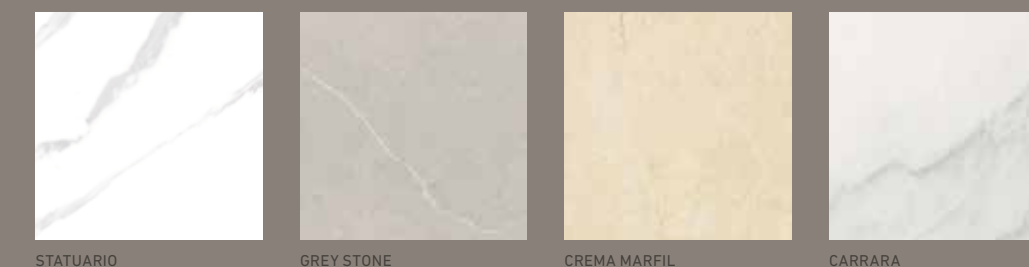

CARRARA 60X60



STATUARIO 60X60 R
STATUARIO 30X90 R



GREYSTONE 60X60

GAME OF STONES

 GLAZED PORCELAIN TILES _GRÉS PORCELÂNICO VIDRADO _GRÈS CÉRAME ÉMAILLÉ
 FEINSTEINZEUG GLASIERT _GRÉS PORCELÂNICO
 EN 14411:2016 GROUP _GRUPO _GROUPE _GRUPPE Bla



CREMA MARFIL 60X60



STATUARIO
GP 0745



GREYSTONE
GP 0746



CREMA MARFIL
GP 0382



CARRARA
GP 0384

SURFACE _SUPERFÍCIE

GLOSSY

FEATURES _ATRIBUTOS



FINISH _ACABAMENTO

NATURAL (NAT)
RECTIFIED (R)

SIZES _FORMATOS

60X120 R
60X60 R
60X60 NAT
30X60 R



STATUARIO LINES 30X90 R
STATUARIO 60X60 R



GREYSTONE 30X90 R
GREYSTONE LINES 30X90 R

GAME OF STONES

 **WHITE BODY WALL TILES** _REVESTIMENTOS EM PASTA BRANCA _CARREAUX DE MUR EN PATE BLANCHE
WEISSEN TON WANDFLIESEN _REVESTIMIENTOS EN PASTA BLANCA
EN 14411:2016 GROUP _GRUPO _GROUPE _GRUPPE BIII



STATUARIO
GM 0745



GREYSTONE
GM 0746



STATUARIO LINES
GM 0767



GREYSTONE LINES
GM 0768



STATUARIO SQUARES
GM 0763



GREYSTONE SQUARES
GM 0764



STATUARIO
MOSAICO ENTRELAÇADO
33X35



STATUARIO
MOSAICO HEXAGONAL
26X31,5



STATUARIO
MOSAICO 4,7X4,7
30X30



GREYSTONE
MOSAICO ENTRELAÇADO
33X35



GREYSTONE
MOSAICO HEXAGONAL
26X31,5

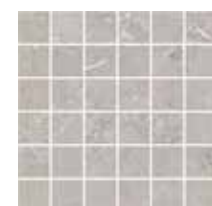

GREYSTONE
MOSAICO 4,7X4,7
30X30

GAME OF STONES

 **WHITE BODY WALL TILES** _REVESTIMENTOS EM PASTA BRANCA _CARREAUX DE MUR EN PATE BLANCHE
WEISSEN TON WANDFLIESEN _REVESTIMIENTOS EN PASTA BLANCA
EN 14411:2016 GROUP _GRUPO _GROUPE _GRUPPE BIII



CREMA MARFIL
GM 0382



CARRARA
GM 0384



CREMA MARFIL LINES
GM 0765



CARRARA LINES
GM 0766



CREMA MARFIL SQUARES
GM 0761



CARRARA SQUARES
GM 0762



CREMA MARFIL
MOSAICO ENTRELAÇADO
33X35



CREMA MARFIL
MOSAICO HEXAGONAL
26X31,5



CREMA MARFIL
MOSAICO 4,7X4,7
30X30



CARRARA
MOSAICO ENTRELAÇADO
33X35



CARRARA
MOSAICO HEXAGONAL
26X31,5



CARRARA
MOSAICO 4,7X4,7
30X30

SURFACE _SUPERFÍCIE	FINISH _ACABAMENTO	SIZES _FORMATOS THICKNESS _ESPESSURA	
GLOSSY	NATURAL (NAT)	30X90 R	10,5 MM
	RECTIFIED (R)	30X90 NAT	
	RECTIFIED (R)	30X60 R	9,5 MM
		30X60 NAT	

NEO

 **WHITE BODY WALL TILES** _REVESTIMENTOS EM PASTA BRANCA _CARREAUX DE MUR EN PATE BLANCHE
WEISSEN TON WANDFLIESEN _REVESTIMIENTOS EN PASTA BLANCA
EN 14411:2016 GROUP _GRUPO _GROUPE _GRUPPE BIII



NEO LINES MIX BEGE 30X90

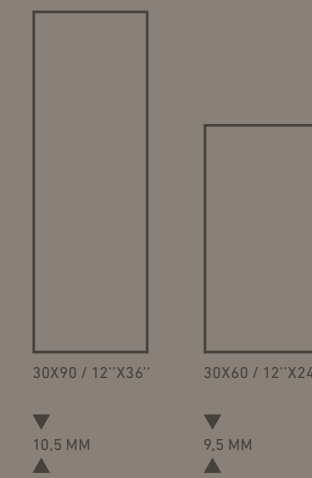

USAGE _USO

INTERIOR, COMMERCIAL, RESIDENTIAL





NEO LINES MIX GRUN BLAU 30X60
NEO POWDER 30X90
NEO BLUE 30X90
OAK WHITE 20X120



NEO GREEN 30X90
OAK DARK 20X120

NEO

WHITE BODY WALL TILES _REVESTIMENTOS EM PASTA BRANCA _CARREAUX DE MUR EN PATE BLANCHE
WEISSEN TON WANDFLIESEN _REVESTIMIENTOS EN PASTA BLANCA
EN 14411:2016 GROUP _GRUPO _GROUPE _GRUPPE BIII

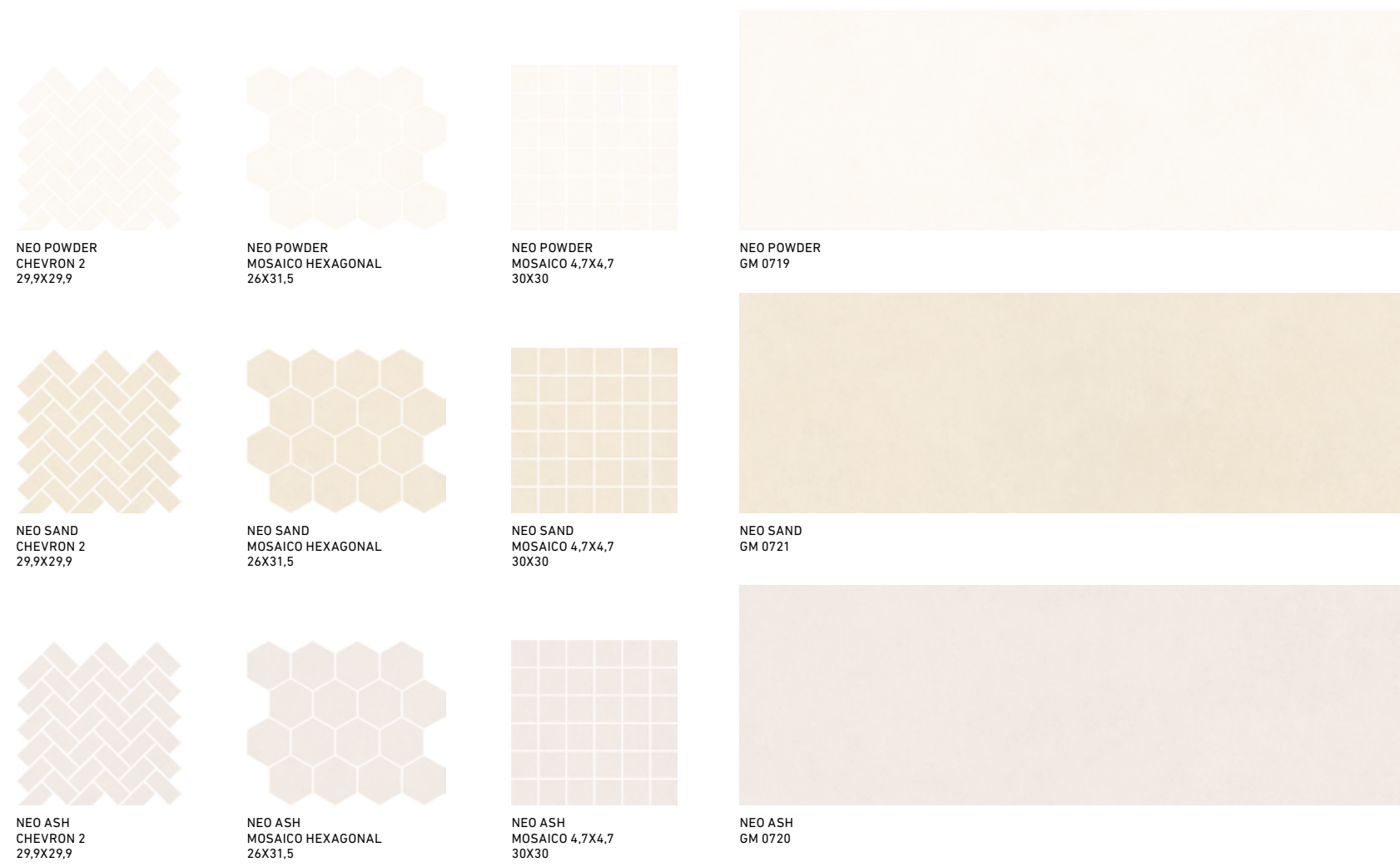

NEO POWDER
CHEVRON 2
29,9X29,9

NEO POWDER
MOSAICO HEXAGONAL
26X31,5

NEO POWDER
MOSAICO 4,7X4,7
30X30

NEO POWDER
GM 0719

NEO SAND
CHEVRON 2
29,9X29,9

NEO SAND
MOSAICO HEXAGONAL
26X31,5

NEO SAND
MOSAICO 4,7X4,7
30X30

NEO SAND
GM 0721

NEO ASH
CHEVRON 2
29,9X29,9

NEO ASH
MOSAICO HEXAGONAL
26X31,5

NEO ASH
MOSAICO 4,7X4,7
30X30

NEO ASH
GM 0720

RECOMMENDED CERAMIC TILES COMBINATION _COMBINAÇÃO CERÂMICA RECOMENDADA



NEO POWDER

NEO SAND

NEO ASH

OAK WHITE
GP 0622

RUSTY ASH
GP 0536

OAK CREAM
GP 0517

RUSTY SAND
GP 0535

OAK TORTORA
GP 0518

RUSTY ASH
GP 0536

NEO

WHITE BODY WALL TILES _REVESTIMENTOS EM PASTA BRANCA _CARREAUX DE MUR EN PATE BLANCHE
WEISSEN TON WANDFLIESEN _REVESTIMIENTOS EN PASTA BLANCA
EN 14411:2016 GROUP _GRUPO _GROUPE _GRUPPE BIII

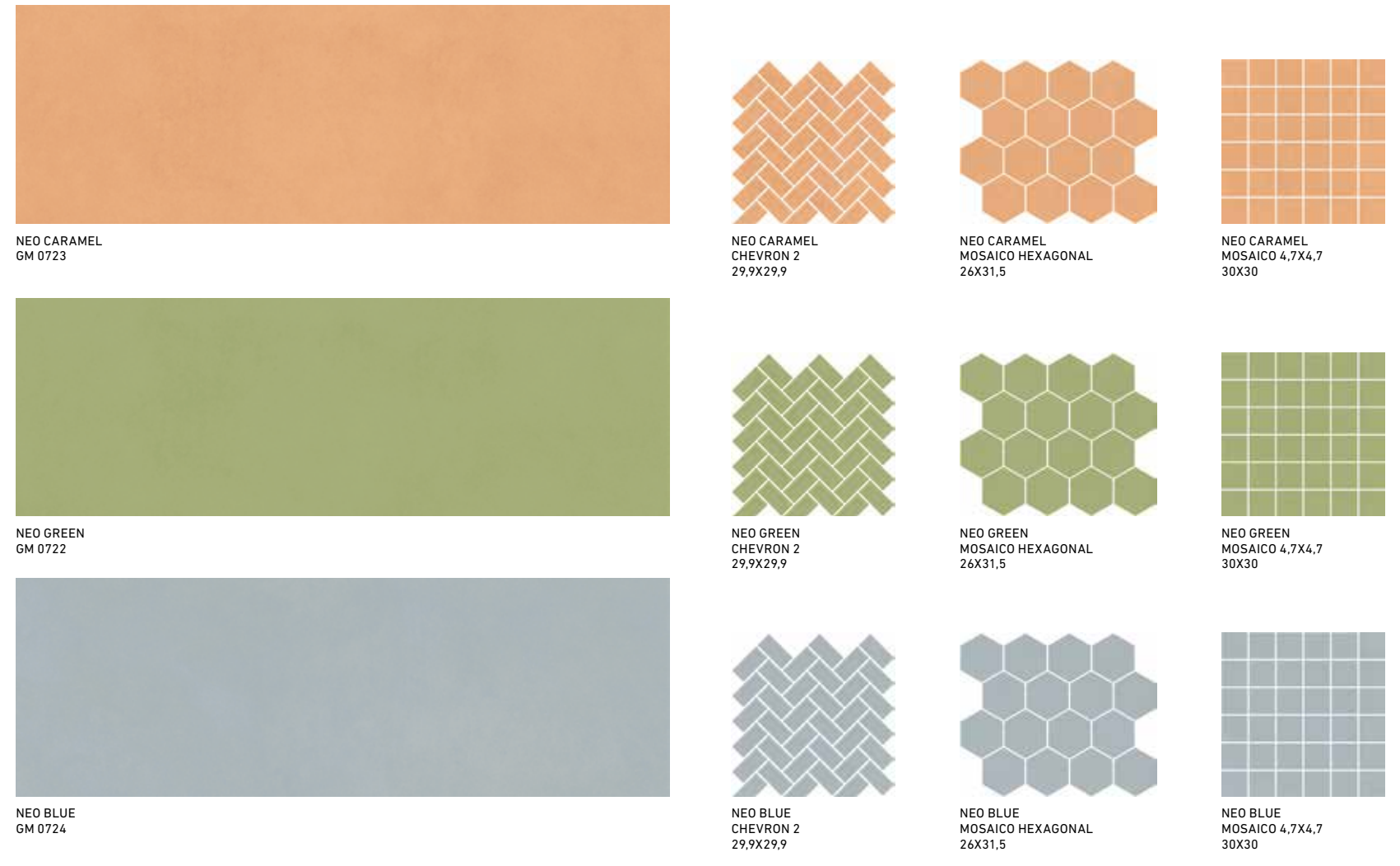

NEO CARAMEL
GM 0723

NEO CARAMEL
CHEVRON 2
29,9X29,9

NEO CARAMEL
MOSAICO HEXAGONAL
26X31,5

NEO CARAMEL
MOSAICO 4,7X4,7
30X30

NEO GREEN
GM 0722

NEO GREEN
CHEVRON 2
29,9X29,9

NEO GREEN
MOSAICO HEXAGONAL
26X31,5

NEO GREEN
MOSAICO 4,7X4,7
30X30

NEO BLUE
GM 0724

NEO BLUE
CHEVRON 2
29,9X29,9

NEO BLUE
MOSAICO HEXAGONAL
26X31,5

NEO BLUE
MOSAICO 4,7X4,7
30X30

RECOMMENDED CERAMIC TILES COMBINATION _COMBINAÇÃO CERÂMICA RECOMENDADA

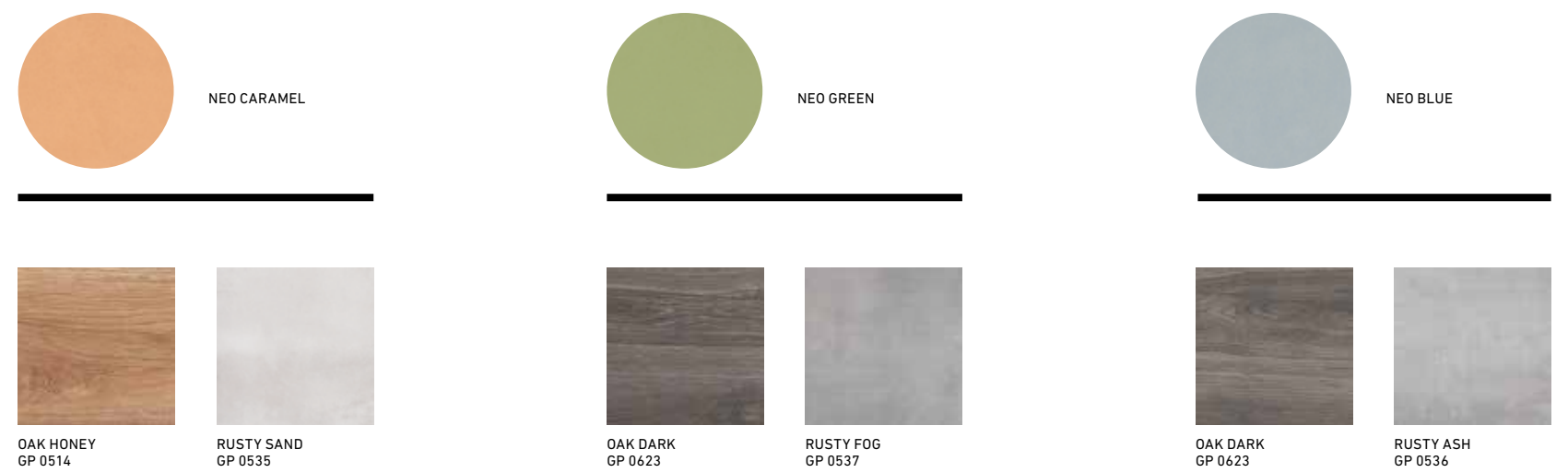

NEO CARAMEL

NEO GREEN

NEO BLUE

OAK HONEY
GP 0514

RUSTY SAND
GP 0535

OAK DARK
GP 0623

RUSTY FOG
GP 0537

OAK DARK
GP 0623

RUSTY ASH
GP 0536

SURFACE _SUPERFÍCIE	FINISH _ACABAMENTO	SIZES _FORMATOS THICKNESS _ESPESSURA	
MATT	NATURAL (NAT)	30X90 R	10,5 MM
		30X90 NAT	
	RECTIFIED (R)	30X60 R	9,5 MM
		30X60 NAT	



NEO

 **WHITE BODY WALL TILES** _REVESTIMENTOS EM PASTA BRANCA _CARREAUX DE MUR EN PATE BLANCHE
WEISSEN TON WANDFLIESEN _REVESTIMIENTOS EN PASTA BLANCA
EN 14411:2016 GROUP _GRUPO _GROUPE _GRUPPE BIII



NEO LINES MIX CARAMEL
GM 0725



NEO LINES MIX GRUN BLAU
GM 0726



NEO LINES MIX BEGE
GM 0727



NEO LINES MIX GREY
GM 0728



MOSAICO ESCAMAS*
30X32,3

*PECAS EMBALADAS ALEATORIAMENTE POR CAIXA
TILES ARE PACKED RANDOMLY IN THE SAME BOX

SURFACE _SUPERFÍCIE	FINISH _ACABAMENTO	SIZES _FORMATOS THICKNESS _ESPESSURA	
MATT	NATURAL (NAT)	30X90 R	10,5 MM
		30X90 NAT	
	RECTIFIED (R)	30X60 R	9,5 MM
		30X60 NAT	

STEEL

 **WHITE BODY WALL TILES** _REVESTIMENTOS EM PASTA BRANCA _CARREAUX DE MUR EN PATE BLANCHE
WEISSEN TON WANDFLIESEN _REVESTIMIENTOS EN PASTA BLANCA
EN 14411:2016 GROUP _GRUPO _GROUPE _GRUPPE BIII



STEEL WHITE
GM 0769

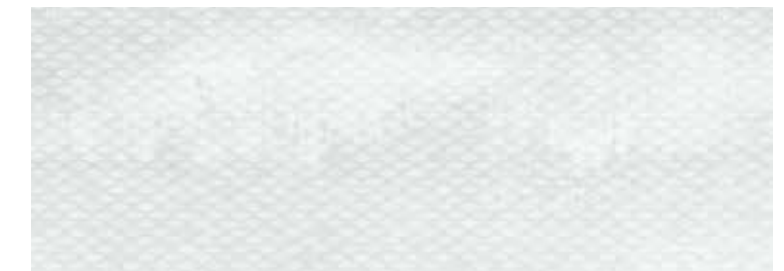

STEEL COMB WHITE
GM 0785



STEEL FOG
GM 0770



STEEL COMB FOG
GM 0786



STEEL SMOKE
GM 0771



STEEL COMB SMOKE
GM 0787



STEEL WHITE 25X70 R
STEEL FOG 25X70 R
RUSTY DECOR 60X60

SURFACE _SUPERFÍCIE

MATT

FINISH _ACABAMENTO

NATURAL (NAT)
RECTIFIED (R)

SIZES _FORMATOS
THICKNESS _ESPESSURA

25X70 R
25X70 NAT
10 MM

PLASTER

 **WHITE BODY WALL TILES** _REVESTIMENTOS EM PASTA BRANCA _CARREAUX DE MUR EN PATE BLANCHE
WEISSEN TON WANDFLIESEN _REVESTIMIENTOS EN PASTA BLANCA
EN 14411:2016 GROUP _GRUPO _GROUPE _GRUPPE BIII

SURFACE _SUPERFÍCIE

MATT

FINISH _ACABAMENTO

NATURAL (NAT)
RECTIFIED (R)

SIZES _FORMATOS
THICKNESS _ESPESSURA

25X70 R 10 MM
25X70 NAT



PLASTER WHITE
GM 0772



PLASTER WAVE WHITE
GM 0774



PLASTER GREY
GM 0773



PLASTER WAVE GREY
GM 0775



PLASTER WAVE GREY 25X70 R

BROOKLYN

 **WHITE BODY WALL TILES** _REVESTIMENTOS EM PASTA BRANCA _CARREAUX DE MUR EN PATE BLANCHE
WEISSEN TON WANDFLIESEN _REVESTIMIENTOS EN PASTA BLANCA
EN 14411:2016 GROUP _GRUPO _GROUPE _GRUPPE BIII

SURFACE _SUPERFÍCIE

MATT

FINISH _ACABAMENTO

NATURAL (NAT)
RECTIFIED (R)

SIZES _FORMATOS
THICKNESS _ESPESSURA

30X60 R 9,5 MM
30X60 NAT



BROOKLYN WHITE
GM 0707



BROOKLYN ASH
GM 0708



BROOKLYN FOG
GM 0709



BROOKLYN SMOKE
GM 0710



BROOKLYN LIGHT
GM 0711

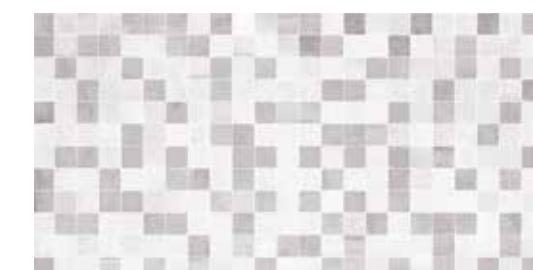

BROOKLYN DARK
GM 0712



BROOKLYN DECOR
GM 0713



BROOKLYN FOG 30X60
HERITAGE COLOR 4

OXYDA

 **WHITE BODY WALL TILES** _REVESTIMENTOS EM PASTA BRANCA _CARREAUX DE MUR EN PATE BLANCHE
WEISSEN TON WANDFLIESEN _REVESTIMIENTOS EN PASTA BLANCA
EN 14411:2016 GROUP _GRUPO _GROUPE _GRUPPE BIII

SURFACE _SUPERFÍCIE

GLOSSY

FINISH _ACABAMENTO

NATURAL (NAT)
RECTIFIED (R)

SIZES _FORMATOS
THICKNESS _ESPESSURA

30X60 R 9,5 MM
30X60 NAT



OXYDA WHITE
GM 0731



OXYDA WHITE SQUARES
GM 0735



OXYDA OFFWHITE
GM 0732



OXYDA OFFWHITE SQUARES
GM 0736



OXYDA RUST
GM 0733



OXYDA RUST SQUARES
GM 0737



OXYDA TITAN
GM 0734



OXYDA TITAN SQUARES
GM 0738



OXYDA WHITE 30X60 R

BURLINGTON

 **WHITE BODY WALL TILES** _REVESTIMENTOS EM PASTA BRANCA _CARREAUX DE MUR EN PATE BLANCHE
WEISSEN TON WANDFLIESEN _REVESTIMIENTOS EN PASTA BLANCA
EN 14411:2016 GROUP _GRUPO _GROUPE _GRUPPE BIII



BURLINGTON FOG
GM 0739



BURLINGTON FOG SQUARES
GM 0742



BURLINGTON CREAM
GM 0740



BURLINGTON CREAM SQUARES
GM 0743



BURLINGTON TAUPE
GM 0741



BURLINGTON TAUPE SQUARES
GM 0744

SURFACE _SUPERFÍCIE

MATT

FINISH _ACABAMENTO

NATURAL (NAT)
RECTIFIED (R)

SIZES _FORMATOS

THICKNESS _ESPESSURA

30X60 R 9,5 MM
30X60 NAT



BURLINGTON TAUPE 30X60
BURLINGTON SQUARES TAUPE 30X60

LUXOR

 **WHITE BODY WALL TILES** _REVESTIMENTOS EM PASTA BRANCA _CARREAUX DE MUR EN PATE BLANCHE
WEISSEN TON WANDFLIESEN _REVESTIMIENTOS EN PASTA BLANCA
EN 14411:2016 GROUP _GRUPO _GROUPE _GRUPPE BIII

SURFACE _SUPERFÍCIE

GLOSSY

FINISH _ACABAMENTO

NATURAL (NAT)

SIZES _FORMATOS

THICKNESS _ESPESSURA

30X60 NAT 9,5 MM

33X33 NAT 7,8 MM



LUXOR GREY
GM 0511



LUXOR GREY DECOR
GM 0513

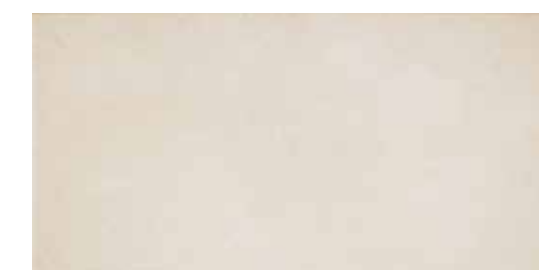

LUXOR BEGE
GM 0512



LUXOR BEGE DECOR
GM 0519



LUXOR BEGE 30X60
LUXOR BEGE DECOR 30X60
LUXOR BEGE 33X33

BRANCOS

 **WHITE BODY WALL TILES** _REVESTIMENTOS EM PASTA BRANCA _CARREAUX DE MUR EN PATE BLANCHE
WEISSEN TON WANDFLIESEN _REVESTIMIENTOS EN PASTA BLANCA
EN 14411:2016 GROUP _GRUPO _GROUPE _GRUPPE BIII

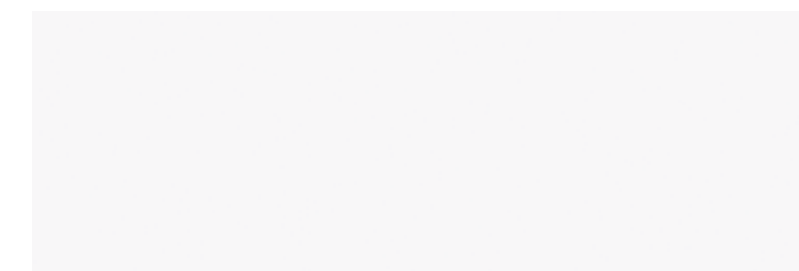

BRANCO BRILHO
GM 0001

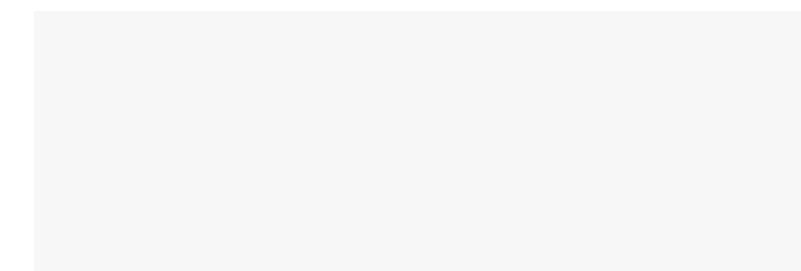

BRANCO MATE
GM 0002

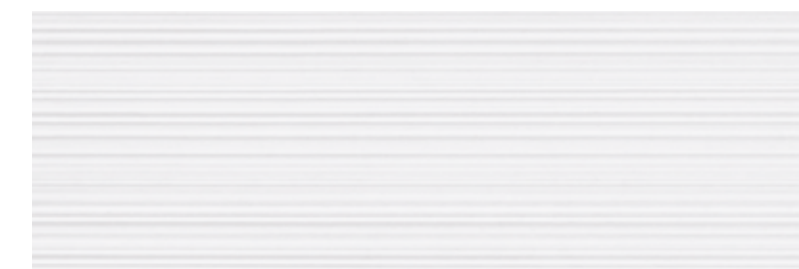

BRANCO BRILHO LINES
GM 0783

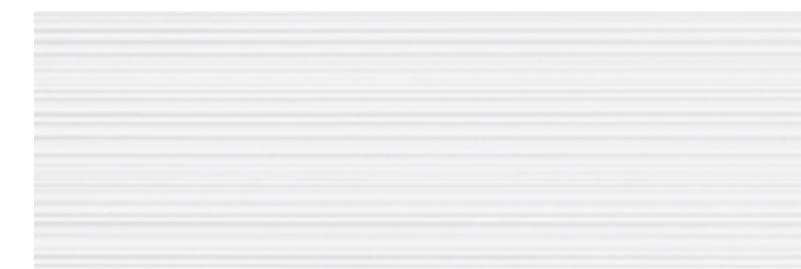

BRANCO MATES LINES
GM 0784

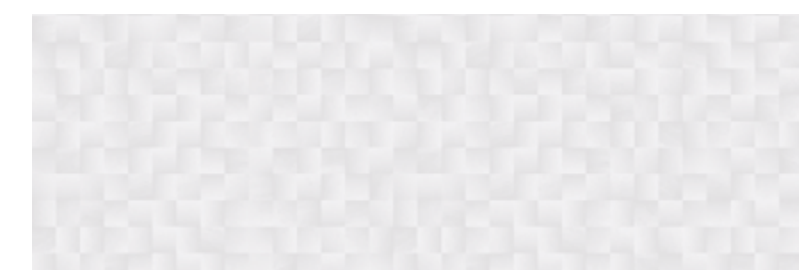

BRANCO BRILHO SQUARES
GM 0781



BRANCO MATE SQUARES
GM 0782



BRANCO BRILHO 30X60

SURFACE _SUPERFÍCIE	FINISH _ACABAMENTO	SIZES _FORMATOS	
		THICKNESS _ESPESSURA	
MATT GLOSSY	NATURAL (NAT)	30X90 R	10,5 MM
	RECTIFIED (R)	30X90 NAT	
		30X60 R	9,5 MM
		30X60 NAT	
		20X50 NAT	9 MM

PLAYTTILE
20X50



+ +
+

new tastes
NEW COLORS











*color
the
way*

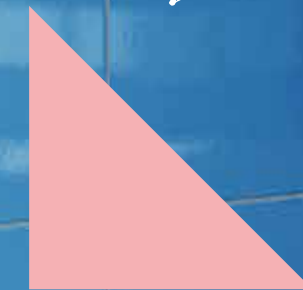

PLAYTILE







PLAYTILE AMARELO BRILHO
GM 0169



PLAYTILE AZUL CLARO BRILHO
GM 0170



PLAYTILE AZUL ESCURO BRILHO
GM 0171



PLAYTILE LARANJA BRILHO
GM 0172



PLAYTILE VERDE BRILHO
GM 0173



PLAYTILE ROSA BRILHO
GM 0174



PLAYTILE VIOLETA BRILHO
GM 0280



PLAYTILE VERMELHO BRILHO
GM 0176



GA 1470



GA 1471



GA 1472

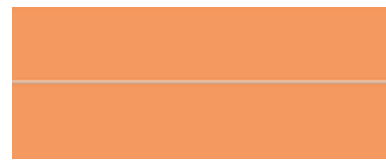

GA 1473



GA 1474

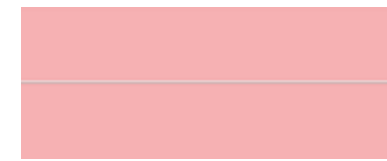

GA 1475



GA 1792



GA 1477

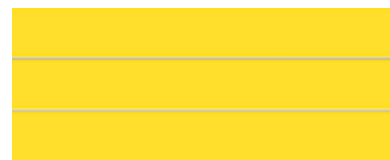

GA 1487



GA 1488



GA 1489

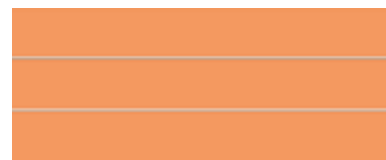

GA 1490

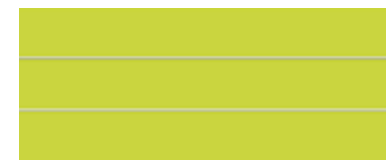

GA 1491

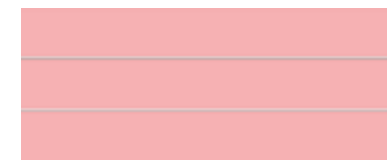

GA 1492



GA 1793



GA 1494

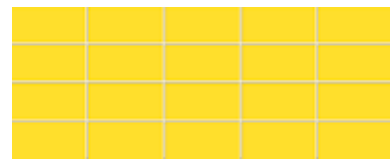

GA 1504

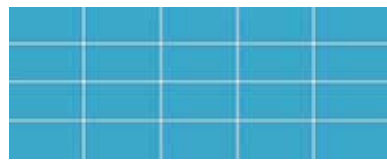

GA 1505

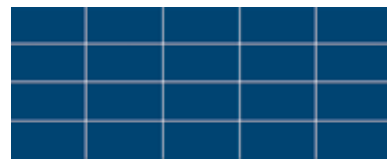

GA 1506

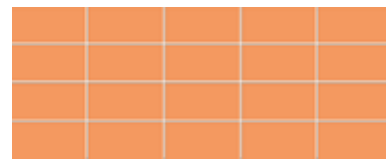

GA 1507

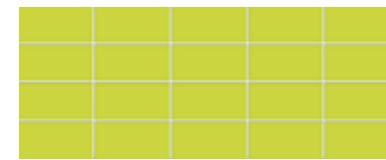

GA 1508

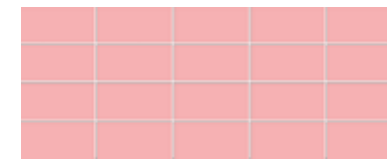

GA 1509

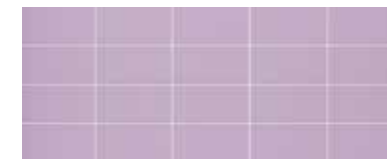

GA 1794



GA 1511

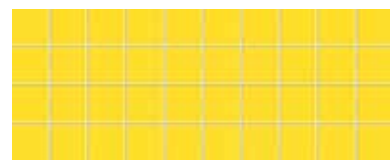

GA 1521

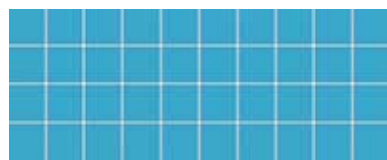

GA 1522

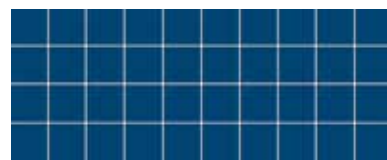

GA 1523

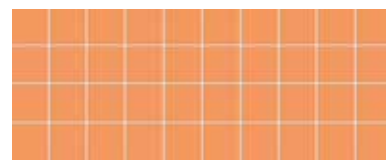

GA 1524

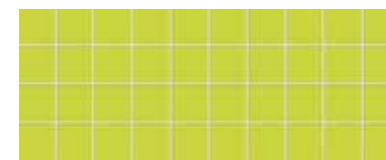

GA 1525

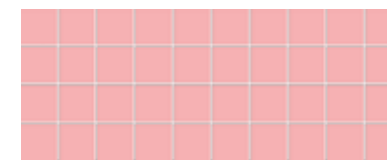

GA 1526

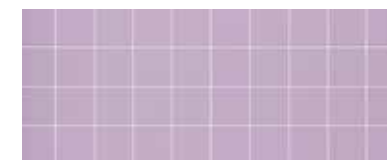

GA 1795



GA 1528



GA 2224



GA 2225



GA 2226



GA 2227



GA 2228



GA 2229



GA 2237



GA 2231



GA 1402



GA 1403



GA 1404



GA 1405



GA 1406



GA 1407



GA 1786



GA 1409



GA 1453



GA 1454



GA 1455



GA 1456



GA 1457



GA 1458



GA 1788



GA 1460



GA 1777
2X50



GA 1778
2X50



GA 1779
2X50



GA 1780
2X50



GA 1781
2X50















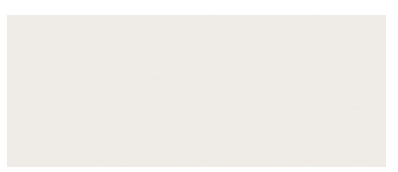

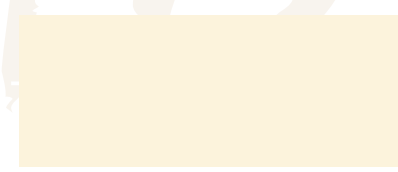



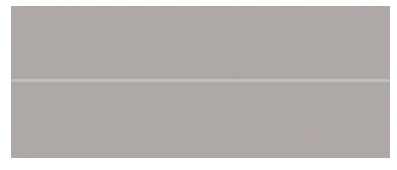
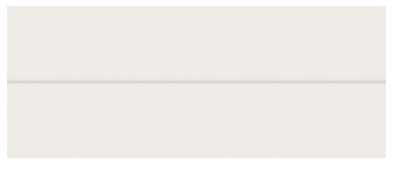
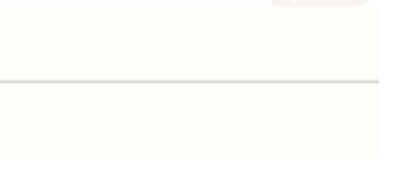

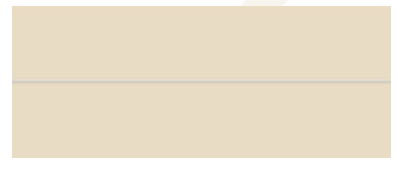
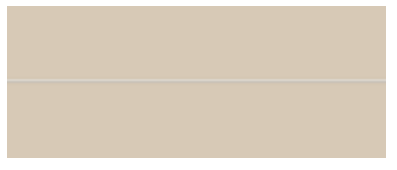



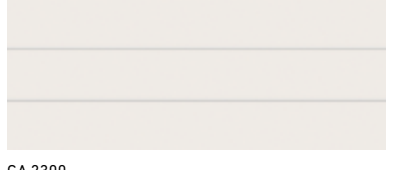

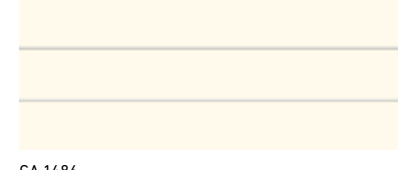
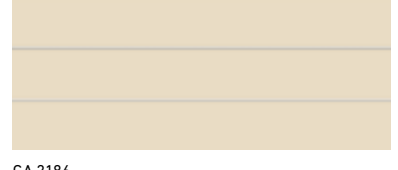
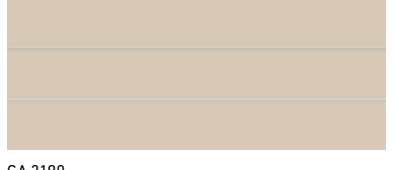

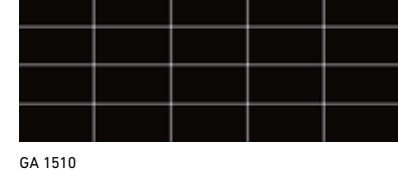
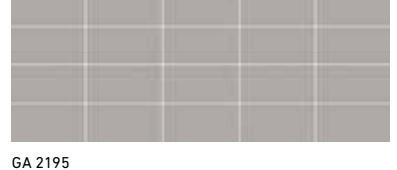
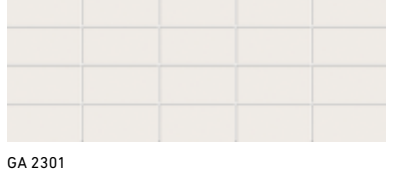
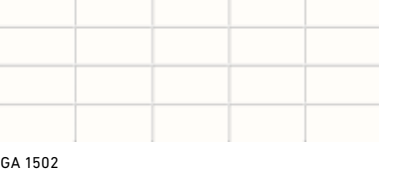
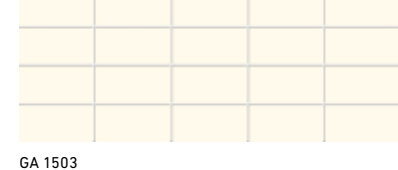
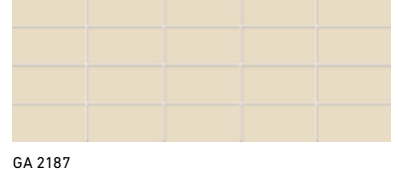
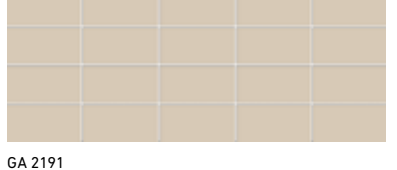
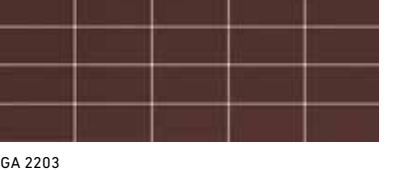

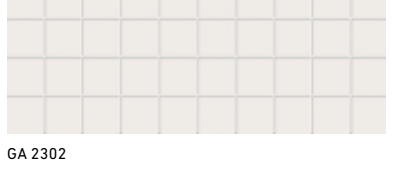
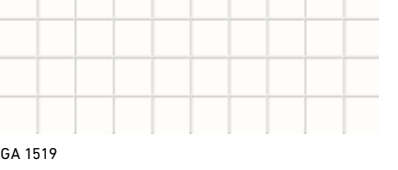
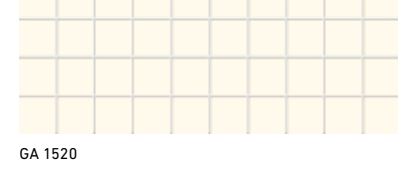
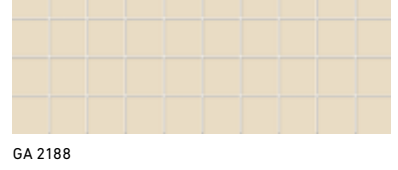
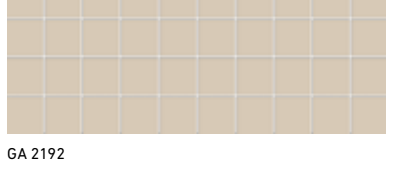



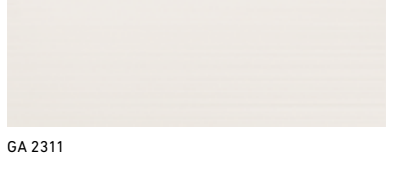

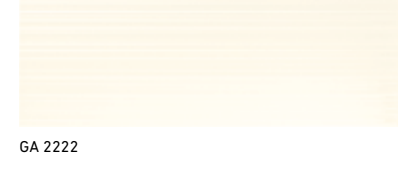





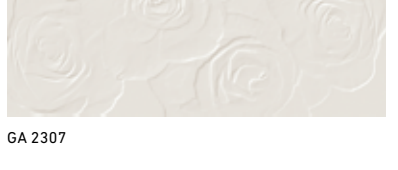







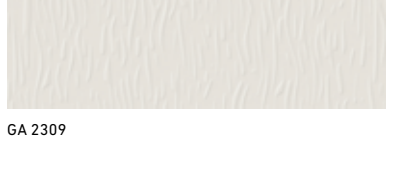



GA 1782
2X50



GA 1785
2X50



GA 1784
2X50

 PLAYTILE PRETO BRILHO GM 0175	 PLAYTILE CINZA BRILHO GM 0410	 PLAYTILE CINZA CLARO BRILHO GM 0633	 PLAYTILE BRANCO BRILHO GM 0001	 PLAYTILE OFF-WHITE BRILHO GM 0165	 PLAYTILE CREME BRILHO GM 0408	 PLAYTILE TERRA BRILHO GM 0409	 PLAYTILE CASTANHO BRILHO GM 0412
 GA 1476	 GA 2193	 GA 2299	 GA 1468	 GA 1469	 GA 2185	 GA 2189	 GA 2201
 GA 1493	 GA 2194	 GA 2300	 GA 1485	 GA 1486	 GA 2186	 GA 2190	 GA 2202
 GA 1510	 GA 2195	 GA 2301	 GA 1502	 GA 1503	 GA 2187	 GA 2191	 GA 2203
 GA 1527	 GA 2196	 GA 2302	 GA 1519	 GA 1520	 GA 2188	 GA 2192	 GA 2204
 GA 2230	 GA 2141	 GA 2311	 GA 2220	 GA 2222	 GA 2239	 GA 2240	 GA 2243
 GA 1408	 GA 2212	 GA 2307	 GA 1400	 GA 1401	 GA 2210	 GA 2211	 GA 2214
 GA 1459	 GA 2217	 GA 2309	 GA 1451	 GA 1452	 GA 2215	 GA 2216	 GA 2219
 GA 1783 2X50	 GA 2207 2X50	 GA 2313 2X50	 GA 1775 2X50	 GA 1776 2X50	 GA 2205 2X50	 GA 2206 2X50	 GA 2209 2X50

glossy

PLAYTILE BRILHO



PLAYTILE PRETO MATE
GM 0281



PLAYTILE CINZA MATE
GM 0181

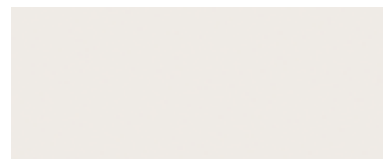

PLAYTILE CINZA CLARO MATE
GM 0634



PLAYTILE BRANCO MATE
GM 0002

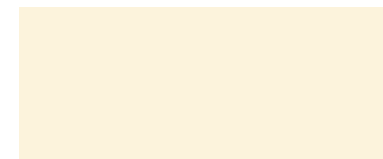

PLAYTILE OFF-WHITE MATE
GM 0166



PLAYTILE CREME MATE
GM 0179



PLAYTILE TERRA MATE
GM 0180



PLAYTILE CASTANHO MATE
GM 0183



GA 1796

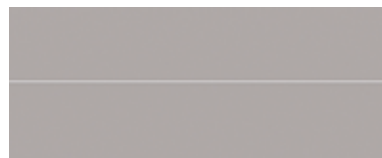

GA 1482

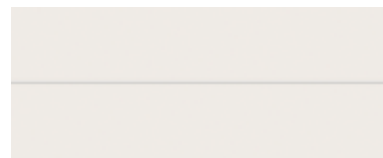

GA 2303

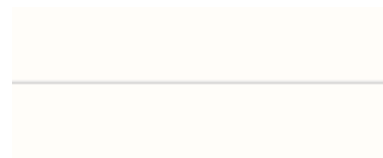

GA 1478

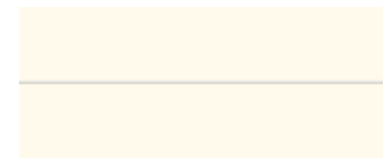

GA 1479

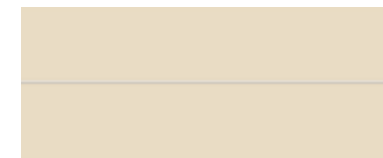

GA 1480



GA 1481

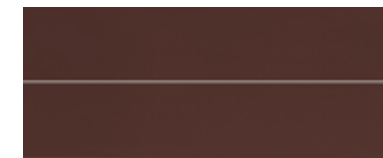

GA 1484



GA 1797

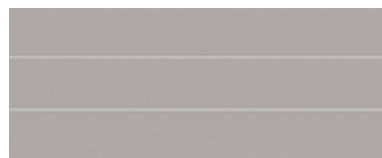

GA 1499

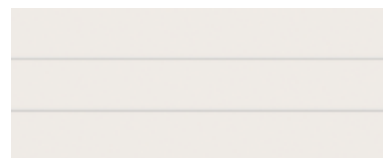

GA 2304



GA 1495

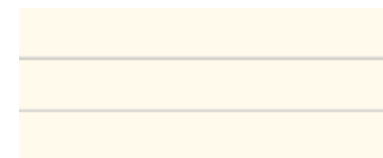

GA 1496

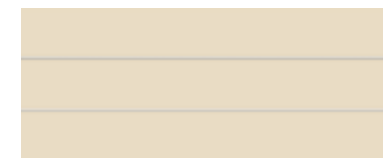

GA 1497

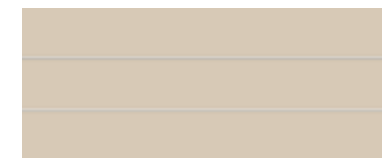

GA 1498

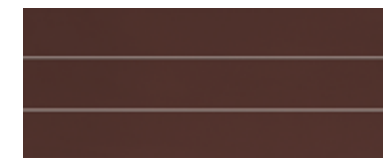

GA 1501

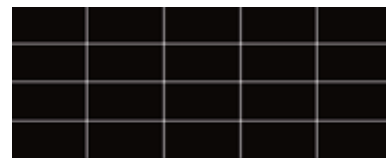

GA 1798

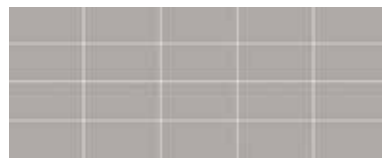

GA 1516

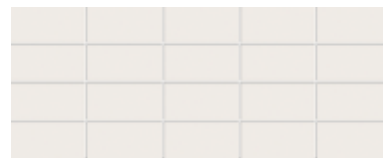

GA 2305

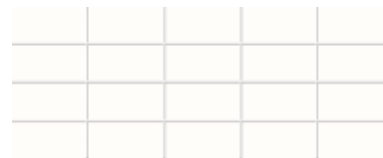

GA 1512

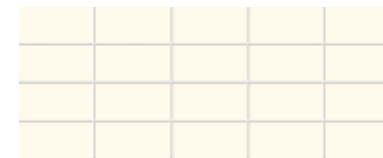

GA 1513

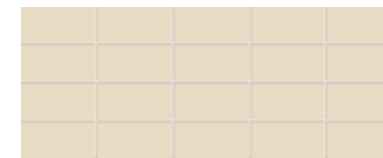

GA 1514

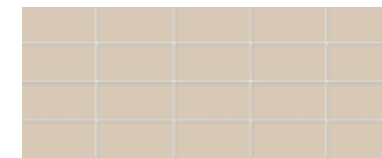

GA 1515

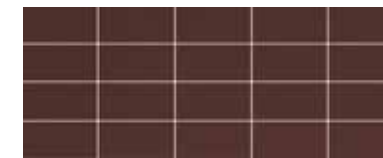

GA 1518

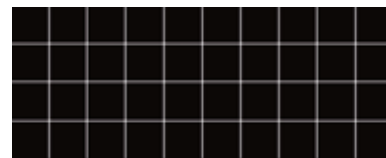

GA 1799

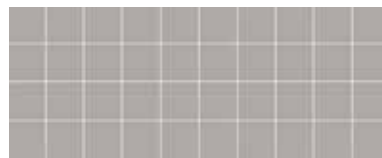

GA 1533

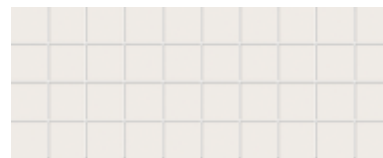

GA 2306



GA 1529

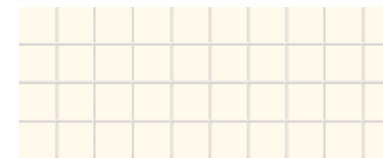

GA 1530

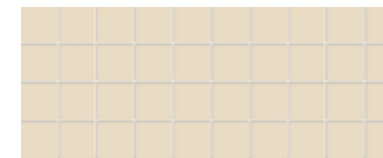

GA 1531

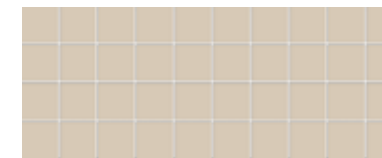

GA 1532

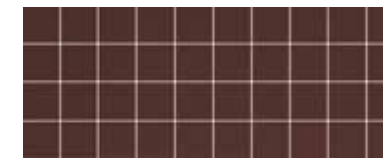

GA 1535



GA 2238



GA 2234

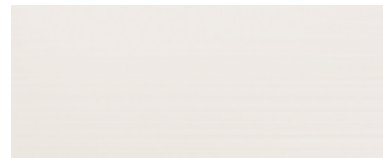

GA 2312

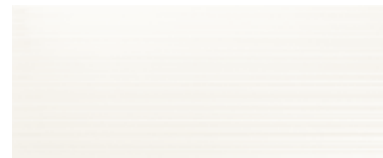

GA 2221

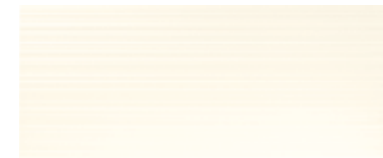

GA 2223



GA 2232



GA 2233



GA 2236



GA 1789



GA 1414



GA 2308



GA 1410



GA 1411



GA 1412



GA 1413



GA 1416



GA 1791



GA 1465



GA 210



GA 1461



GA 1462



GA 1463



GA 1464



GA 1467

mate



PLAYTILE DECOR BLUE
GM 0651

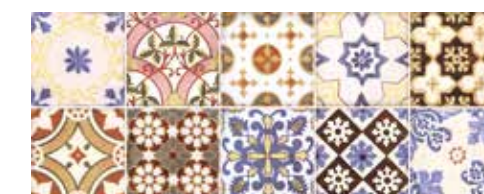

PLAYTILE DECOR COLOR
GM 0652

new
DECORS
20X50



PLAYTILE DECOR PATCHWORK
GM 0653

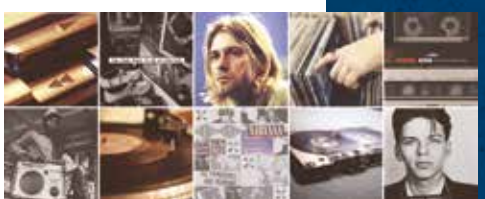
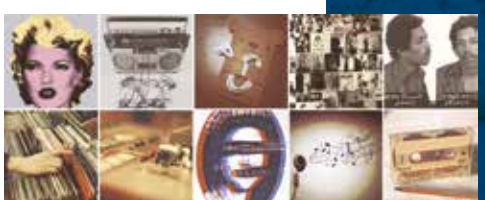

PLAYTILE DECOR MUSIC
GM 0635

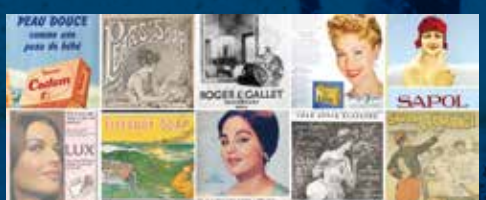

PLAYTILE DECOR SOAP
GM 0636



PLAYTILE DECOR ANGELS
GM 0637



PLAYTILE STRACCIATILE BLUE GREEN
GM 0776



PLAYTILE STRACCIATILE BORDEAUX
GM 0777



PLAYTILE STRACCIATILE MIMO
GM 0778



PLAYTILE KIDS
SOFT
GM 0779



PLAYTILE KIDS SOFT
GM 0780



PLAYTILE

MATCHING FLOOR

33X33 / 13"X13"

▼
7,8 MM
▲

FLOOR PRETO BRILHO
GR 0275
33X33

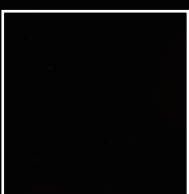

FLOOR BRANCO BRILHO
GR 0273
33X33



FLOOR AZUL BRILHO
GR 0274
33X33



FLOOR VERMELHO BRILHO
GR 0276
33X33



MATRIX BEGE
GP 0475
33X33



MATRIX NOZ
GP 0479
33X33



MATRIX PISTACHIO
GP 0477
33X33



MATRIX CINZA
GP 0476
33X33



MATRIX ESTANHO
GP 0478
33X33





CODE AZUL 20X50
CODE BRANCO 20X50



CODE BRANCO 20X50
CODE VIOLETA 20X50



CODE BEGE 20X50



CODE BRANCO
GM 0385
20X50



CODE BEGE
GM 0386
20X50



CODE CINZA
GM 0387
20X50



CODE AZUL
GM 0388
20X50

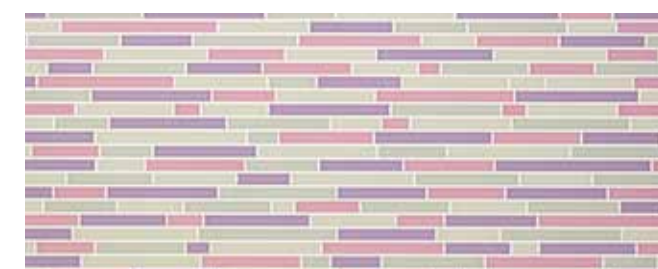

CODE VIOLETA
GM 0389
20X50

EMBALAGENS E PESOS • PACKING LIST

GRÉS PORCELÂNICO • GLAZED PORCELAIN								
	ACABAMENTO FINISH	FORMATO SIZE	PEÇAS CAIXA PIECES BOX	PESO CAIXA WEIGHT BOX	M2 CAIXA SQ.MT.BOX	CAIXAS PALETE BOX PALLET	PESO PALETE WEIGHT PALLET	M2 PALETE SQ.MT.PALLET
GP	NAT	60x60 / 24"x24"	4	± 26.5 Kg	1,47	32	± 848 Kg	47,04
GP	NAT (GAME OF STONES)	60x60 / 24"x24"	3	± 26.5 Kg	1,10	32	± 848 Kg	35,20
GP	NAT	50x50 / 20"x20"	4	± 22 Kg	1,02	36	± 792 Kg	36,72
GP	NAT	22,5x90 / 9"x36"	6	± 23 Kg	1,22	48	± 1.104 Kg	58,56
GP	NAT	30x60 / 12"x24"	7	± 24 Kg	1,27	40	± 960 Kg	50,80
GP	NAT (RORIZ)	30x60 / 12"x24"	7	± 24 Kg	1,27	60	± 1.440 Kg	76,20
GP	NAT	40x40 / 16"x16"	9	± 25 Kg	1,46	48	± 1.200 Kg	70,08
GP	NAT	33x47 / 13"x18"	7	± 21 Kg	1,10	44	± 924 Kg	48,40
GP	NAT	33x33 / 13"x13"	10	± 17 Kg	1,15	68	± 1.156 Kg	78,20
GP	NAT	15x75 / 6"x30"	10	± 21.5 Kg	1,13	60	± 1.290 Kg	67,80
GP	NAT	15x60 / 6"x24"	12	± 23.5 Kg	1,08	40	± 940 Kg	43,20

Indica-se a utilização de junta mínima de 3 mm para produtos NAT. • For NAT products, use a minimum 3 mm joint.

GRÉS PORCELÂNICO RETIFICADO / SEMI-POLIDO • GLAZED PORCELAIN RECTIFIED / SEMI-POLISHED								
GPR	R / SP	90x90 R / 36"x36"	2	± 38 Kg	1,61	36	± 1.368 Kg	57,96
GPR	R / SP	60x120 R / 24"x48"	2	± 35 Kg	1,43	29	± 1.015 Kg	41,47
GPR	R / SP	45x90 R / 18"x36"	4	± 35 Kg	1,61	42	± 1.470 Kg	67,62
GPR	R / SP	60x60 R / 24"x24"	4	± 26.5 Kg	1,43	32	± 848 Kg	45,76
GPR	R / SP	60x60 R / 24"x24"	3	± 26.5 Kg	1,07	40	± 1.060 Kg	42,80
GPR	R / SP	20x120 R / 8"x48"	6	± 35 Kg	1,42	36	± 1.260 Kg	51,12
GPR	R / SP	22,5 x90 R / 9"x36"	6	± 23 Kg	1,17	36	± 828 Kg	42,12
GPR	R / SP	30x60 R / 12"x24"	7	± 24 Kg	1,25	40	± 960 Kg	50
GPR	R / SP	15x75 R / 6"x30"	10	± 21.5 Kg	1,15	60	± 1.290 Kg	69

Indica-se a utilização de junta de 2 mm para produtos R/SP. • For R/SP use a 2mm joint.

REVESTIMENTO EM PASTA BRANCA • WHITE BODY WALL TILES								
GM	NAT	20x50 / 8"x20"	12	± 18 Kg	1,2	48	± 864 Kg	57,60
GM	NAT	30x60 / 12"x24"	7	± 21 Kg	1,26	32	± 672 Kg	40,32
GM	NAT	25x70 / 10"x28"	6	± 19 Kg	1,05	48	± 912 Kg	50,40
GM	NAT	30x90 / 12"x36"	4	± 21 Kg	1,1	42	± 882 Kg	46,20

Indica-se a utilização de junta mínima de 3 mm para produtos NAT. • For NAT products, use a minimum 3 mm joint.

REVESTIMENTO EM PASTA BRANCA RETIFICADA • RECTIFIED WHITE BODY WALL TILES								
GMR	R	30x60 R / 12"x24"	7	± 21 Kg	1,23	32	± 672 Kg	39,36
GMR	R	25x70 R / 10"x28"	6	± 19 Kg	0,97	48	± 912 Kg	46,56
GMR	R	30x90 R / 12"x36"	4	± 21 Kg	1,05	42	± 882 Kg	44,10

Indica-se a utilização de junta de 2 mm para produtos R. • For R use a 2mm joint.

Os valores das dimensões e pesos são aproximados. Size and weight values are approximate.
 O peso de uma paleta é aproximadamente 20 kg. The weight of one pallet is approximate 20 kg.
 O peso da paleta não está incluído nos valores indicados nos quadros. The pallet weight is not include in the values mentioned in the table.

FORMATOS DISPONÍVEIS • AVAILABLE FORMATS_(NOMINAL SIZES_FORMATOS NOMINAIS)

PORCELAIN

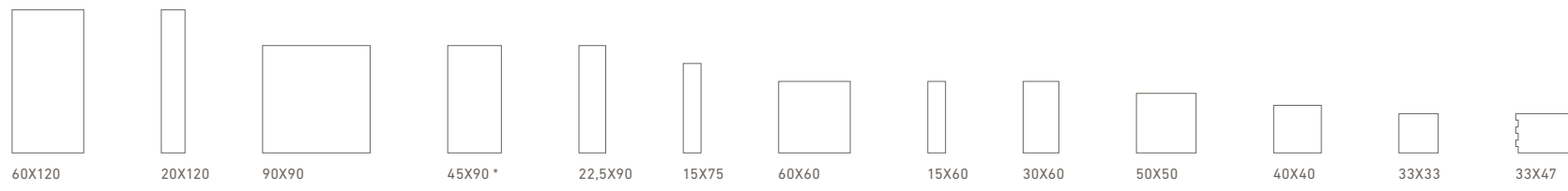

ANARCHIC BEDROCK BETON GAME OF STONES LIVING METALLICA SASSI TERRAZZO	DECK OAK PAINTWOOD SHABBY VERMONT	ANARCHIC BEDROCK BETON LIVING METALLICA SASSI TERRAZZO	ANARCHIC BEDROCK BETON LIVING METALLICA SASSI TERRAZZO	OAK SHABBY VERMONT	DECK MAPLE OAK PAINTWOOD	ANARCHIC BEDROCK BETON CEMENTONE GAME OF STONES LIVING MATRIX METALLICA MIX&MATCH MOLEANOS RUSTY SANDSTONE SASSI TERRAZZO URBAN CONCRETE	DECK VINTAGE	ANARCHIC ARDÓSIA BEDROCK BETON CEMENTONE DECK FORM GAME OF STONES LIVING MATRIX METALLICA MIX&MATCH MOLEANOS RORIZ RUSTY SANDSTONE SASSI SLATE TERRAZZO URBAN CONCRETE	AVANT	BETON HERITAGE	ARDÓSIA COTTO FLOOR LUXOR MATRIX RORIZ	BRICK LINEA
--	---	--	--	--------------------------	-----------------------------------	--	-----------------	---	-------	-------------------	---	----------------

WALL



BRANCOS PLASTER STEEL	BRANCOS BROOKLYN BURLINGTON GAME OF STONES LUXOR METALLICA MIX&MATCH NEO OXYDA	BRANCOS GAME OF STONES METALLICA NEO	BRANCOS CODE PLAYTILE
-----------------------------	--	---	-----------------------------

* Sob encomenda / By special order

RESISTÊNCIA À ABRASÃO • ABRASION RESISTANCE • RÉSISTANCE À LÁBRASION • ABRIEFSTIGKEIT

PEI 1
Pavimentos sujeitos a tráfego ligeiro, aplicados em ambientes protegidos de agentes abrasivos e cortantes, tipo areias e gravilhas. Aplicações: Quarto de dormir e banhos privados. Floors subject to light traffic and protected from abrasive and scratching agents such as sand, gravel, etc. These floor tiles may be used in bedrooms or bathrooms of private dwellings.

PEI 2
Pavimentos sujeitos a tráfego médio/leve em ambientes protegidos de agentes abrasivos e cortantes, tipo areias e gravilhas. Aplicações: todas as divisões de habitação particular, excepto em cozinhas e corredores. Floors exposed to medium-light traffic and protected from abrasive and scratching agents such as sand, gravel, etc. In general, these floor tiles may be used in private houses, except kitchens and halls.

PEI 3
Pavimentos sujeitos a tráfego médio, aplicados em ambientes protegidos de agentes abrasivos e cortantes, tipo areias e gravilhas. Aplicações: todas as divisões de habitações particulares, incluindo a cozinha, suites de hotéis, quartos de hospital, etc. Floors exposed to medium traffic and protected from abrasive and scratching agents such as sand, gravel, etc. These floor tiles are ideal for any part of the house, including the kitchen, hotel-rooms with relative facilities, hospital-rooms, etc.

PEI 4
Pavimentos sujeitos a tráfego médio/intenso, podendo ser aplicados em ambientes com acesso directo ao exterior. Aplicações: terraços, restaurantes, hotéis, escritórios, hospitais, etc. Floors exposed to medium-heavy traffic and not protected from abrasive and scratching agents such as sand, gravel, or have direct access to the outdoor. These floor tiles are ideal for terraces and public spaces with a medium-level use, such as restaurants, hotels, offices, hospitals, etc.

PEI 5
Pavimentos sujeitos a tráfego intenso, colocados em ambientes não protegidos de agentes abrasivos e cortantes, tipo areias e gravilhas e com acesso ao exterior. Aplicações: Locais públicos, como bares, restaurantes, hotéis, lojas, escolas, escritórios, hospitais, etc. Floors exposed to heavy traffic in rooms which are subject to abrasive and scratching agents such as sand or gravel, or have direct access to the exterior. These floor tiles are ideal for public places such as restaurants, hotels, shops, schools, offices, hospitals, etc.

FORMAS DE APLICAÇÃO • TILING INSTRUCTIONS • FAÇONS DES POSE • VERLEFUNGARTEN

Aplicação em contra fiada não recomendada a mais de 1/3 da peça.
 It's not recommended laying the pieces more than 1/3 of the length of the tile.
 Pose conseillée avec un décalage entre chaque carreau non supérieur à 1/3 de la longueur du carreau même.
 Bei einer versetzten Verlegung empfehlen wir 1/3 (zweidrittel) Verbandverlegung.

Correcto / Correct

1/3 Peça • Piece • Carreaux

Incorrecto / Incorrect

1/2 Peça • Piece • Carreaux

Quando se trata de produtos com relevo nas suas peças (p.ex Coleção DECK), a aplicação das peças na mesma direcção podem apresentar um ligeiro desalinhamento intrínseco ao produto. Recomenda-se a utilização de junta aproximadamente, 3 mm.
 When applying pieces in the same direction, the slight deviation of the flat part and/or stripes (eg. DECK collection) is a characteristic intrinsic to the product. We recommend the use of joint of approximately 3mm.
 Lors de la pose de carreaux structurés dans le même sens (par ex. la collection DECK), un léger décalage de l'alignement de la partie lisse et/ou rayures est une caractéristique intrinsèque du produit. Nous recommandons l'utilisation d'un joint d'environ 3mm.
 Wenn es sich um Produkte mit Prägung handelt (z.B. DECK Kollektion), kann die Verlegung der Fliesen in die selbe Richtung eine eigene optische Verlagerung präsentieren. Hier wird eine Fuge von etwa 3mm empfohlen.

VARIAÇÕES DE TONALIDADE • VARIATION IN TONE • VARIATIONS DE TONALITÉ • FARBABWEICHUNGENN

V1

V2

V3

V4

UNIFORME • UNIFORM	SUAVE • SOFT • LÉGER • LEICHT	ELEVADA • HIGH • ÉLEVÉE • STARK	ALEATORIA • RANDOM • ALÉATOIRE • WILLKÜRLICH
Produto sem destonificação. As diferenças entre peças são mínimas.	As diferenças entre peças são visíveis, dentro de cores similares.	As diferenças entre peças são acentuadas. Quer a cor quer o desenho, podem variar significativamente.	As diferenças entre peças são muito acentuadas. As peças podem apresentar cores totalmente diferentes umas das outras.
Product without tone changes. Differences between tiles are minimum.	Differences between tiles are noticeable, within the same range of colour.	As diferenças entre peças são acentuadas. Quer a cor quer o desenho, podem variar significativamente.	Differences between tiles are very clear. Tiles can present completely different colours from one to the other.
Produit sans détonification. Les différences entre les pièces sont minimales.	Les différences entre les pièces sont visibles, dans des couleurs semblables.	Les différences entre les pièces sont accentuées. Aussi bien la couleur comme le dessin, peuvent varier de façon assez importante.	Les différences entre les pièces sont très accentuées. Les pièces peuvent présenter des couleurs totalement différentes les unes des autres.
Produkt ohne Farbabweichungen. Die Unterschiede sind minimal.	Die Unterschiede zwischen de Fliesen sind erkennbar innerhalb der Farbpalette.	Die Unterschiede zwischen den Fliesen sind beachtlich, sowohl die Farbe als auch das Design können deutlich variieren.	Die Unterschiede zwischen den Fliesen sind sehr deutlich. Die Fliesen können unter sich verschiedene Farben aufweisen.

LIMPEZA E MANUTENÇÃO

Após a aplicação dos mosaicos e respectiva junta é e extrema importância efectuar as operações de limpeza de obra, de forma a eliminar os resíduos de aplicação (cimentos, colas, massa de juntas, tintas) bem como possíveis resíduos superficiais do material. Recomenda-se que, imediatamente após a junta secar, se limpe os excessos destes produtos com um pano humedecido (Segundo sempre as indicações do fabricante).

A maioria dos problemas manifestados após a obra deve-se a uma má e por vezes inexistente limpeza após a aplicação, consultar a tabela:

TIPO DE SUJIDADE INCRUSTADA	PRODUTO FILA RECOMENDADO *
Resíduos de cimento, resíduos calcários, resíduos óxidos, ferrugem.	DETERDEK PRO
Resíduos de junta epoxi ou resinosa.	FILACR10
Sujidade normal / diária ligeira.	FILACLEANER PRO
Sujidade intensa (comida, óleo, azeite, café, graxa), resíduos de detergentes e sabão, borracha/pneus, tintas, etc.	FILAPS87 PRO
Atenção: Respeitar as precauções de utilização e diluição aconselhadas pelo produtor dos detergentes. Não utilizar produtos que contenham ácido fluorídrico e/ou os seus derivados. * Mais informação: www.filasolutions.com Para mais informações, por favor consulte as FAQ em www.gresart.pt	

NETTOYAGE ET ENTRETIEN

Après pose et jointement des carreaux, il est extrêmement important d'effectuer les opérations de nettoyage de fin de chantier afin d'éliminer tous résidus (ciment, joint, colles et Peintures), même superficiels, de la mise en oeuvre. Il est conseillé que, immédiatement après le séchage du joint, que le surplus des produits soient retirés à l'aide d'un torchon humide (en Suivant toujours les indications du fabricant).

La plupart des problèmes qui surgissent après la fin du chantier sont du à un mauvais voir inexistant nettoyage après Plus spécifique voir tableau ci-dessous:

TYPE DE SALETÉ	PRODUIT RECOMMANDÉ PAR FILA *
Dépôts/efflorescences de calcaire, encres, rouille et oxydation, mortier	DETERDEK PRO
Déchet époxy ou joint en résine.	FILACR10
Saleté légère normale / quotidienne	FILACLEANER PRO
Saleté intense (vin , glace et café , thé grasses, caoutchouc de pneus/ peinture , huile de graissage vernis , cire/ crayon de papier, resines, etc.)	FILAPS87 PRO
Attention: Respectez les précautions d'emploi et de dilution recommandées par le fabricant du détergent. N'utilisez pas de produits contenant de l'acide fluorhydrique et / ou ses dérivés. * Plus d'informations : www.filasolutions.com Pour plus d'informations, veuillez consulter la section des Questions Fréquentes sur notre site web.	

NOTAS IMPORTANTES
Todas as imagens apresentadas neste catálogo são meramente ilustrativas, carecendo sempre a confirmação "in loco" das diferenças de tonalidades dos produtos e ambientes. A Gresart, SA, reserva-se o direito de alterar e/ou anular, total ou parcialmente, qualquer um dos formatos, referências e especificações técnicas apresentados neste catálogo. As especificações técnicas são válidas unicamente para os produtos de 1ª escolha. As dimensões apresentadas neste catálogo, correspondem a dimensões nominais (aproximadas), pelo que deve confirmar as dimensões exactas na tabela de calibres dos diferentes formatos. Os pesos apresentados nas tabelas de embalagem e paletização são meramente indicativos.

IMPORTANT INFORMATION
All images shown in this catalog are for illustrative purposes only. Gresart, SA reserves the right to change and / or cancel, in whole or in part, any of the formats, references and technical specifications presented in this catalog. The technical specifications are valid only for 1st choice products. The dimensions shown in this catalog correspond to nominal (approx.) dimensions, so please confirm the exact dimensions in the caliber table of the different formats. The weights shown in the packing list are indicative only.

NOTES IMPORTANTES
Toutes les images figurant dans ce catalogue ne sont qu'illustratives, obligeant toujours à la confirmation "in loco" des différences de tonalité au niveau des carreaux bien comme au niveau des ambiances. Gresart, SA, se réserve le droit de modifier et/ou supprimer, totalement ou partiellement, quelconque format, référence et spécification technique présentés dans ce catalogue. Les spécifications techniques ne sont valables que pour les produits de 1er choix. Les dimensions indiquées dans ce catalogue correspondent aux dimensions nominales (approximatives), c'est pourquoi il faudra confirmer les dimensions exactes dans le tableau des calibres pour les différents formats. Les poids indiqués dans la liste de colisage bien comme la palettisation sont à titre indicatif.

WICHTIGE HINWEISE
Alle bilder in diesem katalog sind nur illustrativ, deshalb sollte jeweils eine bestätigung der verschieden tonalitäten der produkte und umgebung vor ort erfolgen. Gresart, SA, behält sich das recht auf jegliche formate, referenzen oder technische spezifikationen aus diesem katalog ganz- oder teilweise zu ändern und/oder zu widerrufen. Die technischen spezifikationen gelten nur für 1. Wahl produkte. Die größenangaben in diesem katalog entsprechen der (ungefähren) nominalgrößen. Aus diesem grund, müssen die exakten größen in der tabelle mit den kalibern des jeweiligen formats bestätigt werden. Die dargestellten gewichte in der tabelle der verpackung und palettisierung sind nur richtungsweisend.

CLEANING AND MAINTENANCE

After laying the tiles and grouting it is of outmost importance to perform the final cleaning procedures in order to eliminate any remaining residues (cement, grout , glue, paint) and also any other possible superficial residues. It is recommended that, immediately after the grout dry; the tile fixer should wipe the excess with a wet cloth (always following the manufacturer's instructions).

Most of the noticed problems, once the laying works are complete, are due to inefficient / non existing cleaning Kindly check the chart:

TIPO OF STAIN	PRODUCTS ADVISED BY FILA *
Cement deposits, calcareous matter/deposits, rust and oxides, mortar	DETERDEK PRO
Epoxy or resin deposits.	FILACR10
Normal / daily dirt.	FILACLEANER PRO
Heavy dirt (food, rubber, tire marks, grease, wine, coffee), detergent and soap residues, paints, etc.	FILAPS87 PRO
Attention: Observe the precautions for use and dilution recommended by the detergent manufacturer. Do not use products containing hydrofluoric acid and / or its derivatives. * For more information: www.filasolutions.com For more information, please check FAQ in www.gresart.pt	

REINIGUNG UND INSTANDHALTUNG

Nach dem verlegen und ausfugen der fliesen ist es sehr wichtig die reinigungsvorgänge durchzuführen, damit alle rückstände beseitigt werden (mörtel, fugen, klebstoffe, tintenflecke) Sowie eventuelle oberflächliche rückstände. Nachdem die fugen trocken ist, sollen die reste sofort mit einem nassen tuch gereinigt werden (immer die anweisungen vom hersteller folgend).

Die meisten angebrachten problemen nach den arbeiten stammen aus eine schlechte und oft inexistente reinigung nach dem verlegen - für diese reinigung empfehlen wir Kesselsteinlösemittel mit säure; bei der tägliche reinigung empfehlen wir die verwendung von neutral reinigungsmittel und bei der reinigung von spezifische flecken bitte u.A. Anweisungen Sehen:

ART DER VERSCHMUTZUNG	VON FILA EMPFEHLENDE * REINIGUNGSMITTEL
Kalkablagerungen/ablagerungen, tinte, rost und oxydation, mörtel	DETERDEK PRO
Epoxidharz- oder harzdichtung.	FILACR10
Täglicher / normaler schmutz	FILACLEANER PRO
Schwerer schmutz (gummi, harz oder lack, maschinenöl, lack, schmiere, wachsstift, bitumen, wachs, harz, bier/wein, eis und kaffee, etc.)	FILAPS87 PRO
Achtung: Beachten sie die vom waschmittelhersteller empfohlenen vorsichtsmaßnahmen für die anwendung und verdünnung. Verwenden sie keine produkte, die flusssäure und / oder deren derivate enthalten. * Weitere informationen: www.filasolutions.com Weitere informationen finden Sie auf unserer website.	

EN 14411

	Características Técnicas Technical Data Caractéristiques Techniques Technische Daten Datos Tecnicos	Norma de Ensaio Test Norm Norme du Test Testnormen Norma de Prueba	Anexo • Annex Annexe • Anhang	G	Anexo • Annex Annexe • Anhang	J	Anexo • Annex Annexe • Anhang	L	
			Grupo • Group Groupe • Gruppe	BIA	Grupo • Group Groupe • Gruppe	BIIA	Grupo • Group Groupe • Gruppe	BIII	G R E S A R T ^o C E R A M I C A
	Comprimento e Largura Length and Width Longueur et Largeur Länge und Breite Longitud y Anchura								Garantido Guaranted Garanti Gewährleistet Garantizado
	Espeçura Thickness Épaisseur Dichte Grosor		± 5 %		± 5 %		± 10 %		Garantido Guaranted Garanti Gewährleistet Garantizado
	Rectilinearidade das Arestas Edge Warpages Rectitude des Arêtes Geradlinigkeit der Kanten Rectitud de los Bordos	EN ISO 10545-2	± 0,5 %		± 0,5 %		± 0,3 %		Garantido Guaranted Garanti Gewährleistet Garantizado
	Medida da Ortogonalidade Rectangularity Angularité Rechtwinkligkeit der Kanten Grado de Ortogonalidad		± 0,5 %		± 0,5 %		± 0,5 %		Garantido Guaranted Garanti Gewährleistet Garantizado
	Medida da Planaridade Surface Flateness Planité de la Superficie Ebenflächigkeit Medición de Planaridad		± 0,5 %		± 0,5 %		± 0,5 %		Garantido Guaranted Garanti Gewährleistet Garantizado
	Absorção de Água Water Absorption Absorption D'eau Wasseraufnahme Absorción de Agua	EN ISO 10545-3	E ≤ 0,5%		3% < E < 6%		E ≥ 10%		Garantido Guaranted Garanti Gewährleistet Garantizado
	Resistência à Flexão Breaking Strength Résistance à la Flexion Biegefestigkeit Resistencia a la Flexión	EN ISO 10545-4	≥ 35 N/mm2		≥ 22 N/mm2		≥ 12 N/mm2		Garantido Guaranted Garanti Gewährleistet Garantizado
	Força de Rutura Breaking Strenght Force de Rupture Bruchfestigkeit Resistencia a la Rotura		≥ 1300 N		≥ 1000 N		≥ 600 N		Garantido Guaranted Garanti Gewährleistet Garantizado
	Resistência à Abrasão Resistance to Abrasion Résistance à Labrasion Abnutzungsbeständigkeit Resistencia a la Abrasion	EN ISO 10545-7		Segundo os Valores do Fabricante According to Manufacter Requirements Selon les Valeurs du Fabricant Gemäss der Werte des Herstellers Según los Valores del Fabricante		Segundo os Valores do Fabricante According to Manufacter Requirements Selon les Valeurs du Fabricant Gemäss der Werte des Herstellers Según los Valores del Fabricante	—		Indicação na Tabela de Preços Indication on Price List Indication sur la Liste de Prix Hinweis auf der Preisliste Indicación en la Tabla de Precios
	Resistência ao Fendilhamento Cracking Resistance Résistance aux Trésaillures Abnutzungsbeständigkeit Resistencia a lo Agrietado	EN ISO 10545-11		Exigido Required Exigée Gefordert Exigido		Exigido Required Exigée Gefordert Exigido	Exigido Required Exigée Gefordert Exigido		Garantido Guaranted Garanti Gewährleistet Garantizado
	Resistência ao Gelo Frost Resistance Résistance au Gel Frostbeständigkeit Resistencia al Hielo	EN ISO 10545-12		Exigido Required Exigée Gefordert Exigido		Exigido Required Exigée Gefordert Exigido	—		Garantido Guaranted Garanti Gewährleistet Garantizado
	Resistência aos Ácidos e Bases Resistance against Acids and Bases Résistance aux Acides et Bases Beständigkeit Gegen Säuren u Laugen Resistencia a los Ácidos y Bases	EN ISO 10545-13		Segundo os Valores do Fabricante According to Manufacter Requirements Selon les Valeurs du Fabricant Gemäss der Werte des Herstellers Según los Valores del Fabricante		Segundo os Valores do Fabricante According to Manufacter Requirements Selon les Valeurs du Fabricant Gemäss der Werte des Herstellers Según los Valores del Fabricante	Mínimo: GLB Minimum: GLB Minimum: GLB Minimum: GLB		Garantido Guaranted Garanti Gewährleistet Garantizado
	Resistência aos Produtos de Limpeza Domesticos Resistance to Household Cleaning Products Résistance aux Produits Ménagers de Nettoyage Beständigkeit Gegen Haushaltsprodukte Resistencia a los Productos de Limpieza Domésticos			Mínimo: GB Minimum: GB Minimum: GB Minimum: GB		Mínimo: GB Minimum: GB Minimum: GB Minimum: GB			Garantido Guaranted Garanti Gewährleistet Garantizado
	Resistência às Manchas Staining Resistance Résistance aux Taches Beständigkeit Gegen Flecken Resistencia a las Manchas	EN ISO 10545-14		Mínimo: Classe 3 Minimum: Classe 3 Minimum: Klasse 3 Mínimo: Clase 3		Mínimo: Classe 3 Minimum: Classe 3 Minimum: Klasse 3 Mínimo: Clase 3			Garantido Guaranted Garanti Gewährleistet Garantizado



G R E S A R T® ■
C E R Á M I C A

GRESART - CERÂMICA INDUSTRIAL S.A.
APARTADO 39 - EC DE OLIVEIRA DO BAIRRO | 3771-954 OLIVEIRA DO BAIRRO | PORTUGAL
TEL. +351 234 740 200 | FAX. +351 234 747 462
GRESART@GRESART.COM | WWW.GRESART.COM



