

RESIDENTIAL
RESIDENCIAL
/20





ÍNDICE /

INDEX · TABLE · ИНДЕКС

SIMBOLOGÍA ICONOGRAPHY	02	ESQUEMAS DE COLOCACIÓN MF MULTIFORMAT LAYING PATTERNS	176 - 177
ÍNDICE SERIES SERIES INDEX	03	SOLUCIONES TÉCNICAS TECHNICAL SOLUTIONS	178 - 187
SOBRE NOSOTROS ABOUT US	04 - 09	RECOMENDACIONES COLOCACIÓN TILING RECOMMENDATIONS	188 - 191
SERIES MARBLE MARBLE SERIES	10 - 31	PROCESO EXTRUSIÓN EXTRUSION PROCESS	192 - 193
SERIES WOOD WOOD SERIES	32 - 61	CARACTERÍSTICAS TÉCNICAS TECHNICAL DATA	194 - 199
SERIES URBAN URBAN SERIES	62 - 87	LISTA DE EMBALAJE PACKING LIST	200 - 207
SERIES STONE STONE SERIES	88 - 153		
SERIES EARTH EARTH SERIES	154 - 169		
SERIES METAL METAL SERIES	170 - 175		

SIMBOLOGÍA /

ICONOGRAPHY · ICONOGRAPHIE · УСЛОВНЫЕ ОБОЗНАЧЕНИЯ



RESISTENCIA AL DESLIZAMIENTO (rampa pie calzado) · ANTI-SLIP RESISTANCE (ramp)
RÉSISTANCE AU GLISSEMENT (pied chaussé) · СОПРОТИВЛЕНИЕ СКОЛЬЖЕНИЮ (если ходит обутым)



RESISTENCIA AL DESLIZAMIENTO (pie descalzo) · ANTI-SLIP RESISTANCE (barefoot)
RÉSISTANCE AU GLISSEMENT (pied nu) · СОПРОТИВЛЕНИЕ СКОЛЬЖЕНИЮ (босые ноги)



RESISTENCIA AL DESLIZAMIENTO (C.T.E.) · ANTI-SLIP RESISTANCE (C.T.E)
RÉSISTANCE AU GLISSEMENT (C.T.E.) · СОПРОТИВЛЕНИЕ СКОЛЬЖЕНИЮ (C.T.E.)



ABSORCIÓN DE AGUA · WATER ABSORPTION
ABSORPTION D'EAU · ВОДОПОГЛОЩЕНИЕ



RESISTENCIA A LOS AGENTES QUÍMICOS · CHEMICAL RESISTANCE
RÉSISTANCE AUX PRODUITS CHIMIQUES · СТОЙКОСТЬ К ВОЗДЕЙСТВИЮ ХИМИКАТОВ



RESISTENCIA A LA HELADA · FROST RESISTANCE
RÉSISTANCE AU GEL · МОРОЗОСТОЙКОСТЬ



IMPRESIÓN DIGITAL · DIGITAL PRINTING
DIGITAL IMPRESSION · ЦИФРОВАЯ ПЕЧАТЬ



DORSO ESTRIADO EN COLA DE MILANO · DOVE TAIL PROFILE
FAÇONNAGE EN QUEUE D'ARONDE AU DOS DES CARREAUX · Ласточкин хвост» на задней стороне плитк



V1

LIGERA VARIACIÓN EN TONALIDAD Y GRÁFICAS · SLIGHT VARIATION IN TONE AND GRAPHICS
LÉGÈRE VARIATION DE LA TEINTE ET DES GRAPHIQUES · НЕБОЛЬШОЕ РАЗЛИЧИЕ В ОТТЕНКАХ И РИСУНКАХ



V2

MODERADA VARIACIÓN EN TONALIDAD Y GRÁFICAS · MODERATE VARIATION IN TONE AND GRAPHICS
VARIATION MODÉRÉE DE LA TEINTE ET DES GRAPHIQUES · СРЕДНЕЕ РАЗЛИЧИЕ В ОТТЕНКАХ И РИСУНКАХ



V3

CONTRASTE DE TONALIDAD Y VARIEDAD DE GRÁFICAS · CONTRAST IN TONE AND VARIETY OF GRAPHICS
CONTRASTE DE TEINTE ET VARIÉTÉ DE GRAPHIQUES · КОНТРАСТНЫЕ ОТТЕНКИ И РАЗНООБРАЗИЕ РИСУНКОВ



RELIEVE SUPERFICIAL · SUPERFICIAL RELIEF
RELIEF SUPERFICIEL · РЕЛЬЕФНАЯ ПОВЕРХНОСТЬ



RECTIFICADO · RECTIFIED
CARRELAGE RECTIFIÉ · РЕКТИФИЦИРОВАННАЯ ПЛИТКА



DISEÑO 3D · 3D DESIGN
DESIGN 3D · ДИЗАЙН 3D

ÍNDICE SERIES /

SERIES INDEX · TABLE DES SÉRIES · СОДЕРЖАНИЕ

1. MARBLE

MARKINA	10 - 19
MARBLES	20 - 31

2. WOOD

YOHO	32 - 49
KIOTO	50 - 55
NATURA	56 - 61

3. URBAN

ÓPERA	62 - 81
MEDITERRÁNEO	82 - 87

4. STONE

MILÁN	88 - 101
ALBAROC	102 - 115
LITOS	116 - 129
ROCA	130 - 135
MANHATTAN	136 - 143
PETRA	144 - 149
VEGA	150 - 153

5. EARTH

LUCCA	154 - 163
ALHAMAR	164 - 169

6. METAL

METÁLICA	170 - 175
----------	-----------

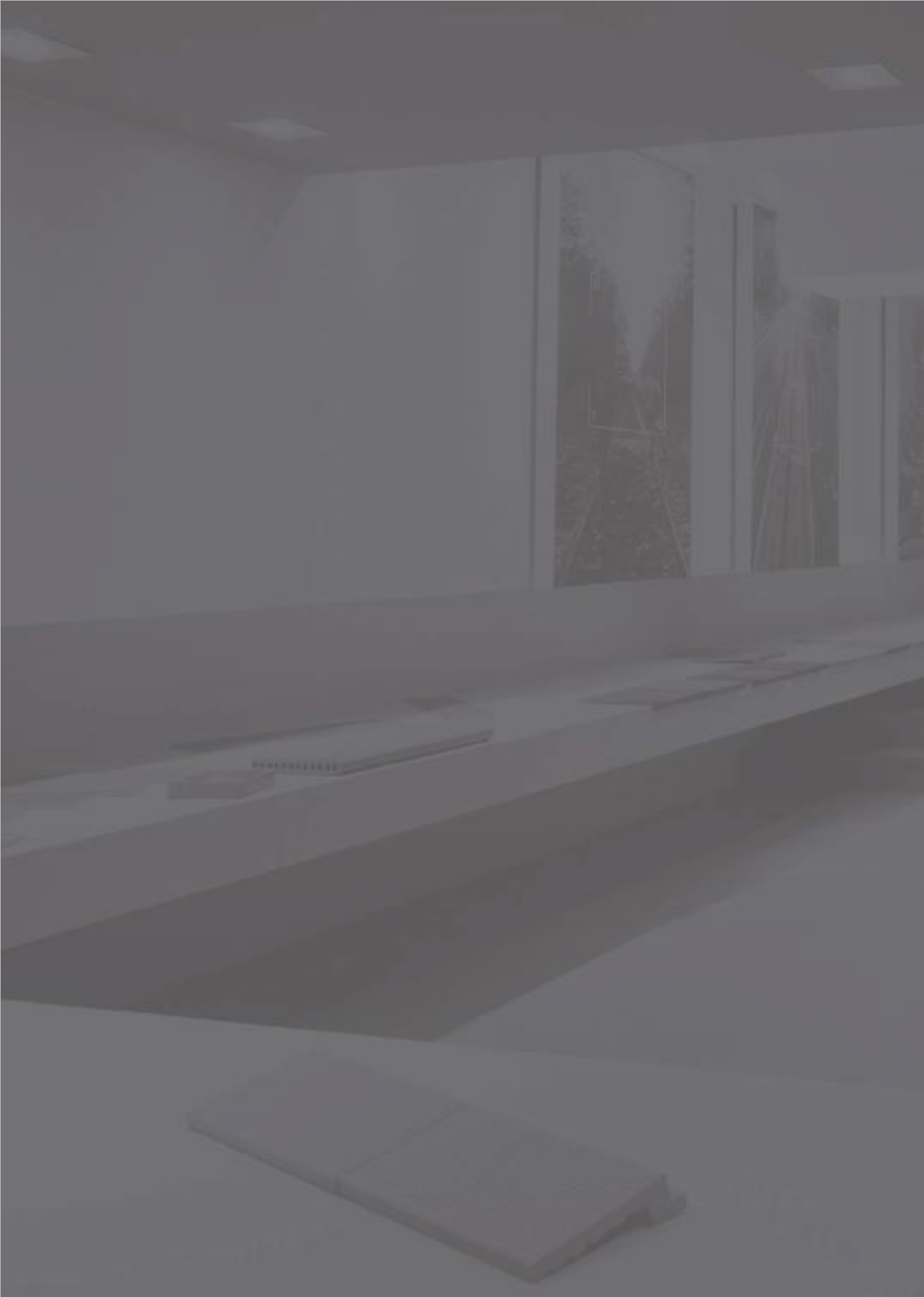

EMPRESA /

COMPANY · ENTERPRISE · КОМПАНИЯ

Al principio de los años 70, EXAGRES se introduce en el mercado del extrusionado. Desde su fundación, la empresa desempeña un papel fundamental de liderazgo en la investigación de materias primas y procesos productivos, poniendo al alcance de grandes profesionales, soluciones en la aplicación cerámica, desarrollando piezas especiales como peldaños, esquinas, ángulos, vierteaguas, bordes de piscinas, etc. que posicionan a Exagres, como líder en la fabricación en Europa. Pero esta Innovación y Desarrollo se traslada al mercado en voz de un equipo con talento, cercano y a la escucha de cada una de las necesidades de clientes y profesionales. En la actualidad, Exagres se afianza, con la seguridad de 40 años de innovación tecnológica, conocimiento y entendimiento de múltiples necesidades para lograr productos de calidad y crear valor añadido a través una cultura de gestión integral y mejora continua, fundamentada en la calidad del servicio y producto, la protección ambiental, la seguridad y salud de las personas que forman parte de nuestra empresa.

At the beginning of the 70s, EXAGRES joined the market of extruded products. Since it was founded, the company has played a fundamental role in the leadership researching raw materials and production processes, providing solutions for ceramic applications in the hands of great professionals, developing special pieces such as steps, corners, angles, gutters, pool edging, etc. these facts position Exagres as a leading manufacturer in Europe. Innovation and development are transferred to the market through the voice of a talented, friendly team that is capable to listen to each of the needs of their customers and professionals. Currently, Exagres is strengthened of 40 years of technological innovation, knowledge and understanding of multiple needs in order to achieve quality products, creating added value through a culture of integral management and continuous improvement, based on the quality of the service and product, environmental protection and the health and safety of the people who form part of our company.

Au début des années 70, EXAGRES pénètre dans le marché de l'extrusion. Depuis sa fondation, l'entreprise remplit un rôle essentiel de leadership dans la recherche de matières premières et processus de production, mettant à la portée des grands professionnels des solutions dans l'application céramique, en développant des pièces spéciales telles que des marches, des coins, des angles, des revingots, des rebords de piscines, etc., qui placent Exagres à la tête de la fabrication en Europe. Cependant, cette innovation et ce développement sont transférés au marché au nom d'une équipe talentueuse, proche et à l'écoute de chacune des nécessités de clients et professionnels. À présent, Exagres se consolide, avec la sécurité de 40 ans d'innovation technologique, connaissance et compréhension de nécessités multiples pour obtenir des produits de qualité et créer de la valeur ajoutée à travers une culture de gestion intégrale et amélioration continue, qui se fonde sur la qualité du service et du produit, la protection environnementale, la sécurité et la santé des personnes qui font partie de notre entreprise.

Компания EXAGRES начала свою деятельность на рынке экструдированной керамики в начале 70-х годов. С момента своего основания она стала одним из лидеров в научных исследованиях в области первичного сырья и производственных процессов, занимая ведущую позицию среди производителей в Европе. Exagres предлагает профессионалам различные решения в области применения керамики, в том числе специальные элементы: ступени, внутренние и внешние углы, водостоки, бортики бассейнов и др. Инновации и опытные разработки осуществляет команда талантливых сотрудников, которые внимательно относятся к мнению клиентов и профессионалов, стремясь удовлетворять все их потребности. Exagres имеет 40-летний опыт в области технологических инноваций. Ее персонал располагает обширными знаниями, в том числе о различных потребностях и запросах, что позволяет создавать высококачественные продукты с дополнительной ценностью. В компании существует особая культура комплексного менеджмента и постоянного совершенствования, основанная на качестве услуг и продукции, защите окружающей среды, а также на обеспечении безопасности и охране здоровья трудящихся.

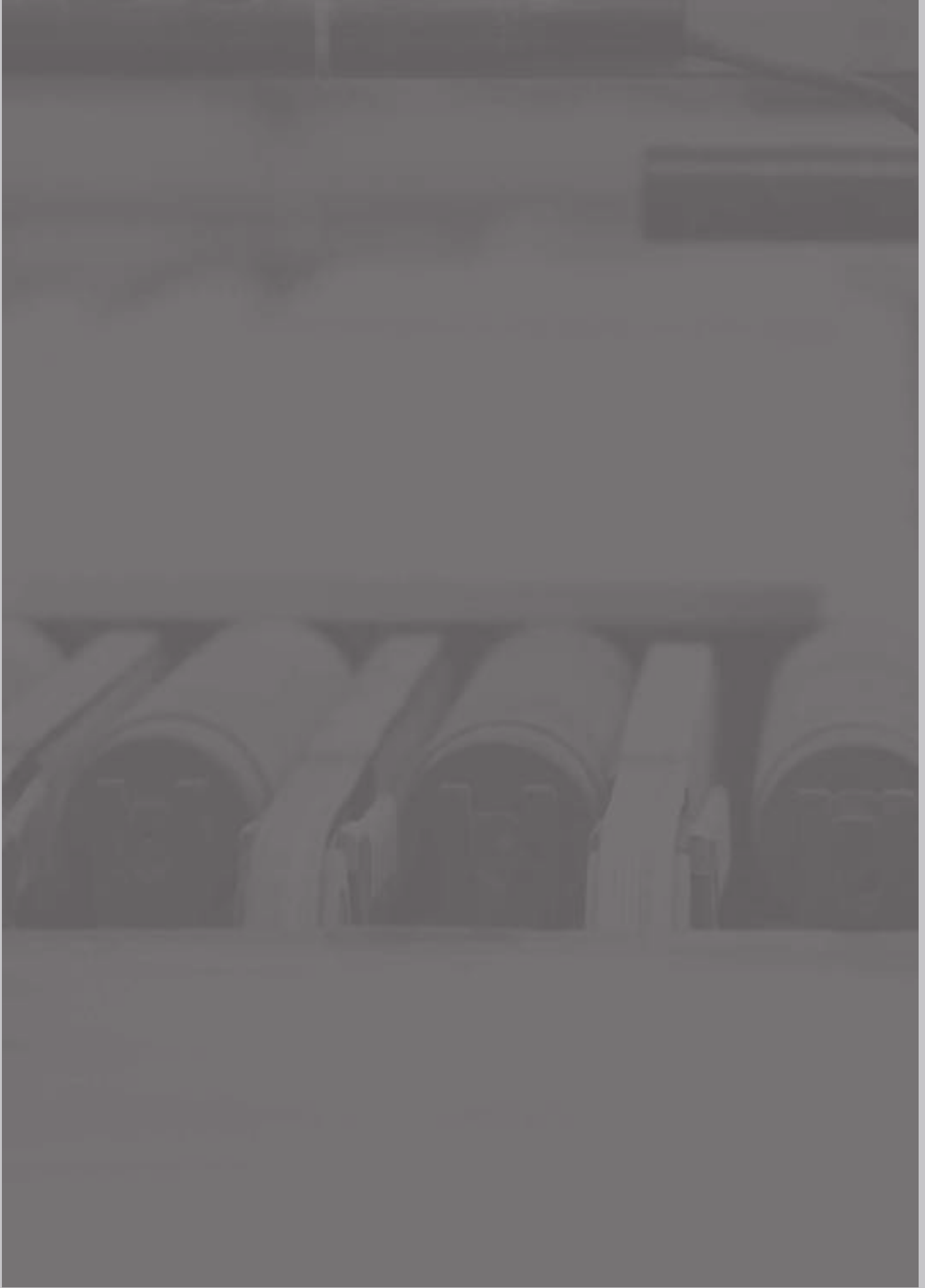

PRODUCTO /

PRODUCT · PRODUIT · ПРОДУКТЫ

Las exigencias en arquitectura varían con el paso de los años, por ello, EXAGRES propone soluciones y superficies que garantizan altos niveles de prestaciones técnicas y estéticas a la vez que respetan las necesidades de la construcción. El producto de Exagres, con su particular sistema de fabricación, la extrusión, es capaz de generar diferentes formatos y tipos de piezas especiales, todo ello, facilitando su colocación al profesional. Las series de Exagres garantizan funcionalidad y un alto contenido estético en cada tipo de proyecto. Desde la arquitectura urbana, el uso industrial e incluso en la realización de todo tipo de diseños de carácter residencial en interiores, exteriores y recubrimiento de piscinas.

The requirements of architecture vary over time, therefore, EXAGRES proposes solutions and surfaces that guarantee high levels of technical and aesthetic qualities while also respecting the needs of the construction. The Exagres product, with its unique manufacturing system, extrusion, is capable of generating different formats and types of special pieces, thus facilitating placement by a professional. The Exagres series guarantee functionality and a high aesthetic content in each type of project. From urban architecture, industrial use and even use in all types of designs of a residential nature for interiors, exteriors and swimming pool cladding.

Les exigences en architecture varient au fil des années. De ce fait, EXAGRES propose des solutions et des surfaces qui garantissent de hauts niveaux de prestations techniques et esthétiques en respectant en même temps les nécessités de la construction. Le produit d'Exagres, avec son système particulier de fabrication, l'extrusion, est capable de générer plusieurs formats et types de pièces spéciales, le tout en facilitant sa pose au professionnel. Les séries d'Exagres garantissent la fonctionnalité et une haute teneur esthétique dans chaque type de projet. Depuis l'architecture urbaine, l'utilisation industrielle et même dans la réalisation de toute sorte de conceptions à caractère résidentiel en intérieur, extérieur et recouvrement de piscines.

С течением времени требования, предъявляемые к различным материалам в архитектуре, варьируются. Поэтому EXAGRES предлагает решения, которые не только гарантируют высокий уровень технических и эстетических характеристик, но также обеспечивают соответствие потребностям строительства. Продукты компании Exagres производятся с помощью особой технологии-экструзии, которая позволяет создавать различные форматы и элементы разных форм, что облегчает процесс укладки. Серии Exagres гарантируют функциональность и прекрасные эстетические характеристики для каждого типа проекта, включая городскую архитектуру, промышленное использование, интерьеры и наружные пространства всевозможных жилых домов, а также покрытия для бассейнов.

GESTIÓN PARA LA CALIDAD /

QUALITY MANAGEMENT · GESTION POUR LA QUALITÉ · УПРАВЛЕНИЕ КАЧЕСТВОМ

En Exagres somos responsables con el medio ambiente. Por ese motivo utilizamos las herramientas de gestión adecuadas para garantizar la calidad, la protección del medio ambiente, la seguridad y la salud.

At Exagres we are environmentally responsible. For this reason we use the appropriate management tools to guarantee quality, environment, safety and health.

Chez Exagres nous sommes responsables de l'environnement. Pour cette raison, nous utilisons les outils de gestion adaptés afin de garantir la qualité, l'environnement, la sécurité et la santé.

В Exagres мы ответственно относимся к охране окружающей среды. Именно поэтому мы используем инструменты управления, обеспечивающие высокое качество продукции, защиту окружающей среды, безопасность и охрану здоровья.



LIBRERÍA BIM /

BIM LIBRARY · LIBRAIRIE BIM · КНИЖНЫЙ

Exagres se suma al sistema de trabajo en BIM, distribuyendo a los agentes intervinientes de la edificación sus productos cerámicos. Los modelos BIM contienen los datos necesarios para que los prescriptores puedan elegir el material siguiendo los criterios pertinentes para cada uso. Además, el arquitecto podrá generar imágenes de alta calidad, para poder mostrar a sus clientes el ambiente con mayor fidelidad.

Exagres joins the BIM work system, distributing its ceramic products to the agents involved in building. BIM models contain the required data in order to construction specifiers can choose the right material according to the relevant criteria for each use. Furthermore, the architect will be able to generate high quality images to show the environment to his customers with greater accuracy.

Exagres s'associe au système de travail BIM, en distribuant aux agents intervenants de la construction leur produits en céramique. Les modèles BIM contiennent les données nécessaires pour que les prescripteurs puissent choisir le matériel en suivant les critères pertinents pour chaque usage. En plus, l'architecte pourra générer des images d'haute qualité, pour pouvoir montrer aux clients l'ambiance avec plus de fidélité.

Exagres присоединяется к современной системе информационного моделирования BIM, распределяя среди участвующих лиц достижения в керамической деятельности. Модели BIM содержат в себе все необходимые данные, позволяющие выбирать материал в соответствии с особенностями каждого использования. Кроме того, архитектор сможет генерировать высококачественные изображения и демонстрировать клиентам пространства с большей точностью.



CERTIFICACIONES /

CERTIFICATIONS · CERTIFICATIONS · СЕРТИФИКАТЫ

La Confederación Española de la Pequeña y Mediana Empresa (CEPYME) ha seleccionado a Exagres como una de las 500 empresas que lideran el crecimiento empresarial, tanto por sus resultados obtenidos en los últimos años, como por su capacidad para generar actividad y empleo, su potencial de innovación y su proyección internacional.

The Spanish Confederation of Small and Medium-Size Enterprises (CEPYME) has chosen Exagres as one of the 500 companies that lead business growth due to its results obtained in recent years, the ability to generate activity and employment, its potential of innovation and international projection.

La Confederation Espagnole de la petite et moyenne entreprise (CEPYME) a sélectionné a Exagres comme l' une de 500 entreprises qui mènent la croissance entrepreneuriale tant per ses excellents résultats obtenus dans les dernières années, que pour sa capacité pour générer activité et emploi, son potentiel d' innovation et sa projection international.

Согласно исследованиям Испанской Конфедерации Малых и Средних Предприятий (CEPYME), Exagres вошла в рейтинг 500 быстрорастущих керамических производителей, как за результатами предыдущего года, так и способностью генерировать занятость, потенциал инноваций и международную деятельность

PREMIOS /

AWARDS · DISTINCTIONS · НАГРАДЫ



En la edición de la Feria Cevisama 2019, la nueva línea de suelo técnico cerámico Exadeck de Exagres fue galardonado con el premio "SOM CERÀMICA", otorgado por la Diputación de Castellón en reconocimiento a la innovación del producto cerámico para su uso en aplicaciones urbanas.

In Cevisama Fair 2019, the new line of ceramic technical floor , Exadeck by Exagres, was awarded the SOM CERÀMICA prize by the Council of Castellón in recognition of the innovation of the ceramic product for use in urban applications.

Dans l' édition de la foire Cevisama 2019 , la nouvelle ligne du sol technique céramique Exadeck d' Exagres a reçu le prix " SOM CERAMICA" décerné par la Diputación de Castellón en récompense a l' innovation du produit céramique pour usage dans des applications urbaines

На международной выставке Cevisama Fair 2019, Мэрия города Кастельон удостоила новую линию технического керамического пола Exadeck от Exagres, награды «SOM CERÀMICA», за достижения в области развития инновационного керамического продукта и его использования в городских условиях.

MARBLE

MARKINA

MODERN GRAPHIC MARBLE
LARGE FORMAT
STAIRS



COLORS:

BIANCO
NERO*

SIZES (cm):

100x100 cm
60x120 cm
14,5x120 cm

SIZES (inches):

39.4"x39.4"
23.7"x47.2"
5.7"x47.2"

*Sólo disponible en 60x120 cm y 14,5x120 cm.
Available only in 60x120 cm and 14,5x120 cm.



≡ | MARKINA

MARKINA / BIANCO

GRES EXTRUIDO · EXTRUDED KLINKER · GRÈS EXTRUDÉ · ЭКСТРУДИРОВАННЫЙ КЕРАМОГРАНИТ

* GRES PORCELÁNICO · PORCELAIN STONEWARE · GRÈS PORCELAINÉ · КЕРАМОГРАНИТ



R9
R11



C- 1
C- 3



Alb <1,5%
Bla <0,5%



v1



FORMATOS · SIZES · FORMATS · ФОРМАТЫ

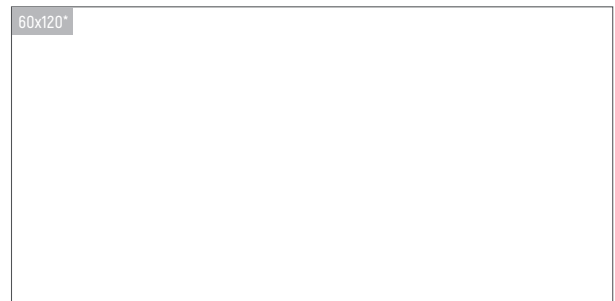
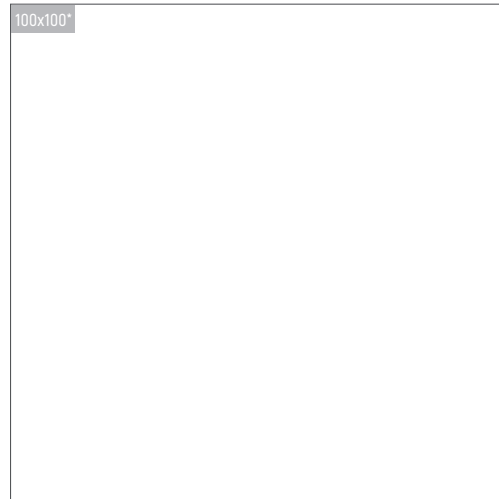

100x100*
100 x 100 cm - 39.4"x 39.4"

± 11 mm
rectificado, rectified
C-1/C-3

60x120*
60 x 120 cm - 23.7"x 47.2"

± 10,2 mm
rectificado, rectified
C-1/C-3

14,5x120*
14,5 x 120 cm - 5.7"x 47.2"

± 10,2 mm
C-1

* GRES PORCELÁNICO · PORCELAIN STONEWARE · GRÈS PORCELAINÉ · КЕРАМОГРАНИТ

PIEZAS ESPECIALES · SPECIAL PIECES · PIÈCES SPÉCIALES · СПЕЦИАЛЬНЫЕ ЭЛЕМЕНТЫ



PELDAÑO RECTO 120
33 x 120 x 3 cm - 13.0"x 47.2"x 1.2"

- ✕ 12 mm
- ☑ rectificado, rectified
- ☑ C-1/C-3



REMATE PELDAÑO RECTO
3 x 33 cm - 1.2"x 13.0"



ZANQUÍN RECTO DCHA/IZDA
40 x 18 cm - 15.7"x 7.1"

- ✕ 15 mm



RODAPIÉ
9 x 40 cm - 3.5"x 15.7"

- ✕ 15 mm

MARKINA / BIANCO

OUTOOR: MARKINA BIANCO 60x120 CM (C-3) - PELDAÑO RECTO 33x120x3 CM (C-3) - TABICA 14,5x120 CM





MARKINA / NERO

GRES EXTRUIDO · EXTRUDED KLINKER · GRÈS EXTRUDÉ · ЭКСТРУДИРОВАННЫЙ КЕРАМОГРАНИТ
* GRES PORCELÁNICO · PORCELAIN STONEWARE · GRÈS PORCELAINÉ · КЕРАМОГРАНИТ



R9

C-1

Alb <1,5%
Bla <0,5%

V1



FORMATOS · SIZES · FORMATS · ФОРМАТЫ

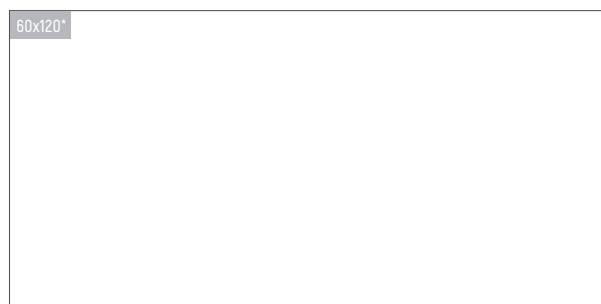

60x120*
60 x 120 cm - 23.7" x 47.2"

± 11,3 mm
rectificado. rectified
C-1

14,5x120*
14,5 x 120 cm - 5.7" x 47.2"

± 11,3 mm
C-1

* GRES PORCELÁNICO · PORCELAIN STONEWARE · GRÈS PORCELAINÉ · КЕРАМОГРАНИТ

PIEZAS ESPECIALES · SPECIAL PIECES · PIÈCES SPÉCIALES · СПЕЦИАЛЬНЫЕ ЭЛЕМЕНТЫ



PELDAÑO RECTO 120
33 x 120 x 3 cm - 13.0" x 47.2" x 1.2"

- ✂ 12 mm
- 🔪 rectificado, rectified
- 📦 C-1/C-3



REMATE PELDAÑO RECTO
3 x 33 cm - 1.2" x 13.0"



ZANQUÍN RECTO DCHA/IZDA
40 x 18 cm - 15.7" x 7.1"

- ✂ 15 mm



RODAPIÉ
9 x 40 cm - 3.5" x 15.7"

- ✂ 15 mm

MARKINA / NERO

INDOOR: MARKINA NERO 60x120 CM (C-1) - MARKINA BIANCO 100x100 CM (C-1) - PELDAÑO RECTO 33x120 CM (C-1) - TABICA 14,5x120 CM





MARBLE

MARBLES

ELEGANCE & TIMELESSNESS

IN & OUTDOOR

STAIRS

SWIMMING POOLS



COLORS:

CALACATTA
TRAVERTINO
CREMA MARFIL

SIZES (cm):

60x120 cm
14,5x120 cm
33x66,5 cm

SIZES (inches):

23.7"x47.2"
5.7"x47.2"
13.0"x26.2"



TRAVERTINO 60x120 CM [C-1]

MARBLES / CALACATTA

GRES EXTRUIDO · EXTRUDED KLINKER · GRÈS EXTRUDÉ · ЭКСТРУДИРОВАННЫЙ КЕРАМОГРАНИТ

* GRES PORCELÁNICO · PORCELAIN STONEWARE · GRÈS PORCELAINÉ · КЕРАМОГРАНИТ



R9 R11 C- 1 C- 3 CLASE C Alb <1,5% Bla <0,5% V1



FORMATOS · SIZES · FORMATS · ФОРМАТЫ

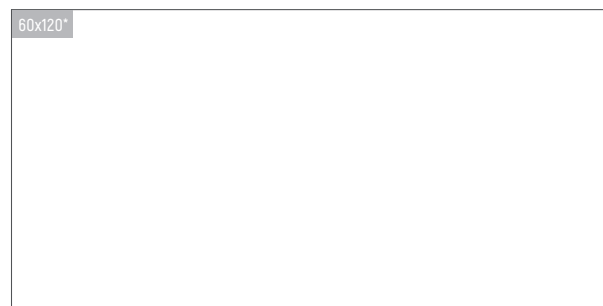

60x120* 60 x 120 cm - 23.7"x 47.2"	14,5x120* 14,5 x 120 cm - 5.7"x 47.2"	33x66,5 33 x 66,5 cm - 13.0"x 26.2"
✂ 10,2 mm ✂ rectificado. rectified	✂ 10,2 mm ✂ rectificado. rectified	✂ 10 mm
✂ C-1	✂ C-1	✂ C-1/C-3

* GRES PORCELÁNICO · PORCELAIN STONEWARE · GRÈS PORCELAINÉ · КЕРАМОГРАНИТ

PIEZAS ESPECIALES · SPECIAL PIECES · PIÈCES SPÉCIALES · СПЕЦИАЛЬНЫЕ ЭЛЕМЕНТЫ



PELDAÑO RECTO 120
33 x 120 x 3 cm - 13.0"x 47.2"x1.2"

✂ 12 mm
 rectificado, rectified
 C-3



PELDAÑO FIORENTINO 120
33 x 120 x 3 cm - 13.0"x 47.2"x1.2"

✂ 12 mm
 rectificado, rectified
 C-1

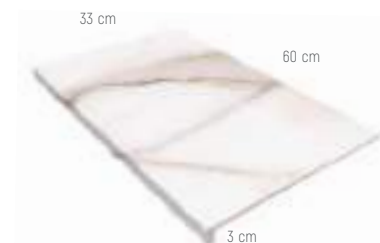

PELDAÑO RECTO 60
33 x 60 x 3 cm - 13.0"x 23.7"x1.2"

✂ 12 mm
 rectificado, rectified
 C-3



REMATE PELDAÑO RECTO
3 x 33 cm - 1.2"x 13.0"



REMATE PELDAÑO FIORENTINO DCHA/IZDA
3 x 33 cm - 1.2"x 13.0"



ZANQUÍN RECTO DCHA/IZDA
40 x 18 cm - 15.7"x 7.1"

✂ 15 mm



ZANQUÍN FIORENTINO DCHA/IZDA
40 x 18 cm - 15.7"x 7.1"

✂ 15 mm



RODAPIÉ
9 x 40 cm - 3.5"x 15.7"

✂ 15 mm



MEDIA CAÑA
33 x 4 cm - 13.0"x 1.6"
r-3 cm



UÑA
4 x 4 cm - 1.6"x 1.6"



ARISTA
33 x 3 cm - 13.0"x 1.2"
r-3 cm



UÑA ARISTA
3 x 3 cm - 1.2"x 1.2"

MARBLES / CALACATTA

OUTOOR: MARBLES CALACATTA 33x66,5 CM (C-3) - PELDAÑO RECTO 33x60x3 CM (C-3)

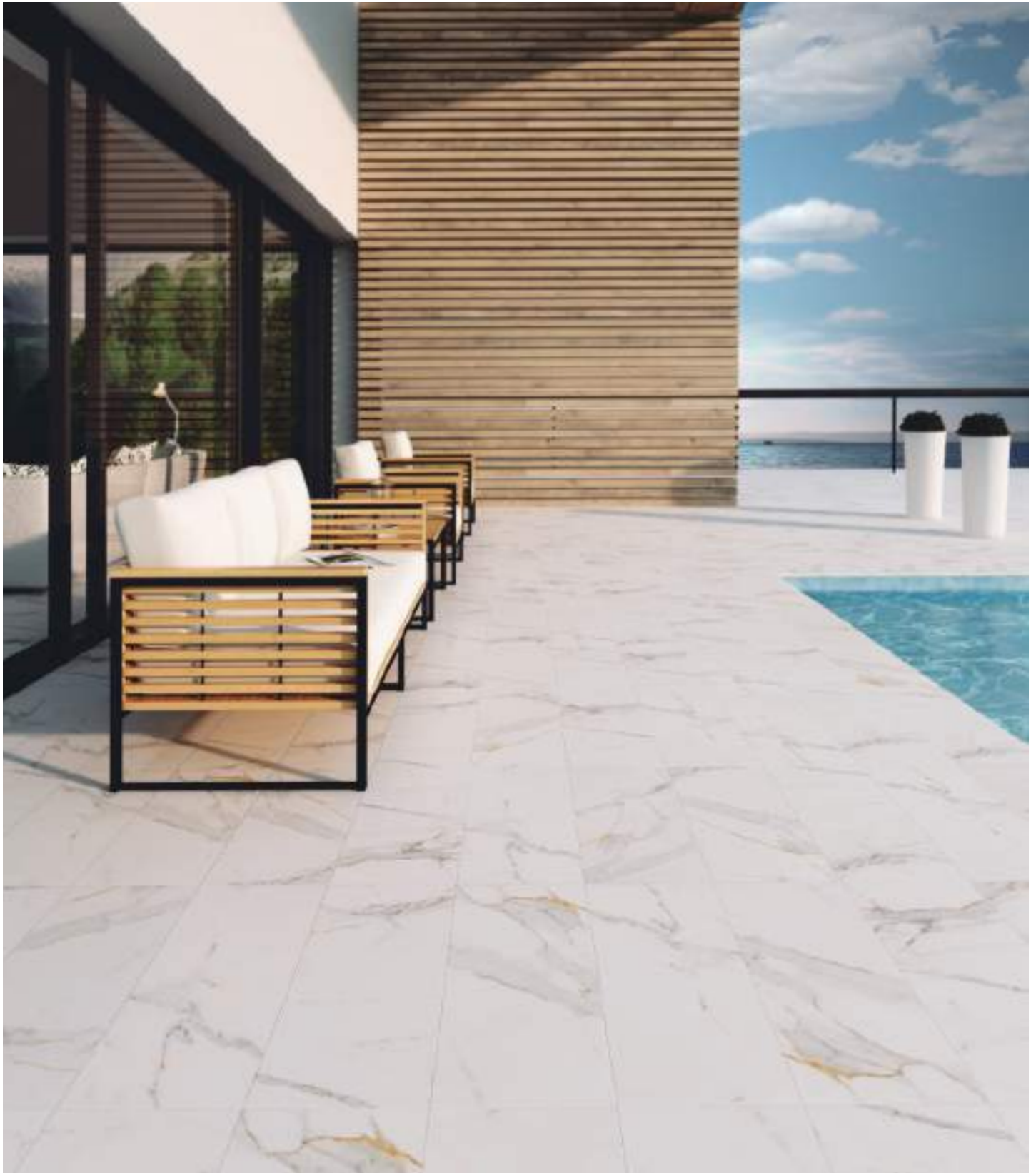

OUTOOR: MARBLES CALACATTA 33x66,5 CM (C-3) - PELDAÑO RECTO 33x60x3 CM (C-3) - MEDIA CAÑA 33x4 CM - UÑA 4x4 CM



MARBLES / TRAVERTINO

GRES EXTRUIDO · EXTRUDED KLINKER · GRÈS EXTRUDÉ · ЭКСТРУДИРОВАННЫЙ КЕРАМОГРАНИТ

* GRES PORCELÁNICO · PORCELAIN STONEWARE · GRÈS PORCELAINÉ · КЕРАМОГРАНИТ



R9 C- 1 Alb <1,5% V1
R11 C- 3 CLASE C Bla <0,5%



FORMATOS · SIZES · FORMATS · ФОРМАТЫ

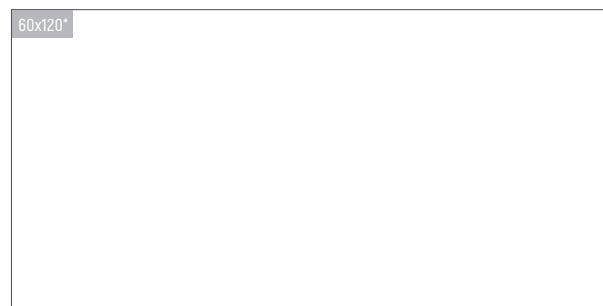

60x120* 60 x 120 cm - 23.7"x 47.2"	14,5x120* 14,5 x 120 cm - 5.7"x 47.2"	33x66,5 33 x 66,5 cm - 13.0"x 26.2"
✂ 10,2 mm ✂ rectificado. rectified	✂ 10,2 mm ✂ rectificado. rectified	✂ 10 mm
✂ C-1	✂ C-1	✂ C-1/C-3

* GRES PORCELÁNICO · PORCELAIN STONEWARE · GRÈS PORCELAINÉ · КЕРАМОГРАНИТ

PIEZAS ESPECIALES · SPECIAL PIECES · PIÈCES SPÉCIALES · СПЕЦИАЛЬНЫЕ ЭЛЕМЕНТЫ



PELDAÑO RECTO 120
33 x 120 x 3 cm - 13.0"x 47.2"x1.2"

✂ 12 mm
 rectificado, rectified
 C-3



PELDAÑO FIORENTINO 120
33 x 120 x 3 cm - 13.0"x 47.2"x1.2"

✂ 12 mm
 rectificado, rectified
 C-1



PELDAÑO RECTO 60
33 x 60 x 3 cm - 13.0"x 23.7"x1.2"

✂ 12 mm
 rectificado, rectified
 C-3



REMATE PELDAÑO RECTO
3 x 33 cm - 1.2"x 13.0"



REMATE PELDAÑO FIORENTINO DCHA/IZDA
3 x 33 cm - 1.2"x 13.0"



ZANQUÍN RECTO DCHA/IZDA
40 x 18 cm - 15.7"x 7.1"

✂ 15 mm



ZANQUÍN FIORENTINO DCHA/IZDA
40 x 18 cm - 15.7"x 7.1"

✂ 15 mm



RODAPIÉ
9 x 40 cm - 3.5"x 15.7"

✂ 15 mm



MEDIA CAÑA
33 x 4 cm - 13.0"x 1.6"
r-3 cm



UÑA
4 x 4 cm - 1.6"x 1.6"
r-3 cm



ARISTA
33 x 3 cm - 13.0"x 1.2"
r-3 cm



UÑA ARISTA
3 x 3 cm - 1.2"x 1.2"

MARBLES / CREMA MARFIL

GRES EXTRUIDO · EXTRUDED KLINKER · GRÈS EXTRUDÉ · ЭКСТРУДИРОВАННЫЙ КЕРАМОГРАНИТ

* GRES PORCELÁNICO · PORCELAIN STONEWARE · GRÈS PORCELAINÉ · КЕРАМОГРАНИТ



R9 C- 1 Alb <1,5% V1
R11 C- 3 CLASE C Bla <0,5%



FORMATOS · SIZES · FORMATS · ФОРМАТЫ

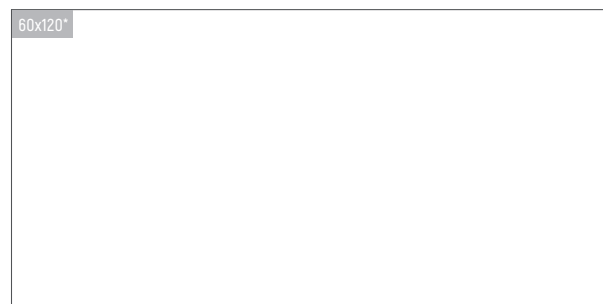
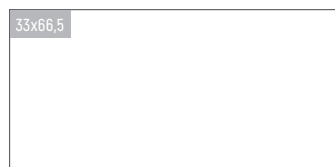

60x120* 60 x 120 cm - 23.7"x 47.2" ✂ 10,2 mm ✂ rectificado. rectified ✂ C-1	14,5x120* 14,5 x 120 cm - 5.7"x 47.2" ✂ 10,2 mm ✂ rectificado. rectified ✂ C-1	33x66,5 33 x 66,5 cm - 13.0"x 26.2" ✂ 10 mm ✂ C-1/C-3
------------------------------------------------------------------------------------------------	---------------------------------------------------------------------------------------------------	-----------------------------------------------------------------------

* GRES PORCELÁNICO · PORCELAIN STONEWARE · GRÈS PORCELAINÉ · КЕРАМОГРАНИТ

PIEZAS ESPECIALES · SPECIAL PIECES · PIÈCES SPÉCIALES · СПЕЦИАЛЬНЫЕ ЭЛЕМЕНТЫ



PELDAÑO RECTO 120
33 x 120 x 3 cm - 13.0"x 47.2"x1.2"

✂ 12 mm
 rectificado, rectified
 C-3



PELDAÑO FIORENTINO 120
33 x 120 x 3 cm - 13.0"x 47.2"x1.2"

✂ 12 mm
 rectificado, rectified
 C-1



PELDAÑO RECTO 60
33 x 60 x 3 cm - 13.0"x 23.7"x1.2"

✂ 12 mm
 rectificado, rectified
 C-3



REMATE PELDAÑO RECTO
3 x 33 cm - 1.2"x 13.0"



REMATE PELDAÑO FIORENTINO DCHA/IZDA
3 x 33 cm - 1.2"x 13.0"



ZANQUÍN RECTO DCHA/IZDA
40 x 18 cm - 15.7"x 7.1"

✂ 15 mm



ZANQUÍN FIORENTINO DCHA/IZDA
40 x 18 cm - 15.7"x 7.1"

✂ 15 mm



RODAPIÉ
9 x 40 cm - 3.5"x 15.7"

✂ 15 mm



MEDIA CAÑA
33 x 4 cm - 13.0"x 1.6"
r-3 cm



UÑA
4 x 4 cm - 1.6"x 1.6"



ARISTA
33 x 3 cm - 13.0"x 1.2"
r-3 cm



UÑA ARISTA
3 x 3 cm - 1.2"x 1.2"

MARBLES / TRAVERTINO

OUTDOOR: TRAVERTINO 33x66,5 CM (C-3) - PELDAÑO RECTO 33x120x3 CM (C-3) / 33x60x3 CM (C-3) - TABICA 14,5x120 CM - MEDIA CAÑA 33x4 CM

FAÇADE: TRAVERTINO 33x66,5 CM (C-1)



MARBLES / CREMA MARFIL



INDOOR: CREMA MARFIL 60x120 CM (C-1) - PELDAÑO RECTO 33x120x3 CM (C-3) - TABICA 14,5x120 CM



WOOD

YOHO

NATURAL WOOD ESSENCE
IN&OUTDOOR
STAIRS
SWIMMINGPOOLS



COLORS:

NATURAL
MAPLE
OAK
TECA

SIZES (cm):

25x150 cm
14,5x120 cm
16,25x66,5 cm

SIZES (inches):

9.8"x59.0"
5.7"x47.2"
6.4"x26.2"



INDOOR: YOHO NATURAL 25x150 CM [C-1]

OUTDOOR: YOHO NATURAL 16,25x66,5 CM [C-3] - BORDE PISCINA SKIMMER 45x75x3 cm [C-3]

YOHŌ / NATURAL

GRES EXTRUIDO · EXTRUDED KLINKER · GRÈS EXTRUDÉ · ЭКСТРУДИРОВАННЫЙ КЕРАМОГРАНИТ

* GRES PORCELÁNICO · PORCELAIN STONEWARE · GRÈS PORCELAINÉ · КЕРАМОГРАНИТ



R9
R11

C- 1
C- 3 CLASE C

Alb <1,5%
Bla <0,5%

V1



FORMATOS · SIZES · FORMATS · ФОРМАТЫ



25x150*
25 x 150 cm - 9.8"x 59.0"
x 11 mm
rectificado, rectified
C-1/C-3



14,5x120*
14,5 x 120 cm - 5.7"x 47.2"
x 10,2 mm
rectificado, rectified
C-1



16,25x66,5
16,25 x 66,5 cm - 6.4"x 26.2"
x 10 mm
C-3

* GRES PORCELÁNICO · PORCELAIN STONEWARE · GRÈS PORCELAINÉ · КЕРАМОГРАНИТ

PIEZAS ESPECIALES · SPECIAL PIECES · PIÈCES SPÉCIALES · СПЕЦИАЛЬНЫЕ ЭЛЕМЕНТЫ



PELDAÑO RECTO 120
33 x 120 x 3 cm - 13.0"x 47.2"x1.2"

- ✕ 12 mm
- ☑ rectificado. rectified
- ☑ C-1/C-3



REMATE PELDAÑO RECTO
3 x 33 cm - 1.2"x 13.0"



ZANQUÍN RECTO DCHA/IZDA
42,3 x 17,5 cm - 16.7"x 7.0"



RODAPIÉ
9 x 60 cm - 3.6"x 23.6"



BORDE PISCINA SKIMMER
45 x 75 x 3 cm - 17.7"x 29.5"x1.2"

- ☑ rectificado. rectified
- ☑ C-3
- ☑ XXXXX. XXXXXX



D. Continuidad gráfica, parte trasera.
Graphic continuous, backside.

YOHO / NATURAL

OUTDOOR: YOHO NATURAL 25x150 CM [C-3] - BORDE PISCINA SKIMMER 45x75x3 CM [C-3]





YONO / MAPLE

GRES EXTRUIDO · EXTRUDED KLINKER · GRÈS EXTRUDÉ · ЭКСТРУДИРОВАННЫЙ КЕРАМОГРАНИТ

* GRES PORCELÁNICO · PORCELAIN STONEWARE · GRÈS PORCELAINÉ · КЕРАМОГРАНИТ



R9 C- 1 Alb <1,5% V1
R11 C- 3 CLASE C Bla <0,5%



FORMATOS · SIZES · FORMATS · ФОРМАТЫ



25x150*
25 x 150 cm - 9.8"x 59.0"

■ 11 mm
■ rectificado, rectified
■ C-1/C-3



14,5x120*
14,5 x 120 cm - 5.7"x 47.2"

■ 10,2 mm
■ rectificado, rectified
■ C-1



16,25x66,5
16,25 x 66,5 cm - 6.4"x 26.2"

■ 10 mm
■ C-3

* GRES PORCELÁNICO · PORCELAIN STONEWARE · GRÈS PORCELAINÉ · КЕРАМОГРАНИТ

PIEZAS ESPECIALES · SPECIAL PIECES · PIÈCES SPÉCIALES · СПЕЦИАЛЬНЫЕ ЭЛЕМЕНТЫ



PELDAÑO RECTO 120
33 x 120 x 3 cm - 13.0"x 47.2"x1.2"

- ✕ 12 mm
- 📐 rectificado. rectified
- 🔲 C-1/C-3



REMATE PELDAÑO RECTO
3 x 33 cm - 1.2"x 13.0"



ZANQUÍN RECTO DCHA/IZDA
42,3 x 17,5 cm - 16.7"x 7.0"



RODAPIÉ
9 x 60 cm - 3.6"x 23.6"



BORDE PISCINA SKIMMER
45 x 75 x 3 cm - 17.7"x 29.5"x1.2"

- 📐 rectificado. rectified
- 🔲 C-3



D. Continuidad gráfica, parte trasera.
Graphic continuous, backside.

YOHO / MAPLE

INDOOR: YOHO MAPLE 25x150 CM (C-1) / 14,5x120 CM (C-1) - PELDAÑO RECTO 33x120x3 CM (C-1)



OUTDOOR: YOHO MAPLE 16,25x66,5 CM (C-3)



YONO / OAK

GRES EXTRUIDO · EXTRUDED KLINKER · GRÈS EXTRUDÉ · ЭКСТРУДИРОВАННЫЙ КЕРАМОГРАНИТ
 * GRES PORCELÁNICO · PORCELAIN STONEWARE · GRÈS PORCELAINÉ · КЕРАМОГРАНИТ



R9 R11 C-1 C-3 CLASE C Alb <1,5% Bla <0,5% V1



FORMATOS · SIZES · FORMATS · ФОРМАТЫ



25x150*
 25 x 150 cm - 9.8"x 59.0"
 x 11 mm
 rectificado. rectified
 C-1/C-3



14,5x120*
 14,5 x 120 cm - 5.7"x 47.2"
 x 10,2 mm
 rectificado. rectified
 C-1



16,25x66,5
 16,25 x 66,5 cm - 6.4"x 26.2"
 x 10 mm
 C-3

* GRES PORCELÁNICO · PORCELAIN STONEWARE · GRÈS PORCELAINÉ · КЕРАМОГРАНИТ

PIEZAS ESPECIALES · SPECIAL PIECES · PIÈCES SPÉCIALES · СПЕЦИАЛЬНЫЕ ЭЛЕМЕНТЫ



PELDAÑO RECTO 120
33 x 120 x 3 cm - 13.0"x 47.2"x 1.2"

- ✂ 12 mm
- 🔲 rectificado. rectified
- 🔲 C-1/C-3



REMATE PELDAÑO RECTO
3 x 33 cm - 1.2"x 13.0"



ZANQUÍN RECTO DCHA/IZDA
42,3 x 17,5 cm - 16.7"x 7.0"



RODAPIÉ
9 x 60 cm - 3.6"x 23.6"



BORDE PISCINA SKIMMER
45 x 75 x 3 cm - 17.7"x 29.5"x 1.2"

- 🔲 rectificado. rectified
- 🔲 C-3

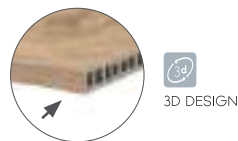

D. Continuidad gráfica, parte trasera.
Graphic continuous, backside.

YOHO / OAK

OUTDOOR: YOHO OAK 25x150 CM (C-3) / 14,5x120 CM (C-1) - PELDAÑO RECTO 33x120x3 CM (C-3) - BORDE PISCINA SKIMMER 45x75x3 CM (C-3)





YOHŌ / TECA

GRES EXTRUIDO · EXTRUDED KLINKER · GRÈS EXTRUDÉ · ЭКСТРУДИРОВАННЫЙ КЕРАМОГРАНИТ
 * GRES PORCELÁNICO · PORCELAIN STONEWARE · GRÈS PORCELAINÉ · КЕРАМОГРАНИТ



R9 R11 C- 1 C- 3 CLASE C Alb <1,5% Bla <0,5% V1



FORMATOS · SIZES · FORMATS · ФОРМАТЫ



25x150*
25 x 150 cm - 9.8"x 59.0"

✕ 11 mm
 rectificado, rectified
 C-1/C-3



14,5x120*
14,5 x 120 cm - 5.7"x 47.2"

✕ 10,2 mm
 rectificado, rectified
 C-1



16,25x66,5
16,25 x 66,5 cm - 6.4"x 26.2"

✕ 10 mm
 C-3

* GRES PORCELÁNICO · PORCELAIN STONEWARE · GRÈS PORCELAINÉ · КЕРАМОГРАНИТ

PIEZAS ESPECIALES · SPECIAL PIECES · PIÈCES SPÉCIALES · СПЕЦИАЛЬНЫЕ ЭЛЕМЕНТЫ



PELDAÑO RECTO 120
33 x 120 x 3 cm - 13.0"x 47.2"x1.2"

- ✕ 12 mm
- ☑ rectificado. rectified
- ☑ C-1/C-3



REMATE PELDAÑO RECTO
3 x 33 cm - 1.2"x 13.0"



ZANQUÍN RECTO DCHA/IZDA
42,3 x 17,5 cm - 16.7"x 7.0"



RODAPIÉ
9 x 60 cm - 3.6"x 23.6"



BORDE PISCINA SKIMMER
45 x 75 x 3 cm - 17.7"x 29.5"x1.2"

- ☑ rectificado. rectified
- ☑ C-3



D. Continuidad gráfica, parte trasera.
Graphic continuous, backside.

YOHO / TECA

OUTOOR: YOHO TECA 25x150 CM (C-3) / 16,25x66,5 CM (C-3) - MARKINA BIANCO 60x120 CM (C-1)





WOOD

KIOTO

ORIENTAL WOOD INSPIRED
LARGE FORMAT
STAIRS



COLORS:

NOGAL
ROBLE
WENGUÉ

SIZES (cm):

20x120 cm
14,5x120 cm

SIZES (inches):

7.9"x47.2"
5.7"x47.2"

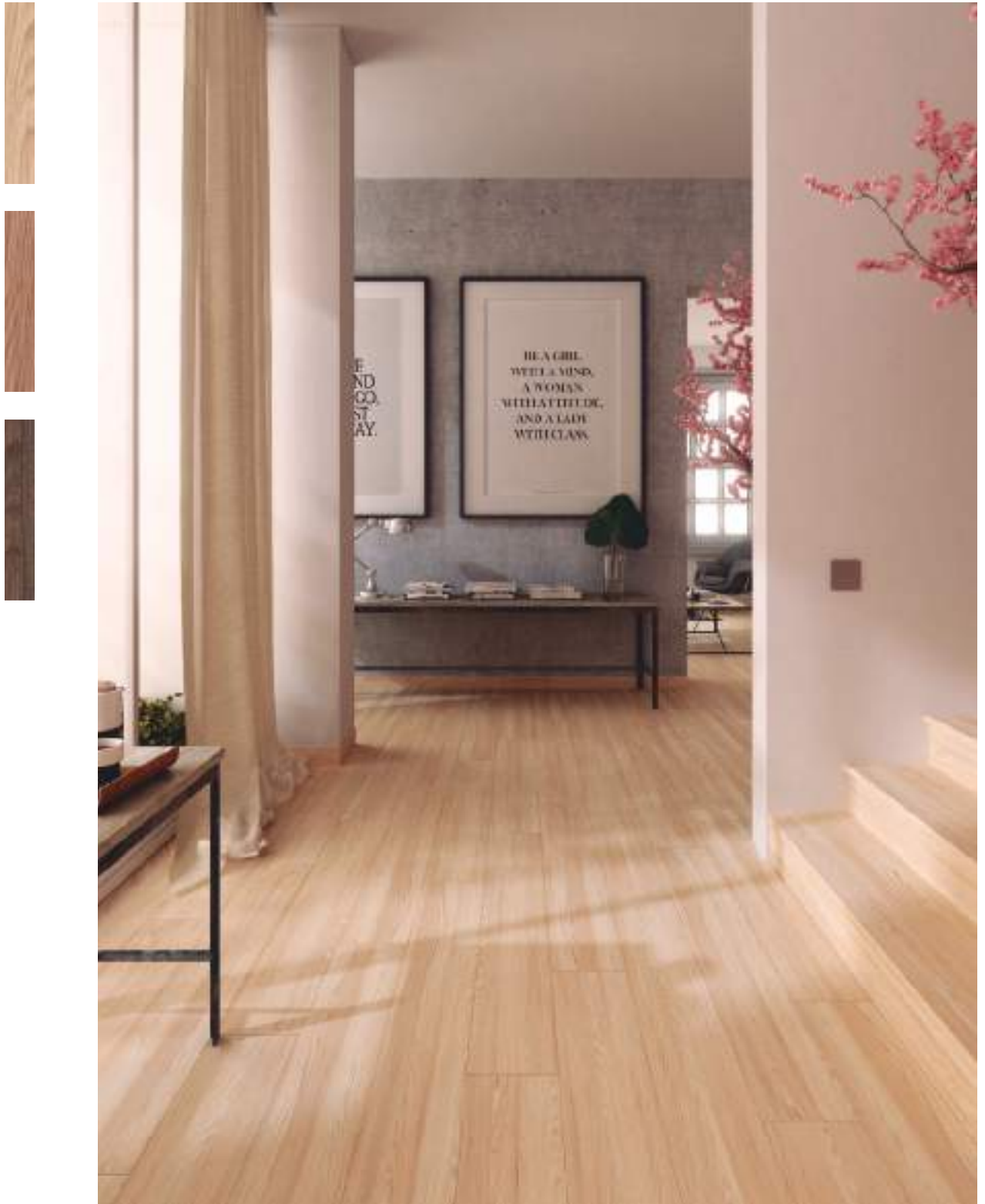

KIOTO NOGAL 20x120 CM [C-1] - TABICA 14,5x120 CM [C-1] - PELDAÑO RECTO 33x120x3 CM [C-1] - RODAPIÉ 9x60 CM

KIOTO /

GRES EXTRUIDO · EXTRUDED KLINKER · GRÈS EXTRUDÉ · ЭКСТРУДИРОВАННЫЙ КЕРАМОГРАНИТ
* GRES PORCELÁNICO · PORCELAIN STONEWARE · GRÈS PORCELAINÉ · КЕРАМОГРАНИТ



R10 C-1 Alb <1,5% Bla <0,5%

V1

NOGAL

ROBLE

WENGUÉ

FORMATOS · SIZES · FORMATS · ФОРМАТЫ

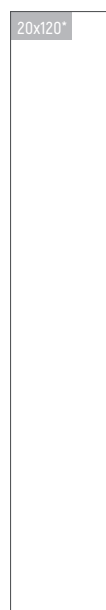

20x120*
20 x 120 cm - 7.9"x 47.2"

✂ 10,2 mm
📏 rectificado, rectified
🔲 C-1



14,5x120*
14,5 x 120 cm - 5.7"x 47.2"

✂ 10,2 mm
📏 rectificado, rectified
🔲 C-1

* GRES PORCELÁNICO · PORCELAIN STONEWARE · GRÈS PORCELAINÉ · КЕРАМОГРАНИТ

PIEZAS ESPECIALES · SPECIAL PIECES · PIÈCES SPÉCIALES · СПЕЦИАЛЬНЫЕ ЭЛЕМЕНТЫ



PELDAÑO FIORENTINO 120
33 x 120 x 3 cm - 13.0"x 47.2" x 1.2"

✂ 12 mm
 rectificado, rectified
 C-1



PELDAÑO RECTO 120
33 x 120 x 3 cm - 13.0"x 47.2" x 1.2"

✂ 12 mm
 rectificado, rectified
 C-1



REMATE PELDAÑO FIORENTINO DCHA/IZDA
3 x 33 cm - 1.2"x 13.0"



REMATE PELDAÑO RECTO
3 x 33 cm - 1.2"x 13.0"



ZANQUÍN FIORENTINO DCHA/IZDA
39,5 x 17,5 cm - 15.8"x 7.0"



ZANQUÍN RECTO DCHA/IZDA
42,3 x 17,5 cm - 16.7"x 7.0"



RODAPIÉ
9 x 60 cm - 3.6"x 23.6"

KIOTO / NOGAL

INDOOR: KIOTO NOGAL 20x120 CM (C-1) - TABICA 14,5x120 CM (C-1) - PELDAÑO RECTO 33x120x3 CM - REMATE PELDAÑO RECTO 3x33 CM - ZANQUÍN RECTO 42,3x17,5 CM

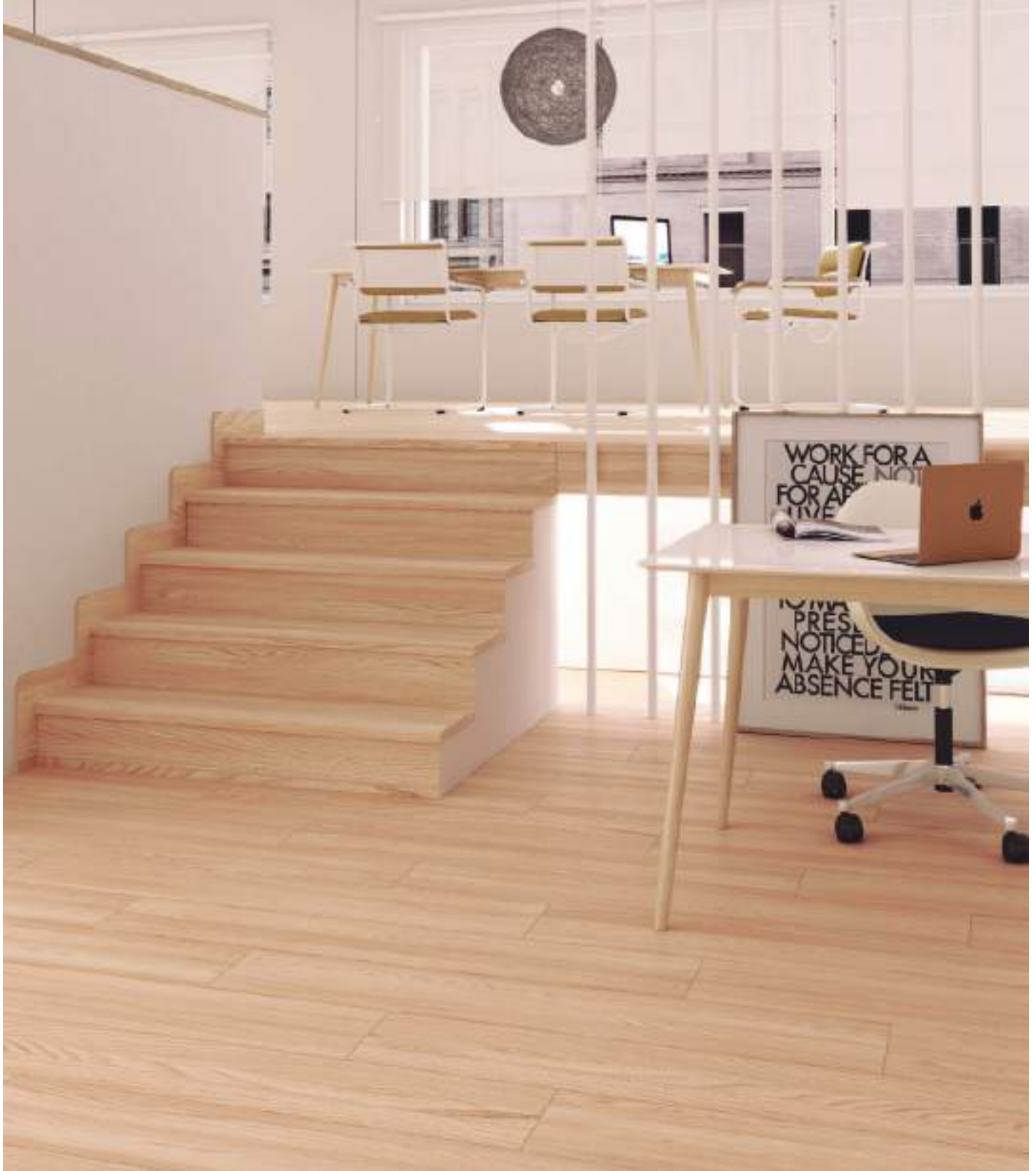

INDOOR: KIOTO ROBLE 20x120 CM (C-1) - TABICA 14,5x120 CM (C-1) - PELDAÑO FIORENTINO 33x120x3 CM - REMATE PELDAÑO FIORENTINO 3x33 CM - ZANQUÍN FIORENTINO DCHA 39,5x17,5 CM



WOOD

NATURA

ANTISLIP WOOD TEXTURE
OUTDOOR
STAIRS
SWIMMINGPOOLS



COLORS:

KENIA
ETNA
CRETA

SIZES (cm):

16,25x66,5 cm

SIZES (inches):

6.4"x26.2"

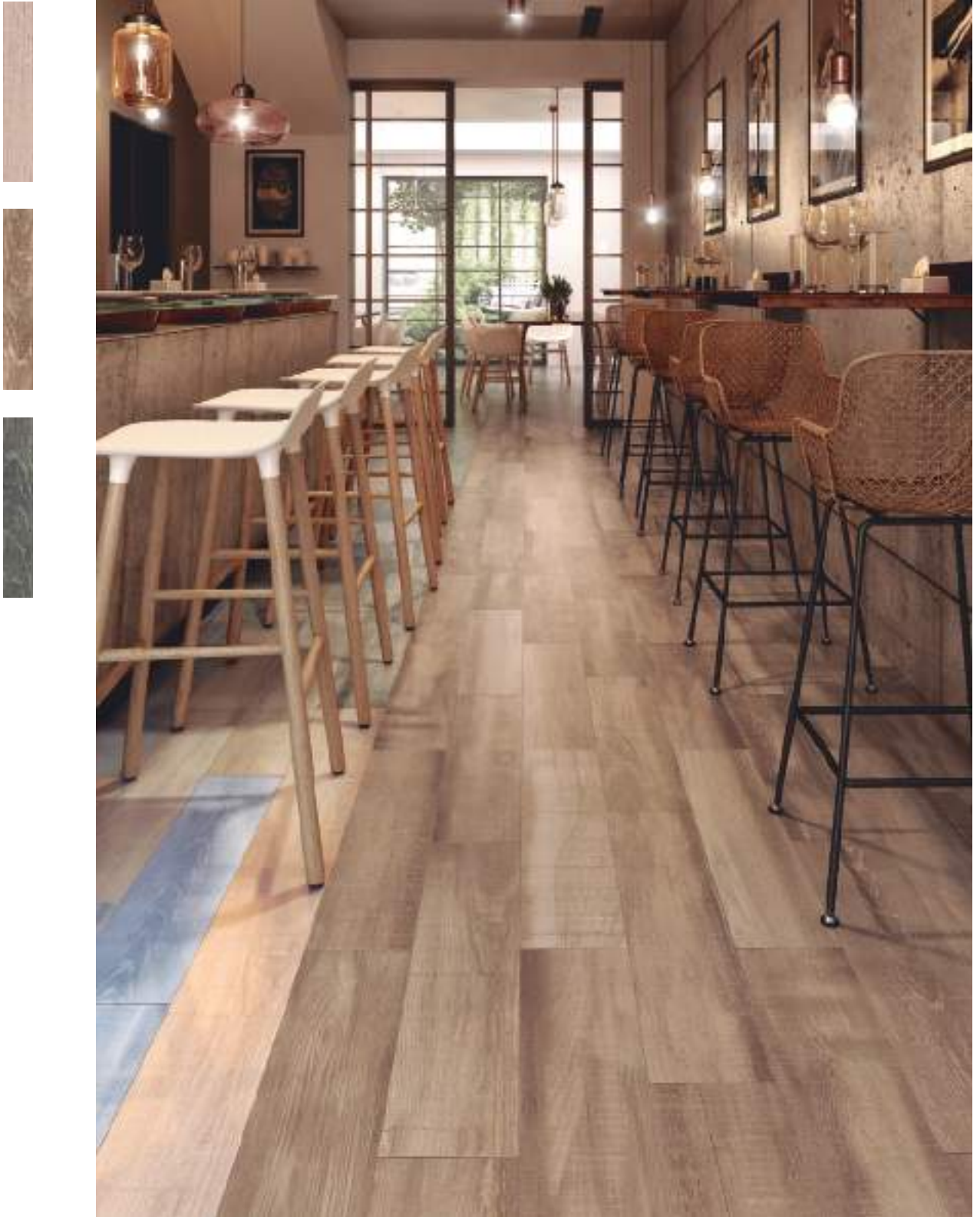

NATURA ETNA 16,25x66,5 CM - CHROMATIC 16,25x66,5 CM

NATURA /

GRES EXTRUIDO · EXTRUDED KLINKER · GRÈS EXTRUDÉ · ЭКСТРУДИРОВАННЫЙ КЕРАМОГРАНИТ

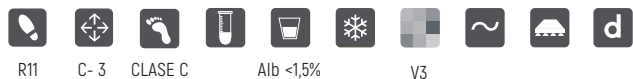

KENIA

ETNA

CRETA



FORMATOS · SIZES · FORMATS · ФОРМАТЫ

16,25x66,5



16,25x66,5
16,25 x 66,5 cm - 6.4"x 26.2"

± 10 mm

DECORADOS · DECORS · FORMATS · ФОРМАТЫ



NOTE KENIA*
16,25 x 66,5 cm - 6.4"x 26.2"

✂ 10 mm *1 set 3 piezas - 3 pieces pack



CHROMATIC*
16,25 x 66,5 cm - 6.4"x 26.2"

✂ 10 mm *1 set 6 piezas - 6 pieces pack

PIEZAS ESPECIALES · SPECIAL PIECES · PIÈCES SPÉCIALES · СПЕЦИАЛЬНЫЕ ЭЛЕМЕНТЫ



PELDAÑO FIORENTINO
33 x 33 x 3 cm - 13.0"x 13.0" x 1.2"

✂ 12 mm



CARTABÓN FIORENTINO DCHA/IZDA.
33 x 33 x 3 cm - 13.0"x 13.0" x 1.2"

✂ 14 mm



ZANQUÍN FIORENTINO DCHA/IZDA
39,5 x 17,5 cm - 15.8"x 7.0"



RODAPIÉ
9 x 33 cm - 3.6"x 13.0"



BORDE PISCINA
28 x 66,5 cm - 11.0"x 26.2"

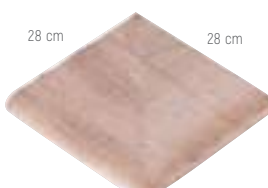

ÁNGULO EXTERIOR PISCINA
28 x 28 cm - 11.0"x 11.0"



ÁNGULO INTERIOR PISCINA
33 x 33 cm - 13.0"x 13.0"

NATURA / KENIA

INDOOR / OUTDOOR: NATURA KENIA 16,25x66,5 CM - PELDAÑO FIORENTINO 33x33x3 CM



/ CRETA



OUTOOR: NATURA CRETA 16,25x66,5 CM - BORDE PISCINA 28x66,5 CM - ÁNGULO INTERIOR PISCINA 33x33 CM



URBAN

ÓPERA

CONCRETE & INDUSTRIAL TREND

IN&OUTDOOR

LARGE FORMATS

STAIRS

SWIMMINGPOOLS



COLORS:

LIGHT

IVORY

SILVER

IRON

SIZES (cm):

120x120 cm

60x120 cm

14,5x120 cm

33x66,5 cm

SIZES (inches):

47.2"x47.2"

23.7"x47.2"

5.7"x47.2"

13.0"x26.2"



ÓPERA IRON 120x120 CM [C-3] - ÓPERA IRON 33x66,5 CM [C-1] / 14,5x120 CM [C-1] - PELDAÑO RECTO 33x120x3 CM [C-3] -BORDE DESBORDANTE 28x66,5 CM [C-3] - ÁNG. DESBORDANTE 33x33 CM [C-3] - REJILLA 24,5x24,5 CM - ANG. REJILLA 24,5x33 CM - MEDIA CAÑA 33x4 CM

ÓPERA / IVORY

GRES EXTRUIDO · EXTRUDED KLINKER · GRÈS EXTRUDÉ · ЭКСТРУДИРОВАННЫЙ КЕРАМОГРАНИТ
* GRES PORCELÁNICO · PORCELAIN STONEWARE · GRÈS PORCELAINÉ · КЕРАМОГРАНИТ



R9 C- 1 Alb <1,5% V3
R12 C- 3 CLASE C Bla <0,5%



FORMATOS · SIZES · FORMATS · ФОРМАТЫ

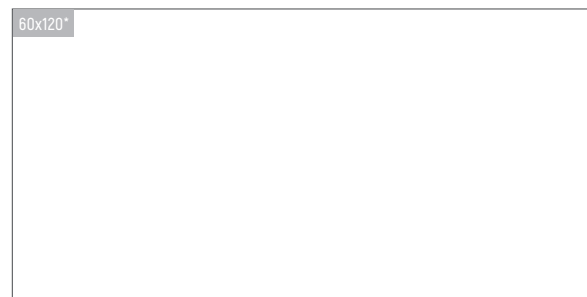
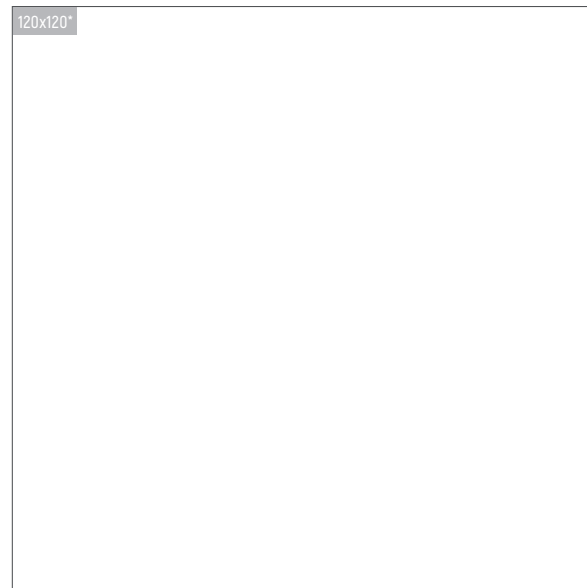

120x120*
120 x 120 cm -
47.2"x 47.2"

✂ 10 mm
☑ rectificado. rectified
☒ C-1/C-3

60x120*
60 x 120 cm -
23.7"x 47.2"

✂ 11,3 mm
☑ rectificado. rectified
☒ C-1/C-3

14,5x120*
14,5 x 120 cm -
5.7"x 47.2"

✂ 11,3 mm
☑ rectificado. rectified
☒ C-1

33x66,5
33 x 66,5 cm -
13.0"x 26.2"

✂ 10 mm
☒ C-1/C-3

PIEZAS ESPECIALES · SPECIAL PIECES · PIÈCES SPÉCIALES · СПЕЦИАЛЬНЫЕ ЭЛЕМЕНТЫ



PELDAÑO RECTO 120
33 x 120 x 3 cm - 13.0"x 47.2"x1.2"

- ✂ 12 mm
- 📐 rectificado. rectified
- 📦 C-1/C-3



REMATE PELDAÑO RECTO
3 x 33 cm - 1.2"x 13.0"



RODAPIÉ
9 x 60 cm - 3.6"x 23.6"



ZANQUÍN RECTO DCHA/IZDA
42,3 x 17,5 cm - 16.7"x 7.0"



BORDE PISCINA SKIMMER
45 x 75 x 3 cm - 17.7"x 29.5"x1.2"

- 📐 rectificado. rectified
- 📦 C-3



D. Continuidad gráfica, parte trasera.
Graphic continuous, backside.



BORDE DESBORDANTE
28 x 66,5 cm - 11.0"x26.2"

- 📐 rectificado. rectified
- 📦 C-3



ÁNGULO DESBORDANTE
33 x 33 cm - 13.0"x13.0"

- 📐 rectificado. rectified
- 📦 C-3



REJILLA
24,5 x 24,5 cm - 9.6"x9.6"

- 📐 rectificado. rectified
- 📦 C-3



ÁNGULO REJILLA DERECHA*
24,5 x 33 cm - 9.6"x13.0"

- 📐 rectificado. rectified
- 📦 C-3



ÁNGULO REJILLA IZQUIERDA*
24,5 x 33 cm - 9.6"x13.0"

- 📐 rectificado. rectified
- 📦 C-3

*set de 2 piezas (dcha./izda.) *two pieces set (right/left)



MEDIA CAÑA
33 x 4 cm - 13.0"x 1.6"
r-3 cm



UÑA
4 x 4 cm - 1.6"x 1.6"



ARISTA
33 x 3 cm - 13.0"x 1.2"
r-3 cm



UÑA ARISTA
3 x 3 cm - 1.2"x 1.2"

ÓPERA / IVORY

INDOOR: ÓPERA IVORY 120x120 CM [C-1]

OUTDOOR: ÓPERA IVORY 60x120 CM [C-3] - ÓPERA IVORY 120x120 CM [C-3] - BORDE DESBORDANTE 28x66,5 CM [C-3] -



REJILLA 24,5x24,5 CM (C-3) - ÁNGULO DESBORDANTE 33x33 CM - ÁNGULO REJILLA IZDA./DCHA. 24,5x33 CM (C-3) - MEDIA CAÑA 33x4 CM - ÓPERA IVORY 33x66,5 CM (C-1)



ÓPERA / LIGHT

GRES EXTRUIDO · EXTRUDED KLINKER · GRÈS EXTRUDÉ · ЭКСТРУДИРОВАННЫЙ КЕРАМОГРАНИТ
 * GRES PORCELÁNICO · PORCELAIN STONEWARE · GRÈS PORCELAINÉ · КЕРАМОГРАНИТ



R9 R12 C- 1 C- 3 CLASE C Alb <1,5% Bla <0,5% V3



FORMATOS · SIZES · FORMATS · ФОРМАТЫ

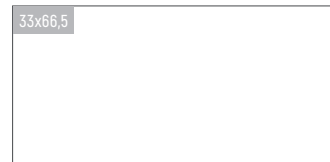
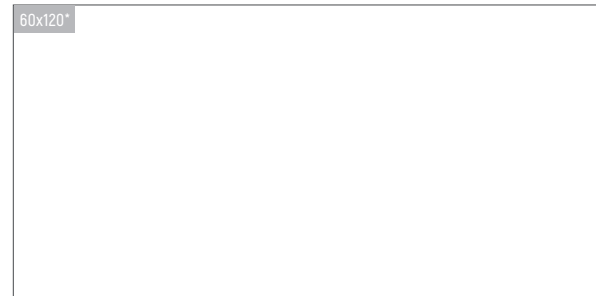
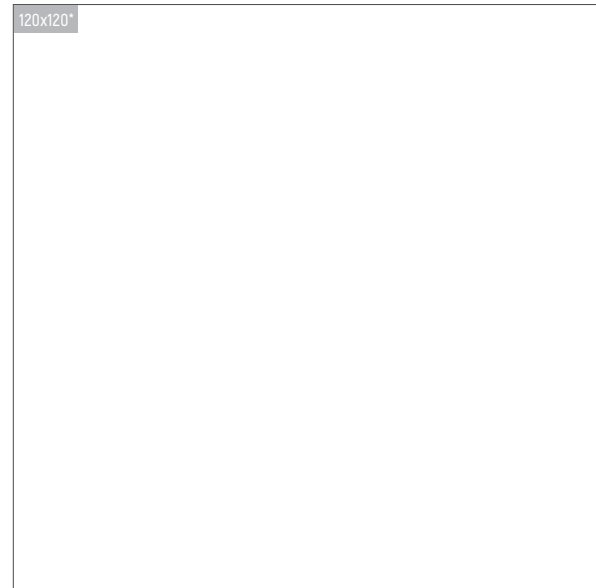

120x120*
120 x 120 cm -
47.2"x 47.2"

✂ 10 mm
 rectificado. rectified
 C-1/C-3

60x120*
60 x 120 cm -
23.7"x 47.2"

✂ 11,3 mm
 rectificado. rectified
 C-1/C-3

14,5x120*
14,5 x 120 cm -
5.7"x 47.2"

✂ 11,3 mm
 rectificado. rectified
 C-1

33x66,5
33 x 66,5 cm -
13.0"x 26.2"

✂ 10 mm
 C-1/C-3

* GRES PORCELÁNICO · PORCELAIN STONEWARE · GRÈS PORCELAINÉ · КЕРАМОГРАНИТ

PIEZAS ESPECIALES · SPECIAL PIECES · PIÈCES SPÉCIALES · СПЕЦИАЛЬНЫЕ ЭЛЕМЕНТЫ



PELDAÑO RECTO 120
33 x 120 x 3 cm - 13.0"x 47.2"x 1.2"

- ✂ 12 mm
- ☑ rectificado. rectified
- ☒ C-1/C-3



REMATE PELDAÑO RECTO
3 x 33 cm - 1.2"x 13.0"



RODAPIÉ
9 x 60 cm - 3.6"x 23.6"



ZANQUÍN RECTO DCHA/IZDA
42,3 x 17,5 cm - 16,7"x 7,0"



BORDE PISCINA SKIMMER
45 x 75 x 3 cm - 17.7"x 29.5"x 1.2"

- ☑ rectificado. rectified
- ☒ C-3



D. Continuidad gráfica, parte trasera.
Graphic continuous, backside.



BORDE DESBORDANTE
28 x 66,5 cm - 11.0"x 26.2"

- ☑ rectificado. rectified
- ☒ C-3



ÁNGULO DESBORDANTE
33 x 33 cm - 13.0"x 13.0"

- ☑ rectificado. rectified
- ☒ C-3



REJILLA
24,5 x 24,5 cm - 9.6"x 9.6"

- ☑ rectificado. rectified
- ☒ C-3



ÁNGULO REJILLA DERECHA*
24,5 x 33 cm - 9.6"x 13.0"

- ☑ rectificado. rectified
- ☒ C-3



ÁNGULO REJILLA IZQUIERDA*
24,5 x 33 cm - 9.6"x 13.0"

- ☑ rectificado. rectified
- ☒ C-3

*set de 2 piezas (dcha./izda.) *two pieces set (right/left)



MEDIA CAÑA
33 x 4 cm - 13.0"x 1.6"
r-3 cm



UÑA
4 x 4 cm - 1.6"x 1.6"



ARISTA
33 x 3 cm - 13.0"x 1.2"
r-3 cm



UÑA ARISTA
3 x 3 cm - 1.2"x 1.2"

ÓPERA / LIGHT

OUTDOOR: ÓPERA LIGHT 60x120 CM (C-3) - PELDAÑO RECTO 33x120x3 CM (C-3) - TABICA 14,5x120 CM (C-1) - BORDE PISCINA SKIMMER 45x75x3 CM (C-3)



INDOOR: ÓPERA LIGHT 60x120 CM (C-1)



ÓPERA / SILVER

GRES EXTRUIDO · EXTRUDED KLINKER · GRÈS EXTRUDÉ · ЭКСТРУДИРОВАННЫЙ КЕРАМОГРАНИТ
 * GRES PORCELÁNICO · PORCELAIN STONEWARE · GRÈS PORCELAINÉ · КЕРАМОГРАНИТ



R9 C- 1 Alb <1,5% V3
 R12 C- 3 CLASE C Bla <0,5%



FORMATOS · SIZES · FORMATS · ФОРМАТЫ

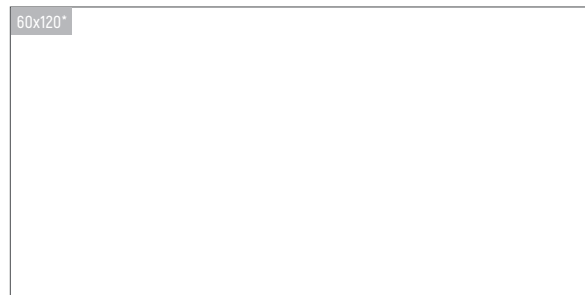
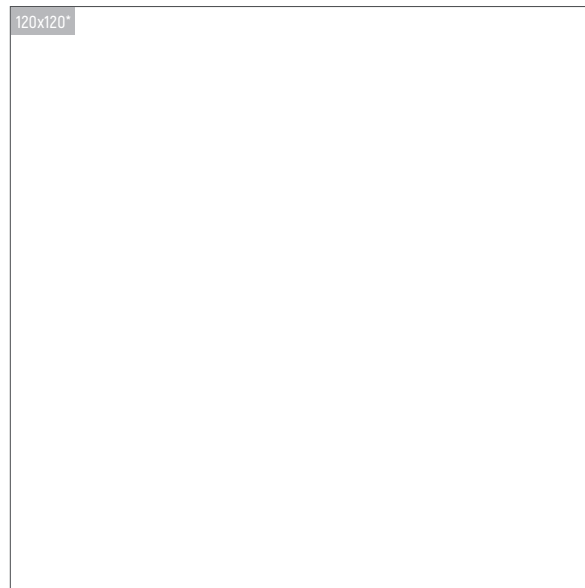

120x120* 120 x 120 cm - 47.2"x 47.2"	60x120* 60 x 120 cm - 23.7"x 47.2"	14,5x120* 14,5 x 120 cm - 5.7"x 47.2"	33x66,5 33 x 66,5 cm - 13.0"x 26.2"
✂ 10 mm 📐 rectificado. rectified 📏 C-1/C-3	✂ 11,3 mm 📐 rectificado. rectified 📏 C-1/C-3	✂ 11,3 mm 📐 rectificado. rectified 📏 C-1	✂ 10 mm 📐 rectificado. rectified 📏 C-1/C-3

* GRES PORCELÁNICO · PORCELAIN STONEWARE · GRÈS PORCELAINÉ · КЕРАМОГРАНИТ

PIEZAS ESPECIALES · SPECIAL PIECES · PIÈCES SPÉCIALES · СПЕЦИАЛЬНЫЕ ЭЛЕМЕНТЫ



PELDAÑO RECTO 120
33 x 120 x 3 cm - 13.0"x 47.2"x 1.2"

- ✕ 12 mm
- ☑ rectificado. rectified
- ☒ C-1/C-3



REMATE PELDAÑO RECTO
3 x 33 cm - 1.2"x 13.0"

RODAPIÉ
9 x 60 cm - 3.6"x 23.6"



ZANQUÍN RECTO DCHA/IZDA
42,3 x 17,5 cm - 16.7"x 7.0"



BORDE PISCINA SKIMMER
45 x 75 x 3 cm - 17.7"x 29.5"x 1.2"

- ☑ rectificado. rectified
- ☒ C-3



D. Continuidad gráfica, parte trasera.
Graphic continuous, backside.



BORDE DESBORDANTE
28 x 66,5 cm - 11.0"x 26.2"

- ☑ rectificado. rectified
- ☒ C-3



ÁNGULO DESBORDANTE
33 x 33 cm - 13.0"x 13.0"

- ☑ rectificado. rectified
- ☒ C-3



REJILLA
24,5 x 24,5 cm - 9.6"x 9.6"

- ☑ rectificado. rectified
- ☒ C-3



ÁNGULO REJILLA DERECHA*
24,5 x 33 cm - 9.6"x 13.0"

- ☑ rectificado. rectified
- ☒ C-3



ÁNGULO REJILLA IZQUIERDA*
24,5 x 33 cm - 9.6"x 13.0"

- ☑ rectificado. rectified
- ☒ C-3

*set de 2 piezas [dcha./izda.] *two pieces set [right/left]



MEDIA CAÑA
33 x 4 cm - 13.0"x 1.6"
r-3 cm



UÑA
4 x 4 cm - 1.6"x 1.6"



ARISTA
33 x 3 cm - 13.0"x 1.2"
r-3 cm



UÑA ARISTA
3 x 3 cm - 1.2"x 1.2"

ÓPERA / SILVER

OUTDOOR: ÓPERA SILVER 60x120 CM (C-3) / 120x120 CM (C-3) - BORDE PISCINA SKIMMER 45x75x3 CM (C-3) - ÓPERA SILVER 33x66,5 CM (C-1) - MEDIA CAÑA 33x4 CM - UÑA 4x4 CM



INDOOR: ÓPERA SILVER 60x120 CM (C-1)



ÓPERA / IRON

GRES EXTRUIDO · EXTRUDED KLINKER · GRÈS EXTRUDÉ · ЭКСТРУДИРОВАННЫЙ КЕРАМОГРАНИТ
* GRES PORCELÁNICO · PORCELAIN STONWARE · GRÈS PORCELAINÉ · КЕРАМОГРАНИТ



R9 R12 C- 1 C- 3 CLASE C Alb <1,5% Bla <0,5% V3



FORMATOS · SIZES · FORMATS · ФОРМАТЫ

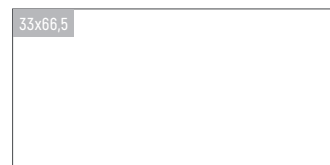
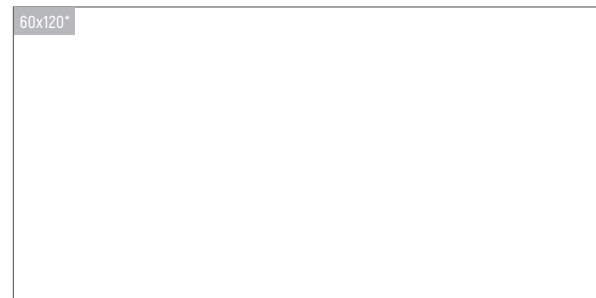
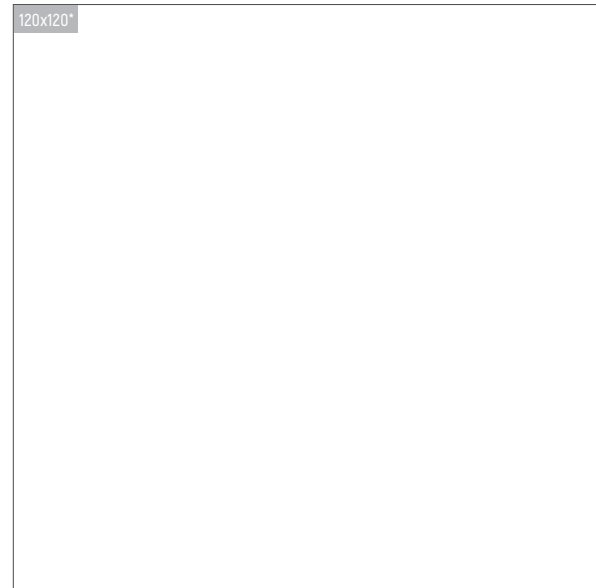

120x120*
120 x 120 cm -
47.2"x 47.2"

✂ 10 mm
✂ rectificado. rectified
✂ C-1/C-3

60x120*
60 x 120 cm -
23.7"x 47.2"

✂ 11,3 mm
✂ rectificado. rectified
✂ C-1/C-3

14,5x120*
14,5 x 120 cm -
5.7"x 47.2"

✂ 11,3 mm
✂ rectificado. rectified
✂ C-1

33x66,5
33 x 66,5 cm -
13.0"x 26.2"

✂ 10 mm
✂ C-1/C-3

* GRES PORCELÁNICO · PORCELAIN STONWARE · GRÈS PORCELAINÉ · КЕРАМОГРАНИТ

PIEZAS ESPECIALES · SPECIAL PIECES · PIÈCES SPÉCIALES · СПЕЦИАЛЬНЫЕ ЭЛЕМЕНТЫ



PELDAÑO RECTO 120
33 x 120 x 3 cm - 13.0"x 47.2"x 1.2"

- ✕ 12 mm
- ☑ rectificado, rectified
- ☒ C-1/C-3



REMATE PELDAÑO RECTO
3 x 33 cm - 1.2"x 13.0"

RODAPIÉ
9 x 60 cm - 3.6"x 23.6"



ZANQUÍN RECTO DCHA/IZDA
42,3 x 17,5 cm - 16.7"x 7.0"



BORDE PISCINA SKIMMER
45 x 75 x 3 cm - 17.7"x 29.5"x 1.2"

- ☑ rectificado, rectified
- ☒ C-3



D. Continuidad gráfica, parte trasera.
Graphic continuous, backside.



BORDE DESBORDANTE
28 x 66,5 cm - 11.0"x 26.2"

- ☑ rectificado, rectified
- ☒ C-3



ÁNGULO DESBORDANTE
33 x 33 cm - 13.0"x 13.0"

- ☑ rectificado, rectified
- ☒ C-3



REJILLA
24,5 x 24,5 cm - 9.6"x 9.6"

- ☑ rectificado, rectified
- ☒ C-3



ÁNGULO REJILLA DERECHA*
24,5 x 33 cm - 9.6"x 13.0"

- ☑ rectificado, rectified
- ☒ C-3



ÁNGULO REJILLA IZQUIERDA*
24,5 x 33 cm - 9.6"x 13.0"

- ☑ rectificado, rectified
- ☒ C-3

*set de 2 piezas [dcha./izda.] *two pieces set [right/left]



MEDIA CAÑA
33 x 4 cm - 13.0"x 1.6"
r-3 cm



UÑA
4 x 4 cm - 1.6"x 1.6"



ARISTA
33 x 3 cm - 13.0"x 1.2"
r-3 cm



UÑA ARISTA
3 x 3 cm - 1.2"x 1.2"

ÓPERA / IRON

OUTDOOR: ÓPERA IRON 120x120 CM (C-3) - PELDAÑO RECTO 33x120x3 CM (C-3) - TABICA 14,5x120 CM - BORDE DESBORDANTE 28x66,5 CM (C-3) - REJILLA 24,5x24,5 cm (C-3)



ÁNG. REJILLA IZDA./DCHA. 24,5x33 CM (C-3) - ÁNG. DESBORDANTE 33x33 CM (C-3) - MEDIA CAÑA 33x4 CM - UÑA 4x4 CM - ÓPERA IRON 33x66,5 CM (C-1) INDOOR: ÓPERA IRON 60x120 CM (C-1)



ÓPERA / IRON

INDOOR: ÓPERA IRON 60x120 CM (C-1)



OUTDOOR: ÓPERA IRON 120x120 CM (C-3) - BORDE PISCINA SKIMMER 45x75x3 CM (C-3)



URBAN

MEDITERRÁNEO

CEMENT SLATE DESIGN
IN&OUTDOOR
STAIRS



COLORS:

SIZES (cm):

SIZES (inches):

ARENA
GRAFITO

33x66,5 cm
33x33 cm

13.0"x26.2"
13.0"x13.0"



PELDAÑO RECTO GRAFITO 33x33x3 cm (C-1) - ZANQUÍN RECTO IZDA. GRAFITO 42,3x17,5 CM

MEDITERRÁNEO /

GRES EXTRUIDO · EXTRUDED KLINKER · GRÈS EXTRUDÉ · ЭКСТРУДИРОВАННЫЙ КЕРАМОГРАНИТ



R9
R11

C-1
C-3

Alb <1,5%

VI

ARENA

GRAFITO

FORMATOS · SIZES · FORMATS · ФОРМАТЫ

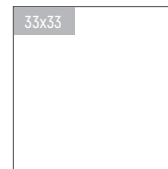

33x66,5

33 x 66,5 cm -
13.0" x 26.2"

⊠ 10 mm
■ C-1 / C-3

33x33

33 x 33 cm -
13.0" x 13.0"

⊠ 10 mm
■ C-1 / C-3

PIEZAS ESPECIALES · SPECIAL PIECES · PIÈCES SPÉCIALES · СПЕЦИАЛЬНЫЕ ЭЛЕМЕНТЫ

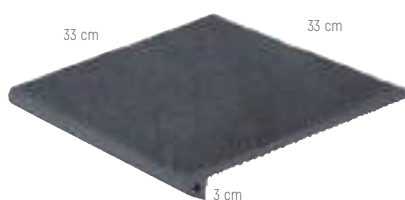

PELDAÑO FIORENTINO
33 x 33 x 3 cm - 13.0"x 13.0"x1.2"

✂ 12 mm
☒ C-1/C-3



CARTABÓN FIORENTINO
33 x 33 x 3 cm - 13.0"x 13.0"x1.2"

✂ 14 mm
☒ C-1/C-3
☑ rectificado, rectified



PELDAÑO RECTO
33 x 33 x 3 cm - 13.0"x 13.0"x1.2"

✂ 12 mm
☒ C-1/C-3



ZANQUIN FIORENTINO IZDA./DCHA.
39,5 x 17,5 cm - 15.8"x 7.0"



ZANQUIN RECTO IZDA./DCHA.
42,3 x 17,5 cm - 16.7"x 7.0"



RODAPIÉ
9 x 33 cm - 3.6"x 13.0"

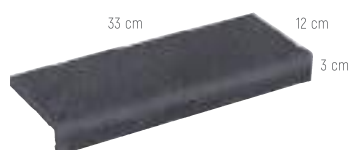

VIERTEAGUAS
12 x 33 x 3 cm - 3.6"x 13.0"x1.2"

✂ 12 mm



PASAMANOS 12*
12,5 x 66,5 x 4 cm - 3.6"x 26.2"x1.6"



PASAMANOS 15*
15,5 x 66,5 x 4 cm - 6.1"x 26.2"x1.6"

*medidas interiores. interior dimensions.

MEDITERRÁNEO / ARENA

OUTDOOR: MEDITERRÁNEO ARENA 33x66,5 CM (C-3) - PELDAÑO RECTO 33x33x3 CM (C-3)





STONE

MILÁN

INSPIRED BY GEOLOGY

IN&OUTDOOR

STAIRS

SWIMMINGPOOLS



COLORS:

ARENA
GRIS
MARENCO

SIZES (cm):

75x75 cm
14,5x120 cm
33x33 cm

SIZES (inches):

29.5"x29.5"
5.7"x47.2"
13.0"x13.0"

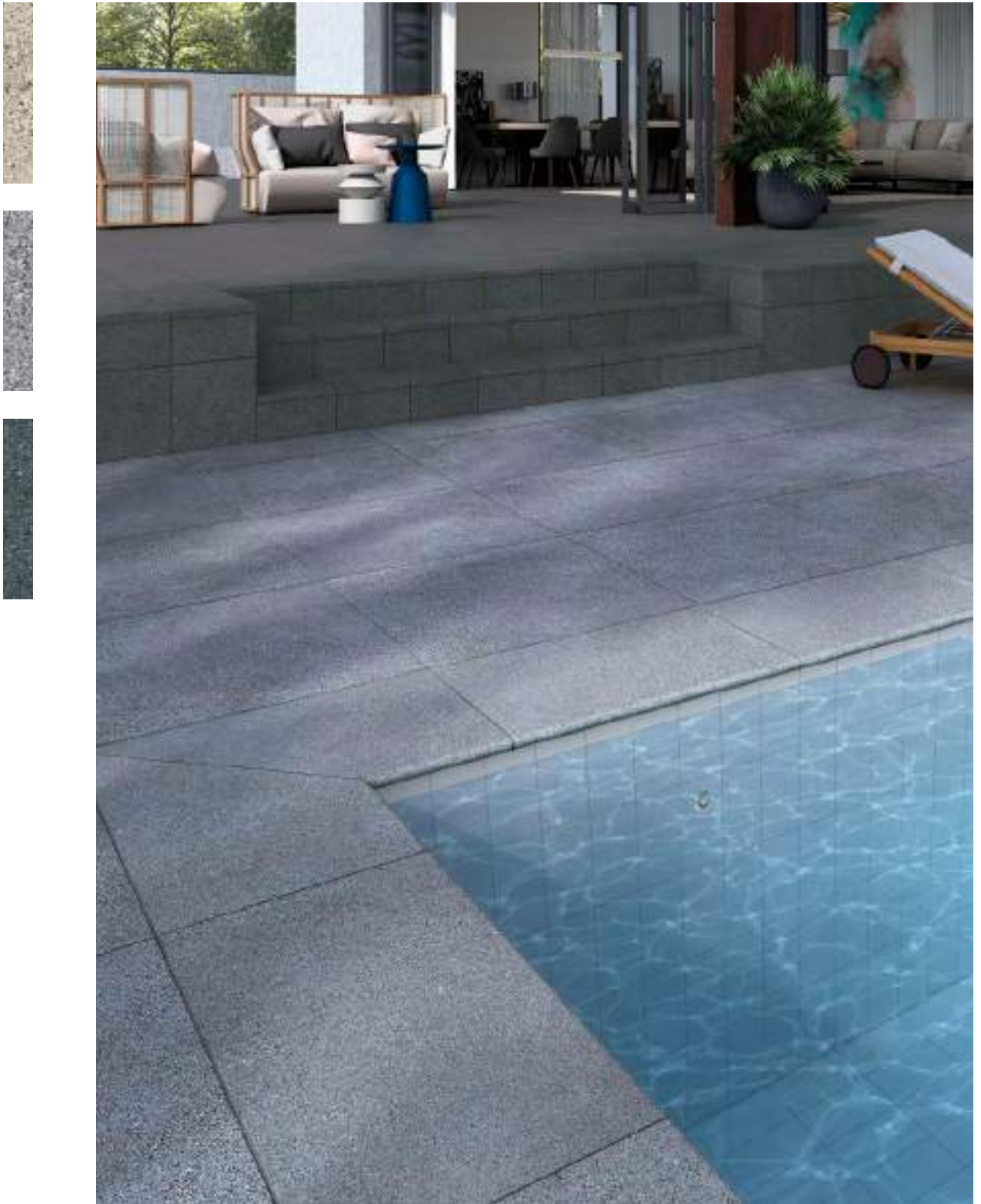

MILÁN GRIS 75x75 CM (C-3) - MILÁN MARENCO 33x33 CM (C-3) - BORDE PISCINA SKIMMER MILÁN GRIS 45x75x3 CM (C-3) - MILÁN MARENCO PELDAÑO RECTO 33x33x3 CM (C-3)

MILÁN / ARENA

GRES EXTRUIDO · EXTRUDED KLINKER · GRÈS EXTRUDÉ · ЭКСТРУДИРОВАННЫЙ КЕРАМОГРАНИТ
* GRES PORCELÁNICO · PORCELAIN STONEWARE · GRÈS PORCELAINÉ · КЕРАМОГРАНИТ



R9 C-1 Alb <1,5% v1
R12 C-3 CLASE C Bla <0,5%



FORMATOS · SIZES · FORMATS · ФОРМАТЫ

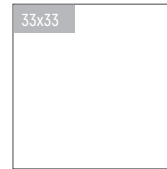

75x75*

75 x 75 cm - 29.5" x 29.5"

± 11 mm

☑ rectificado, rectified

☑ C-1/C-3

14,5x120*

14,5 x 120 cm - 5.7" x 47.2"

± 10,2 mm

☑ rectificado, rectified

☑ C-1

33x33

33 x 33 cm - 13.0" x 13.0"

± 10 mm

☑ C-3

* GRES PORCELÁNICO · PORCELAIN STONEWARE · GRÈS PORCELAINÉ · КЕРАМОГРАНИТ

PIEZAS ESPECIALES · SPECIAL PIECES · PIÈCES SPÉCIALES · СПЕЦИАЛЬНЫЕ ЭЛЕМЕНТЫ



PELDAÑO RECTO 120
33 x 120 x 3 cm - 13.0"x 47.2"x 1.2"

- ✂ 12 mm
- 📐 rectificado, rectified
- 🔧 C-1/ C-3



PELDAÑO RECTO
33 x 33 x 3 cm - 13.0"x 13.0"x 1.2"

- ✂ 12 mm
- 📐 rectificado, rectified
- 🔧 C-3



REMATE PELDAÑO RECTO
3 x 33 cm - 1.2"x 13.0"



RODAPIÉ
9 x 60 cm - 3.6"x 23.6"



ZANQUÍN RECTO DCHA/IZDA
42,3 x 17,5 cm - 16.7"x 7.0"



BORDE PISCINA SKIMMER
45 x 75 x 3 cm - 17.7"x 29.5"x 1.2"

- 📐 rectificado, rectified
- 🔧 C-3



D. Continuidad gráfica, parte trasera.
Graphic continuous, backside.

3D DESIGN

MILÁN / ARENA

OUTDOOR: MILÁN ARENA / GRIS 33x33 CM (C-3)- PELDAÑO RECTO MILÁN ARENA 33x120x3 CM (C-3) - TABICA MILÁN ARENA 14,5x120 CM



INDOOR: MILÁN ARENA 75x75 CM (C-1) - PELDAÑO RECTO 33x120 CM (C-1)

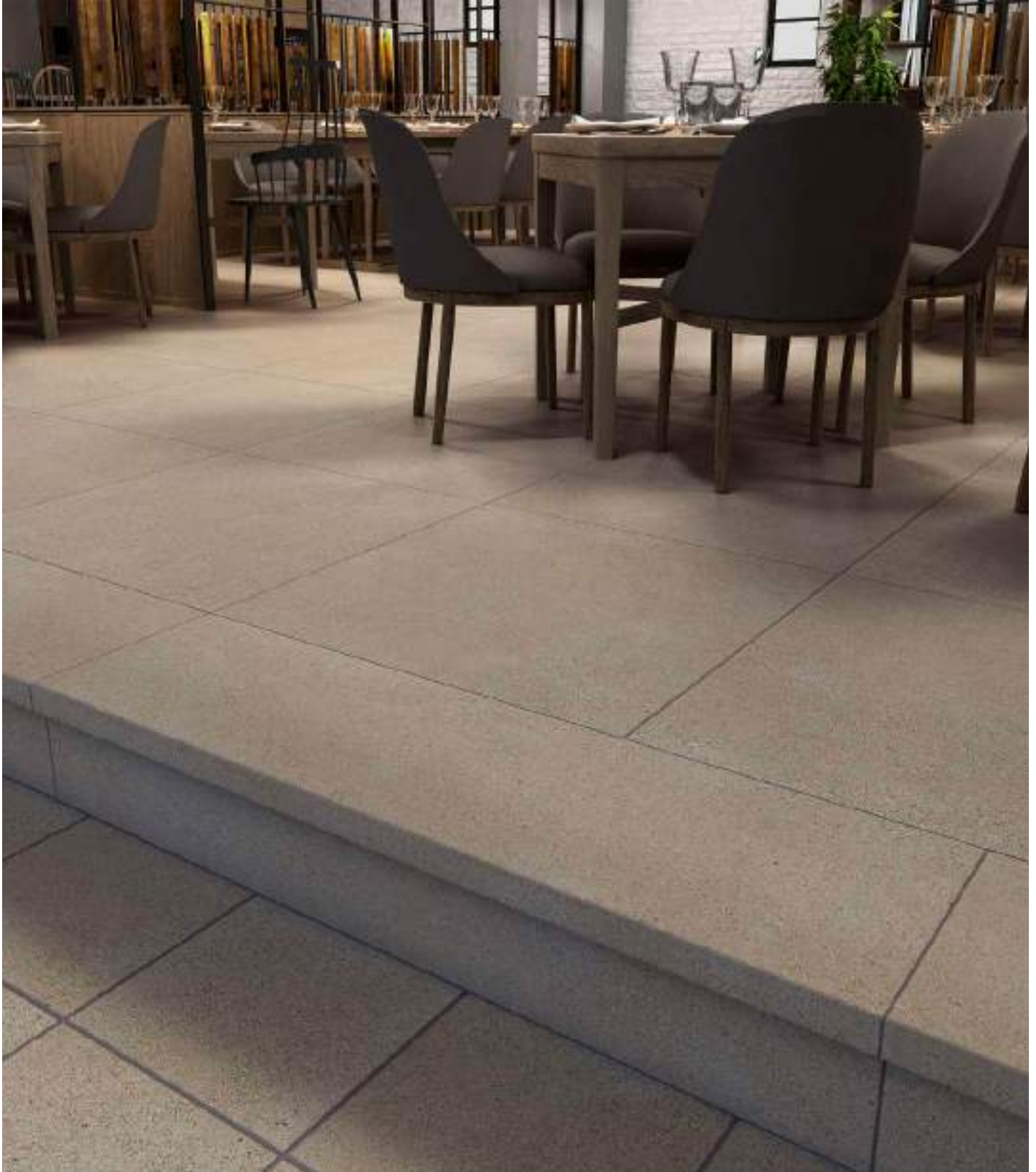

MILÁN / GRIS

GRES EXTRUIDO · EXTRUDED KLINKER · GRÈS EXTRUDÉ · ЭКСТРУДИРОВАННЫЙ КЕРАМОГРАНИТ
* GRES PORCELÁNICO · PORCELAIN STONEWARE · GRÈS PORCELAINÉ · КЕРАМОГРАНИТ



R9 C-1 Alb <1,5% V1
R12 C-3 CLASE C Bla <0,5%



FORMATOS · SIZES · FORMATS · ФОРМАТЫ

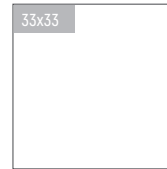

75x75* 75 x 75 cm - 29.5" x 29.5"	14,5x120* 14,5 x 120 cm - 5.7" x 47.2"	33x33 33 x 33 cm - 13.0" x 13.0"
± 11 mm	± 10,2 mm	± 10 mm
rectificado. rectified	rectificado. rectified	
C-1/C-3	C-1	C-3

* GRES PORCELÁNICO · PORCELAIN STONEWARE · GRÈS PORCELAINÉ · КЕРАМОГРАНИТ

PIEZAS ESPECIALES · SPECIAL PIECES · PIÈCES SPÉCIALES · СПЕЦИАЛЬНЫЕ ЭЛЕМЕНТЫ



PELDAÑO RECTO 120
33 x 120 x 3 cm - 13.0"x 47.2"x1.2"

- ✂ 12 mm
- ☑ rectificado, rectified
- ⊞ C-1/ C-3



PELDAÑO RECTO
33 x 33 x 3 cm - 13.0"x 13.0"x1.2"

- ✂ 12 mm
- ☑ rectificado, rectified
- ⊞ C-3



REMATE PELDAÑO RECTO
3 x 33 cm - 1.2"x 13.0"



RODAPIÉ
9 x 60 cm - 3.6"x 23.6"



ZANQUÍN RECTO DCHA/IZDA
42,3 x 17,5 cm - 16.7"x 7.0"



BORDE PISCINA SKIMMER
45 x 75 x 3 cm - 17.7"x 29.5"x1.2"

- ☑ rectificado, rectified
- ⊞ C-3

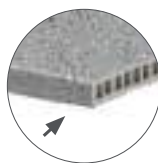

D. Continuidad gráfica, parte trasera.
Graphic continuous, backside.

3D DESIGN

MILÁN / GRIS

OUTDOOR: MILÁN GRIS 75x75 CM (C-3) - BORDE PISCINA SKIMMER 45x75x3 CM (C-3) - PELDAÑO RECTO MILÁN MARENGO 33x33 CM (C-3) - MILÁN MARENGO 33x33 CM (C-3)



INDOOR: MILÁN MARENGO 75x75 CM (C-1)



MILÁN / MARENGO

GRES EXTRUIDO · EXTRUDED KLINKER · GRÈS EXTRUDÉ · ЭКСТРУДИРОВАННЫЙ КЕРАМОГРАНИТ
* GRES PORCELÁNICO · PORCELAIN STONEWARE · GRÈS PORCELAINÉ · КЕРАМОГРАНИТ



R9
R12

C- 1
C- 3

CLASE C

Alb <1,5%
Bla <0,5%

v1

d



FORMATOS · SIZES · FORMATS · ФОРМАТЫ

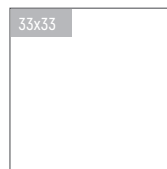

75x75*

75 x 75 cm - 29.5" x 29.5"

± 11 mm

rectificado. rectified

C-1/C-3

14,5x120*

14,5 x 120 cm - 5.7" x 47.2"

± 10,2 mm

rectificado. rectified

C-1

33x33

33 x 33 cm - 13.0" x 13.0"

± 10 mm

C-3

* GRES PORCELÁNICO · PORCELAIN STONEWARE · GRÈS PORCELAINÉ · КЕРАМОГРАНИТ

PIEZAS ESPECIALES · SPECIAL PIECES · PIÈCES SPÉCIALES · СПЕЦИАЛЬНЫЕ ЭЛЕМЕНТЫ



PELDAÑO RECTO 120
33 x 120 x 3 cm - 13.0"x 47.2"x1.2"

- ✂ 12 mm
- 📐 rectificado, rectified
- ⊕ C-1/ C-3



PELDAÑO RECTO
33 x 33 x 3 cm - 13.0"x 13.0"x1.2"

- ✂ 12 mm
- 📐 rectificado, rectified
- ⊕ C-3



REMATE PELDAÑO RECTO
3 x 33 cm - 1.2"x 13.0"



RODAPIÉ
9 x 60 cm - 3.6"x 23.6"



ZANQUÍN RECTO DCHA/IZDA
42,3 x 17,5 cm - 16.7"x 7.0"



BORDE PISCINA SKIMMER
45 x 75 x 3 cm - 17.7"x 29.5"x1.2"

- 📐 rectificado, rectified
- ⊕ C-3



D. Continuidad gráfica, parte trasera.
Graphic continuous, backside.

3D DESIGN

MILÁN / MARENGO

OUTDOOR: MILÁN MARENGO 75x75 CM (C-3) - BORDE PISCINA SKIMMER 45x75x3 CM (C-3) - PELDAÑO RECTO 33x120x3 CM (C-3)



INDOOR: MILÁN MARENGO 75x75 CM (C-1)



STONE

ALBAROC

NATURAL STONE ESSENCE
IN&OUTDOOR
STAIRS
SWIMMINGPOOLS



COLORS:

BOAL
GALENA
HULLA

SIZES (cm):

100x100 cm
14,5x120 cm
33x66,5 cm
33x33 cm

SIZES (inches):

39.4"x39.4"
5.7"x47.2"
13.0"x26.2"
13.0"x13.0"



OUTDOOR: ALBAROC HULLA 33x66,5 CM [C-3] - PELDAÑO RECTO 33x120x3 CM [C-3]

INDOOR: ALBAROC HULLA 33x66,5 CM [C-1]

ALBAROC / BOAL

GRES EXTRUIDO · EXTRUDED KLINKER · GRÈS EXTRUDÉ · ЭКСТРУДИРОВАННЫЙ КЕРАМОГРАНИТ
 * GRES PORCELÁNICO · PORCELAIN STONEWARE · GRÈS PORCELAINÉ · КЕРАМОГРАНИТ



R10 C-1 Alb <1,5%
 R12 C-3 Bla <0,5%

V2



FORMATOS · SIZES · FORMATS · ФОРМАТЫ

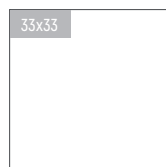
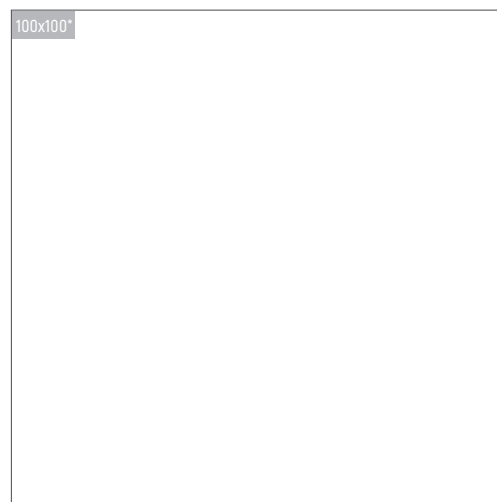

100x100*
 100 x 100 cm -
 39.4" x 39.4"

✂ 11 mm
 rectificado. rectified
 C-1/C-3

14,5x120*
 14,5 x 120 cm -
 5.7" x 47.2"

✂ 10,2 mm
 rectificado. rectified
 C-1

33x66,5
 33 x 66,5 cm -
 13.0" x 26.2"

✂ 10 mm
 C-1/C-3

33x33
 33 x 33 cm -
 13.0" x 13.0"

✂ 10 mm
 C-1/C-3

* GRES PORCELÁNICO · PORCELAIN STONEWARE · GRÈS PORCELAINÉ · КЕРАМОГРАНИТ

PIEZAS ESPECIALES · SPECIAL PIECES · PIÈCES SPÉCIALES · СПЕЦИАЛЬНЫЕ ЭЛЕМЕНТЫ



PELDAÑO RECTO 120
33 x 120 x 3 cm - 13.0" x 47.2" x 1.2"

✂ 12 mm
 rectificado. rectified
 C-3



REMATE PELDAÑO RECTO
3 x 33 cm - 1.2" x 13.0"



PELDAÑO ML
33 x 33 x 4 cm - 13.0" x 13.0" x 1.6"

✂ 13 mm
 C-3



CARTABÓN ML
33 x 33 x 4 cm - 13.0" x 13.0" x 1.6"

✂ 14 mm
 rectificado. rectified
 C-3



RODAPIÉ
9 x 40 cm - 3.6" x 15.7"

✂ 15 mm



ZANQUÍN ML IZDA./DCHA.
18 x 40 cm - 7.1" x 15.7"

✂ 15 mm



ZANQUÍN RECTO IZDA./DCHA.
18 x 40 cm - 7.1" x 15.7"

✂ 15 mm



PASAMANOS 12*
12,5 x 66,5 x 4 cm - 4.9" x 26.2" x 1.6"



PASAMANOS 15*
15,5 x 66,5 x 4 cm - 6.1" x 26.2" x 1.6"

*medidas interiores. interior dimensions.

ALBAROC / BOAL

OUTDOOR: ALBAROC BOAL 33x66,5 CM (C-3) - PASAMANOS 15x66,5x4 CM



INDOOR: ALBAROC BOAL 33x33 CM (C-1) - PELDAÑO ML 33x33x4 CM (C-3) - CARTABÓN ML 33x33x4 CM (C-3)



ALBAROC / GALENA

GRES EXTRUIDO · EXTRUDED KLINKER · GRÈS EXTRUDÉ · ЭКСТРУДИРОВАННЫЙ КЕРАМОГРАНИТ
 * GRES PORCELÁNICO · PORCELAIN STONEWARE · GRÈS PORCELAINÉ · КЕРАМОГРАНИТ



R10 C- 1 Alb <1,5%
 R12 C- 3 Bla <0,5%

V2



FORMATOS · SIZES · FORMATS · ФОРМАТЫ

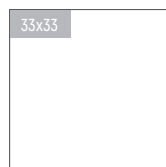
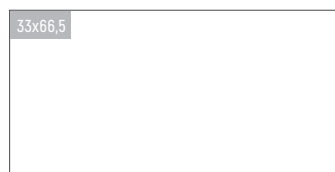
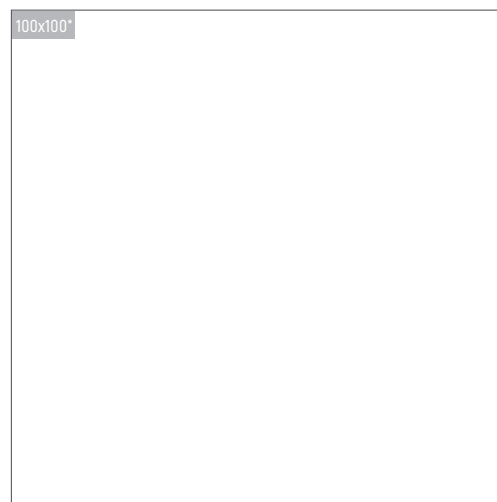

100x100*
 100 x 100 cm -
 39.4" x 39.4"

✂ 11 mm
 rectificado. rectified
 C-1/C-3

14,5x120*
 14,5 x 120 cm -
 5.7" x 47.2"

✂ 10,2 mm
 rectificado. rectified
 C-1

33x66,5
 33 x 66,5 cm -
 13.0" x 26.2"

✂ 10 mm
 C-1/C-3

33x33
 33 x 33 cm -
 13.0" x 13.0"

✂ 10 mm
 C-1/C-3

* GRES PORCELÁNICO · PORCELAIN STONEWARE · GRÈS PORCELAINÉ · КЕРАМОГРАНИТ

PIEZAS ESPECIALES · SPECIAL PIECES · PIÈCES SPÉCIALES · СПЕЦИАЛЬНЫЕ ЭЛЕМЕНТЫ



PELDAÑO RECTO 120
33 x 120 x 3 cm - 13.0" x 47.2" x 1.2"

✂ 12 mm
 rectificado. rectified
 C-3



REMATE PELDAÑO RECTO
3 x 33 cm - 1.2" x 13.0"



PELDAÑO ML
33 x 33 x 4 cm - 13.0" x 13.0" x 1.6"

✂ 13 mm
 C-3



CARTABÓN ML
33 x 33 x 4 cm - 13.0" x 13.0" x 1.6"

✂ 14 mm
 rectificado. rectified
 C-3



RODAPIÉ
9 x 40 cm - 3.6" x 15.7"

✂ 15 mm



ZANQUÍN ML IZDA./DCHA.
18 x 40 cm - 7.1" x 15.7"

✂ 15 mm



ZANQUÍN RECTO IZDA./DCHA.
18 x 40 cm - 7.1" x 15.7"

✂ 15 mm



PASAMANOS 12*
12,5 x 66,5 x 4 cm - 4.9" x 26.2" x 1.6"



PASAMANOS 15*
15,5 x 66,5 x 4 cm - 6.1" x 26.2" x 1.6"

*medidas interiores. interior dimensions.

ALBAROC / GALENA

INDOOR: ALBAROC GALENA 100x100 CM (C-1) - ALBAROC GALENA 14,5x120 (C-1) - PELDAÑO RECTO 33x120x3 CM (C-3) - REMATE PELDAÑO RECTO 3x33 CM





ALBAROC / HULLA

GRES EXTRUIDO · EXTRUDED KLINKER · GRÈS EXTRUDÉ · ЭКСТРУДИРОВАННЫЙ КЕРАМОГРАНИТ

* GRES PORCELÁNICO · PORCELAIN STONEWARE · GRÈS PORCELAINÉ · КЕРАМОГРАНИТ



R10
R12

C- 1
C- 3

Alb <1,5%
Bla <0,5%

V2



FORMATOS · SIZES · FORMATS · ФОРМАТЫ

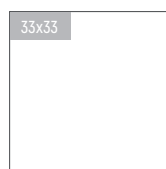
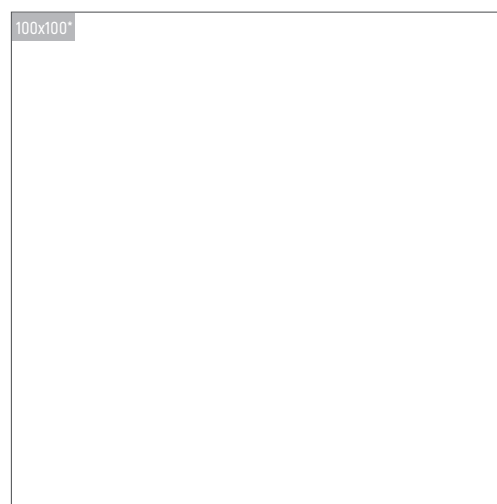

100x100*
100 x 100 cm -
39.4" x 39.4"

✂ 11 mm
📏 rectificado. rectified
📏 C-1/C-3

14,5x120*
14,5 x 120 cm -
5.7" x 47.2"

✂ 10,2 mm
📏 rectificado. rectified
📏 C-1

33x66,5
33 x 66,5 cm -
13.0" x 26.2"

✂ 10 mm
📏 C-1/C-3

33x33
33 x 33 cm -
13.0" x 13.0"



✂ 10 mm
📏 C-1/C-3

* GRES PORCELÁNICO · PORCELAIN STONEWARE · GRÈS PORCELAINÉ · КЕРАМОГРАНИТ

PIEZAS ESPECIALES · SPECIAL PIECES · PIÈCES SPÉCIALES · СПЕЦИАЛЬНЫЕ ЭЛЕМЕНТЫ



PELDAÑO RECTO 120
33 x 120 x 3 cm - 13.0" x 47.2" x 1.2"

✂ 12 mm
 rectificado. rectified
 C-3



REMATE PELDAÑO RECTO
3 x 33 cm - 1.2" x 13.0"



PELDAÑO ML
33 x 33 x 4 cm - 13.0" x 13.0" x 1.6"

✂ 13 mm
 C-3



CARTABÓN ML
33 x 33 x 4 cm - 13.0" x 13.0" x 1.6"

✂ 14 mm
 rectificado. rectified
 C-3



RODAPIÉ
9 x 40 cm - 3.6" x 15.7"

✂ 15 mm



ZANQUÍN ML IZDA./DCHA.
18 x 40 cm - 7.1" x 15.7"

✂ 15 mm



ZANQUÍN RECTO IZDA./DCHA.
18 x 40 cm - 7.1" x 15.7"

✂ 15 mm



PASAMANOS 12*
12,5 x 66,5 x 4 cm - 4.9" x 26.2" x 1.6"



PASAMANOS 15*
15,5 x 66,5 x 4 cm - 6.1" x 26.2" x 1.6"

*medidas interiores. interior dimensions.

ALBAROC / HULLA

OUTDOOR: ALBAROC HULLA 100x100 CM (C-3) - ALBAROC HULLA 14,5x120 CM (C-1) - PELDAÑO RECTO 33x120x3 CM (C-3) - PASAMANOS 15x66,5x4 CM





STONE

LITOS

STONE & CEMENT FUSION
IN&OUTDOOR
STAIRS
LARGE FORMATS
SWIMMINGPOOLS



COLORS:

ÁRTICO
SABANA
SIBERIA

SIZES (cm):

100x100 cm
60x120 cm
14,5x120 cm
33x66,5 cm

SIZES (inches):

39.4"x39.4"
23.7"x47.2"
5.7"x47.2"
13.0"x26.2"



LITOS SIBERIA 33x66,5 CM [C-1/C-3] - LITOS SIBERIA 14,5x120 CM [C-1] - LITOS SIBERIA 60x120 CM [C-3] - BORDE DESBORDANTE 28x66,5 CM [C-3] - REJILLA 24,5x24,5 CM [C-3] - ÁNGULO REJILLA IZDA. DCHA. 24,5x33 CM [C-3] - MEDIA CAÑA 33x4 CM - UÑA 4x4 CM

LITOS / ÁRTICO

GRES EXTRUIDO · EXTRUDED KLINKER · GRÈS EXTRUDÉ · ЭКСТРУДИРОВАННЫЙ КЕРАМОГРАНИТ

* GRES PORCELÁNICO · PORCELAIN STONEWARE · GRÈS PORCELAINÉ · КЕРАМОГРАНИТ



R9 R12 C- 1 C- 3 CLASE C Alb <1,5% Bla <0,5% V2



FORMATOS · SIZES · FORMATS · ФОРМАТЫ

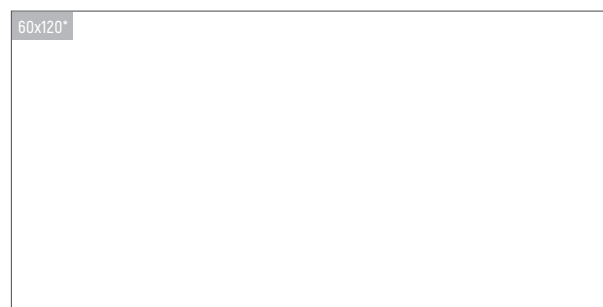
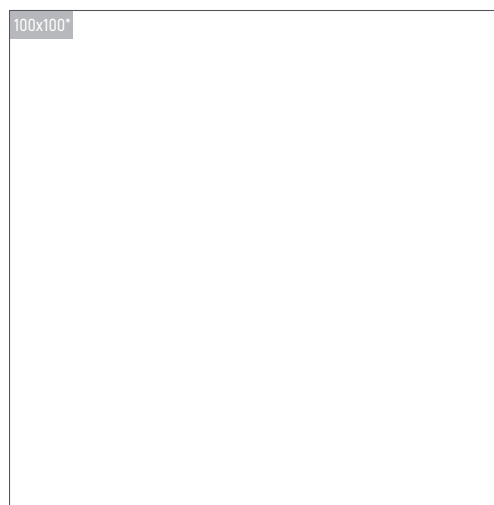

100x100*
100 x 100 cm -
39.4"x 39.4"

✂ 11 mm
✂ rectificado. rectified
✂ C-1/C-3

60x120*
60 x 120 cm -
23.7"x 47.2"

✂ 10,2 mm
✂ rectificado. rectified
✂ C-1/C-3

14,5x120*
14,5 x 120 cm -
5.7"x 47.2"

✂ 10,2 mm
✂ rectificado. rectified
✂ C-1

33x66,5
33 x 66,5 cm -
13.0"x 26.2"

✂ 10 mm
✂ C-1/C-3

* GRES PORCELÁNICO · PORCELAIN STONEWARE · GRÈS PORCELAINÉ · КЕРАМОГРАНИТ

PIEZAS ESPECIALES · SPECIAL PIECES · PIÈCES SPÉCIALES · СПЕЦИАЛЬНЫЕ ЭЛЕМЕНТЫ



PELDAÑO RECTO 120
33 x 120 x 3 cm - 13.0"x 47.2"x 1.2"

✂ 12 mm
 rectificado, rectified
 C-3



REMATE PELDAÑO RECTO
3 x 33 cm - 1.2"x 13.0"



RODAPIÉ
9 x 40 cm - 3.6"x 15.7"
✂ 15 mm



ZANQUÍN RECTO DCHA/IZDA
40 x 18 cm - 15.7"x 7.1"
✂ 15 mm



BORDE DESBORDANTE
28 x 66,5 cm - 11.0"x 26.2"

rectificado, rectified
 C-3



ÁNGULO DESBORDANTE
33 x 33 cm - 13.0"x 13.0"

rectificado, rectified
 C-3



REJILLA
24,5 x 24,5 cm - 9.6"x 9.6"

rectificado, rectified
 C-3



ÁNGULO REJILLA DERECHA*
24,5 x 33 cm - 9.6"x 13.0"

rectificado, rectified
 C-3



ÁNGULO REJILLA IZQUIERDA*
24,5 x 33 cm - 9.6"x 13.0"

rectificado, rectified
 C-3

*set de 2 piezas (dcha./izda.) *two pieces set (right/left)



MEDIA CAÑA
33 x 4 cm - 13.0"x 1.6"
r-3 cm



UÑA
4 x 4 cm - 1.6"x 1.6"
r-3 cm



ARISTA
33 x 3 cm - 13.0"x 1.2"
r-3 cm



UÑA ARISTA
3 x 3 cm - 1.2"x 1.2"

LITOS / ÁRTICO

INDOOR: LITOS ÁRTICO 60x120 CM (C-3) / 33x66,5 CM (C-1) / 14,5x120 CM (C-1) - BORDE DESBORDANTE 28x66,5 CM (C-3) - REJILLA 24,5X24,5 CM (C-3) - MEDIA CAÑA 33x4 CM - UÑA 4x4 CM



OUTDOOR: LITOS ÁRTICO 60x120 CM (C-3)



LITOS / SABANA

GRES EXTRUIDO · EXTRUDED KLINKER · GRÈS EXTRUDÉ · ЭКСТРУДИРОВАННЫЙ КЕРАМОГРАНИТ
 * GRES PORCELÁNICO · PORCELAIN STONEWARE · GRÈS PORCELAINÉ · КЕРАМОГРАНИТ



R9 R12 C-1 C-3 CLASE C Alb <1,5% Bla <0,5% V2



FORMATOS · SIZES · FORMATS · ФОРМАТЫ

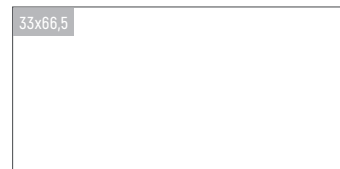
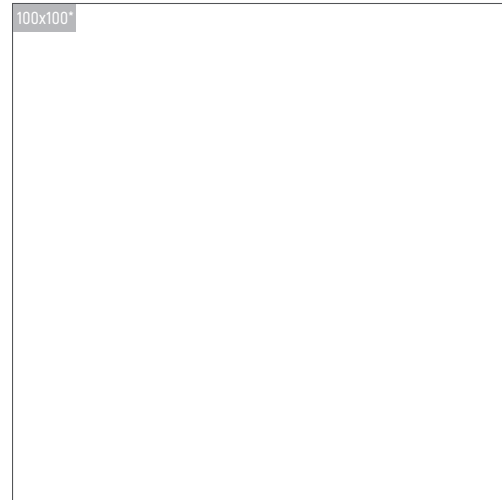

100x100*
 100 x 100 cm -
 39.4"x 39.4"

✂ 11 mm
 rectificado. rectified
 C-1/C-3

60x120*
 60 x 120 cm -
 23.7"x 47.2"

✂ 10,2 mm
 rectificado. rectified
 C-1/C-3

14,5x120*
 14,5 x 120 cm -
 5.7"x 47.2"

✂ 10,2 mm
 rectificado. rectified
 C-1

33x66,5
 33 x 66,5 cm -
 13.0"x 26.2"

✂ 10 mm
 C-1/C-3

* GRES PORCELÁNICO · PORCELAIN STONEWARE · GRÈS PORCELAINÉ · КЕРАМОГРАНИТ

PIEZAS ESPECIALES · SPECIAL PIECES · PIÈCES SPÉCIALES · СПЕЦИАЛЬНЫЕ ЭЛЕМЕНТЫ



PELDAÑO RECTO 120
33 x 120 x 3 cm - 13.0"x 47.2"x1.2"

✂ 12 mm
 rectificado, rectified
 C-3



REMATE PELDAÑO RECTO
3 x 33 cm - 1.2"x 13.0"



RODAPIÉ
9 x 40 cm - 3.6"x 15.7"



ZANQUÍN RECTO DCHA/IZDA
40 x 18 cm - 15.7"x 7.1"



BORDE DESBORDANTE
28 x 66,5 cm - 11.0"x26.2"

rectificado, rectified
 C-3



ÁNGULO DESBORDANTE
33 x 33 cm - 13.0"x13.0"

rectificado, rectified
 C-3



REJILLA
24,5 x 24,5 cm - 9.6"x9.6"

rectificado, rectified
 C-3



ÁNGULO REJILLA DERECHA*
24,5 x 33 cm - 9.6"x13.0"

rectificado, rectified
 C-3



ÁNGULO REJILLA IZQUIERDA*
24,5 x 33 cm - 9.6"x13.0"

rectificado, rectified
 C-3

*set de 2 piezas (dcha./izda.) *two pieces set (right/left)



MEDIA CAÑA
33 x 4 cm - 13.0"x 1.6"
r-3 cm



UÑA
4 x 4 cm - 1.6"x 1.6"
r-3 cm



ARISTA
33 x 3 cm - 13.0"x 1.2"
r-3 cm



UÑA ARISTA
3 x 3 cm - 1.2"x 1.2"

LITOS / SABANA

OUTDOOR: LITOS SABANA 33x66,5 CM (C-3) / 14,5x120 CM (C-1) - PELDAÑO RECTO 33x120x3 CM (C-3) - BORDE DESBORDANTE 28x66,5 CM (C-3) - REJILLA 24,5x24,5 CM (C-3)-



LITOS SABANA 33x66,5 CM (C-1)

INDOOR: LITOS SABANA 60x120 CM (C-1)



LITOS / SIBERIA

GRES EXTRUIDO · EXTRUDED KLINKER · GRÈS EXTRUDÉ · ЭКСТРУДИРОВАННЫЙ КЕРАМОГРАНИТ
 * GRES PORCELÁNICO · PORCELAIN STONEWARE · GRÈS PORCELAINÉ · КЕРАМОГРАНИТ



R9 R12 C-1 C-3 CLASE C Alb <1,5% Bla <0,5% V2



FORMATOS · SIZES · FORMATS · ФОРМАТЫ

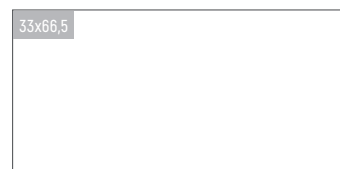
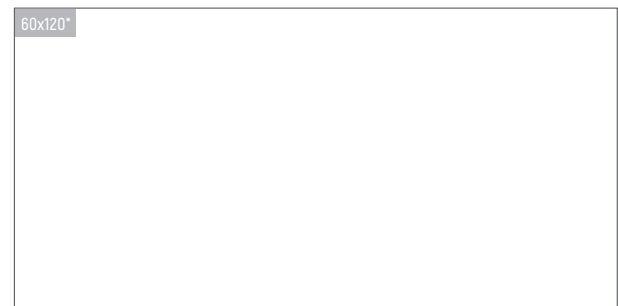
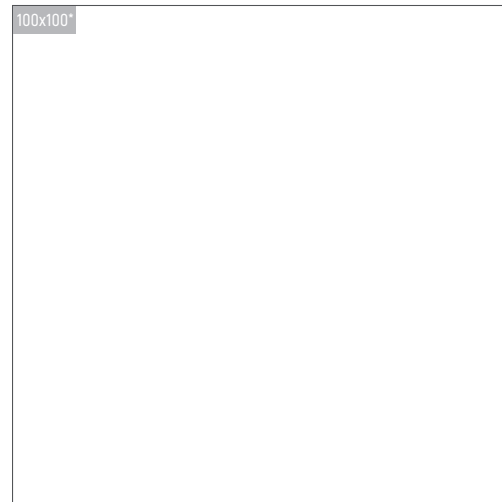

100x100*
 100 x 100 cm -
 39.4"x 39.4"

✂ 11 mm
 ✂ rectificado. rectified
 ✂ C-1/C-3

60x120*
 60 x 120 cm -
 23.7"x 47.2"

✂ 10,2 mm
 ✂ rectificado. rectified
 ✂ C-1/C-3

14,5x120*
 14,5 x 120 cm -
 5.7"x 47.2"

✂ 10,2 mm
 ✂ rectificado. rectified
 ✂ C-1

33x66,5
 33 x 66,5 cm -
 13.0"x 26.2"

✂ 10 mm
 ✂ C-1/C-3

* GRES PORCELÁNICO · PORCELAIN STONEWARE · GRÈS PORCELAINÉ · КЕРАМОГРАНИТ

PIEZAS ESPECIALES · SPECIAL PIECES · PIÈCES SPÉCIALES · СПЕЦИАЛЬНЫЕ ЭЛЕМЕНТЫ



PELDAÑO RECTO 120
33 x 120 x 3 cm - 13.0"x 47.2"x1.2"

✂ 12 mm
 rectificado, rectified
 C-3



REMATE PELDAÑO RECTO
3 x 33 cm - 1.2"x 13.0"



RODAPIÉ
9 x 40 cm - 3.6"x 15.7"



ZANQUÍN RECTO DCHA/IZDA
40 x 18 cm - 15.7"x 7.1"



BORDE DESBORDANTE
28 x 66,5 cm - 11.0"x26.2"

rectificado, rectified
 C-3



ÁNGULO DESBORDANTE
33 x 33 cm - 13.0"x13.0"

rectificado, rectified
 C-3



REJILLA
24,5 x 24,5 cm - 9.6"x9.6"

rectificado, rectified
 C-3



ÁNGULO REJILLA DERECHA*
24,5 x 33 cm - 9.6"x13.0"

rectificado, rectified
 C-3



ÁNGULO REJILLA IZQUIERDA*
24,5 x 33 cm - 9.6"x13.0"

rectificado, rectified
 C-3

*set de 2 piezas (dcha./izda.) *two pieces set (right/left)



MEDIA CAÑA
33 x 4 cm - 13.0"x 1.6"



UÑA
4 x 4 cm - 1.6"x 1.6"



ARISTA
33 x 3 cm - 13.0"x 1.2"



UÑA ARISTA
3 x 3 cm - 1.2"x 1.2"

LITOS / SIBERIA

INDOOR: LITOS SIBERIA 100x100 CM (C-1) / 60x120 CM (C-1) / 14,5x120 CM (C-1) - PELDAÑO RECTO 33x120x3 CM (C-3) - REMATE PELDAÑO RECTO 3x33 CM





STONE

ROCA

QUARTZ INSPIRATION
IN&OUTDOOR
STAIRS
SWIMMINGPOOLS



COLORS:

POLAR

SIZES (cm):

33x66,5 cm
33x33 cm

SIZES (inches):

13.0"x26.2"
13.0"x13.0"

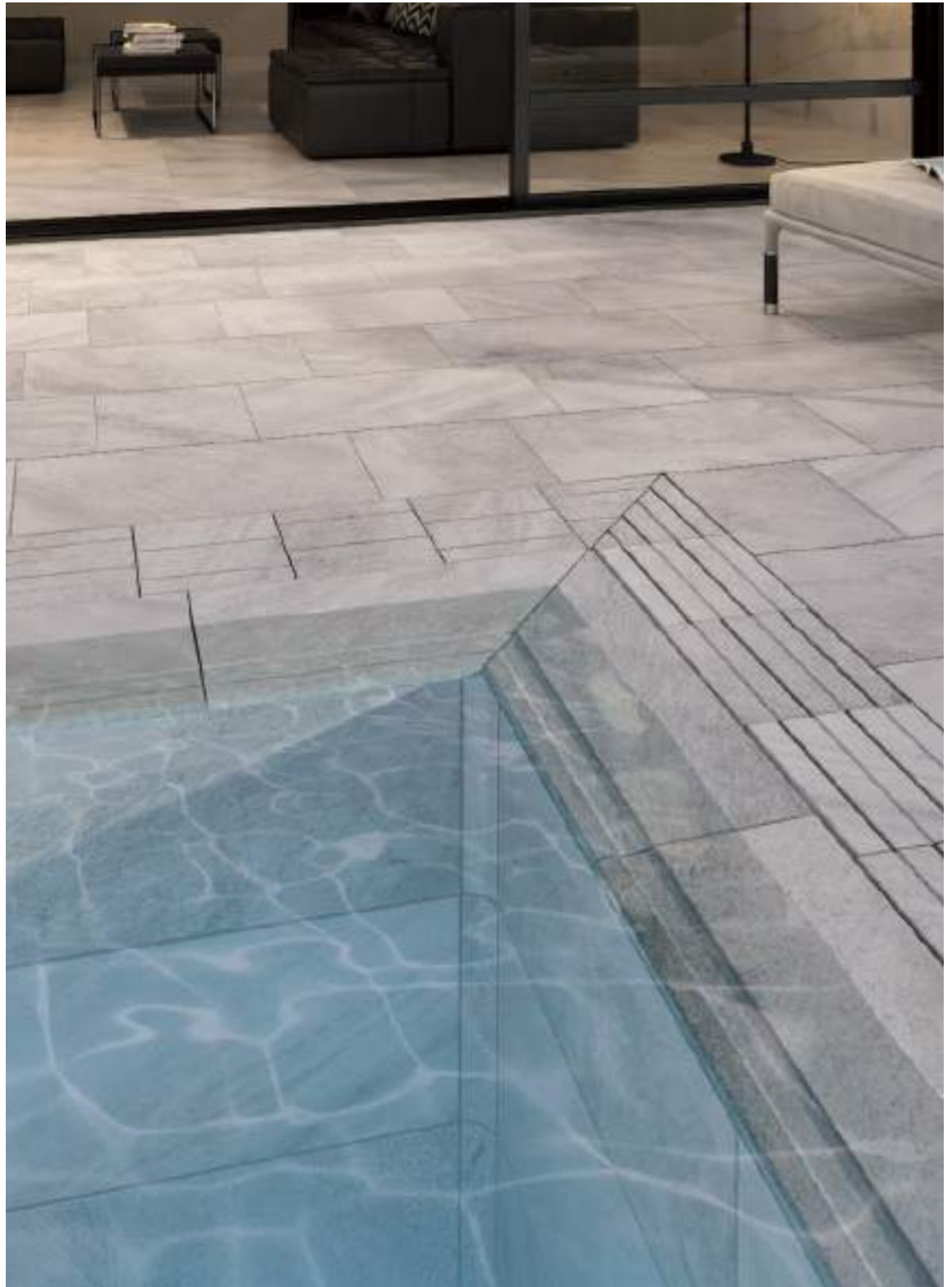

ROCA POLAR 33x66,5 CM [C-1/C-3] / 33x33 CM [C-3] - BORDE DESBORDANTE 28x66,5 CM [C-3] - REJILLA 24,5x24,5 CM [C-3] - MEDIA CAÑA 33x4 CM

ROCA / POLAR

GRES EXTRUIDO · EXTRUDED KLINKER · GRÈS EXTRUDÉ · ЭКСТРУДИРОВАННЫЙ КЕРАМОГРАНИТ



R9
R12

C-1
C-3

CLASE C

Alb <1,5%

V3



FORMATOS · SIZES · FORMATS · ФОРМАТЫ



33x66,5
33 x 66,5 cm - 13.0" x 26.2"

± 10 mm
■ C-1/C-3

33x33
33 x 33 cm - 13.0" x 13.0"

± 10 mm
■ C-3

PIEZAS ESPECIALES · SPECIAL PIECES · PIÈCES SPÉCIALES · СПЕЦИАЛЬНЫЕ ЭЛЕМЕНТЫ



PELDAÑO ML
33 x 33 x 4 cm - 13.0" x 13.0" x 1.6"

✂ 13 mm
☒ C-3



CARTABÓN ML
33 x 33 x 4 cm - 13.0" x 13.0" x 1.6"

✂ 14 mm
☒ rectificado, rectified
☒ C-3



PELDAÑO RECTO
33 x 33 x 3 cm - 13.0" x 13.0" x 1.2"

✂ 12 mm
☒ C-1 / C-3



RODAPIÉ
9 x 33 cm - 3.5" x 13.0"



ZANQUÍN ML IZDA./DCHA.
39,5 x 17,5 cm - 15.6" x 6.9"



ZANQUÍN RECTO IZDA./DCHA.
42,3 x 17,5 cm - 16.7" x 6.9"



BORDE DESBORDANTE
28 x 66,5 cm - 11.0" x 26.2"

☒ rectificado, rectified
☒ C-3



ÁNGULO DESBORDANTE
33 x 33 cm - 13.0" x 13.0"

☒ rectificado, rectified
☒ C-3



REJILLA
24,5 x 24,5 cm - 9.6" x 9.6"

☒ rectificado, rectified
☒ C-3



ÁNGULO REJILLA DERECHA*
24,5 x 33 cm - 9.6" x 13.0"

☒ rectificado, rectified
☒ C-3



ÁNGULO REJILLA IZQUIERDA*
24,5 x 33 cm - 9.6" x 13.0"

☒ rectificado, rectified
☒ C-3

*set de 2 piezas [dcha./izda.] *two pieces set [right/left]



MEDIA CAÑA
33 x 4 cm - 13.0" x 1.6"
r-3 cm



UÑA
4 x 4 cm - 1.6" x 1.6"



ARISTA
33 x 3 cm - 13.0" x 1.2"
r-3 cm



UÑA ARISTA
3 x 3 cm - 1.2" x 1.2"

ROCA / POLAR

OUTDOOR: ROCA POLAR 33x33 CM [C-3] / 33x66,5 CM [C-3] - PELDAÑO RECTO 33x33x3 CM [C-3] - BORDE DESBORDANTE 28x66,5 CM [C-3] - REJILLA 24,5x24,5 CM [C-3]



INDOOR: ROCA POLAR 33x66,5 CM (C-1)



STONE

MANHATTAN

TRENDS AND TECHNICAL
SOLUTIONS IN EXTRUDED
BRICK
SMALL FORMAT
STAIRS



COLORS:

WHITE

GREY

MINK

RED

SIZES (cm):

24,5x24,5 cm

12x24,5 cm

5,75x24,5 cm

SIZES (inches):

9.6"x9.6"

4.7"x9.6"

2.3"x9.6"



OUTDOOR: MANHATTAN GREY 24,5x24,5 CM (C-2) - FAÇADE: MANHATTAN GREY 5,75x24,5 CM (C-2)

MANHATTAN /

GRES EXTRUIDO · EXTRUDED KLINKER · GRÈS EXTRUDÉ · ЭКСТРУДИРОВАННЫЙ КЕРАМОГРАНИТ



R11

C-2

Alb <1,5%

V3

WHITE

GREY

MINK

RED



FORMATOS · SIZES · FORMATS · ФОРМАТЫ

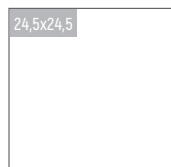

24,5x24,5
24,5 x 24,5 cm - 9.6"x 9.6"

± 9 mm
C-2



12x24,5
12 x 24,5 cm - 4.7"x 9.6"

± 9 mm
C-2



5,75x24,5*
5,75 x 24,5 cm - 2.3"x9.6"

± 9 mm
C-2

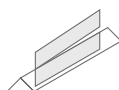

*El brick 5,75x24,5 se consigue de la plaqueta doble de precorte que se separa en obra.
The 5,75 x 24,5 brick is achieved from the double pre-cut plate that is separated on site.
Le brick 5,75 x 24,5 s'obtient par la double plaque de pré-découpage qui se sépare en construction.
Плитка 5,75 x 24,5 см получается из двойной пластины с предварительно сделанным пазом, которая разделяется при выполнении облицовочных работ.

PIEZAS ESPECIALES · SPECIAL PIECES · PIÈCES SPÉCIALES · СПЕЦИАЛЬНЫЕ ЭЛЕМЕНТЫ



PELDAÑO ML
24,5 x 33 x 4 cm - 9.6"x 13.0"x1.6"

± 13 mm
C-2



CARTABÓN FIORENTINO
33 x 33 x 4 cm - 13.0"x 13.0"x1.6"

± 14 mm
C-2
rectificado, rectified



ZANQUIN ML IZDA./DCHA.
39,5 x 17,5 cm - 15.8"x 7.0"



RODAPIÉ
9 x 24,5 cm - 3.6"x 9.6"



VIERTEAGUAS
15 x 24,5 x 4 cm - 5.9"x9.6"x1.6"

± 10 mm

MANHATTAN / WHITE

INDOOR: MANHATTAN WHITE 24,5x24,5 CM - MANHATTAN WHITE 12x24,5 CM - MANHATTAN WHITE 5,75x24,5 CM



MANHATTAN / GREY



OUTDOOR: MANHATTAN GREY 24,5x24,5 CM - PELDAÑO ML 24,5x33x4 CM - CARTABÓN ML 33x33x4 CM - VIERTEAGUAS 15x24,5x4 CM



MANHATTAN / MINK

INDOOR: MANHATTAN MINK 12x24,5 CM - MANHATTAN MINK 5,75x24,5 CM - PELDAÑO ML 24,5x33X4 CM - CARTABÓN ML 33x33x4 CM



MANHATTAN / RED



OUTDOOR: MANHATTAN RED 24,5x24,5 CM / 12x24,5 CM / 5,75x24,5 CM - VIERTEAGUAS 15x24,5x4 CM FAÇADE: MANHATTAN RED 24,5x24,5 CM - 12x24,5 CM



STONE

PETRA

STONE GRAPH EXTRUDED
STAIRS
SWIMMINGPOOLS



COLORS:	SIZES (cm):	SIZES (inches):
BONE		
OCRE		
GRIS	33x33 cm	13.0"x13.0"



PETRA GRIS 33x33 CM (C-3) - BORDE PISCINA 28x33 CM (C-3) - ÁMG. INTERIOR PISCINA 33x33 CM (C-3) - PELDAÑO FIORENTINO 33x33x3 CM (C-3)

PETRA /

GRES EXTRUIDO · EXTRUDED KLINKER · GRÈS EXTRUDÉ · ЭКСТРУДИРОВАННЫЙ КЕРАМОГРАНИТ

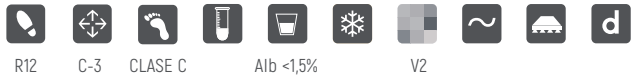

BONE

OCRE

GRIS



FORMATOS · SIZES · FORMATS · ФОРМАТЫ

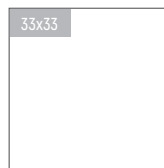

33x33
33 x 33 cm - 13.0"x 13.0"

± 10 mm

■ C-3

DECORADOS · DECORS · DÉCORÉ · УКРАШЕН



TABICA PETRA ETNA
15 x 33 cm - 5.9"x 13.0"

✂ 10 mm



TACO PETRA ETNA
8 x 8 cm - 3.15"x 3.15"

✂ 10 mm

PIEZAS ESPECIALES · SPECIAL PIECES · PIÈCES SPÉCIALES · СПЕЦИАЛЬНЫЕ ЭЛЕМЕНТЫ



PELDAÑO FIORENTINO
33 x 33 x 3 cm - 13.0"x 13.0"x 1.2"

✂ 12 mm

✂ C-3



CARTABÓN FIORENTINO
33 x 33 x 3 cm - 13.0"x 13.0"x 1.2"

✂ 14 mm

✂ C-3

📐 rectificado. rectified



ZANQUIN FIORENTINO IZDA./DCHA.
39,5 x 17,5 cm - 15.8"x 7.0"



RODAPÍE
9 x 33 cm - 3.6"x 13.0"



BORDE PISCINA
28 x 33 cm - 11.0"x 13.0"

✂ C-3



ÁNGULO INTERIOR PISCINA
33 x 33 cm - 13.0"x 13.0"

✂ C-3

📐 rectificado. rectified



ÁNGULO EXTERIOR PISCINA
28 x 28 cm - 11.0"x 11.0"

✂ C-3

📐 rectificado. rectified

PETRA / BONE

OUTDOOR: PETRA BONE 33x33 CM (C-3)



PETRA / GRIS



OUTDOOR: PETRA GRIS 33x33 CM [C-3]



STONE

VEGA

SOFT STONE WITH RELIEF
INDOOR
STAIRS



COLORS:

VISÓN
GRIS
ROJO
OCRE

SIZES (cm):

33x33 cm

SIZES (inches):

13.0"x13.0"



VEGA OCRE 33x33 CM [C-1] - RODAPIÉ 9x33 CM

VEGA /

GRES EXTRUIDO · EXTRUDED KLINKER · GRÈS EXTRUDÉ · ЭКСТРУДИРОВАННЫЙ КЕРАМОГРАНИТ



R9
R10

C-1
C-2

Alb <1,5%

V1

VISÓN

GRIS

ROJO

OCRE



FORMATOS · SIZES · FORMATS · ФОРМАТЫ



33x33
33 x 33 cm - 13.0" x 13.0"

✂ 10 mm
🔲 C-1 / C-2

PIEZAS ESPECIALES · SPECIAL PIECES · PIÈCES SPÉCIALES · СПЕЦИАЛЬНЫЕ ЭЛЕМЕНТЫ

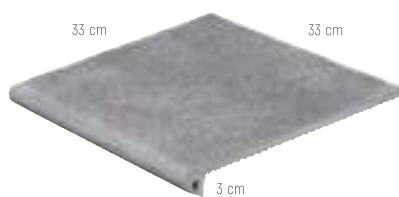

PELDAÑO FIORENTINO
33 x 33 x 3 cm - 13.0" x 13.0" x 1.2"

✂ 12 mm
🔲 C-1/C-2



CARTABÓN FIORENTINO
33 x 33 x 3 cm - 13.0" x 13.0" x 1.2"

✂ 14 mm
🔲 C-1/C-2
🔲 rectificado, rectified



ZANQUIN FIORENTINO IZDA./DCHA.
39,5 x 17,5 cm - 15.6" x 6.9"



RODAPIÉ
9 x 33 cm - 3.6" x 13.0"



VIERTEAGUAS
12 x 33 x 3 cm - 3.6" x 13.0" x 1.2"
✂ 12 mm

EARTH

LUCCA

RUSTIC & MEDITERRANEAN SPIRIT

IN&OUTDOOR

MULTIFORMAT

STAIRS

SWIMMINGPOOLS



COLORS:

TERRA
GRIGIO

SIZES (cm):

33x33 cm
16,25x33 cm
16,25x16,25 cm

SIZES (inches):

13.0"x13.0"
6.4"x13.0"
6.4"x6.4"

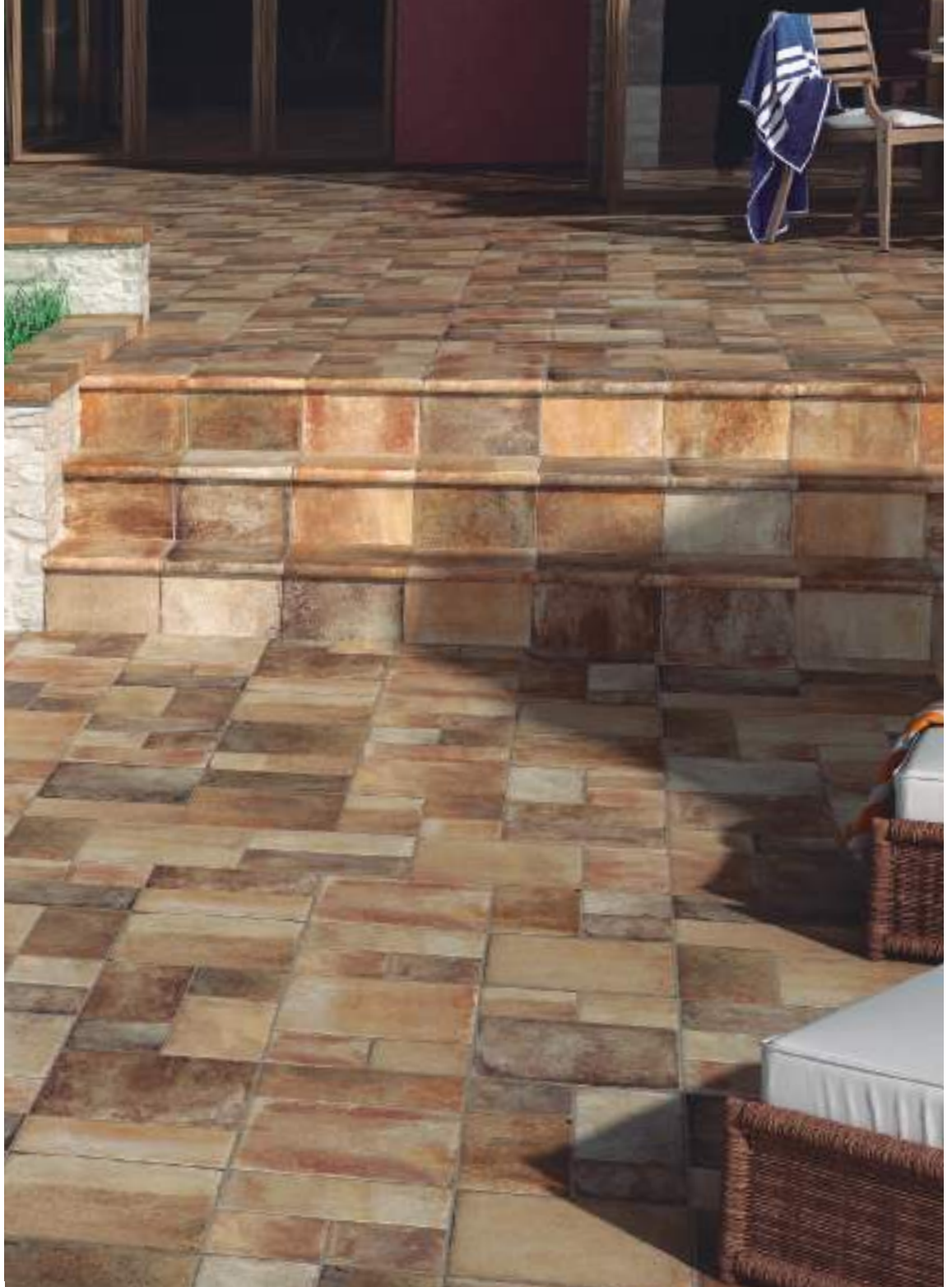

LUCCA / TERRA

GRES EXTRUIDO · EXTRUDED KLINKER · GRÈS EXTRUDÉ · ЭКСТРУДИРОВАННЫЙ КЕРАМОГРАНИТ

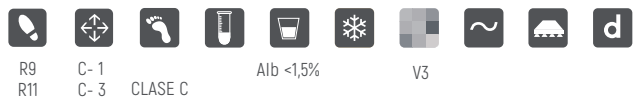

FORMATOS · SIZES · FORMATS · ФОРМАТЫ



33x33
33 x 33 cm - 13.0"x 13.0"
x 10 mm
C-1 / C-3

16,25x33
16,25 x 33 cm - 6.4"x 13.0"
x 10 mm
C-3

16,25x16,25
16,25 x 16,25 cm - 6.4"x 6.4"
x 10 mm
C-3

PIEZAS ESPECIALES · SPECIAL PIECES · PIÈCES SPÉCIALES · СПЕЦИАЛЬНЫЕ ЭЛЕМЕНТЫ



PELDAÑO ML
33 x 33 x 4 cm - 13.0" x 13.0" x 1.6"

✂ 13 mm
✂ C-3



CARTABÓN ML
33 x 33 x 4 cm - 13.0" x 13.0" x 1.6"

✂ 14 mm
✂ rectificado. rectified
✂ C-3



RODAPIÉ
9 x 33 cm - 3.5" x 13.0"



ZANQUÍN ML IZDA./DCHA.
39,5 x 17,5 cm - 15.6" x 6.9"



VIERTEAGUAS
15 x 33 x 4 cm - 5.9" x 13.0" x 1.6"

✂ C-3



BORDE PISCINA
28 x 33 cm - 11.0" x 13.0"

✂ C-3



ÁNGULO INTERIOR PISCINA
33 x 33 cm - 13.0" x 13.0"

✂ rectificado. rectified
✂ C-3

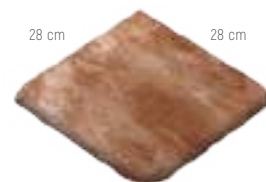

ÁNGULO EXTERIOR PISCINA
28 x 28 cm - 11.0" x 11.0"

✂ rectificado. rectified
✂ C-3

LUCCA / TERRA

OUTDOOR: LUCCA TERRA 33x33 CM (C-3) / 16,25x33 CM (C-3) / 16,25x16,25 CM (C-3) - VIERTEAGUAS 15x33x4 CM - PELDAÑO ML 33x33x4 CM (C-3) - BORDE PISCINA SKIMMER 28x33 CM (C-3)



ÁNGULO INTERIOR PISCINA 33x33 CM



LUCCA / GRIGIO

GRES EXTRUIDO · EXTRUDED KLINKER · GRÈS EXTRUDÉ · ЭКСТРУДИРОВАННЫЙ КЕРАМОГРАНИТ

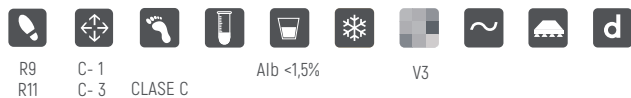

FORMATOS · SIZES · FORMATS · ФОРМАТЫ



33x33
33 x 33 cm - 13.0"x 13.0"
x 10 mm
C-1 / C-3

16,25x33
16,25 x 33 cm - 6.4"x 13.0"
x 10 mm
C-3

16,25x16,25
16,25 x 16,25 cm - 6.4"x 6.4"
x 10 mm
C-3

PIEZAS ESPECIALES · SPECIAL PIECES · PIÈCES SPÉCIALES · СПЕЦИАЛЬНЫЕ ЭЛЕМЕНТЫ



PELDAÑO ML
33 x 33 x 4 cm - 13.0" x 13.0" x 1.6"

✂ 13 mm
☒ C-3



CARTABÓN ML
33 x 33 x 4 cm - 13.0" x 13.0" x 1.6"

✂ 14 mm
☒ rectificado. rectified
☒ C-3



RODAPIÉ
9 x 33 cm - 3.5" x 13.0"



ZANQUÍN ML IZDA./DCHA.
39,5 x 17,5 cm - 15.6" x 6.9"



VIERTEAGUAS
15 x 33 x 4 cm - 5.9" x 13.0" x 1.6"

☒ C-3



BORDE PISCINA
28 x 33 cm - 11.0" x 13.0"

☒ C-3



ÁNGULO INTERIOR PISCINA
33 x 33 cm - 13.0" x 13.0"

☒ rectificado. rectified
☒ C-3



ÁNGULO EXTERIOR PISCINA
28 x 28 cm - 11.0" x 11.0"

☒ rectificado. rectified
☒ C-3

LUCCA / GRIGIO

INDOOR: LUCCA GRIGIO 33x33 CM (C-1) / 16,25x33 CM - PELDAÑO ML 33x33x4 CM - ZANQUÍN ML DCHA. 39,5x17,5 CM - RODAPIÉ 9x33 CM





EARTH

ALHAMAR

THE AGEING EFFECT OF NATURAL CLAY
IN&OUTDOOR
MULTIFORMAT
STAIRS
DECORS



COLORS:

BLANCO
PAJA
SALMÓN
ROJO

SIZES (cm):

33x33 cm
16,25x33 cm
16,25x16,25 cm

SIZES (inches):

13.0"x13.0"
6.4"x13.0"
6.4"x6.4"



OUTDOOR: ALHAMAR BLANCO 33x33 CM [C-3] - PELDAÑO FIORENTINO BLANCO 33x33x3 CM [C-3]

INDOOR: ALHAMAR BLANCO 33x33 CM [C-1]

ALHAMAR /

GRES EXTRUIDO · EXTRUDED KLINKER · GRÈS EXTRUDÉ · ЭКСТРУДИРОВАННЫЙ КЕРАМОГРАНИТ

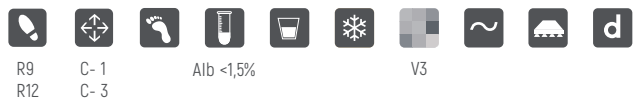

BLANCO

PAJA

SALMÓN

ROJO

FORMATOS · SIZES · FORMATS · ФОРМАТЫ

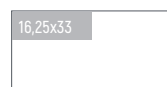

33x33
33 x 33 cm -
13.0"x 13.0"

× 10 mm
C-1 / C-3

16,25x33
16,25 x 33 cm -
6.4"x 13.0"

× 10 mm
C-3

16,25x16,25
16,25 x 16,25 cm -
6.4"x 6.4"

× 10 mm
C-3

DECORADOS · DECORATED · DÉCORÉ · УКРАШЕН



DECORATIVE
33 x 33 cm - 13.0" x 13.0"

⊠ 10 mm
C-3

*1 set 4 piezas - 4 pieces pack



CLAY
33 x 33 cm - 13.0" x 13.0"

⊠ 10 mm
C-3

*1 set 2 piezas - 2 pieces pack

TABICA CLAY
15 x 33 cm - 5.9" x 13.0"

⊠ 10 mm
C-3

*1 set 2 piezas - 2 pieces pack

PIEZAS ESPECIALES · SPECIAL PIECES · PIÈCES SPÉCIALES · СПЕЦИАЛЬНЫЕ ЭЛЕМЕНТЫ

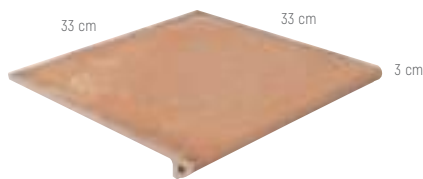

PELDAÑO FIORENTINO
33 x 33 x 3 cm - 13.0" x 13.0" x 1.2"

⊠ 12 mm
C-3

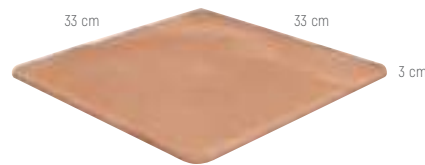

CARTABÓN FIORENTINO
33 x 33 x 3 cm - 13.0" x 13.0" x 1.2"

⊠ 14 mm
C-3
rectificado. rectified



RODAPIÉ
9 x 33 cm - 3.5" x 13.0"



ZANQUÍN FIORENTINO IZDA./DCHA.
39,5 x 17,5 cm - 15,6" x 6,9"

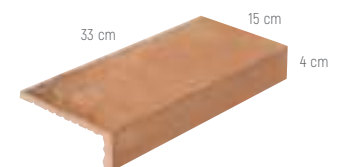

VIERTEAGUAS
15 x 33 x 4 cm - 5.9" x 13.0" x 1.6"

⊠ 10 mm
C-3

ALHAMAR / SALMÓN

OUTDOOR: ALHAMAR SALMÓN 33x33 CM (C-3) /16,25x33 CM (C-3) - PELDAÑO FIORENTINO 33x33x3 CM (C-3) - CARTABÓN FIORENTINO 33x33x3 CM



ALHAMAR / ROJO



INDOOR: ALHAMAR ROJO 33x33 CM (C-1) - DECORATIVE ROJO 33x33 CM (C-3)

OUTDOOR: ALHAMAR ROJO 33x33 CM (C-3) - VIERTEAGUAS 15x33x4 CM



METAL

METÁLICA

DESIGN AND METALLIC EFFECTS
INDOOR
STAIRS



COLORS:

PURPLE
CHERRY
BASALT
VULCANO

SIZES (cm):

33x33 cm

SIZES (inches):

13.0"x13.0"



METÁLICA /

GRES EXTRUIDO · EXTRUDED KLINKER · GRÈS EXTRUDÉ · ЭКСТРУДИРОВАННЫЙ КЕРАМОГРАНИТ



PURPLE

CHERRY

BASALT

VULCANO



PURPLE / CHERRY / BASALT / VULCANO

FORMATOS · SIZES · FORMATS · ФОРМАТЫ



33x33
33 x 33 cm - 13.0" x 13.0"

± 10 mm
C-1

PIEZAS ESPECIALES · SPECIAL PIECES · PIÈCES SPÉCIALES · СПЕЦИАЛЬНЫЕ ЭЛЕМЕНТЫ

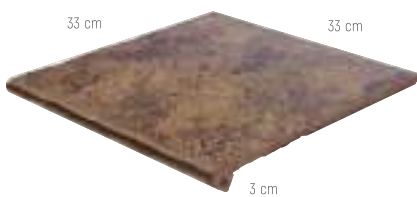

PELDAÑO FIORENTINO
33 x 33 x 3 cm - 13.0" x 13.0" x 1.2"

± 12 mm
C-1



CARTABÓN FIORENTINO
33 x 33 x 3 cm - 13.0" x 13.0" x 1.2"

± 14 mm
rectificado, rectified
C-1



ZANQUIN FIORENTINO IZDA./DCHA.
39,5 x 17,5 cm - 15.6" x 6.9"



RODAPIÉ
9 x 33 cm - 3.6" x 13.0"

METÁLICA / VULCANO

INDOOR: METÁLICA VULCANO 33x33 CM (C-1) - PELDAÑO FIORENTINO 33x33x3 CM





ESQUEMAS DE COLOCACIÓN MULTIFORMATO /

MULTIFORMAT LAYING PATTERNS · PLANS DE POSE · СХЕМЫ МУЛЬТИФОРМАТНОЙ УКЛАДКИ



LUCCA

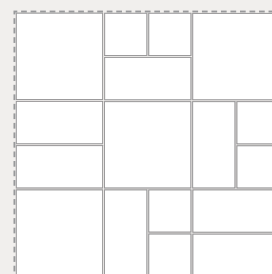

1 m²

33 x 33 cm	4 piezas. pieces
16,25 x 33 cm	7 piezas. pieces
16,25 x 16,25 cm	6 piezas. pieces



ALHAMAR

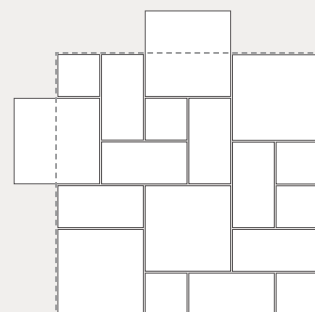

1 m²

33 x 33 cm	5 piezas. pieces
16,25 x 33 cm	7 piezas. pieces
16,25 x 16,25 cm	6 piezas. pieces



MANHATTAN

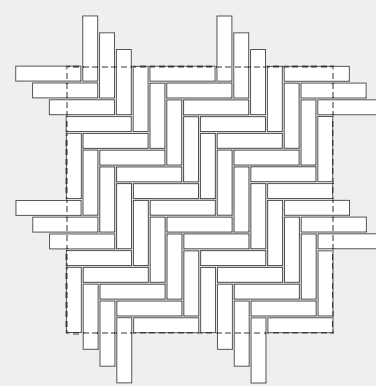

1 m²

5,75 x 24,5 cm | 76 uds/m²



ROCA POLAR

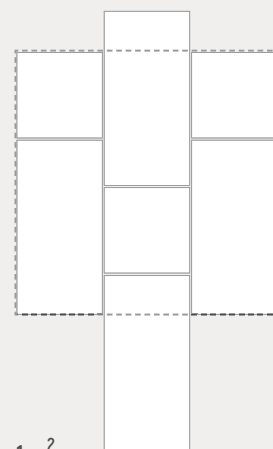

1 m²

33 x 66,5 cm | 4 piezas. pieces
33 x 33 cm | 3 piezas. pieces

Exagres se caracteriza por ofrecer una amplia gama de producto conformado mediante extrusión, con elevadas características técnicas, ideales tanto para el interior como el exterior de la vivienda, además de poderse dirigir a espacios públicos y privados.

Con el proceso de extrusión se consiguen piezas con determinadas geometrías y secciones complejas imposibles de alcanzar mediante el prensado, dando así soluciones completas para recubrimientos integrales y homogéneos con un mismo material cerámico.

Todo esto unido con la tecnología de impresión digital, que permite decorar con cualquier diseño la pieza cerámica por completo, desde los bajos relieves hasta los diferentes planos que ofrecen nuestras piezas, hace que Exagres pueda ofrecer un producto único y de calidad superior tanto técnica como estéticamente.

El objetivo principal de Exagres son los clientes, por ese motivo estamos al corriente de las últimas tendencias para poder ofrecer productos innovadores como soluciones en escalones de gran formato y piscinas.

Exagres is characterised by the wide range of products, shaped through extrusion, that it has on offer. These products have important technical characteristics, ideal for both inside and outside the home, as well as being suitable for both public and private spaces.

Through the extrusion process, pieces are obtained with certain geometries and complex sections that are impossible to achieve through compacting, thus providing complete solutions for integral and standardised cladding with the same ceramic material.

All of this, together with the digital printing technology which permits decoration on the entire ceramic piece with any design, from low relief to the various images offered by our pieces, means that Exagres can offer a unique product with superior quality both technically and aesthetically.

The principal objective of Exagres is our customers, therefore we stay up to date with the latest trends in order to be able to offer innovative products as solutions for large scale stairs and swimming pools.

La particularité d'**Exagres** est d'offrir une large gamme de produits mis en forme par extrusion, aux grandes caractéristiques techniques, idéales aussi bien pour l'intérieur que pour l'extérieur du logement, en plus de pouvoir s'adresser à des espaces publics et privés.

Grâce au procédé d'extrusion, il est possible d'obtenir des pièces aux géométries spécifiques et des sections complexes impossibles à atteindre par le pressage, apportant ainsi des solutions complètes pour des revêtements intégraux et homogènes avec un même matériau céramique.

Tout cela associé à la technologie d'impression numérique, qui permet de décorer entièrement avec n'importe quel design la pièce céramique, des bas-reliefs aux différents plans qu'offrent nos pièces, permet à Exagres d'offrir un produit unique et de qualité supérieure aussi bien technique qu'esthétique.

L'objectif principal d'Exagres sont les clients, pour cette raison nous suivons les dernières tendances afin de pouvoir offrir des produits innovants tels que des solutions pour le marché des piscines et des marches de grand format.

Компания **Exagres** предлагает широкий спектр продукции, изготовленной путем экструзии, с высокими техническими характеристиками, идеально подходящей как для внутренней, так и наружной отделки домов, в дополнение к тому, что она может использоваться для частных и общественных пространств.

С помощью процесса экструзии мы можем изготавливать изделия с заданными размерами и сложными формами, которые невозможно достичь путем прессования, что позволяет нам предлагать универсальные решения для комплексной и однородной отделки с одним и тем же видом керамического материала.

Все это в сочетании с технологией цифровой печати, которая позволяет наносить любые изображения на керамическую плитку, начиная от рельефных текстур и заканчивая различными цветовыми решениями выпускаемых нами изделий, позволяет компании Exagres предлагать уникальную высококачественную продукцию как с технической, так и эстетической точки зрения.

Основной задачей компании Exagres является удовлетворение потребностей клиентов, поэтому мы всегда следим за последними тенденциями с тем, чтобы предлагать инновационную продукцию как крупноформатные ступени и изделия для бассейнов.

PELDAÑOS /

STEPS · MARCHES · СТУПЕНИ

PELDAÑO FIORENTINO 33 x 33 x 3 cm

CARTABÓN FIORENTINO 33 x 33 x 3 cm

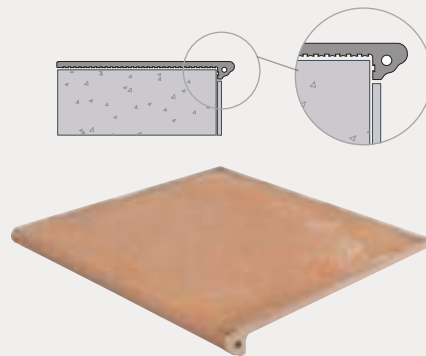

PELDAÑO ML 24,5 x 33 x 4 cm / 33 x 33 x 4 cm

CARTABÓN ML 33 x 33 x 4 cm

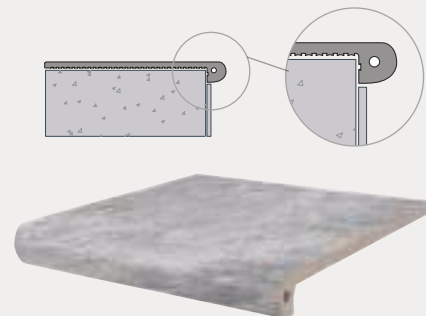

PELDAÑO RECTO 33 x 33 x 3 cm

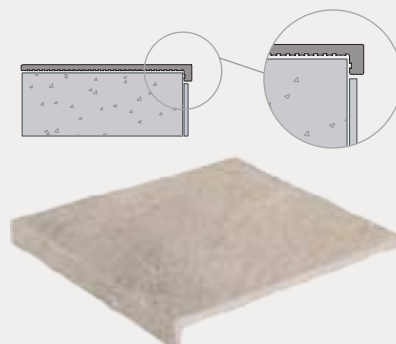

PELDAÑOS 120 /

STEP 120 · MARCHE 120 · Ступень 120 см

El peldaño 120 es un avance como solución constructiva, que se adapta a las necesidades del mercado actual, evitando cortes y juntas.

Step 120 is an advance as a constructive solution, which adapts to the needs of the current market, avoiding cuts and joints

La marche 120 représente un progrès comme solution de construction, qui s'adapte aux besoins du marché actuel, en évitant les coupures et les jointures.

Ступень 120 см является шагом вперед в качестве конструктивного решения, что отвечает потребностям современного рынка и позволяет предотвратить резку плитки и образование швов.

PELDAÑO 120 FIORENTINO

33 x 120 x 3 cm

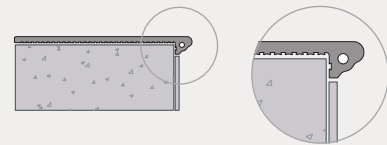
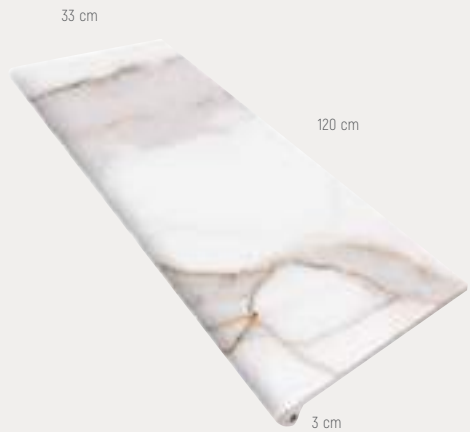

MARBLES 33 x 120 x 3 cm

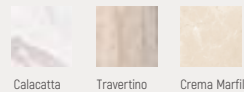

KIOTO 33 x 120 x 3 cm

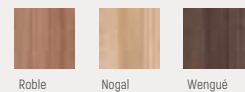

PELDAÑO 120 RECTO

33 x 120 x 3 cm / 33 x 60 x 3 cm

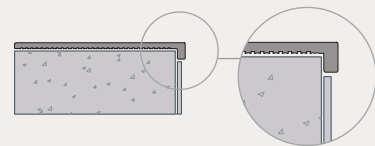

MARBLES 33 x 120 x 3 cm - 33 x 60 x 3 cm

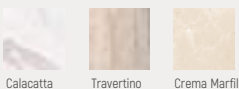

MARKINA 33 x 120 x 3 cm



*sólo markina bianco

KIOTO 33 x 120 x 3 cm

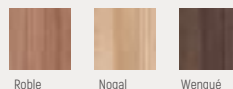

YOHO 33 x 120 x 3 cm

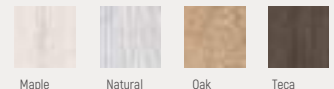

LITOS 33 x 120 x 3 cm

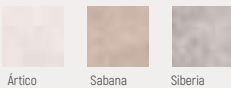

ALBAROC 33 x 120 x 3 cm

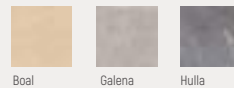

MILÁN 33 x 120 x 3 cm

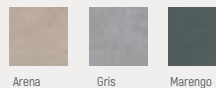

ÓPERA 33 x 120 x 3 cm



REMATE PELDAÑO 120 /

STEP 120 · MARCHE 120 · Ступень 120 см



REMATE PELDAÑO FIORENTINO DCHA./IZDA. 3 x 33 cm



MARBLES 3 x 33 cm

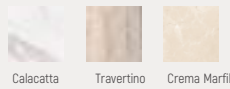

Calacatta

Travertino

Crema Marfil

KIOTO 3 x 33 cm

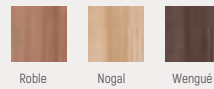

Roble

Nogal

Wengué

REMATE PELDAÑO RECTO 3 x 33 cm



MARBLES 3 x 33 cm

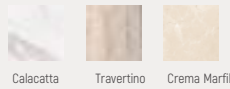

Calacatta

Travertino

Crema Marfil

MARKINA 3 x 33 cm

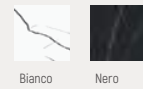

Bianco

Nero

KIOTO 3 x 33 cm

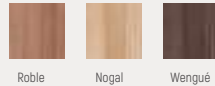

Roble

Nogal

Wengué

YOHO 3 x 33 cm

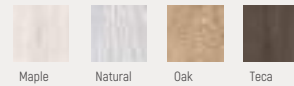

Maple

Natural

Oak

Teca

LITOS 3 x 33 cm

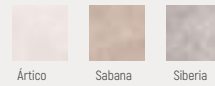

Ártico

Sabana

Siberia

ALBAROC 3 x 33 cm

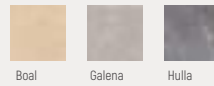

Boal

Galena

Hulla

MILÁN 3 x 33 cm

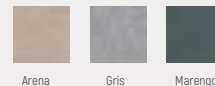

Arena

Gris

Marengo

ÓPERA 3 x 33 cm

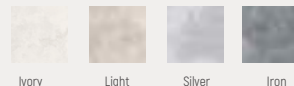

Ivory

Light

Silver

Iron



A - PELDAÑO RECTO 120 33 x 120 x 3 cm
 B - REMATE PELDAÑO RECTO 3 x 33 cm
 C - TABICA 14,5 x 120 cm
 D - ZANQUÍN RECTO IZDA. 18 x 40 cm

ZANQUINES /

SKIRTING BOARD · PLINTE · Лестничный плинтус

ZANQUÍN FIORENTINO IZDA./DCHA.
39,5 x 17,5 cm

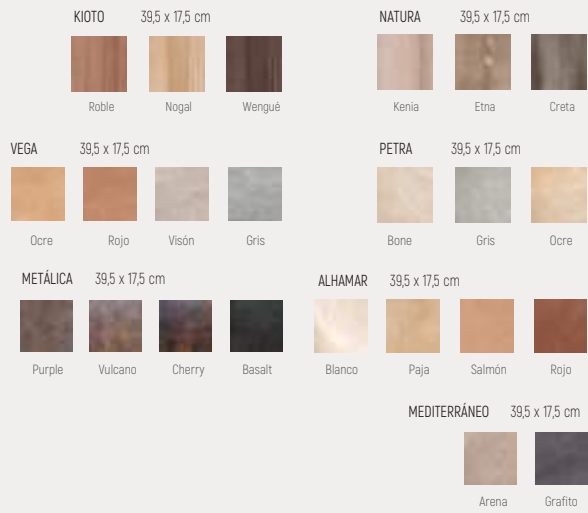

ZANQUÍN ML IZDA./DCHA.
39,5 x 17,5 cm



ZANQUÍN RECTO IZDA./DCHA.
42,3 x 17,5 cm

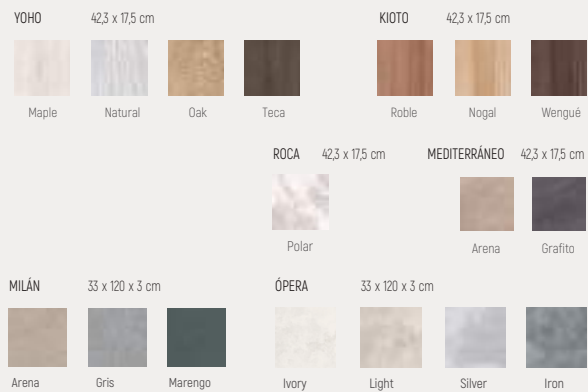

ZANQUINES 18x40 /

SKIRTING BOARD · PLINTHE · Лестничный плинтус



ZANQUÍN RECTO IZDA./DCHA.
18 x 40 cm



LITOS 18 x 40 cm

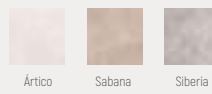

Ártico Sabana Siberia

ALBAROC 18 x 40 cm

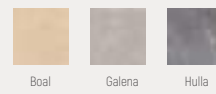

Boal Galena Hulla

MARKINA 18 x 40 cm

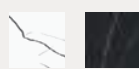

Bianco Nero

MARBLES 18 x 40 cm

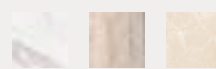

Calacatta Travertino Crema Marfil

ZANQUÍN ML IZDA./DCHA.
18 x 40 cm



ALBAROC 18 x 40 cm

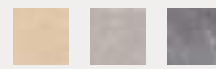

Boal Galena Hulla

ZANQUÍN FIORENTINO IZDA./DCHA.
18 x 40 cm



MARBLES 18 x 40 cm



Calacatta Travertino Crema Marfil

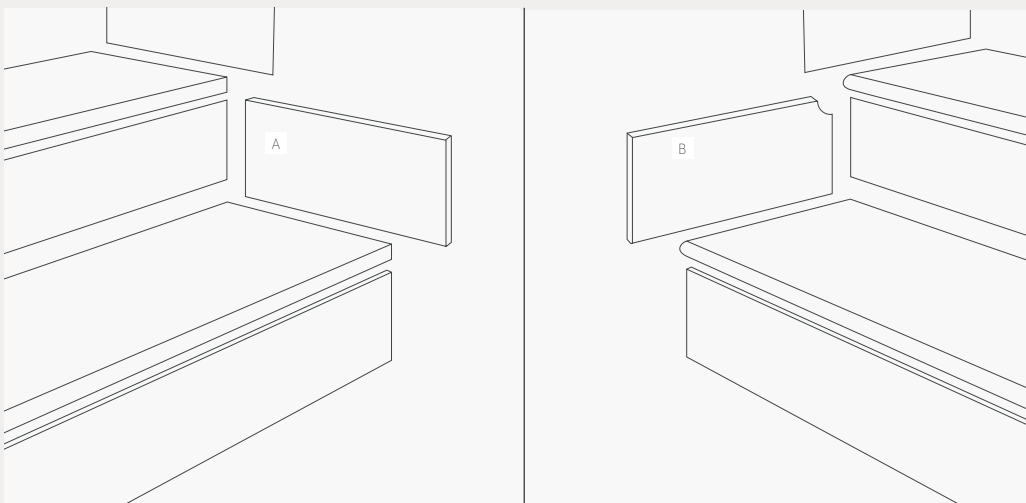

A - ZANQUÍN RECTO DCHA. 18 x 40 cm
B - ZANQUÍN ML IZDA. 18 x 40 cm

CORONACIÓN SKIMMER. SKIMMER SYSTEM

BORDE PISCINA SKIMMER. 45x75x3 cm



YOHO

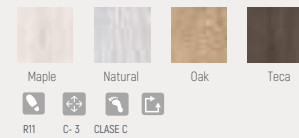

MILÁN

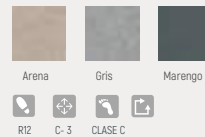

ÓPERA



BORDE PISCINA SKIMMER. 28 x 66,5 cm / 28 x 33 cm



NATURA 28 x 66,5 cm



PETRA 28 x 33 cm



LUCCA 28 x 33 cm



ÁNGULO INTERIOR. 33x33 cm



ÁNGULO EXTERIOR. 28x28 cm



BORDE PISCINA. PELDAÑO RECTO. 33 x 60 x 3 cm

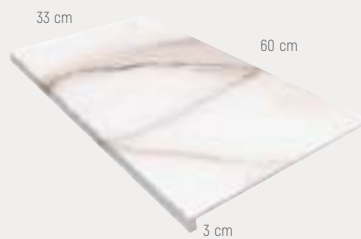

MARBLES

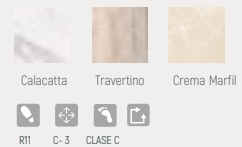

PIEZAS VASO PISCINA

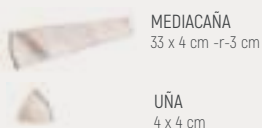

MARBLES

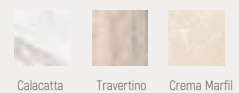

CORONACIÓN DESBORDANTE. OVERFLOW SYSTEM

BORDE DESBORDANTE. 28x66,5 cm

ÁNGULO BORDE DESBORDANTE. 33x33 cm



LITOS R12 CLASE C C-3

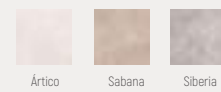

ROCA R12 CLASE C C-3



REJILLA. 24,5 x 24,5 cm

ÁNGULOS REJILLA IZDA. DCHA.



ÓPERA R12 CLASE C C-3

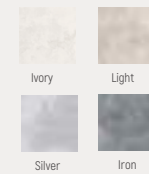

PIEZAS VASO PISCINA

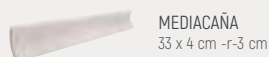

MEDIATECA
33 x 4 cm - r-3 cm



ARISTA
33 x 3 cm - r-3 cm

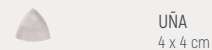

UÑA
4 x 4 cm

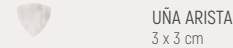

UÑA ARISTA
3 x 3 cm

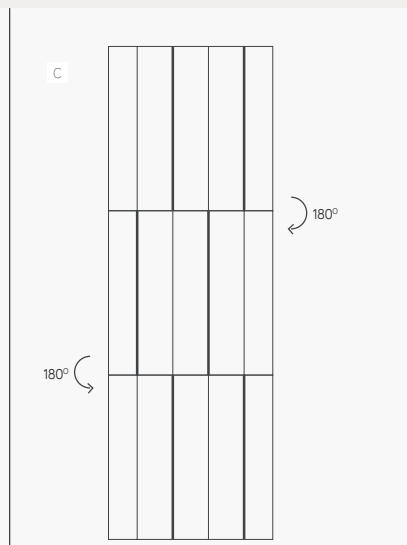
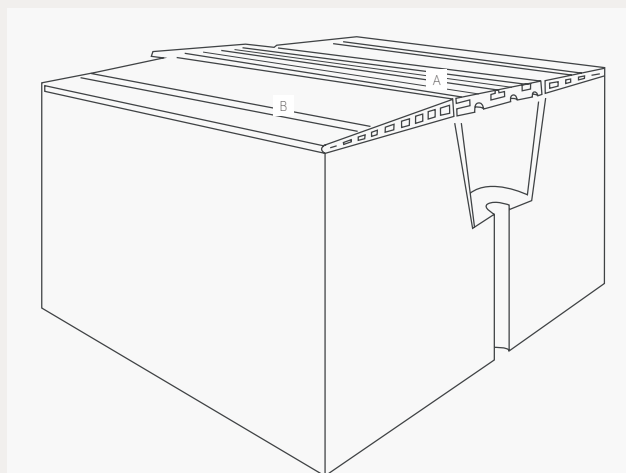
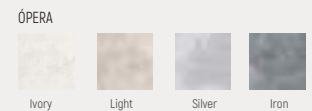
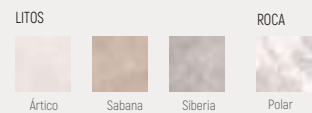

A - REJILLA 24,5 x 24,5 cm (COLOCACIÓN ALTERNADA A 180°)
B - BORDE DESBORDANTE 28 x 66,5 cm
C - REJILLA 24,5 x 24,5 cm (COLOCACIÓN ALTERNADA A 180°), VISTA CENITAL

VIERTEAGUAS /

WINDOW SILLS · APPUIE DE FENÊTRE · Подоконник

VIERTEAGUAS. 15 x 24,5 x 4 cm / 12 x 33 x 3 cm / 15 x 33 x 4 cm*

*medidas interiores. interior dimensions.

DESCRIPCIÓN · DESCRIPTION · DESCRIPTION · ОПИСАНИЕ

- Forma rectangular con borde lateral redondeado provisto de goterón. Superficie inferior ranurada en cola de milano para optimizar el agarre al soporte.
- Rectangle shape with lateral rounded edge provided with big drop. Back tile in dove tail profile to improve the hold to the slab.
- Format rectangulaire, le bord latérale arrondie avec dispositif anti-goutte. La surface inférieure fendue en queue d'aronde pour optimiser l'adhérence de l'appui.
- Элементы имеют прямоугольную форму с одним закругленным краем для облегчения дренажа. Обратная сторона элементов выполнена в форме сечения "ласточкин хвост" для надежной фиксации элемента.

APLICACIONES Y COLOCACIÓN · APPLICATIONS AND INSTALLATION · APPLICATIONS ET POSE · ПРИМЕНЕНИЕ И МОНТАЖ

- Vierendeaguas en ventanas, marquesinas, voladizos, repisas, remate superior de muros medianeros, perimetrales y cercas.
- Window Sills in windows, porches, projecting, brackets, top finishing for diving walls, perimeter walls and fences.
- Appuie pour les fenêtres, marquises, rebords, finition supérieur de murs mitoyens, des clôtures, etc.
- Данная плита укладывается как подоконник, так же подходит для отделки террас, изгородей, а так же как наружная облицовка.

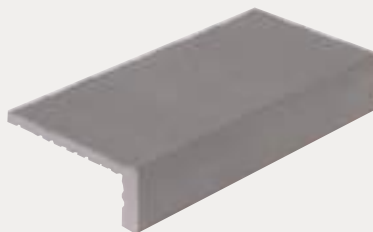

MANHATTAN

15 x 24,5 x 4 cm

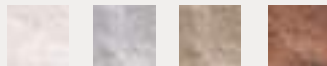

White

Grey

Mink

Red

MEDITERRÁNEO

12 x 33 x 3 cm

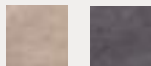

Arena

Grafito

VEGA

12 x 33 x 3 cm



Ocre

Rojo

Visón

Gris

LUCCA

15 x 33 x 4 cm

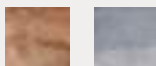

Terra

Grigio

ALHAMAR

15 x 33 x 4 cm



Blanco

Paja

Salmón

Rojo

PASAMANOS /

HANDBRAILS MAIN COURANT · COUVRE MURS · ПОРУЧНИ



PASAMANOS. 12,5 x 66,5 x 4 cm / 15,5 x 66,5 x 4 cm

*medidas interiores. interior dimensions.

DESCRIPCIÓN · DESCRIPTION · DESCRIPTION · ОПИСАНИЕ

- Forma rectangular con bordes laterales redondeados provistos de goterón, la parte superior dispone de una ligera curvatura que facilita el drenaje. Superficie interior ranurada en cola de milano para optimizar el agarre al soporte.
- Rectangle shape with lateral rounded edges provided with big drop, the top side has a slight curvature (bend) to ease the drainage. Back tile in dove tail profile to improve the hold to the stab.
- Format rectangulaire, les bords latéraux arrondis avec dispositif anti-goutte, la partie supérieure dispose d'une très légère courbature pour faciliter le drainage. Surface intérieure rainurée pour faciliter la pose sur tous types de support.
- Элементы имеют прямоугольную форму с закругленными краями по углам, верхняя сторона имеет небольшой изгиб для облегчения дренажа. Обратная сторона элементов выполнена в форме сечения "ласточкин хвост" для надежной фиксации элемента.

APLICACIONES Y COLOCACIÓN · APPLICATIONS AND INSTALLATION · APPLICATIONS ET POSE · ПРИМЕНЕНИЕ И МОНТАЖ

- Cubremuros, antepechos de terrazas, azoteas, tendederos, escaleras, pretils y coronación de cercas y muros divisorios.
- Top-wall finishing, terrace parapets, flat roofs, drying places, stairs, handrails and tops for fences and dividing walls.
- Main courante, couvre-murs, finition de murs verticales, etc.
- Используется в качестве поручней и перил лестниц. Может применяться для финишной отделки парапетов террас, плоских крыш, верхнего облицовочного элемента стенок, пергородок и т.д.



MEDITERRÁNEO



Arena Grafito

ALBAROC



Boal Galena Hulla

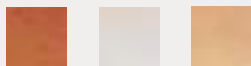

4 5 7

RECOMENDACIONES DE COLOCACIÓN

Las Series de EXAGRES, S.A. están fabricadas en gres extrusionado de baja absorción de agua, bajo la norma de producto UNE-EN 14411 Grupo Alb. Aunque el dorso de las piezas está estriado en cola de milano para aumentar la adhesión de las mismas al mortero de agarre, EXAGRES recomienda, sin excluir otros posibles métodos, la colocación de baldosas y piezas especiales con mortero adhesivo predosificado (tipo cemento-cola) de buena calidad adecuado al uso y condiciones de uso del recubrimiento cerámico. En zona de climatología severa, riesgo de heladas o colocación en exteriores o piscinas, se recomienda utilizar morteros adhesivos "tipo flexible", "especial porcelánico", "especial fachadas" o "especial piscinas" en cada caso, de un fabricante reconocido de materiales de instalación de cerámica, disponible en almacenes de materiales.

SOPORTE DE COLOCACIÓN

Deberá ser estable dimensionalmente, sano, sólido, resistente y rígido, con superficie de rugosidad suficiente. Soportes flexibles o estructuras deformables requieren una capa de desolidarización y juntas de movimiento, formatos menores y juntas de colocación más anchas.

COLOCACIÓN EN CAPA GRUESA

En caso de utilizar el sistema tradicional, recomendamos usar morteros de capa gruesa mejorados con aditivo látex para aumentar la adhesión de la capa de agarre con la cerámica de baja absorción. Existen morteros adhesivos preparados de capa media que permiten nivelar (hasta 2-3 cm.) e instalar la cerámica a la vez.

COLOCACIÓN EN CAPA FINA

Previamente hay que regularizar el soporte con una capa de mortero de nivelación. Sobre el soporte nivelado se extiende el mortero adhesivo en capa fina (TIPO C2 según norma UNE EN 12004:01), en lecho continuo, con llana dentada de tamaño adecuado. En solados exteriores se resolverán cuidadosamente las pendientes de desagüe, la impermeabilización del soporte y la confección de juntas perimetrales y juntas de partición cada 5x5 m. como máximo. La junta entre las piezas recomendada será de 5 mm, para respetar la modularidad de las series y la correspondencia de juntas entre los diferentes formatos y/o piezas especiales. **IMPORTANTE:** se respetará la dirección del ranurado posterior de las baldosas, colocándolas siempre en la misma dirección.

REJUNTADO

El rejuntado se efectuará con un material de prestaciones adecuadas a la solicitud del recubrimiento durante su uso, y se optará por un mortero preparado de cualquier fabricante reconocido, ya que ofrecen una amplia gama de colores y materiales de diferentes características. El tipo de mortero de juntas adecuado será Tipo CG2 (según UNE EN 13888) usando , en caso de requerir resistencia química materiales Tipo RG.

ASESORAMIENTO

Es conveniente contar con el asesoramiento del fabricante de materiales de instalación elegido, para que facilite información sobre prestaciones, instrucciones de uso, tiempo abierto, etc. así como procedimientos de limpieza de la instalación después de la colocación y el rejuntado.

TAREAS PREVIAS A LA COLOCACIÓN

Las baldosas se mezclarán antes de su colocación para conseguir una destonificación armónica, abriendo varias cajas de diferentes pallets, en su caso.

LIMPIEZA DE OBRA Y MANTENIMIENTO

Si después de la colocación y la primera limpieza, quedan restos de materiales cementosos sobre la superficie de la instalación, usar un limpiador cerámico o desincrustante ácido adquirido en cualquier almacén de materiales. Antes de la aplicación mojar el recubrimiento para saturar las juntas de agua y protegerlas de la acción del limpiador. Después del lavado, eliminar el producto con abundante agua limpia. Para el mantenimiento ordinario, existen productos adecuados específicos para cerámica.

PAVIMENTOS EXTERIORES

Los pavimentos exteriores se encuentran sometidos continuamente a duras condiciones atmosféricas y a la acción de heladas y choque térmicos, que pueden provocar daños irreparables en la instalación. Por ello se extremará el control de ejecución y la calidad de los materiales empleados. Se asegurará la estanqueidad de la instalación para evitar filtraciones de agua al soporte y se resolverá cuidadosamente el sellado de las juntas, entre piezas, perimetrales y de dilatación. Las juntas de dilatación y partición atravesarán el solado, la capa de agarre y la de nivelación.

RECLAMACIONES

La legislación actual requiere que las demandas sean presentadas antes de la colocación de las baldosas. De modo que no se considerarán reclamaciones sobre materiales ya colocados.

INSTALLATION SUGGESTIONS

EXAGRES, S.A. Series is a glazed and very low water absorption extruded ceramic, product norm EN 14411 Alb Group. Although the back tiles profiled in dove tail to increase the adherence to the setting mortar, EXAGRES recommend, without excluding any other possible systems, installing the tiles and special pieces with a thin set mortar method.

In outdoor places with a hard cold weather, risk of freeze or when placing in exterior wall, the use of "flexible thin set mortar" is recommended, "special porcelanic tile" or "high strength mortar" from a known manufacturer of ceramic tile installation materials, available in any building materials warehouse or tiles dealer.

INSTALLATION SLAB

Must be clean, dry, structurally sound and ensure the rough surface.

A cleavage membrane is necessary in concrete slabs with a deflection and building structures with a movement. Small sizes tiles, wide joints between tiles and movement joints are recommended.

THICK BED METHOD

In that case, use cement mortars with latex admix, for improved bond to the very low absorption tiles.

You can use medium thickness bed mortars for leveling and installing.

THIN BED METHOD

The installation system, over clean, dry structurally sound and free from any bond breaking surface, consist in placing a thin bond coat (C2 Type EN 12004:01 norm), extended continuously with notched trowel. In exteriors the water draining slopes will be carefully resolved, as well the waterproofing slab and the placing perimeter joints and expansion joints every 5x5 m.

The recommended joint between pieces will be 5 mm, to respect modularity and the correspondance of joints between different sizes and/or specials pieces.

VERY IMPORTANT we recommend setting the pieces with the back grooved in the same direction.

GROUTING

The grouting will be done by a grout that adequates its characteristics to the coating and the use of installation, choosing any grout from any known manufacturer, whose range of colours and materials are usually wider. Grout must be CG2 Type (EN 13888 norm) using grout RG Type (epoxy grout) for best chemical and stain resistance.

TECHNICAL SUPPORT

It is recommended to be advice by the chosen manufacturer in order to be technical supported about characteristics, instructions of use, open time, etc. as well as cleaning tips after installing tiles.

PREVIOUS TASKS BEFORE INSTALLATION

Before laying the tiles, mix them from several boxes and pallets, in order to ensure a uniform look and the best result.

CLEANING AND MAINTENANCE

After the installation and the first cleaning, remove the cured grout with a commercial ceramic cleaner, or acid remover from any ceramic tile installation products manufacturer. Follow the instructions of use from manufacturer. Use specific ceramic cleaners in the maintenance tasks.

EXTERIORS FLOORS

Exterior floors are submitted to several requirements and weather conditions, frost, thermal shocks, etc. which are able to cause damages.

It is essential to check the masonry works, installation method and quality of tiling materials.

Appropriate slopes, waterproofing, expansion and perimeter joints, grouting and sealing the joints, are fundamental.

COMPLAINTS

Note that current legislation requires disputes to be before installation tiles. Complaints concerning already laid materials shall not, therefore, be proposed and shall not be considered.

RECOMMANDATIONS POUR LA POSE

Les séries d'EXAGRES S.A. ont été fabriquées en gres étiré. Ce carreaux ont une absorption d'eau basse selon la norme EN 14411 Groupe Alb. Bien que la queue d'aronde du dos des carreaux serve à mieux les adhérer au mortier, Exagres conseille de placer les carreaux et pièces spéciales à l'aide d'un mortier adhésif prédosé (genre ciment-colle) de bonne qualité et approprié aux possibles domaines d'application des carreaux.

SUPPORT

Le support doit être solide, résistant, rigide et suffisamment rugueux. Les supports souples ou les structures déformables ont besoin d'une couche de désolidaritation; des joints de mouvement, des formats plus petits, ainsi que des joints plus larges.

POSE EN COUCHE ÉPAISSE

En ce qui concerne le système traditionnel, nous recommandons l'utilisation de mortiers à couche épaisse améliorés à base d'additif latex afin d'augmenter l'adhésion de la couche d'adhérence avec la céramique à absorption basse. Il existe des mortiers adhésifs à couche moyenne déjà préparés qui permettent de niveler (jusqu'à 2-3 cm) et installer les carreaux au même temps.

POSE EN COUCHE MINCE

Premièrement il faut régulariser le support à l'aide d'une couche de mortier de nivellement. Sur le support nivelé il faut étendre le mortier adhésif en couche mince (TYPE C2 selon UNE EN 12004 :01) et continuer avec une truelle dentée. Quant aux surfaces extérieures il faut faire attention aux pentes de drainage, à l'imperméabilisation du support. Nous recommandons faire des joints de dilatation tous les 5x5 m au maximum. Les joints entre les carreaux doivent avoir une largeur de 5 mm afin de respecter la modularité des différentes séries.

ATTENTION: il est conseillé de poser les carreaux de façon à ce que la queue d'aronde suive toujours la même direction.

JOINTOLEMENT

Il est conseillé d'effectuer le jointolement avec du matériel approprié au domaine possible d'application des carreaux, en choisissant un mortier d'un fabricant spécialisé, puisqu'ils offrent un grand choix de couleurs et matériaux. Le mortier pour joints le plus approprié est celui de Type CG2 (selon UNE EN 13888). Nous recommandons le matériel du Type RG pour obtenir une résistance aux produits chimiques complémentaire.

SUGGESTION: Il est recommandable de se faire conseiller par le fabricant du matériel choisi par rapport aux caractéristiques, mode d'emploi, temps d'ouverture. Également il peut vous conseiller sur le nettoyage du sol après la pose des carreaux.

RECOMMANDATIONS AVANT LA POSE

Pour que la surface totale de carrelage ait une détonification harmonique, nous conseillons de mélanger des carreaux de différentes boîtes.

NETTOYAGE ET ENTRETIEN

Dans le cas où il resterait des traits de mortier sur la surface d'installation, il faudrait utiliser un produit spécifique pour la céramique ou, autrement, un produit désincrustant. Premièrement il est conseillé de mouiller la surface à nettoyer avec l'objectif de remplir les joints d'eau et les protéger de l'action du produit nettoyant. Une fois le nettoyant appliqué, il faut rincer avec d'eau propre. Pour ce qui concerne l'entretien ordinaire, il existe des produits spécifiques pour la céramique.

REVÊTEMENTS À L'EXTÉRIEUR

Les carreaux posés à l'extérieur peuvent souffrir les effets des chocs thermiques, des gelées, etc, ce qui peut endommager l'installation. De ce fait il faut absolument faire attention aux travaux de pose du carrelage, ainsi qu'à la qualité des matériaux y utilisés. Il faut éviter les filtrations d'eau dans le support. Il faut également faire attention à bien sceller tous les joints.

RÉCLAMATIONS

Selon la loi actuelle aucune réclamation ne sera prise en compte après la pose des carreaux céramiques. Une fois les carreaux placés, les réclamations ne seront pas prises en compte.

РЕКОМЕНДАЦИИ ПО УКЛАДКЕ КЕРАМИЧЕСКОЙ ПЛИТКИ И СПЕЦИАЛЬНЫХ ЭЛЕМЕНТОВ



РЕКОМЕНДАЦИИ ПО УКЛАДКЕ КЕРАМИЧЕСКОЙ ПЛИТКИ И СПЕЦИАЛЬНЫХ ЭЛЕМЕНТОВ EXAGRES

Все коллекции фабрики EXAGRES, S.A. произведены по технологии экструдированного клинкера. Керамическая плитка и элементы EXAGRES имеют низкое водопоглощение в соответствии с нормативом EN 14411 Группа Iib.

ОБЩИЕ РЕКОМЕНДАЦИИ

Технология подготовки оснований и укладки керамической плитки, а также специальных элементов должна соответствовать строительным правилам и нормам вашего региона.

При использовании материалов необходимо тщательно следовать рекомендациям и правилам применения Производителей данных материалов

НАПОЛЬНАЯ ПЛИТКА ДЛЯ НАРУЖНОГО ПРИМЕНЕНИЯ

Внешние покрытия всегда подвергаются воздействию погодных условий, мороза, перепадов температуры, что может послужить причиной деформации укладки. Поэтому, рекомендуем Вам контролировать процесс укладки и качество используемых материалов и растворов.

Основание должно быть должным образом усилено арматурой и гидроизолировано, чтобы избежать протечек воды.

Рекомендуется хорошо заполнять швы между плитками, компенсационные швы и швы по периметру, примыкающие к стенам здания. Компенсационные швы должны полностью пересекать все основание.

ОСНОВАНИЕ, НА КОТОРУЮ БУДЕТ УКЛАДЫВАТЬСЯ ПЛИТКА

Основание, на которую будет укладываться плитка должна быть идеально ровное, прочное, устойчивое и твердое. Поверхность основания должна быть достаточно шероховатой.

При необходимости, при наружных работах, основание должно быть гидроизолировано.

Плитка и ступени на наружных площадках и лестницах должны быть уложены под определенным углом, для избегания застаивания воды

КЛЕЕВЫЕ СМЕСИ

EXAGRES рекомендует, укладывать облицовочную плитку с использованием качественных клеевых цементных смесей, отвечающим требованиям эксплуатации плитки.

Для укладки плитки в бассейнах, в местах с контрастным климатом, а также при наружных работах, рекомендуется использовать профессиональные клеевые смеси, пригодные для реальных условий эксплуатации, например:

- специальный для наружных работ
- специальный для керамогранита
- специальный для фасадов
- специальный для бассейнов
- специальный для клинкера

Клеевые смеси, которые будут использоваться для укладки плитки EXAGRES, должны быть пригодны для приклейки плитки с низким коэффициентом водопоглощения, согласно рекомендациям производителя клеевой смеси

УКЛАДКА В ТОЛСТОМ СЛОЕ

При укладке плитки с одновременным выравниванием основания, а также при толщине плиточного клея до 2-3 см, рекомендуется специальный клей для толстого слоя с латексными добавками.

УКЛАДКА В ТОНКОМ СЛОЕ

Прежде чем наносить слой клея, требуется выровнять основание.

Клеевая смесь наносится зубчатым шпателем на ровное основание тонким слоем

УКЛАДКА ПЛИТКИ

EXAGRES рекомендует перед укладкой плитки и ступеней, вынуть ее из всех коробок и тщательно перемешать между собой, для того чтобы достичь гармоничной разнотонности.

Укладка плитки осуществляется по направлению полос, которые находятся на задней стороне плитки и элементов

КОМПЕНСАЦИОННЫЙ ШОВ РАСШИРЕНИЯ

При укладке плитки на подвижные основания, которые могут деформироваться в процессе эксплуатации требуется предусмотреть компенсационный шов расширения между рядами плитки. Компенсационный шов расширения рекомендуется делать каждые 5x5 м, а также в местах примыкания площадок к стенам зданий. Ширина шва должна быть не меньше 5 мм. Шов расширения должен быть заполнен эластичным наполнителем.

ЗАТИРКА

Затирочный раствор для швов, выбирается в зависимости от условий дальнейшей эксплуатации настеленной поверхности. При укладке снаружи затирка может быть сделана влагостойкой с помощью специальных добавок.

ОКОНЧАТЕЛЬНАЯ ЧИСТКА И УХОД

После укладки плитки для удаления цементного налета рекомендуется использовать специальное средство для снятия налета, которые имеются у поставщиков клеевой смеси.

Перед использованием средства для удаления налета необходимо намочить швы водой, для того, чтобы их защитить.

После очистки требуется окончательно смыть средство водой из шланга или аппарата высокого давления

Для регулярной чистки рекомендуется использование подходящего для керамики средства.

PROCESO DE EXTRUSIÓN /

EXTRUSION PROCESS

La **extrusión** es una técnica de conformado para la fabricación de productos cerámicos.

Básicamente el proceso de extrusión consiste en forzar el paso, mediante la aplicación de presión, de la pasta con consistencia plástica a través de una matriz.

La fabricación de baldosas mediante el proceso de extrusión consta de cuatro fases principales: amasado, conformado, secado y cocción.

- el amasado consiste en el mezclado con agua de las materias primas previamente preparadas y molidas. Con esto se consigue una pasta fácilmente moldeable por extrusión.

- en el conformado se realiza introduciendo la masa plástica en la extrusora, y con presión de vacío es amasada y empujada a través de la boquilla para obtener las piezas finales.

Con este proceso se pueden obtener piezas especiales como peldaños o bordes piscinas, etc...

- después las piezas ya moldeadas son sometidas a aire caliente para eliminar el contenido de humedad.

- posteriormente son cocidas a altas temperaturas, obteniendo una perfecta vitrificación de las mismas.

Con este proceso los materiales pueden ser reciclados en su totalidad y admiten hasta un 45% de materiales reciclados en su proceso estándar.

Extrusion is a shaping technique for the manufacture of ceramic products.

Basically, the extrusion process consists of forcing the passage, through the use of pressure, of a paste with plastic consistency through a grid.

The manufacture of tiles through the extrusion process consists of four main phases: kneading, shaping, drying and firing.

- The kneading consists of mixing the previously prepared and milled raw materials with water. This results in a paste that is easily malleable by extrusion.

- The shaping is carried out by placing the plastic paste in the extruder, which is kneaded and pushed through the nozzle by vacuum pressure in order to obtain the final pieces.

This process results in special pieces such as steps or pool edging, etc.

- Later, the moulded pieces are subjected to hot air in order to eliminate any humidity.

- They are then fired at high temperatures, obtaining perfect vitrification of the same.

With this process, the materials can be fully recycled and accept up to 45% of recycled material in their standard process.

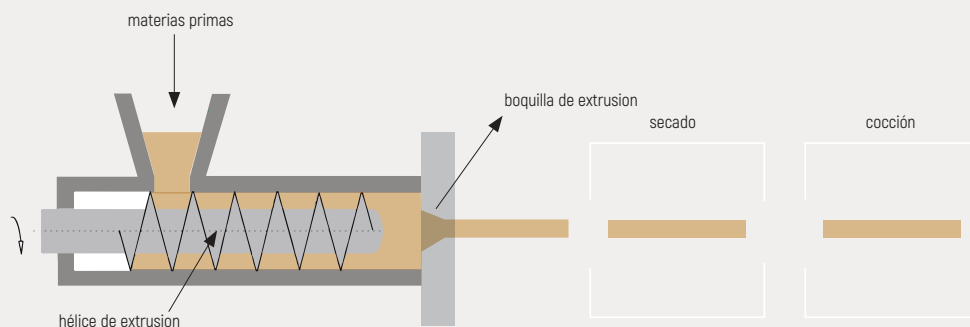

PROCESO DE EXTRUSIÓN - EXTRUSION PROCESS

L'extrusion est une technique de mise en forme pour la fabrication de produits en céramique.

Le procédé d'extrusion consiste essentiellement à forcer le passage, à travers l'application d'une pression, de la pâte à consistance plastique à travers une matrice.

La fabrication de carreaux par le procédé d'extrusion se compose de quatre phases principales : malaxage, mise en forme, séchage et cuisson.

- le malaxage consiste à mélanger avec de l'eau les matières premières qui ont été préalablement préparées et moulues. Grâce à cela, on obtient une pâte que l'on peut facilement mouler par extrusion.

- la mise en forme se réalise en introduisant la pâte plastique dans une machine à extrusion. Cette pâte, sous la pression du vide, est malaxée et poussée à travers une filière pour obtenir les pièces finales.

Grâce à ce procédé, il est possible d'obtenir des pièces spéciales comme des marches ou des margelles de piscines, etc.

- ensuite, les pièces déjà moulues sont passées à l'air chaud afin d'éliminer le contenu d'humidité.

- puis, elles sont cuites à hautes températures, ce qui permet d'obtenir de ces dernières une parfaite vitrification.

Grâce à ce procédé, les matériaux peuvent être recyclés dans leur totalité et permettent jusqu'à 45 % de matériaux recyclés dans leur procédé standard.

Экструзия – технология, используемая для формовки керамических изделий при их изготовлении.

В основном процесс экструзии заключается в продавливании под давлением пастообразного сырья через формирующее отверстие.

Производство керамической плитки с помощью экструзии состоит из четырех основных этапов: замеса, формовки, сушки и обжига.

– Замес заключается в смешивании с водой предварительно подготовленного и измельченного сырья. Конечным результатом этого процесса является легко поддающаяся обработке паста для экструзии.

– Формовка представляет собой загрузку полученной при замесе пасты в экструдер, в котором она перемешивается под вакуумным давлением и проталкивается через сопло для формовки конечных изделий.

С помощью этого процесса можно получить специальные изделия, такие как ступени или бордюры для бассейнов и т. д.

– После этого, уже сформованные изделия проходят обработку горячим воздухом для удаления влаги.

– Затем они подвергаются высокотемпературному обжигу до достижения ими необходимой витрификации (стеклования).

С помощью этого процесса материалы могут быть полностью переработаны. В стандартном процессе допускается использование до 45 % переработанных материалов.

EL VALOR DE LA EXTRUSIÓN

THE VALUE OF EXTRUSION · LA VALEUR DE L'EXTRUSION · Преимущества экструзии

Las materias primas seleccionadas y el cuidado proceso de producción con las tecnologías más avanzadas y la labor de nuestro equipo humano, hacen que el producto obtenido posea unas características técnicas excepcionales.

Con este proceso se pueden obtener geometrías tridimensionales en las piezas, imposibles de conseguir con el proceso de pressado tradicional.

The raw materials selected, the careful production process with the most advanced technologies, and the work of our human team mean that the product obtained has exceptional technical characteristics.

With this process, three-dimensional geometries can be obtained on the pieces which are impossible to achieve with the traditional compacting process

Les matières premières choisies, le rigoureux procédé de production qui utilise les technologies les plus avancées, ainsi que le travail de notre équipe humaine font que le produit obtenu possède des caractéristiques techniques exceptionnelles.

Grâce à ce procédé, on peut obtenir des géométries tridimensionnelles sur les pièces, impossibles à réaliser avec le procédé de pressage traditionnel.





Благодаря отборному сырью и тщательному процессу производства с использованием самых передовых технологий и работе нашего коллектива полученные изделия обладают исключительными техническими характеристиками.







Этот процесс позволяет изготавливать трехмерные изделия, что невозможно при использовании традиционного процесса прессования.

CARACTERÍSTICAS TÉCNICAS /

TECHNICAL DATA · CARACTÉRISTIQUES TECHNIQUES · ТЕХНИЧЕСКИЕ ХАРАКТЕРИСТИКИ

Gres extruido de pasta blanca de baja absorción de agua, según UNE-EN 14411, grupo Alb, esmaltado.
White body extruded stoneware with low water absorption, according to EN 14411, group Alb, glazed.

COLECCIÓN	ABSORCIÓN DE AGUA WATER ABSORPTION ABSORPTION D'EAU ВОДОПОГЛОЩЕНИЕ	RESISTENCIA A LA FLEXIÓN MODULUS OF RUPTUR RÉSISTANCE À LA FLEXION СОПРОТИВЛЕНИЕ НА ИЗГИБ	RESISTENCIA A LA ABRASIÓN (PEI) DEEP ABRASION RESISTANCE RÉSISTANCE À L'ABRASION СТОЙКОСТЬ К ИСТИРАНИЮ ПОВЕРХНОСТИ	RESISTENCIA AL CHOQUE TÉRMICO THERMAL SHOCK RESISTANCE RÉSIST. AUX VARIATIONS THERMIQUES СТОЙКОСТЬ К ТЕПЛОВЫМ ПЕРЕПАДАМ	RESISTENCIA AL CUARTEO CRACKING RESISTANCE RÉSISTANCE AU TRESSAILLAGE УСТОЙЧИВОСТЬ К РАСТРЕКИВАНИЮ
					
	ISO 10545-3	ISO 10545-4	ISO 10545-7	ISO 10545-9	ISO 10545-11
MARKINA	< 1,5%	>30 N/MM2 >1800 N	5 blanco 1 nero	garantizado guaranteed garanti Гарантированно	garantizado guaranteed garanti Гарантированно
MARBLES	< 1,5%	>30 N/MM2 >1800 N	5	garantizado guaranteed garanti Гарантированно	garantizado guaranteed garanti Гарантированно
YOHO	< 1,5%	>30 N/MM2 >1800 N	5	garantizado guaranteed garanti Гарантированно	garantizado guaranteed garanti Гарантированно
KIOTO	< 1,5%	>30 N/MM2 >1800 N	4	garantizado guaranteed garanti Гарантированно	garantizado guaranteed garanti Гарантированно
NATURA	< 1,5%	>30 N/MM2 >1800 N	4	garantizado guaranteed garanti Гарантированно	garantizado guaranteed garanti Гарантированно
ÓPERA	< 1,5%	>30 N/MM2 >1800 N	4	garantizado guaranteed garanti Гарантированно	garantizado guaranteed garanti Гарантированно
MEDITERRÁNEO	< 1,5%	>30 N/MM2 >1800 N	2 grafito 4 arena	garantizado guaranteed garanti Гарантированно	garantizado guaranteed garanti Гарантированно
MILÁN	< 1,5%	>30 N/MM2 >1800 N	4 arena / gris 3 marengo	garantizado guaranteed garanti Гарантированно	garantizado guaranteed garanti Гарантированно
ALBAROC	< 1,5%	>30 N/MM2 >1800 N	4 hulla 5 boal/galena	garantizado guaranteed garanti Гарантированно	garantizado guaranteed garanti Гарантированно







RESISTENCIA A LA HELADA FROST RESISTANCE RÉSISTANCE AU GEL МОРОЗОСТОЙКОСТЬ	RESISTENCIA A LOS AGENTES QUÍMICOS CHEMICAL RESISTANCE RÉSISTANCE AUX PRODUITS CHIMIQUES СТОЙКОСТЬ К ВОЗДЕЙСТВИЮ ХИМИКАТОВ	RESISTENCIA A LAS MANCHAS STAIN RESISTANCE RÉSISTANCE AUX TACHES УСТОЙЧИВОСТЬ К ОБРАЗОВАНИЮ ПЯТЕН	RESISTENCIA AL DESLIZAMIENTO (rampa pie calzado) ANTI-SLIP RESISTANCE (ramp) RÉSISTANCE AU GLISSEMENT (pied chaussé) СОПРОТИВЛЕНИЕ СКОЛЬЖЕНИЮ (если ходит обутым)	RESISTENCIA AL DESLIZAMIENTO (C.T.E.) ANTI-SLIP RESISTANCE RÉSISTANCE AU GLISSEMENT (C.T.E.) СОПРОТИВЛЕНИЕ СКОЛЬЖЕНИЮ (C.T.E.)	RESISTENCIA AL DESLIZAMIENTO (pie descalzo) ANTI-SLIP RESISTANCE (bare foot) RÉSISTANCE AU GLISSEMENT (pied nu) СОПРОТИВЛЕНИЕ СКОЛЬЖЕНИЮ (босые ноги)
					
ISO 10545-12	ISO 10545-13	ISO 10545-14	DIN 51130	UNE-ENV 12633:2003	DIN 51097
garantizado guaranteed garanti Гарантированно	A - LA - HA	CLASE 5	R9 normal R11 anti-slip	CLASE 1 normal CLASE 3 anti-slip	- -
garantizado guaranteed garanti Гарантированно	A - LA - HA	CLASE 5	R9 normal R11 anti-slip	CLASE 1 normal CLASE 3 anti-slip	- CLASE C
garantizado guaranteed garanti Гарантированно	A - LA - HA	CLASE 5	R9 normal R11 anti-slip	CLASE 1 normal CLASE 3 anti-slip	- CLASE C
garantizado guaranteed garanti Гарантированно	A - LA - HA	CLASE 5	R10	CLASE 1	-
garantizado guaranteed garanti Гарантированно	A - LA - HA	CLASE 5	R11	CLASE 3	CLASE C
garantizado guaranteed garanti Гарантированно	A - LA - HA	CLASE 5	R9 normal R12 anti-slip	CLASE 1 normal CLASE 3 anti-slip	- CLASE C
garantizado guaranteed garanti Гарантированно	A - LA - HA	CLASE 5	R9 normal R11 anti-slip	CLASE 1 norma CLASE 3 anti-slip	- -
garantizado guaranteed garanti Гарантированно	A - LA - HA	CLASE 5	R9 normal R12 anti-slip	CLASE 1 normal CLASE 3 anti-slip	- CLASE C
garantizado guaranteed garanti Гарантированно	A - LA - HA	CLASE 5	R10 normal R12 anti-slip	CLASE 1 normal CLASE 3 anti-slip	- CLASE C

CARACTERÍSTICAS TÉCNICAS /

TECHNICAL DATA · CARACTÉRISTIQUES TECHNIQUES · ТЕХНИЧЕСКИЕ ХАРАКТЕРИСТИКИ

Gres extruido de pasta blanca de baja absorción de agua, según UNE-EN 14411, grupo Alb, esmaltado.
White body extruded stoneware with low water absorption, according to EN 14411, group Alb, glazed.

COLECCIÓN	ABSORCIÓN DE AGUA WATER ABSORPTION ABSORPTION D'EAU ВОДОПОГЛОЩЕНИЕ	RESISTENCIA A LA FLEXIÓN MODULUS OF RUPTUR RÉSISTANCE À LA FLEXION СОПРОТИВЛЕНИЕ НА ИЗГИБ	RESISTENCIA A LA ABRASIÓN (PEI) DEEP ABRASION RESISTANCE RÉSISTANCE À L'ABRASION СТОЙКОСТЬ К ИСТИРАНИЮ ПОВЕРХНОСТИ	RESISTENCIA AL CHOQUE TÉRMICO THERMAL SHOCK RESISTANCE RÉSIST. AUX VARIATIONS THERMIQUES СТОЙКОСТЬ К ТЕПЛОВЫМ ПЕРЕПАДАМ	RESISTENCIA AL CUARTEO CRACKING RESISTANCE RÉSISTANCE AU TRESSAILLAGE УСТОЙЧИВОСТЬ К РАСТРЕКИВАНИЮ
	ISO 10545-3	ISO 10545-4	ISO 10545-7	ISO 10545-9	ISO 10545-11
LITOS	< 1,5%	>30 N/MM2 >1800 N	4	garantizado guaranteed garanti Гарантированно	garantizado guaranteed garanti Гарантированно
ROCA	< 1,5%	>30 N/MM2 >1800 N	5	garantizado guaranteed garanti Гарантированно	garantizado guaranteed garanti Гарантированно
MANHATTAN	< 1,5%	>30 N/MM2 >1300 N	4	garantizado guaranteed garanti Гарантированно	garantizado guaranteed garanti Гарантированно
PETRA	< 1,5%	>30 N/MM2 >1800 N	4	garantizado guaranteed garanti Гарантированно	garantizado guaranteed garanti Гарантированно
VEGA	< 1,5%	>30 N/MM2 >1800 N	2 rojo/rojo anti-slip 3 ocre/visón 4 ocre anti-slip/grís 5 gris anti-slip/visón anti-slip	garantizado guaranteed garanti Гарантированно	garantizado guaranteed garanti Гарантированно
LUCCA	< 1,5%	>30 N/MM2 >1800 N	4	garantizado guaranteed garanti Гарантированно	garantizado guaranteed garanti Гарантированно
ALHAMAR	< 1,5%	>30 N/MM2 >1800 N	3 rojo 4 blanco/paja/salmón	garantizado guaranteed garanti Гарантированно	garantizado guaranteed garanti Гарантированно
METÁLICA	< 1,5%	>30 N/MM2 >1800 N	3	garantizado guaranteed garanti Гарантированно	garantizado guaranteed garanti Гарантированно

RESISTENCIA A LA HELADA FROST RESISTANCE RÉSISTANCE AU GEL МОРОЗОСТОЙКОСТЬ	RESISTENCIA A LOS AGENTES QUÍMICOS CHEMICAL RESISTANCE RÉSISTANCE AUX PRODUITS CHIMIQUES СТОЙКОСТЬ К ВОЗДЕЙСТВИЮ ХИМИКАТОВ	RESISTENCIA A LAS MANCHAS STAIN RESISTANCE RÉSISTANCE AUX TACHES УСТОЙЧИВОСТЬ К ОБРАЗОВАНИЮ ПЯТЕН	RESISTENCIA AL DESLIZAMIENTO (rampa pie calzado) ANTI-SLIP RESISTANCE (ramp) RÉSISTANCE AU GLISSEMENT (pied chaussé) СОПРОТИВЛЕНИЕ СКОЛЬЖЕНИЮ (если ходит обутым)	RESISTENCIA AL DESLIZAMIENTO (C.T.E.) ANTI-SLIP RESISTANCE RÉSISTANCE AU GLISSEMENT (C.T.E.) СОПРОТИВЛЕНИЕ СКОЛЬЖЕНИЮ (C.T.E.)	RESISTENCIA AL DESLIZAMIENTO (pie descalzo) ANTI-SLIP RESISTANCE (bare foot) RÉSISTANCE AU GLISSEMENT (pied nu) СОПРОТИВЛЕНИЕ СКОЛЬЖЕНИЮ (босые ноги)
					
ISO 10545-12	ISO 10545-13	ISO 10545-14	DIN 51130	UNE-ENV 12633:2003	DIN 51097
garantizado guaranteed garanti Гарантированно	A - LA - HA	CLASE 5	R9 normal R12 anti-slip	CLASE 1 normal CLASE 3 anti-slip	- CLASE C
garantizado guaranteed garanti Гарантированно	A - LA - HA	CLASE 5	R9 normal R12 anti-slip	CLASE 1 normal CLASE 3 anti-slip	- CLASE C
garantizado guaranteed garanti Гарантированно	A - LA - HA	CLASE 5	R11	CLASE 2	-
garantizado guaranteed garanti Гарантированно	A - LA - HA	CLASE 5	R12	CLASE 3	CLASE C
garantizado guaranteed garanti Гарантированно	A - LA - HA	CLASE 5	R9 normal R10 anti-slip	CLASE 1 normal CLASE 2 anti-slip	- -
garantizado guaranteed garanti Гарантированно	A - LA - HA	CLASE 5	R9 normal R11 anti-slip	CLASE 1 normal CLASE 3 anti-slip	- CLASE C
garantizado guaranteed garanti Гарантированно	A - LA - HA	CLASE 5	R9 normal R12 anti-slip	CLASE 1 normal CLASE 3 anti-slip	- -
garantizado guaranteed garanti Гарантированно	A - LB - HB	CLASE 5	R9	CLASE 1	-

CARACTERÍSTICAS TÉCNICAS











TECHNICAL DATA · CARACTÉRISTIQUES TECHNIQUES · ТЕХНИЧЕСКИЕ ХАРАКТЕРИСТИКИ

Gres Porcelánico de pasta blanca, según UNE-EN 14411; Grupo Bla, esmaltado.

White body porcelain tile, according to EN 14411, group Bla, glazed.

Grès cérame à pâte blanche, selon la norme EN 14411, Groupe Bla, émaillé.

Керамогранит из белой глины, в соответствии с EN 14411; группа Bla, глазурованныйный.

NORMA · TEST	DESCRIPCIÓN · DESCRIPTION	REQUISITOS · STANDARDS	ÓPERA bases 120x120 - 60x120 - 14,5x120	MILÁN bases 75x75 - 14,5x120
ISO 10545-2	 Dimensiones / Sizes Longitud y anchura / Length and width Espesor / Thickness Rectitud de los lados / Straightness of sides Ortogonalidad / Rectangularity Planaridad / Surface Flatness	± 0,6% ± 5% ± 0,5% ± 0,5% ± 0,5%	garantizado / guaranteed	garantizado / guaranteed
ISO 10545-3	 Absorción de agua / Water absorption	< 0,5 %	< 0,5 %	< 0,5 %
ISO 10545-4	 Fuerza de rotura / Breaking strength	≥ 1300 N	> 2800 N	> 2800 N
ISO 10545-4	 Resistencia a la flexión / Modulus of rupture	≥ 35 N/mm ²	> 45 N/mm ²	> 45 N/mm ²
ISO 10545-7	 Resistencia a la abrasión superficial / Resistance to surface abrasion	1-5	-	-
ISO 10545-9	 Resistencia al choque térmico / Resistance to thermal shock	exigida / required	garantizado / guaranteed	garantizado / guaranteed
ISO 10545-11	 Resistencia al cuarteo / Crazing resistance	exigida / required	garantizado / guaranteed	garantizado / guaranteed
ISO 10545-12	 Resistencia a la helada / Frost resistance	exigida / required	garantizado / guaranteed	garantizado / guaranteed
ISO 10545-13	 Resistencia a los agentes químicos / Chemical resistance	mínimo B minimum B	A/LA/HA	A/LA/HA
ISO 10545-14	 Resistencia a las manchas / Stain resistance	mínimo clase 3 / minimum class3	clase 5 / class 5	clase 5 / class 5
UNE-ENV 12633:2003	 Resistencia al deslizamiento (péndulo) / Slip Resistance (pendulum)	-	Normal - clase 1 / class 1 Anti-slip - clase 3 / class 3	Normal - clase 1 / class 1 Anti-slip - clase 3 / class 3

MARBLES bases 60x120 - 14,5x120	KIOTO bases 20x120 - 14,5x120	ALBAROC bases 100x100 - 14,5x120	LITOS bases 100x100 - 60x120 - 14,5x120	MARKINA bases 100x100 - 60x120 - 14,5x120	YOHO bases 25x150 - 14,5x120
garantizado / guaranteed	garantizado / guaranteed	garantizado / guaranteed	garantizado / guaranteed	garantizado / guaranteed	garantizado / guaranteed
< 0,5 %	< 0,5 %	< 0,5 %	< 0,5 %	< 0,5 %	< 0,5 %
> 2800 N	> 2800 N	> 2800 N	> 2800 N	> 2800 N	> 2800 N
> 45 N/mm2	> 45 N/mm2	> 45 N/mm2	> 45 N/mm2	> 45 N/mm2	> 45 N/mm2
5	4	4 hulla 5 boal / galena	4	5	5
garantizado / guaranteed	garantizado / guaranteed	garantizado / guaranteed	garantizado / guaranteed	garantizado / guaranteed	garantizado / guaranteed
garantizado / guaranteed	garantizado / guaranteed	garantizado / guaranteed	garantizado / guaranteed	garantizado / guaranteed	garantizado / guaranteed
garantizado / guaranteed	garantizado / guaranteed	garantizado / guaranteed	garantizado / guaranteed	garantizado / guaranteed	garantizado / guaranteed
A/LA/HA	A/LA/HA	A/LA/HA	A/LA/HA	A/LA/HA	A/LA/HA
clase 5 / class 5	clase 5 / class 5	clase 5 / class 5	clase 5 / class 5	clase 5 / class 5	clase 5 / class 5
clase 1 / class 1	clase 1 / class 1	Normal - clase 1 / class 1 Anti-slip - clase 3 / class 3	Normal - clase 1 / class 1 Anti-slip - clase 3 / class 3	Normal - clase 1 / class 1 Anti-slip - clase 3 / class 3	Normal - clase 1 / class 1 Anti-slip - clase 3 / class 3

MARBLE

MARKINA	MEDICIONES · MESSUREMENTS · MESURE · ШТУКИ/ м	CAJAS · BOXES · BOITES · КОРОБКИ	PALETS · PALLETS · PALLETES · ПАЛЛЕТЫ	MEDIDAS DE FABRICACIÓN· MANUFACTURING MEASURES
Base 100x100 cm - 11 mm (bianco)	1 pcs / m ²	1 pcs. / 25 Kg	48 boxes / 1.200 Kg	-
Base 60x120 cm - 10,2 mm (bianco)	1,39 pcs / m ²	2 pcs. / 36,5 Kg	27 boxes / 987 Kg	60x120 cm
Base 14,5x120 cm - 10,2 mm (bianco)	5,56 pcs / m ²	4 pcs. / 18,48 Kg	64 boxes / 1.195 Kg	14,5x120 cm
Base 60x120 cm - 11,3 mm (nero)	1,39 pcs / m ²	2 pcs. / 38,5 Kg	27 boxes / 1.040 Kg	59,8x119,8 cm
Base 14,5x120 cm - 11,3 mm (nero)	5,56 pcs / m ²	4 pcs. / 18,48 Kg	64 boxes / 1.195 Kg	14,5x119,8 cm
Peldaño recto 33x120x3 cm - 12 mm	0,83 pcs / ml	2 pcs. / 25,90 Kg	11 boxes / 285 Kg	-
Remate peldaño recto 3x33 cm	-	20 pcs. / 3,2 Kg	82 boxes / 263 Kg	-
Zanquin recto izda/dcha 18x40 cm	-	6 pcs. / 15 Kg	57 boxes / 855 Kg	-
Rodapié 9x40 cm	2,5 pcs / ml	12 pcs. / 15 Kg	57 boxes / 855 Kg	-

MARBLES	MEDICIONES · MESSUREMENTS · MESURE · ШТУКИ/ м	CAJAS · BOXES · BOITES · КОРОБКИ	PALETS · PALLETS · PALLETES · ПАЛЛЕТЫ	MEDIDAS DE FABRICACIÓN· MANUFACTURING MEASURES
Base 60x120 cm - 10,2 mm	1,39 pcs / m ²	2 pcs. / 36,5 Kg	27 boxes / 987 Kg	-
Base 14,5x120 cm - 10,2 mm	5,56 pcs / m ²	4 pcs. / 18,48 Kg	64 boxes / 1.195 Kg	-
Base 33x66,5 cm - 10 mm	4,5 pcs. / m ²	5 pcs. / 25,58 Kg	40 boxes / 1.015 Kg	-
Peldaño recto 33x120x3 cm - 12 mm	0,83 pcs / ml	2 pcs. / 25,90 Kg	11 boxes / 285 Kg	-
Peldaño fiorentino 33x120x3 cm - 12 mm	0,83 pcs / ml	2 pcs. / 25,90 Kg	11 boxes / 285 Kg	-
Peldaño recto 33x60x3 cm - 12 mm	1,66 pcs / ml	2 pcs. / 11,70 Kg	20 boxes / 234 Kg	-
Remate peldaño recto 3x33 cm	-	20 pcs. / 3,2 Kg	82 boxes / 263 Kg	-
Remate peldaño fiorentino 3x33 cm	-	20 pcs. / 3,2 Kg	82 boxes / 263 Kg	-
Zanquin recto izda/dcha 18x40 cm	-	6 pcs. / 15 Kg	57 boxes / 855 Kg	-
Zanquin fiorentino izda/dcha 18x40 cm	-	6 pcs. / 15 Kg	57 boxes / 855 Kg	-
Media caña 33x4 cm	3 pcs / ml	52 pcs. / 13 Kg	64 boxes / 832 Kg	-
Arista 33x3 cm	3 pcs / ml	70 pcs. / 13 Kg	64 boxes / 832 Kg	-
Uña 4x4 cm	-	4 pcs. / 0,4 Kg	72 boxes / 30 Kg	-
Uña arista 3x3 cm	-	4 pcs. / 0,4 Kg	72 boxes / 30 Kg	-
Rodapié 9x40 cm	2,5 pcs / ml	12 pcs. / 15 Kg	57 boxes / 855 Kg	-

EMBALAJE /

PACKING · EMBALLAGE · УПАКОВКА

exagres

TECHNICAL SOLUTIONS

WOOD

YOHO	MEDICIONES · MEASUREMENTS · MESURE · ШТУКИ/ m	CAJAS · BOXES · BOITES · КОРОБКИ	PALETS · PALLETS · PALLETES · ПАЛЛЕТЫ	MEDIDAS DE FABRICACIÓN · MANUFACTURING MEASURES
Base 25x150 cm - 11 mm	2,67 pcs / m ²	3 pcs. / 29,25 Kg	42 boxes / 1.230 Kg	24,5x150 cm
Base 14,5x120 cm - 10,2 mm	5,56 pcs / m ²	4 pcs. / 18,48 Kg	64 boxes / 1.195 Kg	-
Base 16,25x66,5 cm - 10 mm	9 pcs. / m ²	10 pcs. / 25,30 Kg	40 boxes / 1.012 Kg	-
Peldaño recto 33x120x3 cm - 12 mm	0,83 pcs / ml	2 pcs. / 25,90 Kg	11 boxes / 285 Kg	-
Remate peldaño recto 3x33 cm	-	20 pcs. / 3,2 Kg	82 boxes / 263 Kg	-
Zanquín recto izda/dcha 42,3x17,5 cm	-	14 pcs. / 10,0 Kg	54 boxes / 540 Kg	-
Rodapié 9x60 cm	1,66 pcs / ml	18 pcs. / 19,80 Kg	42 boxes / 840 Kg	-
Borde piscina 45x75 cm	1,33 pcs. / ml	2 pcs. / 30 Kg	29 boxes / 870 Kg	-

KIOTO	MEDICIONES · MEASUREMENTS · MESURE · ШТУКИ/ m	CAJAS · BOXES · BOITES · КОРОБКИ	PALETS · PALLETS · PALLETES · ПАЛЛЕТЫ	MEDIDAS DE FABRICACIÓN · MANUFACTURING MEASURES
Base 20x120 cm - 10,2 mm	4,17 pcs / m ²	5 pcs. / 30,65 Kg	36 boxes / 1.115 Kg	19,7x120 cm
Base 14,5x120 cm - 10,2 mm	5,56 pcs / m ²	4 pcs. / 18,48 Kg	64 boxes / 1.195 Kg	-
Peldaño fiorentino 33x120x3 cm - 12 mm	0,83 pcs / ml	2 pcs. / 25,90 Kg	11 boxes / 285 Kg	-
Peldaño recto 33x120x3 cm - 12 mm	0,83 pcs / ml	2 pcs. / 25,90 Kg	11 boxes / 285 Kg	-
Remate peldaño fiorentino 3x33 cm	-	20 pcs. / 3,2 Kg	82 boxes / 263 Kg	-
Remate peldaño recto 3x33 cm	-	20 pcs. / 3,2 Kg	82 boxes / 263 Kg	-
Zanquín fiorentino izda/dcha 39,5x17,5 cm	-	14 pcs. / 10,0 Kg	54 boxes / 540 Kg	-
Zanquín recto izda/dcha 42,3x17,5 cm	-	14 pcs. / 10,0 Kg	54 boxes / 540 Kg	-
Rodapié 9x60 cm	1,66 pcs / ml	18 pcs. / 19,80 Kg	42 boxes / 840 Kg	-

NATURA	MEDICIONES · MEASUREMENTS · MESURE · ШТУКИ/ m	CAJAS · BOXES · BOITES · КОРОБКИ	PALETS · PALLETS · PALLETES · ПАЛЛЕТЫ	MEDIDAS DE FABRICACIÓN · MANUFACTURING MEASURES
Base 16,25x66,5 cm - 10 mm	9 pcs. / m ²	10 pcs. / 25,30 Kg	40 boxes / 1.012 Kg	
Rodapié 9x33 cm	3 pcs. / ml	24 pcs. / 13,92 Kg	72 boxes / 1.002 Kg	
Peldaño Fiorentino 33x33x3 cm - 12 mm	3 pcs. / ml	4 pcs. / 12,49 Kg	56 boxes / 700 Kg	
Cartabón Fiorentino 33x33x3 cm - 14 mm	-	1 pcs. / 4,00 Kg	92 boxes / 368 Kg	
Zanquín Fiorent. izda/dcha 39,5x17,5 cm	-	14 pcs. / 10,00 Kg	54 boxes / 540 Kg	
Borde piscina 28x66,5 cm	1,5 pcs. / ml	1 pcs. / 10,75 Kg	72 boxes / 774 Kg	
Ángulo Interior 33x33 cm	-	1 pcs. / 4,80 Kg	92 boxes / 441 Kg	
Ángulo exterior 28x28 cm	-	1 pcs. / 4,00 Kg	92 boxes / 368 Kg	

URBAN

ÓPERA	MEDICIONES · MESSUREMENTS · MESURE · ШТУКИ/ m	CAJAS · BOXES · BOITES · КОРБОКИ	PALETS · PALLETS · PALLETES · ПАЛЛЕТЫ	MEDIDAS DE FABRICACIÓN · MANUFACTURING MEASURES
Base 120x120 cm - 10 mm	0,69 pcs / m ²	1 pcs. / 34,35 Kg	38 boxes / 1.306 Kg	119,8x119,8 cm
Base 60x120 cm - 11,3 mm	1,39 pcs / m ²	2 pcs. / 38,50 Kg	27 boxes / 1.040 Kg	59,8x119,8 cm
Base 14,5x120 cm - 11,3 mm	5,56 pcs / m ²	4 pcs. / 17,20 Kg	64 boxes / 1.100 Kg	14,5x119,8 cm
Base 33x66,5 cm - 10 mm	4,5 pcs. / m ²	5 pcs. / 25,38 Kg	40 boxes / 1.015 Kg	-
Peldaño recto 33x120x3 cm - 12 mm	0,83 pcs / ml	2 pcs. / 25,90 Kg	11 boxes / 285 Kg	-
Remate peldaño recto 3x33 cm	-	20 pcs. / 3,2 Kg	82 boxes / 263 Kg	-
Zanquín recto izda./dcha 42,3x17,5 cm	-	14 pcs. / 10,0 Kg	54 boxes / 540 Kg	-
Rodapié 9x60 cm	1,66 pcs / ml	18 pcs. / 19,80 Kg	42 boxes / 840 Kg	-
Borde piscina 45x75 cm	1,33 pcs. / ml	2 pcs. / 30 Kg	29 boxes / 870 Kg	-
Borde desbordante 28x66,5 cm	1,5 pcs. / ml	2 pcs. / 13,60 Kg	72 boxes / 980 Kg	-
Ángulo borde desbordante 33x33 cm	-	1 pcs. / 4,30 Kg	92 boxes / 396 Kg	-
Rejilla 24,5x24,5 cm	4 pcs. / ml	6 pcs. / 15,78 Kg	57 boxes / 900 Kg	-
Ángulo rejilla Dcha./izda. 24,5x33 cm	-	1 pcs. / 4,50 Kg	82 boxes / 369 Kg	-
Media caña 33x4 cm	3 pcs. / ml	52 pcs. / 13 Kg	64 boxes / 832 Kg	-
Arista 33x3 cm	3 pcs. / ml	70 pcs. / 13 Kg	64 boxes / 832 Kg	-
Uña 4x4 cm	-	4 pcs. / 0,4 Kg	72 boxes / 30 Kg	-
Uña arista 3x3 cm	-	4 pcs. / 0,4 Kg	72 boxes / 30 Kg	-

MEDITERRÁNEO	MEDICIONES · MESSUREMENTS · MESURE · ШТУКИ/ m	CAJAS · BOXES · BOITES · КОРБОКИ	PALETS · PALLETS · PALLETES · ПАЛЛЕТЫ	MEDIDAS DE FABRICACIÓN · MANUFACTURING MEASURES
Base 33x33 cm - 10 mm	9 pcs. / m ²	9 pcs. / 22,18 Kg	52 boxes / 1.153 Kg	
Base 33x66,5 cm - 10 mm	4,5 pcs. / m ²	5 pcs. / 25,38 Kg	40 boxes / 1.015 Kg	
Rodapié 9x33 cm	3 pcs. / ml	24 pcs. / 13,92 Kg	72 boxes / 1.002 Kg	
Vierteaguas 12x33x3 cm	3 pcs. / ml	16 pcs. / 18,05 Kg	52 boxes / 938 Kg	
Peldaño Fiorentino 33x33x3 cm - 12 mm	3 pcs. / ml	4 pcs. / 12,49 Kg	56 boxes / 700 Kg	
Cartabón Fiorentino 33x33x3 cm - 14 mm	-	1 pcs. / 4,00 Kg	92 boxes / 368 Kg	
Zanquín Fior. izda./dcha 39,5x17,5 cm	-	14 pcs. / 10,00 Kg	54 boxes / 540 Kg	
Peldaño Recto 33x33x3 cm	3 pcs. / ml	4 pcs. / 12,04 Kg	56 boxes / 674 Kg	
Zanquín Recto izda./dcha 42,3x17,5	-	14 pcs. / 10,00 Kg	54 boxes / 540 Kg	
Pasamanos 12,5x66,5x4 cm	1,5 pcs. / ml	5 pcs. / 18,80 Kg	26 boxes / 489 Kg	
Pasamanos 15,5x66,5x4 cm	1,5 pcs. / ml	5 pcs. / 21,45 Kg	20 boxes / 430 Kg	

EMBALAJE /

PACKING · EMBALLAGE · УПАКОВКА

exagres

TECHNICAL SOLUTIONS

STONE

MILÁN	MEDICIONES · MESSAGES · MEASURE · ШТУКИ/ m	CAJAS · BOXES · BOITES · КОРОБКИ	PALETS · PALLETS · PALLETES · ПАЛЛЕТЫ	MEDIDAS DE FABRICACIÓN · MANUFACTURING MEASURES
Base 75x75 cm - 11 mm	1,78 pcs / m ²	2 pcs. / 29,50 Kg	40 boxes / 1.170 Kg	-
Base 14,5x120 cm - 10,2 mm	5,56 pcs / m ²	4 pcs. / 18,48 Kg	64 boxes / 1.195 Kg	-
Base 33x33 cm - 10 mm	9 pcs. / m ²	9 pcs. / 22,18 Kg	52 boxes / 1.153 Kg	-
Peldaño recto 33x120x3 cm	0,83 pcs / ml	2 pcs. / 25,90 Kg	11 boxes / 285 Kg	-
Remate peldaño recto 3x33 cm	-	20 pcs. / 3,20 Kg	82 boxes / 263 Kg	-
Zanquin recto izda/dcha 42,3x17,5 cm	-	14 pcs. / 10,0 Kg	54 boxes / 540 Kg	-
Rodapié 9x60 cm	1,66 pcs / ml	18 pcs. / 19,80 Kg	42 boxes / 840 Kg	-
Borde piscina skimmer 45x75 cm	1,33 pcs. / ml	2 pcs. / 30,00 Kg	29 boxes / 870 Kg	-

ALBAROC	MEDICIONES · MESSAGES · MEASURE · ШТУКИ/ m	CAJAS · BOXES · BOITES · КОРОБКИ	PALETS · PALLETS · PALLETES · ПАЛЛЕТЫ	MEDIDAS DE FABRICACIÓN · MANUFACTURING MEASURES
Base 100x100 cm - 11 mm	1 pcs / m ²	1 pcs. / 25 Kg	48 boxes / 1.200 Kg	-
Base 14,5x120 cm - 10,2 mm	5,56 pcs / m ²	4 pcs. / 18,48 Kg	64 boxes / 1.195 Kg	-
Base 33x66,5 cm - 10 mm	4,5 pcs. / m ²	5 pcs. / 25,38 Kg	40 boxes / 1.015 Kg	-
Base 33x33 cm - 10 mm	9 pcs. / m ²	9 pcs. / 22,18 Kg	52 boxes / 1.153 Kg	-
Peldaño ML 33x33x4 cm - 13 mm	3 pcs. / ml	4 pcs. / 13,40 Kg	44 boxes / 590 Kg	-
Cartabón ML 33x33x4 cm - 14 mm	-	1 pcs. / 4,00 Kg	92 boxes / 368 Kg	-
Zanquin ML izda/dcha 18x40 cm	-	6 pcs. / 15,00 Kg	57 boxes / 855 Kg	-
Peldaño recto 33x120x3 cm	0,83 pcs / ml	2 pcs. / 25,90 Kg	11 boxes / 285 Kg	-
Remate peldaño recto 3x33 cm	-	20 pcs. / 3,2 Kg	82 boxes / 263 Kg	-
Zanquin recto izda/dcha 18x40 cm	-	6 pcs. / 15,00 Kg	57 boxes / 855 Kg	-
Pasamanos 12,5x66,5x4 cm	1,5 pcs. / ml	5 pcs. / 18,80 Kg	26 boxes / 489 Kg	-
Pasamanos 15,5x66,5x4 cm	1,5 pcs. / ml	5 pcs. / 21,45 Kg	20 boxes / 430 Kg	-
Rodapié 9x40 cm	2,5 pcs. / ml	12 pcs. / 15 Kg	57 boxes / 855 Kg	-

LITOS	MEDICIONES · MESSUREMENTS · MESURE · ШТУКИ/м	CAJAS · BOXES · BOITES · КОРОБКИ	PALETS · PALLETS · PALLETES · ПАЛЛЕТЫ	MEDIDAS DE FABRICACIÓN · MANUFACTURING MEASURES
Base 100x100 cm - 11 mm	1 pcs. / m ²	1 pcs. / 25 Kg	48 boxes / 1.200 Kg	-
Base 60x120 cm - 10,2 mm	1,39 pcs. / m ²	2 pcs. / 36,5 Kg	27 boxes / 987 Kg	-
Base 14,5x120 cm - 10,2 mm	5,56 pcs. / m ²	4 pcs. / 18,48 Kg	64 boxes / 1.195 Kg	-
Base 33x66,5 cm - 10 mm	4,5 pcs. / m ²	5 pcs. / 25,38 Kg	40 boxes / 1.015 Kg	-
Peldaño recto 33x120x3 cm	0,83 pcs. / ml	2 pcs. / 25,90 Kg	11 boxes / 285 Kg	-
Remate peldaño recto 3x33 cm	-	20 pcs. / 3,2 Kg	82 boxes / 263 Kg	-
Zanquín recto izda./dcha 18x40 cm	-	6 pcs. / 15,00 Kg	57 boxes / 855 Kg	-
Rodapié 9x40 cm	2,5 pcs. / ml	12 pcs. / 15 Kg	57 boxes / 855 Kg	-
Borde desbordante 28x66,5 cm	1,5 pcs. / ml	2 pcs. / 13,60 Kg	72 boxes / 980 Kg	-
Ángulo borde desbordante 33x33 cm	-	1 pcs. / 4,30 Kg	92 boxes / 396 Kg	-
Rejilla 24,5x24,5 cm	4 pcs. / ml	6 pcs. / 15,78 Kg	57 boxes / 900 Kg	-
Ángulo rejilla Dcha./Izda. 24,5x33 cm	-	1 pcs. / 4,50 Kg	82 boxes / 369 Kg	-
Media caña 33x4 cm	3 pcs. / ml	52 pcs. / 13 Kg	64 boxes / 832 Kg	-
Arista 33x3 cm	3 pcs. / ml	70 pcs. / 13 Kg	64 boxes / 832 Kg	-
Uña 4x4 cm	-	4 pcs. / 0,4 Kg	72 boxes / 30 Kg	-
Uña arista 3x3 cm	-	4 pcs. / 0,4 Kg	72 boxes / 30 Kg	-

ROCA	MEDICIONES · MESSUREMENTS · MESURE · ШТУКИ/м	CAJAS · BOXES · BOITES · КОРОБКИ	PALETS · PALLETS · PALLETES · ПАЛЛЕТЫ	MEDIDAS DE FABRICACIÓN · MANUFACTURING MEASURES
Base 33x33 cm - 10 mm	9 pcs. / m ²	9 pcs. / 22,18 Kg	52 boxes / 1.153 Kg	-
Base 33x66,5 cm - 10 mm	4,5 pcs. / m ²	5 pcs. / 25,38 Kg	40 boxes / 1.015 Kg	-
Peldaño ML 33x33x4 cm - 13 mm	3 pcs. / ml	4 pcs. / 13,40 Kg	44 boxes / 590 Kg	-
Cartabón ML 33x33x4 cm - 14 mm	-	1 pcs. / 4,00 Kg	92 boxes / 368 Kg	-
Zanquín ML izda./dcha 39,5x17,5 cm	-	14 pcs. / 10,00 Kg	54 boxes / 540 Kg	-
Peldaño Recto 33x33x3 cm - 12 mm	3 pcs. / ml	4 pcs. / 12,04 Kg	56 boxes / 675 Kg	-
Zanquín Recto izda./dcha 42,3x17,5	-	14 pcs. / 10,00 Kg	54 boxes / 540 Kg	-
Rodapié 9x33 cm	3 pcs. / ml	24 pcs. / 13,92 Kg	72 boxes / 1.002 Kg	-
Borde desbordante 28x66,5 cm	1,5 pcs. / ml	2 pcs. / 13,60 Kg	72 boxes / 980 Kg	-
Ángulo borde desbordante 33x33 cm	-	1 pcs. / 4,30 Kg	92 boxes / 396 Kg	-
Rejilla 24,5x24,5 cm	4 pcs. / ml	6 pcs. / 15,78 Kg	57 boxes / 900 Kg	-
Ángulo rejilla Dcha./Izda. 24,5x33 cm	-	1 pcs. / 4,50 Kg	82 boxes / 369 Kg	-
Media caña 33x4 cm	3 pcs. / ml	52 pcs. / 13 Kg	64 boxes / 832 Kg	-
Arista 33x3 cm	3 pcs. / ml	70 pcs. / 13 Kg	64 boxes / 832 Kg	-
Uña 4x4 cm	-	4 pcs. / 0,4 Kg	72 boxes / 30 Kg	-
Uña arista 3x3 cm	-	4 pcs. / 0,4 Kg	72 boxes / 30 Kg	-

EMBALAJE /

PACKING · EMBALLAGE · УПАКОВКА

exagres

TECHNICAL SOLUTIONS

MANHATTAN	MEDICIONES · MESSUREMENTS · MESURE · ШТУКИ/ m	CAJAS · BOXES · BOITES · КОРОБКИ	PALETS · PALLETS · PALLETES · ПАЛЛЕТЫ	MEDIDAS DE FABRICACIÓN · MANUFACTURING MEASURES
Base 24,5x24,5 cm - 9 mm	16 pcs. / m ²	16 pcs. / 19,79 Kg	69 boxes / 1.365 Kg	-
Base 12x24,5 cm - 9 mm	32 pcs. / m ²	35 pcs. / 19,25 Kg	77 boxes / 1.482 Kg	-
Listelo 5,75x24,5 cm (doble)	64 pcs. / m ²	72 pcs. / 20,16 Kg	77 boxes / 1.552 Kg	-
Rodapié 9x24,5 cm	4 pcs. / ml	32 pcs. / 12,01 Kg	80 boxes / 960 Kg	-
Vierteaguas 15x24,5x4 cm	4 pcs. / ml	8 pcs. / 7,00 Kg	78 boxes / 546 Kg	-
Peldaño ML 24,5x33x4 cm - 13 mm	4 pcs. / ml	4 pcs. / 9,50 Kg	66 boxes / 627 Kg	-
Cartabón ML 33x33x4 cm - 14 mm	-	1 pcs. / 4,00 Kg	92 boxes / 368 Kg	-
Zanquín ML izda/dcha 39,5x17,5 cm	-	14 pcs. / 10,00 Kg	54 boxes / 540 Kg	-

PETRA	MEDICIONES · MESSUREMENTS · MESURE · ШТУКИ/ m	CAJAS · BOXES · BOITES · КОРОБКИ	PALETS · PALLETS · PALLETES · ПАЛЛЕТЫ	MEDIDAS DE FABRICACIÓN · MANUFACTURING MEASURES
Base 33x33 cm - 10 mm	9 pcs. / m ²	9 pcs. / 22,18 Kg	52 boxes / 1.153 Kg	-
Rodapié 9x33 cm	3 pcs. / ml	24 pcs. / 13,92 Kg	72 boxes / 1.002 Kg	-
Peldaño Fiorentino 33x33x3 cm - 12 mm	3 pcs. / ml	4 pcs. / 12,49 Kg	56 boxes / 700 Kg	-
Cartabón Fiorentino 33x33x3 cm - 14 mm	-	1 pcs. / 4,00 Kg	92 boxes / 368 Kg	-
Zanquín Fior. izda/dcha 39,5x17,5 cm	-	14 pcs. / 10,00 Kg	54 boxes / 540 Kg	-
Taco Petra Etna 8x8 cm	-	108 pcs. / 17,28 Kg	-	-
Tabica Etna Petra 15x33 cm	3 pcs. / ml	12 pcs. / 13,20 Kg	90 boxes / 1.188 Kg	-
Borde piscina 28x33 cm	3 pcs. / ml	4 pcs. / 21,52 Kg	38 boxes / 817 Kg	-
Ángulo Interior 33x33 cm	-	1 pcs. / 4,80 Kg	92 boxes / 441 Kg	-
Ángulo exterior 28x28 cm	-	1 pcs. / 4,00 Kg	92 boxes / 368 Kg	-

VEGA	MEDICIONES · MESSUREMENTS · MESURE · ШТУКИ/ m	CAJAS · BOXES · BOITES · КОРОБКИ	PALETS · PALLETS · PALLETES · ПАЛЛЕТЫ	MEDIDAS DE FABRICACIÓN · MANUFACTURING MEASURES
Base 33x33 cm - 10 mm	9 pcs. / m ²	9 pcs. / 22,18 Kg	52 boxes / 1.153 Kg	-
Rodapié 9x33 cm	3 pcs. / ml	24 pcs. / 13,92 Kg	72 boxes / 1.002 Kg	-
Peldaño Fiorentino 33x33x3 cm - 12 mm	3 pcs. / ml	4 pcs. / 12,49 Kg	56 boxes / 700 Kg	-
Cartabón Fiorentino 33x33x3 cm - 14 mm	-	1 pcs. / 4,00 Kg	92 boxes / 368 Kg	-
Zanquín Fior. izda/dcha 39,5x17,5 cm	-	14 pcs. / 10,00 Kg	54 boxes / 540 Kg	-
Vierteaguas 12x33x3 cm	3 pcs. / ml	16 pcs. / 18,05 Kg	52 boxes / 938Kg	-

EARTH

LUCCA	MEDICIONES · MEASUREMENTS · MESURE · ШТУКИ/ m	CAJAS · BOXES · BOITES · КОРОБКИ	PALETS · PALLETS · PALLETES · ПАЛЛЕТЫ	MEDIDAS DE FABRICACIÓN · MANUFACTURING MEASURES
Base 33x33 cm - 10 mm	9 pcs. / m ²	9 pcs. / 22,18 Kg	52 boxes / 1.153 Kg	-
Base 16,25x33 cm - 10 mm	18 pcs. / m ²	18 pcs. / 21,60 Kg	56 boxes / 1.210 Kg	-
Base 16,25x16,25 cm - 10 mm	36 pcs. / m ²	18 pcs. / 10,80 Kg	112 boxes / 1.210 Kg	-
Rodapié 9x33 cm	3 pcs. / ml	24 pcs. / 13,92 Kg	72 boxes / 1.002 Kg	-
Peldaño ML 33x33x4 cm - 13 mm	4 pcs. / ml	4 pcs. / 13,40 Kg	44 boxes / 590 Kg	-
Cartabón ML 33x33x4 cm - 14 mm	-	1 pcs. / 4,00 Kg	92 boxes / 368 Kg	-
Zanquín ML izda/dcha 39,5x17,5 cm	-	14 pcs. / 10,00 Kg	54 boxes / 540 Kg	-
Vierteaguas 15x33x4 cm	3 pcs. / ml	8 pcs. / 10,56 Kg	52 boxes / 550 Kg	-
Borde piscina 28x33 cm	3 pcs. / ml	4 pcs. / 21,52 Kg	38 boxes / 817 Kg	-
Ángulo Interior 33x33 cm	-	1 pcs. / 4,80 Kg	92 boxes / 441 Kg	-
Ángulo exterior 28x28 cm	-	1 pcs. / 4,00 Kg	92 boxes / 368 Kg	-

ALHAMAR	MEDICIONES · MEASUREMENTS · MESURE · ШТУКИ/ m	CAJAS · BOXES · BOITES · КОРОБКИ	PALETS · PALLETS · PALLETES · ПАЛЛЕТЫ	MEDIDAS DE FABRICACIÓN · MANUFACTURING MEASURES
Base 33x33 cm - 10 mm	9 pcs. / m ²	9 pcs. / 22,18 Kg	52 boxes / 1.153Kg	-
Base 16,25x33 cm - 10 mm	18 pcs. / m ²	18 pcs. / 21,60 Kg	56 boxes / 1.210 Kg	-
Base 16,25x16,25 cm - 10 mm	36 pcs. / m ²	18 pcs. / 10,80 Kg	112 boxes / 1.210 Kg	-
Rodapié 9x33 cm	3 pcs. / ml	24 pcs. / 13,92 Kg	72 boxes / 1.002 Kg	-
Peldaño Fiorentino 33x33x3 cm - 12 mm	3 pcs. / ml	4 pcs. / 12,49 Kg	56 boxes / 700 Kg	-
Cartabón Fiorentino 33x33x3 cm - 14 mm	-	1 pcs. / 4,00 Kg	92 boxes / 368 Kg	-
Zanquín Fior. izda/dcha 39,5x17,5 cm	-	14 pcs. / 10,00 Kg	54 boxes / 540 Kg	-
Vierteaguas 15x33x4 cm	3 pcs. / ml	8 pcs. / 10,56 Kg	52 boxes / 550 Kg	-
Decorative / Clay 33x33 cm	9 pcs. / m ²	9 pcs. / 22,18 Kg	52 boxes / 1.153 Kg	-
Tabica Clay 15x33 cm	3 pcs. / ml	12 pcs. / 13,20 Kg	82 boxes / 1.083 Kg	-

EMBALAJE /

PACKING · EMBALLAGE · УПАКОВКА



METAL

METÁLICA	MEDICIONES · MEASUREMENTS · MESURE · ШТУКИ/ m	CAJAS · BOXES · BOITES · КОРБКИ	PALETS · PALLETS · PALLETES · ПАЛЛЕТЫ	MEDIDAS DE FABRICACIÓN· MANUFACTURING MEASURES
Base 33x33 cm - 10 mm	9 pcs. / m ²	9 pcs. / 22,18 Kg	52 boxes / 1.153 Kg	-
Rodapié 9x33 cm	3 pcs. / ml	24 pcs. / 13,92 Kg	72 boxes / 1.002 Kg	-
Peldaño Fiorentino 33x33x3 cm - 12 mm	3 pcs. / ml	4 pcs. / 12,49 Kg	56 boxes / 700 Kg	-
Cartabón Fiorentino 33x33x3 cm - 14 mm	-	1 pcs. / 4,00 Kg	92 boxes / 368 Kg	-
Zanquin Fio. izda./dcha 39,5x17,5 cm	-	14 pcs. / 10,00 Kg	54 boxes / 540 Kg	-



EXAGRES se reserva el derecho de anular, modificar total o parcialmente cualquiera de los colores, formatos, referencias y especificaciones técnicas contenidas en este catálogo. Los colores reproducidos en este catálogo son orientativos y pueden variar respecto a la pieza original. Los códigos de precios, medidas y referencias deben verificarse ya que pueden haber errores tipográficos.

EXAGRES reserves the right to partially or totally cancel or modify any of the colours, formats, references and technical specifications contained in this catalogue. The colours reproduced in this catalogue are intended as a guide and may vary in the original piece. The price codes, measures and references must be verified as there may be typographical errors.

EXAGRES se réserve le droit d'annuler, de modifier totalement ou partiellement toutes les couleurs, tous les formats, toutes les références et spécificités techniques contenues dans ce catalogue. Les couleurs reproduites dans ce catalogue sont à titre indicatif et peuvent varier par rapport à la pièce originale. Les codes de prix, les mesures et les références doivent être vérifiés, car il peut y avoir des erreurs typographiques.

Компания EXAGRES оставляет за собой право отменить или изменить, полностью или частично, любой из цветов, форматов, артикулов, а также технические характеристики, содержащиеся в этом каталоге. Все приведенные в данном каталоге цвета являются приблизительными и могут незначительно отличаться от цвета оригинального изделия. Цены, размеры и номера артикулов должны быть предварительно уточнены, поскольку в каталоге могут присутствовать типографические опечатки.



Atla, línea de luz Apdo. 707
1544610
[Castellón] Spain
tel. (+34) 964 63 253
info@exagres.es
www.exagres.es