

COLLECTIONS

2020



GARDENIA
ORCHIDEA

COLLECTIONS



INDEX

about us

- 4 Company
- 5 New Technologies
- 6 Made in Italy
- 7 Environment

pavimenti

FLOOR TILES_SOLS_BODEN_
PAVIMENTOS_ПОЛЫ_地砖



le Pietre

8

- 10 Amboise
- 24 Burlington Stone
- 34 Concept Stone
- 50 Esedra 2.0
- 62 Origini
- 78 Unique



i Cementi

94

- 96 D.sign
- 106 Make
- 120 Mood
- 134 Native
- 144 Walk



i Legni

156

- 158 Just Life
- 170 Just Code
- 184 Just Color
- 198 Just Mix
- 212 Just Nature
- 226 Just Venice

pavimenti per esterni

OUTDOOR FLOORS_BÖDEN IM FREIEN_SOLS EXTÉRIEURS
PAVIMENTOS PARA EXTERIOR_ОТКРЫТЫЙ ПОЛ_户外地板

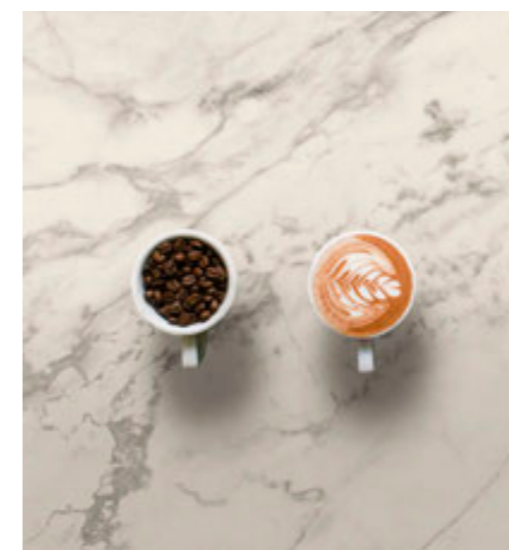

Slabs

240

- 242 Slabs

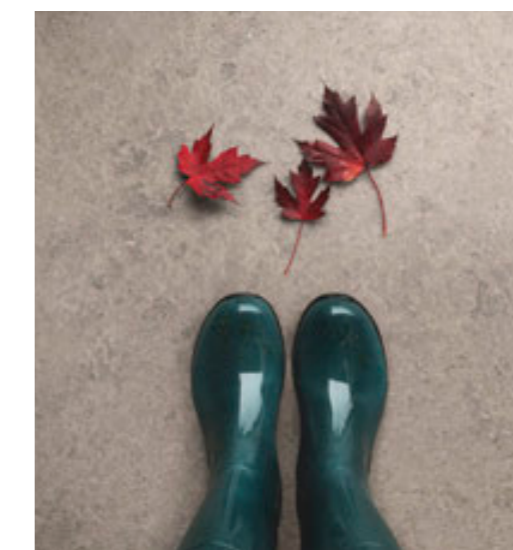

Outdoor 20MM - 9MM



288

- 290 Outdoor 20MM - 9MM

informazioni tecniche

INFORMAZIONI TECNICHE_INFORMATIONS TECHNIQUES
TECHNISCHE INFORMATIONEN_INFORMACIONES TÉCNICAS
ТЕХНИЧЕСКАЯ ИНФОРМАЦИЯ_我怕我怕生活是个噩

- 324 Certificazioni
- 326 Le principali informazioni
- 330 Le principali caratteristiche estetiche
- 331 Elementi decorativi
- 334 Avvertenze per l'installazione
- 336 Avvertenze per l'installazione di prodotti rettificati
- 337 Le grandi lastre
- 340 Pulizia e manutenzione
- 343 Caratteristiche generali
- 346 Garanzia e reclami

Company

Gardenia nasce nel 1961 da una visione nuova dell'ambiente domestico, una visione basata sull'innovazione estetica e sulla continua evoluzione dei metodi produttivi. Diventa in pochi anni un gruppo ceramico di livello mondiale, la cui produzione ogni anno supera i 4 milioni di metri quadrati. Le ceramiche sono pensate nel dettaglio: sempre in sintonia con l'evoluzione dello stile e sempre realizzate in loco, per mantenere l'esclusività e la completa autonomia espressiva per le quali Gardenia è famosa nel mondo.

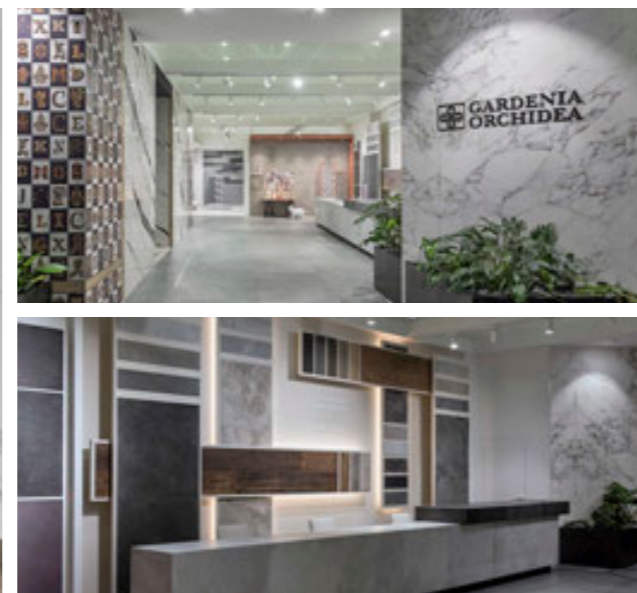
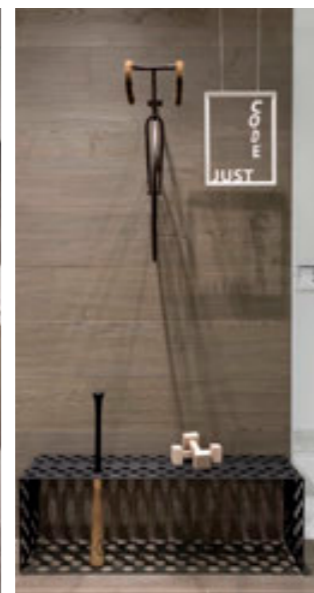

company

Gardenia was founded in 1961, based on a new vision of the home environment, a vision based on innovation in design and the constant evolution of production methods. In just a few years, it became a globally renowned ceramic group, with an annual production of over 4 million square metres. Ceramics are designed down to the finest detail: in constant harmony with evolving styles and always created locally, to maintain the exclusivity and total expressive autonomy that Gardenia is famous for worldwide.

Firma

Gardenia entstand 1961 aus einer neuen Sichtweise der häuslichen Umgebung, einer Sichtweise, die auf der ästhetischen Innovation und der ständigen Weiterentwicklung der Produktionsmethoden beruht. In wenigen Jahren wurde sie zu einer Keramikgruppe auf weltweitem Niveau, deren Produktion jährlich mehr als 4 Millionen Quadratmeter beträgt. Die Keramikprodukte sind bis ins kleinste Detail durchdacht: Immer im Einklang mit der Evolution des Stils und immer vor Ort gefertigt, um die Exklusivität und die komplette Ausdrucksautonomie beizubehalten, für die Gardenia in der ganzen Welt berühmt ist.

enterprise

Gardenia naît en 1961 à partir d'une nouvelle vision de l'environnement domestique, une vision qui repose sur l'innovation esthétique et sur l'évolution continue des méthodes de production. L'entreprise devient, en quelques années seulement, un groupe céramique d'envergure mondiale et sa production dépasse chaque année 4 millions de mètres carrés. Les céramiques sont conçues dans le détail : toujours en harmonie avec l'évolution du style et toujours réalisées in loco afin de conserver l'exclusivité ainsi que toute l'autonomie d'expression grâce auxquelles Gardenia est célèbre dans le monde entier.

empresa

Gardenia nace en 1961 y es fruto de una visión nueva del entorno doméstico, una visión basada sobre la innovación estética y sobre la evolución continua de los métodos productivos. En pocos años se convierte en un grupo cerámico de alcance mundial, cuya producción anual supera los 4 millones de metros cuadrados. Los cerámicos se crean cuidando cada detalle: siempre en sintonía con la evolución del estilo y fabricados localmente, para mantener la exclusividad y la autonomía expresiva completa que dieron su fama mundial a Gardenia.

О КОМПАНИИ

Компания Gardenia была создана в 1961 году благодаря новому подходу к концепции домашнего интерьера, основанному на эстетической инновации и постоянном развитии методов производства. Всего лишь за несколько лет компания становится производителем керамической плитки международного уровня; каждый год она выпускает более 4 миллионов квадратных метров продукции. Продумываются детали каждой модели плитки: она всегда соответствует новому стилю и ее производство осуществляется всегда на месте, что позволяет ей оставаться эксклюзивным продуктом, обладающим самостоятельными экспрессивными средствами, сделавшими знаменитой компанию Gardenia во всем мире.

公司简介

Gardenia公司成立于1961年，在美学设计日益创新和生产方式不断改进的基础上，致力开拓家居环境的全新视野。公司在短短数年内迅速发展成为一家大型国际陶瓷集团，陶瓷产品年产量超过4亿平方米。本集团的陶瓷产品对细节高度重视：总是与风格的演变搭配和谐，总是在现场制作，以保持产品的独特性和完全的自由表达，Gardenia集团正是因此而驰名世界。

Made in Italy

about us

Il fulcro della visione di Gardenia è sempre stata la casa, intesa come spazio abitativo ma anche come ambiente, come territorio. Per questo la produzione del gruppo Gardenia è concentrata in Italia, dalla progettazione a ogni fase del processo produttivo. La storia dell'azienda è la storia di un paese, di un linguaggio. Da qui proviene l'innovazione e l'esclusività dei suoi prodotti. È qui che Gardenia ha la sua casa, ed è qui che nel 1997 inizia l'importante sodalizio con Versace, un marchio con il quale Gardenia ha grandi affinità: per l'importanza attribuita al design, per la sensibilità unica nella decorazione di interni, per la voglia di cambiare, sempre ai massimi livelli.

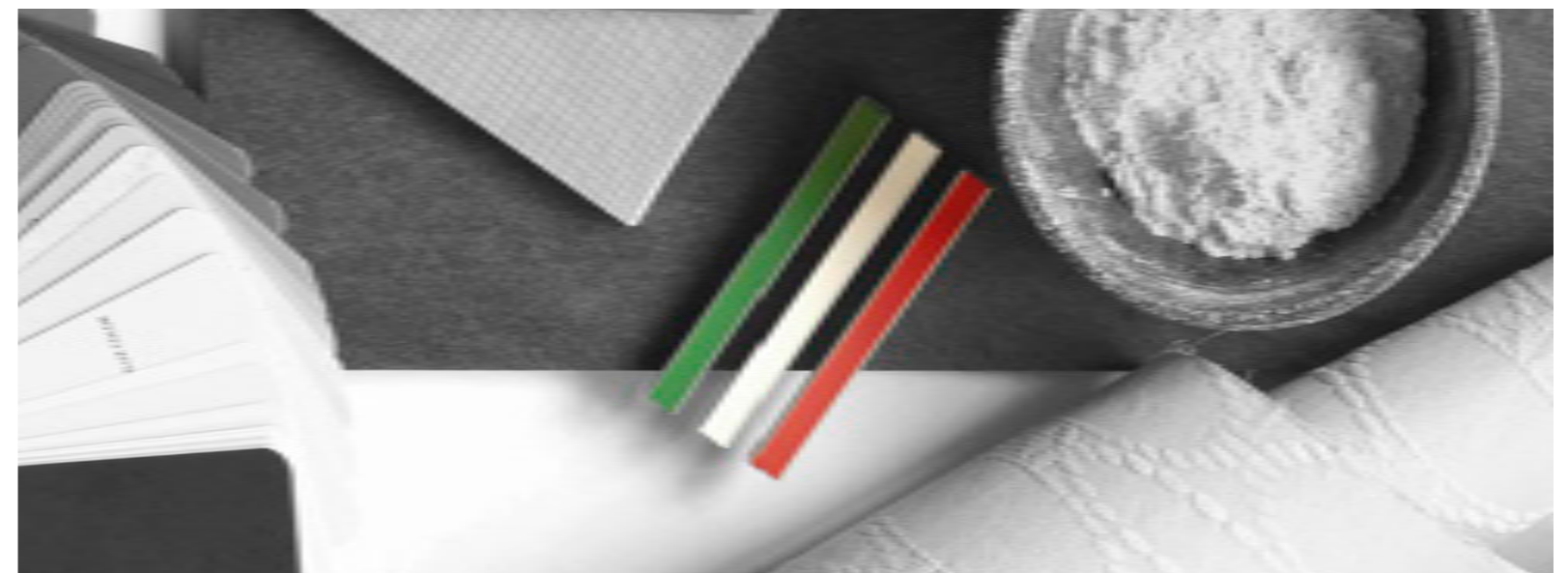

made in italy

The focal point of Gardenia's vision has always been the home, a living space yet also an environment, a territory. This is why the Gardenia group's production, from design to all phases of the production process, is concentrated in Italy. The company's history is the history of a country, a language. This is where the innovation and exclusivity of its products come from. And it is here that Gardenia has its home, it is here that in 1997 it began an important partnership with Versace, a brand that Gardenia shares many values with: the importance of design, the unique sensitivity in interior design, the design for change, always at the highest quality levels.

made in italy

Le cœur de la vision de Gardenia a toujours été la maison, considérée non seulement comme espace d'habitation mais aussi comme environnement et territoire. Pour cette raison, la production du groupe Gardenia est concentrée en Italie, depuis la conception jusqu'à chacune des phases du processus de production. L'histoire de l'entreprise est l'histoire d'un pays, d'un langage. De là proviennent l'innovation et l'exclusivité de ses produits. C'est en Italie que l'entreprise Gardenia a son siège et qu'elle débute son importante alliance avec Versace, une marque avec laquelle elle a de grandes affinités pour l'importance attribuée au design, pour la sensibilité unique dans la décoration d'intérieurs et pour l'envie de changer, toujours à des niveaux très élevés.

hecho en italia

El fulcro de la visión de Gardenia siempre ha sido el hogar, entendido como espacio habitacional y también como entorno y territorio. Por eso la producción del grupo Gardenia se ha concentrado en Italia, desde el diseño a cada fase del proceso productivo. La historia de la empresa es la historia de un país, de una lengua. De aquí procede la innovación y exclusividad de sus productos. Es aquí donde Gardenia tiene su casa y es aquí donde en 1997 comienza su importante colaboración con Versace, una marca con la que Gardenia posee una gran afinidad: por la importancia atribuida al diseño, por la sensibilidad única en la decoración de interiores, por las ganas de cambiar, siempre al nivel más alto.

made in italy

Der Kern der Vision von Gardenia war immer das Haus im Sinne eines Wohnraums, aber auch als Umgebung oder als Bereich. Deshalb ist die Produktion der Gruppe Gardenia in Italien konzentriert, von der Planung bis hin zu allen Phasen des Produktionsprozesses. Die Geschichte der Firma ist die Geschichte eines Landes, einer Sprache. Von hierher stammen die Innovation und Exklusivität ihrer Produkte. Hier ist Gardenia zuhause, und hier begann 1997 die bedeutende Partnerschaft mit Versace, einer Marke, mit der Gardenia Vieles verbindet: Aufgrund der Bedeutung, die dem Design beigemessen wird, der einzigartigen Sensibilität bei der Dekoration der Innenräume und der Lust auf Veränderung, immer auf höchstem Niveau.

made in italy

В центре концепции компании Gardenia был всегда дом, как жилое пространство, но в то же время воспринимаемый как среда, как территория. Именно поэтому все производство группы Gardenia сконцентрировано в Италии, от этапа проектирования до производственного процесса. История компании – это и история страны, национального языка. Она служит источником для инноваций и эксклюзивности ее продукции. Дом компании Gardenia находится именно в Италии, и именно здесь в 1997 году началось важное сотрудничество с Versace – брендом, с которым у группы Gardenia много общего: это особое внимание, уделяемое дизайну, уникальный тонкий вкус в отделке интерьера, стремление к постоянному обновлению, постоянный высочайший уровень.

意大利制造

Gardenia集团的视野核心一直是家居，它可以理解为生活空间，但也可以理解为环境、领域。因此，Gardenia集团的生产集中在意大利，从设计到生产过程的每一个阶段，全部在意大利完成。企业的历史是一个国家的历史，一门语言的历史。产品的创新和独特性正是由此而来。Gardenia集团的家正是由此建成，而集团正是由此于1997年开始与范思哲品牌的强强合作。Gardenia集团与该品牌具有众多共同点：对设计的高度重视，对室内装饰的独特感受，对改变的强烈渴望，总是在最高程度。

New technologies

La costante ricerca di Gardenia su materiali, finiture, decorazioni e tendenze ha portato l'azienda ad un costante rinnovamento.

Negli ultimi anni Gardenia ha subito una profonda ristrutturazione introducendo sistemi innovativi per la produzione di grandi formati e sistemi di stampa digitale ad alta risoluzione, sperimentati per la prima volta in Italia.

Ricerca e sviluppo 2020

DDG, decoratrice digitale a secco, è la denominazione della nuova tecnologia per deposizione di materie ceramiche sulla superficie di ogni materiale. Questo rivoluzionario processo produttivo consente di applicare differenti materie sincronizzandole e integrandole perfettamente con la grafica sottostante realizzata con tecnologia digitale ad alta definizione. Attraverso la combinazione di queste due tecnologie applicative, si ottengono soluzioni sino ad ora inedite combinando matericità ed estetica con ampia variabilità, conferendo ad ogni elemento un autentico valore sensoriale.



DECORAZIONE DIGITALE A SECCO
DIGITAL DRY DECORATION

new technologies

The constant research focused on materials, finishes, decorations and trends has driven the continual progress of Gardenia. Over recent years, Gardenia has undergone a profound refurbishment introducing innovative large-sized tile manufacturing processes and high-resolution digital printing systems, all of which are implemented for the first time in Italy.

Research and Development in 2020

Digital Dry Decorator (DDG) is the name of the new technology for depositing ceramic materials on the surface of all materials. This revolutionary production process is used to apply a variety of materials, synchronising and integrating them perfectly with the underlying graphics made using high-definition digital technology. New solutions are obtained by combining these two application technologies to achieve unique results in terms of textures and appearance, adding real sensory value to each element.

nouvelles technologies

La recherche continue de Gardenia sur les matériaux, sur les finitions, sur les décorations et sur les tendances a conduit l'entreprise à vivre dans un renouvellement continu. Ces dernières années, Gardenia a entrepris une importante restructuration, à commencer par la production de grands formats et de systèmes d'impression numérique haute résolution, expérimentés par la première fois en Italie.

Recherche et développement 2020

DDG, machine d'impression numérique à sec : tel est le nom de la nouvelle technologie par dépôt de céramique sur la surface de n'importe quel matériau. Ce processus de production révolutionnaire permet d'appliquer différentes matières en les synchronisant et en les intégrant parfaitement au graphisme en dessous, réalisé avec des technologies numériques haute résolution. Une combinaison de ces deux technologies d'application permet d'obtenir des solutions inédites, en associant l'aspect matériel et esthétique à la variabilité, donnant ainsi à chaque élément une authentique valeur sensorielle.

neue Technologien

Dank der ständigen Forschung von Gardenia bezüglich der Materialien, Oberflächenausführungen und Trends erlebt die Firma eine ständige Erneuerung. In den letzten Jahren hat Gardenia eine wichtige Restrukturierung in Gang geleitet, indem sie innovative Systeme für die Produktion der großen Formate und den hochauflösenden Digitaldruck - den sie in Italien als Erste verwendet hat - eingeführt hat.

Forschung und Entwicklung 2020

Mit der digitalen Trockendekormaschine (**DDG**) wird eine neue Technologie zur Ablagerung von keramischen Materialien auf der Oberfläche jedes Materials erschlossen. Dieser revolutionäre Produktionsprozess ermöglicht es, verschiedene Materialien zu verwenden, die perfekt mit den zugrundeliegenden Grafiken, die mit hochauflösender digitaler Technologie hergestellt wurden, synchronisiert und integriert werden. Durch die Kombination dieser beiden Anwendungstechnologien werden bisher unverfügbare Lösungen durch die Kombination von Stofflichkeit und Ästhetik mit großer Variabilität erzielt, die jedem Element einen echten sensorischen Wert verleihen.

nuevas tecnologías

La continua investigación de Gardenia en materiales, acabados, decoraciones y tendencias supone para la empresa una renovación constante. En los últimos años, Gardenia ha experimentado una profunda reestructuración introduciendo sistemas innovadores para la producción de grandes formatos y sistemas de impresión digital de alta resolución, experimentados por primera vez en Italia.

Investigación y desarrollo 2020

DDG, máquina digital en seco para decorar, es el nombre de la nueva tecnología que deposita materia cerámica sobre la superficie de cada material. Este revolucionario proceso de producción permite aplicar diferentes materiales, sincronizándolos e integrándolos perfectamente con el elemento gráfico subyacente creado con tecnología digital de alta resolución. Mediante la combinación de estas dos tecnologías de aplicación, se obtienen soluciones hasta ahora inéditas al combinar textura y estética con una amplia variabilidad, aportando a cada elemento un auténtico valor sensorial.

новые технологии

Благодаря постоянным исследованиям новых материалов, отделок, декоров и тенденций компания Gardenia находится в непрерывном процессе обновления. В последние годы компания Gardenia провела существенную реструктуризацию предприятия и ввела новые инновационные системы по производству плитки большого формата и системы цифровой печати с высокой степенью разрешения, которую компания первой внедрила в Италии.

Исследования и разработки 2020

Система цифровой печати **DDG** — это новая технология для нанесения керамических веществ на поверхность любого материала. Этот инновационный процесс производства позволяет наносить разные вещества, синхронизируя их и безупречно интегрируя с базовой графикой, созданной с использованием цифровой технологии с высокой степенью разрешения. Комбинация этих двух технологий приводит к уникальным результатам, объединяющим характеристики материала с эстетикой и придающим аутентичную ценность каждому отдельному элементу.

新技术

Gardenia公司对材料、饰面、装饰和趋势的不断研究，使公司不断创新。近年来，Gardenia公司进行了深刻的重组，引入了用于生产大规格产品的创新系统和高清数字印刷系统，这在意大利属于首次尝试。

2020年研发

干式数码装饰机DDG，是在任何材料表面上沉积陶瓷材料的新技术的名称。这一革命性的生产过程，使您可以应用不同的材料，通过高清数字技术实现的基础图形，将它们完美地同步和集成在一起。通过这两种应用技术的结合，将质感和美观与多样的变化相结合，可以获得前所未有的崭新解决方案，从而为每个元素提供真实的感官价值。

Environment

La cura di Gardenia per gli spazi vitali non si ferma alle quattro mura della casa. Grazie a processi industriali più puliti e rispettosi dell'ambiente, prodotti realizzati con materiali riciclati, utilizzo sostenibile delle materie prime e eliminazione sicura delle sostanze pericolose il gruppo è all'avanguardia della produzione ecologica.

Dal 2009, attraverso gli strumenti LIFE+ e CIP Eco-Innovation, ha ottenuto l'appoggio della Commissione Europea per la ricerca e lo sviluppo di diversi progetti eco-innovativi: Natstocer, Energeo, Wap-Wir ed Eco Bull-Nose 2.0.

www.gardenia.it/eco-gardenia/



environment

The attention Gardenia pays to living spaces is not limited to the four walls of a home. Thanks to the cleaner and more environmentally respectful industrial processes, products made from recycled materials, the sustainable use of raw materials and the safe elimination of hazardous substances, the group lies at the cutting edge of ecological production.

Since 2009, through the LIFE+ and CIP Eco-Innovation tools, it has earned the support of the European Commission for the research and development of various eco-innovative projects: Natstocer, Energeo, Wap-Wir and Eco Bull-Nose 2.0.

environnement

Le soin que prête Gardenia aux espaces vitaux ne se limite pas aux quatre murs de la maison. Grâce à des processus industriels plus propres et plus respectueux de l'environnement, à des produits réalisés à partir de matériaux recyclés, à une utilisation durable des matières premières et à une élimination sûre des substances dangereuses, le groupe Gardenia est à l'avant-garde de la production écologique. Depuis 2009, à travers les instruments LIFE+ et CIP Eco-Innovation, elle a obtenu l'appui de la commission européenne pour la recherche et le développement de différents projets éco-novateurs: Natstocer, Energeo, Wap-Wir et Eco Bull-Nose 2.0.

medio ambiente

El cuidado que Gardenia pone en los espacios vitales no se queda dentro de las cuatro paredes de casa. Gracias a procesos industriales más limpios y respetuosos del medio ambiente, a productos hechos con materiales reciclados, al uso sostenible de las materias primas y a la eliminación segura de las sustancias peligrosas, el grupo se sitúa en la vanguardia de la producción ecológica.

Desde 2009, mediante las herramientas LIFE+ y CIP Eco-Innovation, ha obtenido el apoyo de la Comisión Europea para la investigación y desarrollo de distintos proyectos eco-innovadores: Natstocer, Energeo, Wap-Wir and Eco Bull-Nose 2.0.

Umwelt

Die Rücksicht von Gardenia auf die Lebensräume beschränkt sich nicht nur auf die eigenen vier Wände. Dank saubereren, umweltfreundlichen Industrieprozessen, mit wiederverwerteten Materialien erzeugten Produkten, einem nachhaltigen Einsatz der Rohstoffe und einer sicheren Beseitigung der gefährlichen Stoffe gehört die Gruppe zur Avantgarde der ökologischen Produktion. Seit 2009 hat sie anhand der Programme LIFE+ und CIP Eco-Innovation die Unterstützung der Europäischen Kommission für die Forschung und Entwicklung von verschiedenen ökologischen Projekten erhalten: Natstocer, Energeo, Wap-Wir und Eco Bull-Nose 2.0.

окружающая среда

Внимание компании Gardenia к жилому пространству не ограничивается четырьмя стенами дома. Благодаря все более экологически чистым производственным процессам и ответственному отношению к окружающей среде, использованию вторичного сырья, рациональному использованию первичного сырья и безопасному удалению вредных веществ, группа находится в авангарде процесса внедрения экологически чистого производства.

С 2009 года благодаря использованию таких инструментов, как LIFE+ и CIP Eco-Innovation, компания получила поддержку Европейской Комиссии по развитию экологически инновационных исследований и различных проектов: Natstocer, Energeo, Wap-Wir ed Eco Bull-Nose 2.0.

环境保护

Gardenia集团对生活空间的保护不限于家居的四面墙壁之内。由于工业生产过程更清洁、更环保，产品采用回收材料制造，对原材料的可持续使用以及对有害物质物质的安全处理，本集团是生态生产的先锋企业。自2009年以来，通过工具LIFE+和CIP生态创新，获得了欧盟委员会的支持，从事各种生态创新项目的研究和开发：Natstocer、Energeo、Wap-Wir 和 Eco Bull-Nose 2.0。

about us



le Pietre

pragetti

- 10 Amboise
- 24 Burlington Stone
- 34 Concept Stone
- 50 Esedra 2.0
- 62 Origini
- 78 Unique

le Pietre

Amboise

GRES FINE PORCELLANATO AD IMPASTO COLORATO

COLORBODY FINE PORCELAIN STONEWARE

GRES CÉRAMÉ TEINTÉ DANS LA MASSE

FEINSGEINZEUG MIT EINGEFÄRBTEN SCHERBEN

GRES PORCELÁNICO MASA COLOREADA

ОКРАШЕННЫЙ ПО ВСЕ ТОЛЩИНЕ КЕРАМОГРАНИТ

彩色坯体瓷质玻化上釉砖



TECNOLOGIA AD ALTA DEFINIZIONE
HIGH-DEFINITION TECHNOLOGY



DECORAZIONE DIGITALE A SECCO
DIGITAL DRY DECORATION

MOSAICI E DECORI



2 SUPERFICI (NATURALI)

NATURAL SURFACES

SURFACES NATURELLES

NATÜRLICHE OBERFLÄCHEN

SUPERFICIES NATURALES

НАТУРАЛЬНАЯ ПОВЕРХНОСТЬ

天然表面



R9-R12

R10 GRUPPO A (INDOOR)

DCOF > 0,42

ASTM C1028 > 0,60

BCRA W.D. > 0,40

PTV FOUR 6 W.D. > 0,36

R11 GRUPPO C (OUTDOOR)

DCOF > 0,42

ASTM C1028 > 0,60

BCRA W.D. > 0,40

PTV FOUR 6 W.D. > 0,36

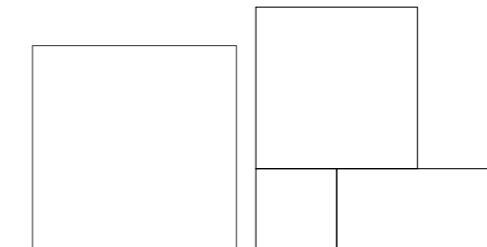

100x100

40"x40"

100x100

40"x40"

80x80

32"x32"

80x80

32"x32"

40x80

16"x32"

40x80

16"x32"

40x40

16"x16"

40x40

16"x16"



80x80

32"x32"

80x80

32"x32"

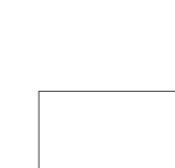

40x80

16"x32"



60x120

24"x48"



20x120

8"x48"

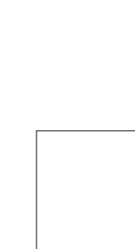

60x60

24"x24"



CALCE

V4



CEMENTO

V4



POLVERE

V4

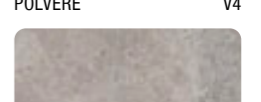

FANGO

V4



FLOOR: CALCE 80X80-40X80-40X40
OUTDOOR CALCE 80X80 R12
WALL: CALCE MATTONCINO BURATTATO 10X30



FLOOR: CEMENTO 80X80
WALL: DECORO AFFRESCO POLVERE 60X120





CALCE



CEMENTO



POLVERE



FANGO

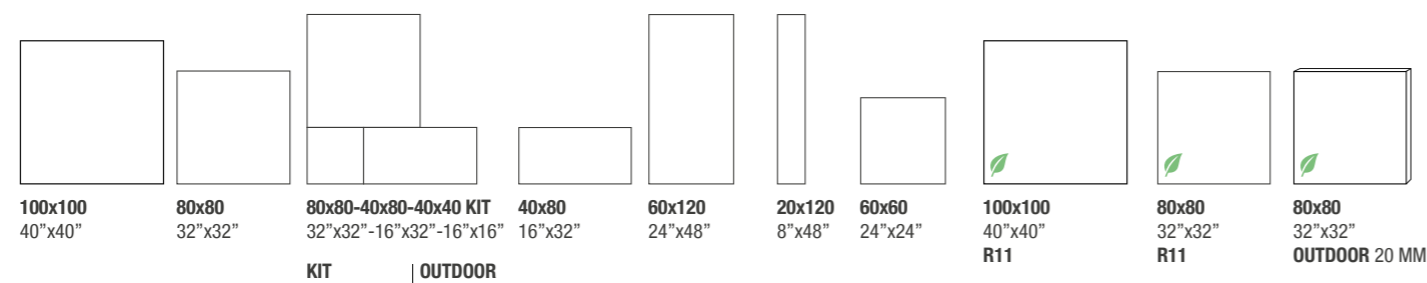

	CALCE	74503	74513	74533	74773	74523	74543	74553	74763	74743	74593	74603
	CEMENTO	74502	74512	74532	74772	74522	74542	74552	74762	74742	74592	74602

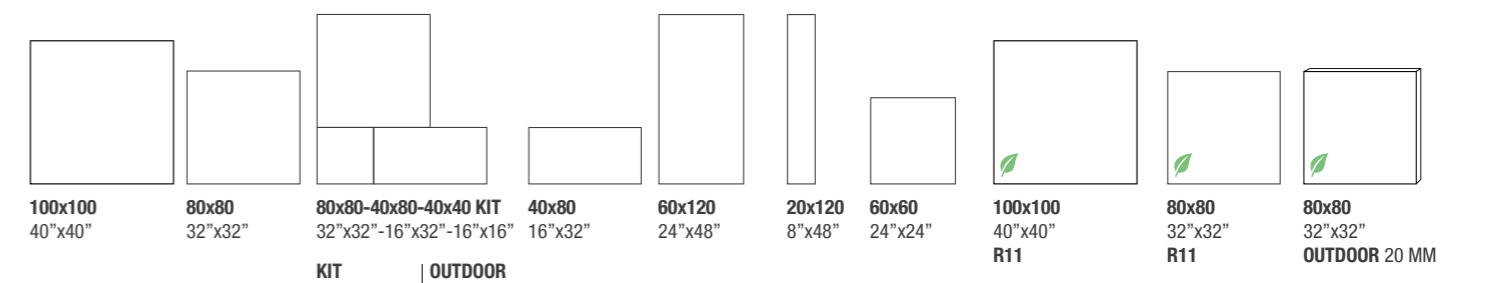

	POLVERE	74500	74510	74530	74770	74520	74540	74550	74760	74740	74590	74600
	FANGO	74501	74511	74531	74771	74521	74541	74551	74761	74741	74591	74601

DECORO RIVESTIMENTO GESSATO 20x120 (mix 3 soggetti)



20x120
WALL DEK CALCE
74583



20x120
WALL DEK CEMENTO
74582



20x120
WALL DEK POLVERE
74580



20x120
WALL DEK FANGO
74581

DECORO AFFRESCO



60x120 DECORO AFFRESCO POLVERE
74610



SCHEMI DI POSA - KIT 80x80 40x80 40x40

LAYING SOLUTIONS . VERLEGUNGSLÖSUNGEN . SCHEMA DE POSE . ESQUEMA DE MONTAJE . СХЕМЫ УКЛАДКИ . 铺装图

MODULO A

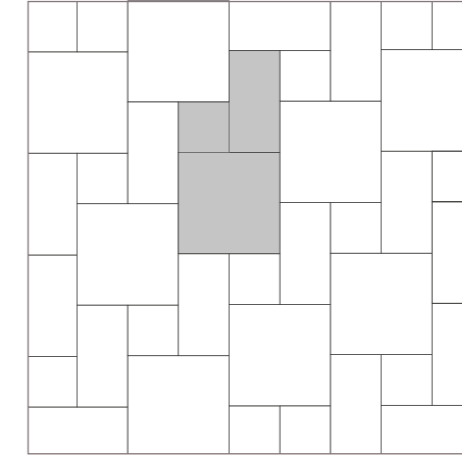

MODULO B

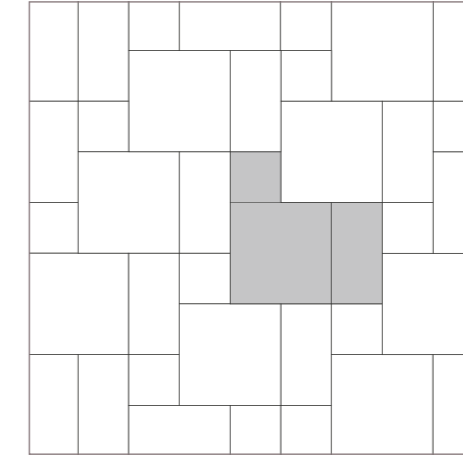

MODULO C

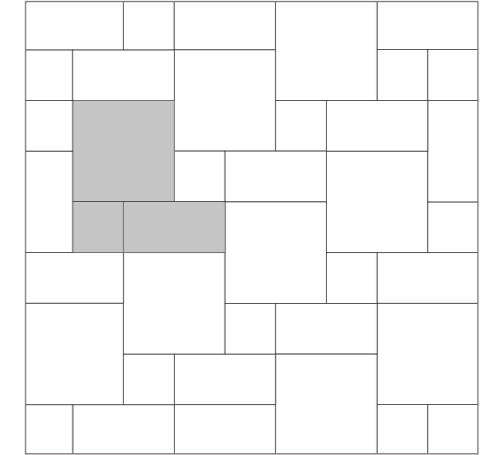

MOSAICI E PEZZI SPECIALI

SPECIAL TRIMS . PIECES SPECIALES . SONDERSTÜCKE
PIEZAS ESPECIALES . СПЕЦИАЛЬНЫЕ ИЗДЕЛИЯ . 特别装饰

	MOSAICO SPACCATELLA 30x30	MATTONCINO BURATTATO 10x30	BATTISCOPA MOLATO			GRADONE 120x32x4	GRADONE ANGOLARE 120x32x4	PROFILI IN FERRO	PROFILI ACCIAIO
			8x60	8x80	8x100				
CALCE	74633	74623	ML74763	ML74513	ML74503	74643	74663 SX 74653 DX	73601 2x100 73600 1x100	119862 1x80 26230 1x60
CEMENTO	74632	74622	ML74762	ML74512	ML74502	74642	74662 SX 74652 DX	119860 0,5x80 26235 0,5x60	119860 0,5x80 26235 0,5x60
POLVERE	74630	74620	ML74760	ML74510	ML74500	74640	74660 SX 74650 DX		
FANGO	74631	74621	ML74761	ML74511	ML74501	74641	74661 SX 74651 DX		

	ELEMENTO AD "L" 80x32x4 OUTDOOR 9 MM	ELEMENTO AD "L" 100x32x4 OUTDOOR 9 MM	ELEMENTO AD "L" 80x32x4 OUTDOOR 20 MM	GRADONE ARROTONDATO 80X40 OUTDOOR 20 MM	GRADONE BECCO CIVETTA 80X40 OUTDOOR 20 MM	ANGOLARE BORDO ARROTONDATO (KIT DX/SX) 160X40 OUTDOOR 20 MM	ANGOLARE BECCO CIVETTA (KIT DX/SX) 160X40 OUTDOOR 20 MM
CALCE	74673	74753	74683	74703	74713	74723	74733
CEMENTO	74672	74752	74682	74702	74712	74722	74732
POLVERE	74670	74750	74680	74700	74710	74720	74730
FANGO	74671	74751	74681	74701	74711	74721	74731

Amboise

IMBALLI . PACKING . CONDITIONNEMENT . VERPACKUNGSEINHEITEN . EMBALAJES . УПАКОВКА . 包裝

EN 14411/G Bla

FORMATO SIZE	SPESSORE THICKNESS	PZ/SCAT. PCS/BOX	MQ/SCAT. SQM/BOXT	KG/SCAT. KG/BOX	SCAT./PAL BOX/PAL	MQ/PAL SQM/PAL	KG/PAL
100x100	9 mm	2	2,000	39,60	24	48,00	950,40
80x80	9 mm	2	1,280	24,50	40	51,20	980,00
60x60	9 mm	3	1,080	21,25	40	43,20	850,00
KIT 80x80-40x80-40x40	9 mm	3	1,120	21,50	40	44,80	860,00
40x80	9 mm	4	1,280	25,20	27	34,56	690,61
60x120	9 mm	2	1,440	29,52	26	37,44	767,52
DECORO WALL DEK 20x120	9 mm	5	1,200	24,16	48	57,60	1159,68
DECORO 60x120	9 mm	2	1,440	29,52	-	-	-
MATTONCINO 10x30	9 mm	8	0,240	5,00	-	-	-
MOSAICO 30x30	9 mm	4	0,360	9,20	-	-	-
BATTISCOPA 8x100	9 mm	4	4,00 ml	7,36	-	-	-
BATTISCOPA 8x80	9 mm	10	8,00 ml	15,62	-	-	-
BATTISCOPA 8x60	9 mm	10	6,00 ml	10,00	-	-	-
GRADONE 120x32x4	9 mm	2	2,40 ml	22,85	-	-	-
GRADONE ANGOLARE 120x32x4	9 mm	1	-	11,42	-	-	-
ELEMENTO L 80x32x4 OUTDOOR	9 mm	2	1,60 ml	10,00	-	-	-
ELEMENTO L 100x32x4 OUTDOOR	9 mm	2	2,00 ml	16,50	-	-	-
80x80 - OUTDOOR	20 mm	1	0,640	28,75	45	28,80	1293,75
ELEMENTO L 80x32x4 OUTDOOR	20 mm	2	-	14,00	-	-	-
GRADONE BORDO ARROTONDATO 80x40 OUTDOOR	20 mm	2	1,60 ml	29,00	-	-	-
GRADONE BECCO DI CIVETTA 80x40 OUTDOOR	20 mm	2	1,60 ml	29,00	-	-	-
ANGOLARE BORDO ARROTONDATO 80x40 OUTDOOR	20 mm	1	-	25,00	-	-	-
ANGOLARE BECCO DI CIVETTA 80x40 OUTDOOR	20 mm	1	-	25,00	-	-	-
PROFILI METALLO 0,5x60 - 1x60		6	3,60 ml	2,70	-	-	-
PROFILI METALLO 0,5x80 - 1x80		6	4,80 ml	3,00	-	-	-

I DATI RELATIVI A IMBALLAGGI E PESI POSSONO SUBIRE DELLE VARIAZIONI . INFORMATIONS AND DETAILS RELATED TO PACKAGING AND WEIGHT ARE SUBJECT TO CHANGE
 LES DONNÉES CONCERNANT EMBALLAGE ET POIDS SONT SUJETTES À VARIATIONS . DIE ANGABEN ÜBER VERPACKUNGEN UND GEWICHTE SIND NICHT BINDEND
 LOS DATOS RELACIONADOS CON EL EMBALAJE Y LOS PESOS PUEDEN ESTAR SUJETOS A CAMBIOS . ДАННЫЕ, ОТНОСЯЩИЕСЯ К УПАКОВКЕ И ВЕСУ, ПОДЛЕЖАТ ИЗМЕНЕНИЯМ
 与包装和重量有关的数据可能会更改



FLOOR: CEMENTO 100x100
 WALL: CALCE DECORO GESSATO 20x120 - CALCE 20x120

le Pietre

Burlington Stone

GRES FINE PORCELLANATO AD IMPASTO COLORATO

COLORBODY FINE PORCELAIN STONEWARE

GRES CÉRAMÉ TEINTÉ DANS LA MASSE

FEINSGEINZEUG MIT EINGEFÄRBTEN SCHERBEN

GRES PORCELÁNICO MASA COLOREADA

ОКРАШЕННЫЙ ПО ВСЕ ТОЛЩИНЕ КЕРАМОГРАНИТ

彩色坯体瓷质玻化上釉砖



TECNOLOGIA AD ALTA DEFINIZIONE
HIGH-DEFINITION TECHNOLOGY

MOSAICI E DECORI



2 SUPERFICI (NATURALI)

NATURAL SURFACES

SURFACES NATURELLES

NATÜRLICHE OBERFLÄCHEN

SUPERFICIES NATURALES

НАТУРАЛЬНАЯ ПОВЕРХНОСТЬ

天然表面



R10-R11

R10 GRUPPO B (INDOOR)

DCOF > 0,42

ASTM C1028 > 0,60

BCRA W.D. > 0,40

PTV FOUR 6 W.D. > 0,36

R11 GRUPPO B (OUTDOOR)

DCOF > 0,42

ASTM C1028 > 0,60

BCRA W.D. > 0,40

PTV FOUR 6 W.D. > 0,36

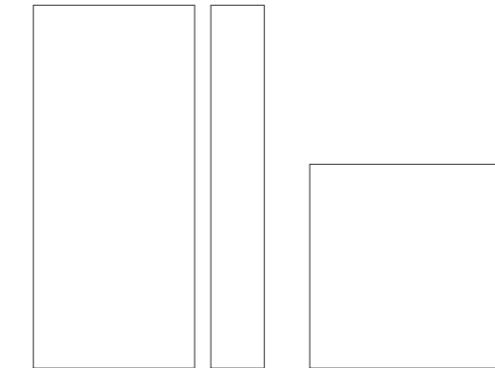

80x180
32"x72"

26,5x180
10¹/₂"x72"

100x100
40"x40"

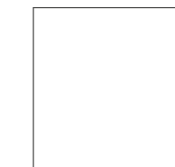

80x80
32"x32"

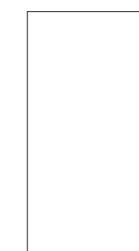

60x120
24"x48"

60x120
24"x48"



40x80
16"x32"



60x60
24"x24"



PEARL V2

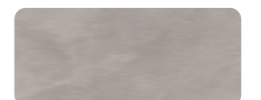

ROCK V2

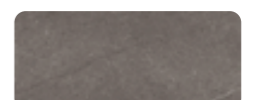

GRAPHITE V2



CREAM V2





FLOOR: ROCK 80x80



WALL: PEARL 80x180 - ROCK 80x180

Burlington Stone

le Pietre

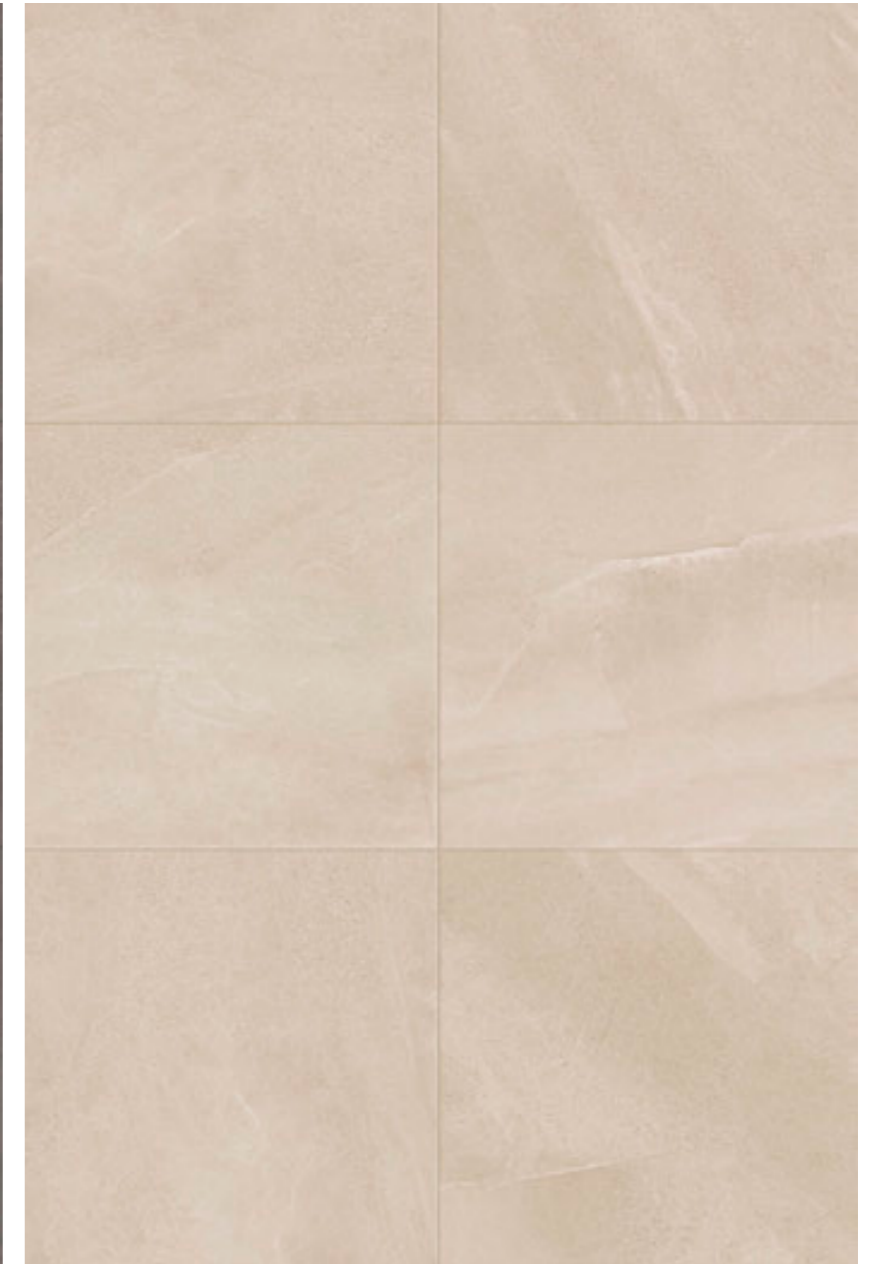
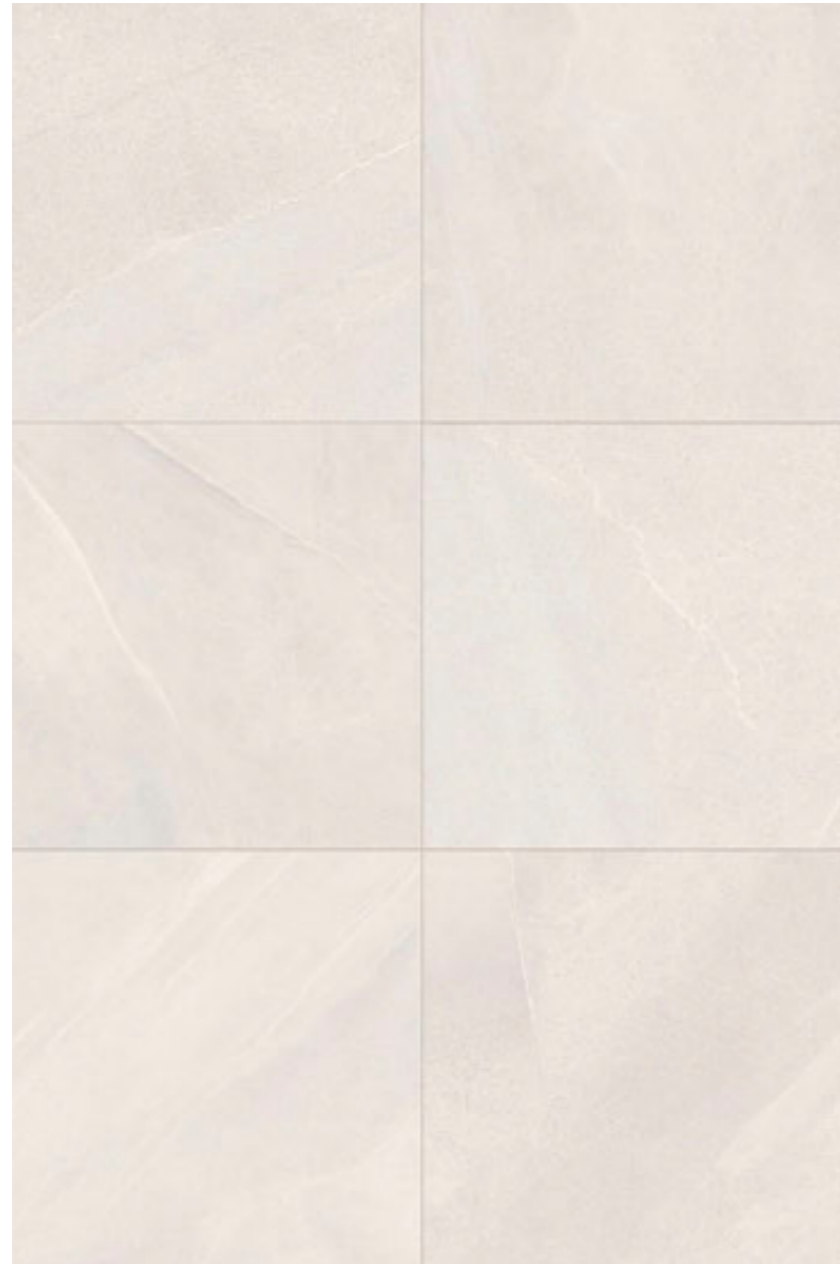

PEARL

ROCK

GRAPHITE

CREAM

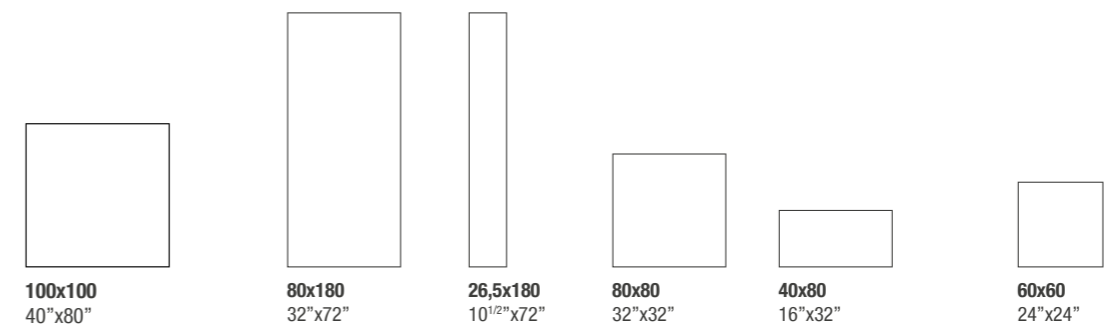
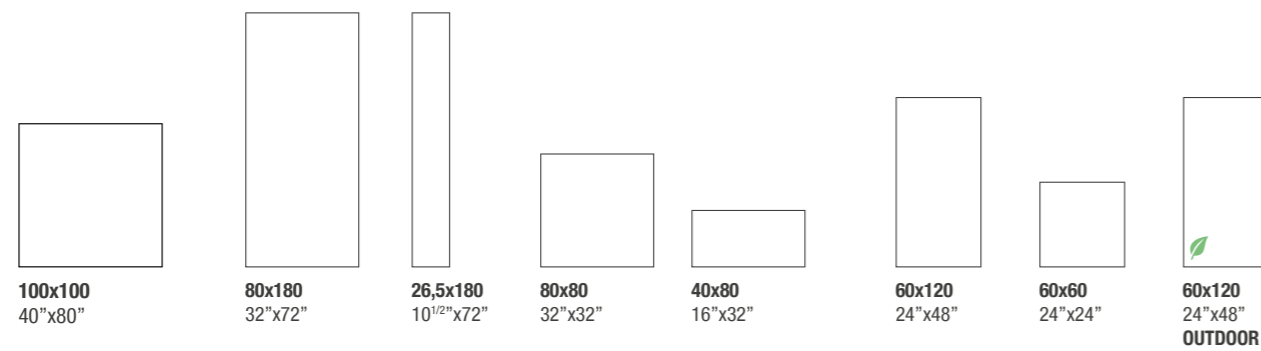

	PEARL	55510	55410	55420	55300	55310	55430	55450	55440
	ROCK	55512	55412	55422	55302	55312	55432	55452	55442

	GRAPHITE	55513	55413	55423	55303	55313	55453
	CREAM	55511	55411	55421	55301	55311	55451

Burlington Stone

MOSAICI E PEZZI SPECIALI

SPECIAL TRIMS . PIECES SPECIALES . SONDERSTÜCKE
PIEZAS ESPECIALES . СПЕЦИАЛЬНЫЕ ИЗДЕЛИЯ . 特别装饰

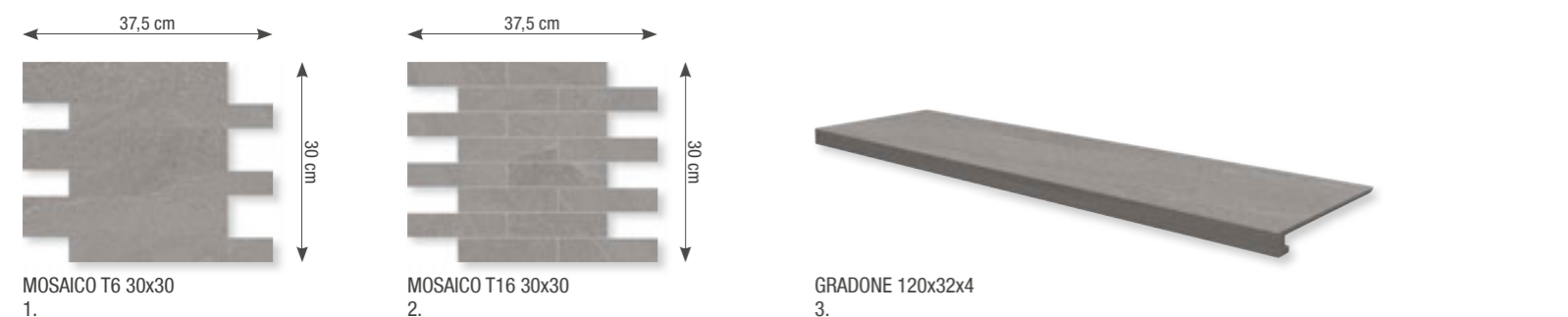

	MOSAICO T6 30x30	MOSAICO T16 30x30	BATTISCOPA MOLATO 8x80	GRADONE 120x32x4	GRADONE ANGOLARE 120x32x4	ELEMENTO "L" 120x32x4	PROFILI OTTONE	PROFILI ACCIAIO
PEARL	55380	55390	ML55300	55460	55470 DX 55480 SX	55490	119863 1x80 26231 1x60	119862 1x80 26230 1x60
ROCK	55382	55392	ML55302	55462	55472 DX 55482 SX	55492	119861 0,5x80 26236 0,5x60	119860 0,5x80 26235 0,5x60
GRAPHITE	55383	55393	ML55303	55463	55473 DX 55483 SX			
CREAM	55381	55391	ML55301	55461	55471 DX 55481 SX			

IMBALLI . PACKING . CONDITIONNEMENT . VERPACKUNGSEINHEITEN . EMBALAJES . УПАКОВКА . 包裝

EN 14411 B1a UGL

FORMATO SIZE	SPESSORE THICKNESS	PZ/SCAT. PCS/BOX	MQ/SCAT. SQM/BOXT	KG/SCAT. KG/BOX	SCAT./PAL BOX/PAL	MQ/PAL SQM/PAL	KG/PAL
100x100	9 mm	2	2,000	39,60	24	48,00	950,40
80x180	9 mm	2	2,880	55,25	20	57,60	1105,00
26,5x180	9 mm	3	1,431	32,20	36	51,51	1159,20
80x80	9 mm	2	1,280	24,50	40	51,20	980,00
40x80 Versione G	9 mm	4	1,280	25,20	27	34,56	680,61
60x120	9 mm	2	1,440	28,00	21	30,24	588,00
60x60	9 mm	3	1,080	21,25	40	43,20	850,00
MOSAICI 30x30	9 mm	4	-	9,20	-	-	-
BATTISCOPA MOLATO 8x80	9 mm	10	8,00 ml	15,00	-	-	-
GRADONE 120x32x4	9 mm	2	2,40 ml	22,85	-	-	-
GRADONE ANGOLARE 120x32x4	9 mm	1	-	11,42	-	-	-
ELEMENTO "L" 120x32x4 OUTDOOR	9 mm	2	2,40 ml	22,85	-	-	-
PROFILI METALLO 0,5x60 - 1x60	-	6	3,60 ml	2,70	-	-	-
PROFILI METALLO 0,5x80 - 1x80	-	6	4,80 ml	3,00	-	-	-

I DATI RELATIVI A IMBALLAGGI E PESI POSSONO SUBIRE DELLE VARIAZIONI . INFORMATIONS AND DETAILS RELATED TO PACKAGING AND WEIGHT ARE SUBJECT TO CHANGE
LES DONNÉES CONCERNANT EMBALLAGE ET POIDS SONT SUJETTES À VARIATIONS . DIE ANGABEN ÜBER VERPACKUNGEN UND GEWICHTE SIND NICHT BINDEND
LOS DATOS RELACIONADOS CON EL EMBALAJE Y LOS PESOS PUEDEN ESTAR SUJETOS A CAMBIOS . ДАННЫЕ, ОТНОСЯЩИЕСЯ К УПАКОВКЕ И ВЕСУ, ПОДЛЕЖАТ ИЗМЕНЕНИЯМ
与包装和重量有关的数据可能会更改



WALL: CREAM 40x80



le Pietre

Concept Stone

GRES FINE PORCELLANATO AD IMPASTO COLORATO

COLORBODY FINE PORCELAIN STONEWARE

GRES CÉRAMÉ TEINTÉ DANS LA MASSE

FEINSGEINZEUG MIT EINGEFÄRBTEN SCHERBEN

GRES PORCELÁNICO MASA COLOREADA

ОКРАШЕННЫЙ ПО ВСЕ ТОЛЩИНЕ КЕРАМОГРАНИТ

彩色坯体瓷质玻化上釉砖



TECNOLOGIA AD ALTA DEFINIZIONE
HIGH-DEFINITION TECHNOLOGY

MOSAICI E DECORI



2 SUPERFICI (NATURALI)

NATURAL SURFACES

SURFACES NATURELLES

NATÜRLICHE OBERFLÄCHEN

SUPERFICIES NATURALES

НАТУРАЛЬНАЯ ПОВЕРХНОСТЬ

天然表面



R10-R11

R10 GRUPPO B (INDOOR)

DCOF > 0,42

ASTM C1028 > 0,60

BCRA W.D. > 0,40

PTV FOUR 6 W.D. > 0,36

R11 GRUPPO B (OUTDOOR)

DCOF > 0,42

ASTM C1028 > 0,60

BCRA W.D. > 0,40

PTV FOUR 6 W.D. > 0,36

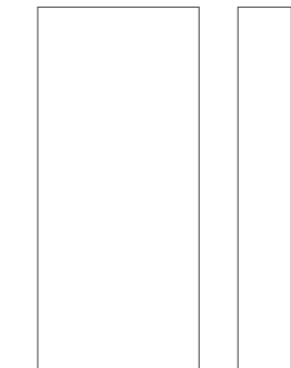

80x180
32"x72"

26,5x180
10^{1/2}"x72"

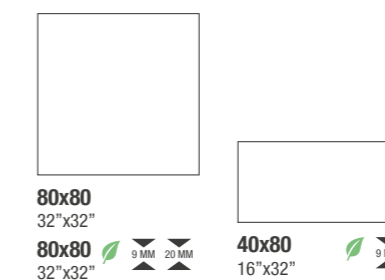

80x80
32"x32"

80x80 9 MM 20 MM
32"x32"

40x80 9 MM
16"x32"



BIANCO V2

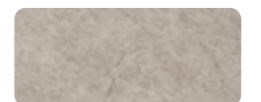

GRIGIO V2



ANTRACITE V3



NERO V2



BEIGE CHIARO V2



SABBIA V2



BRUNO MEDIO V2



FLOOR: BRUNO MEDIO 80x180
WALL: BEIGE CHIARO 80x180 - MODULO TRIANGOLI ORO 40x40

Concept Stone

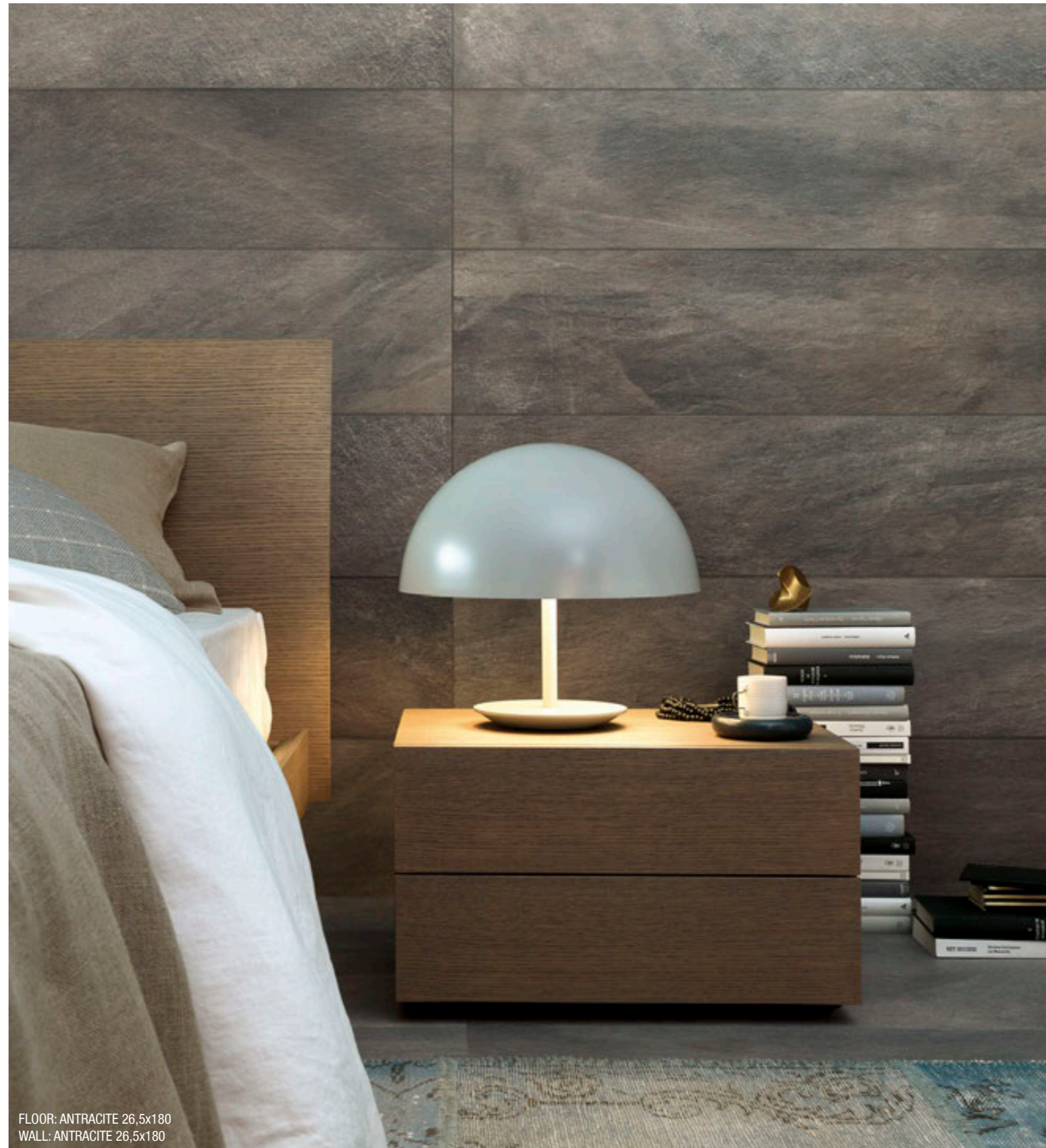

FLOOR: ANTRACITE 26,5x180
WALL: ANTRACITE 26,5x180



WALL: ANTRACITE 26,5x180



Concept Stone



BIANCO

GRIGIO

ANTRACITE

NERO

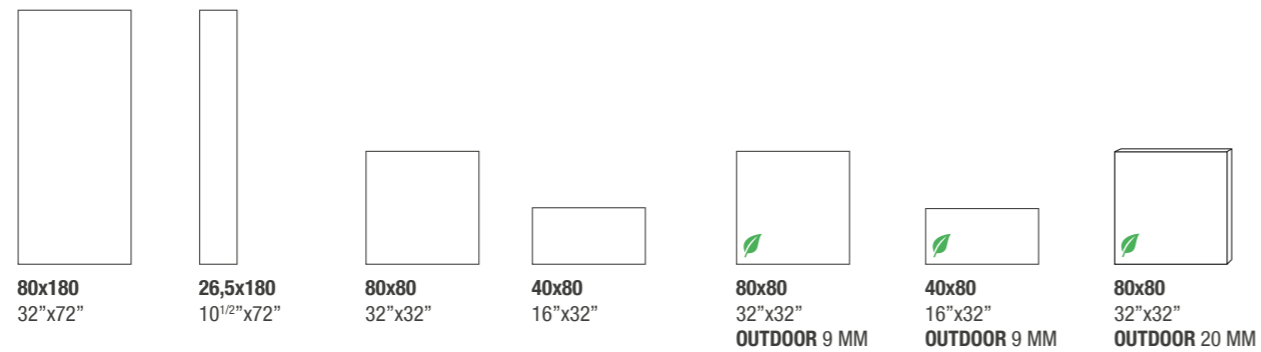

BIANCO	54200	54300	54100	54110			
GRIGIO	54203	54303	54103	54113	54463	54473	54123

ANTRACITE	54205	54305	54105	54115	54465	54475	54125
NERO	54206	54306	54106	54116			

Concept Stone



BEIGE CHIARO



SABBIA



BRUNO MEDIO

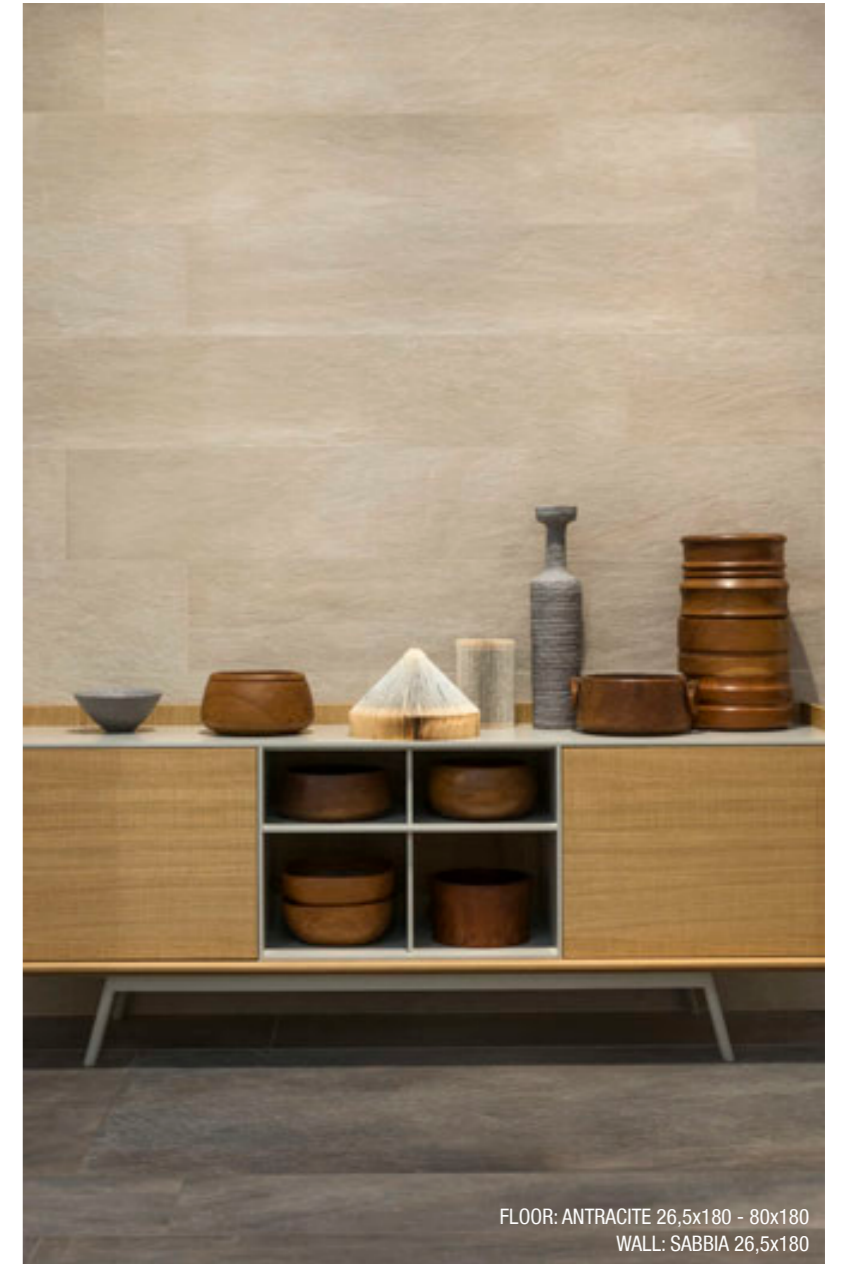

FLOOR: ANTRACITE 26,5x180 - 80x180
WALL: SABBIA 26,5x180

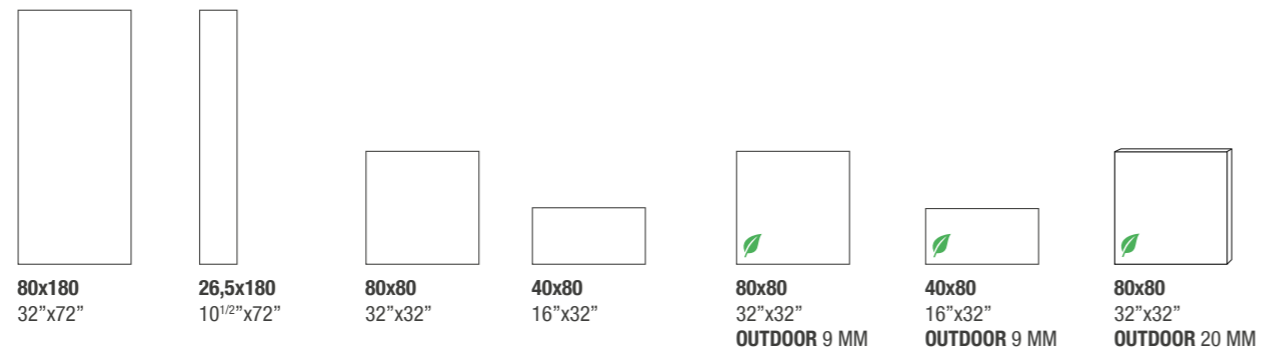

BEIGE CHIARO	54201	54301	54101	54111			
SABBIA	54202	54302	54102	54112	54462	54472	54122

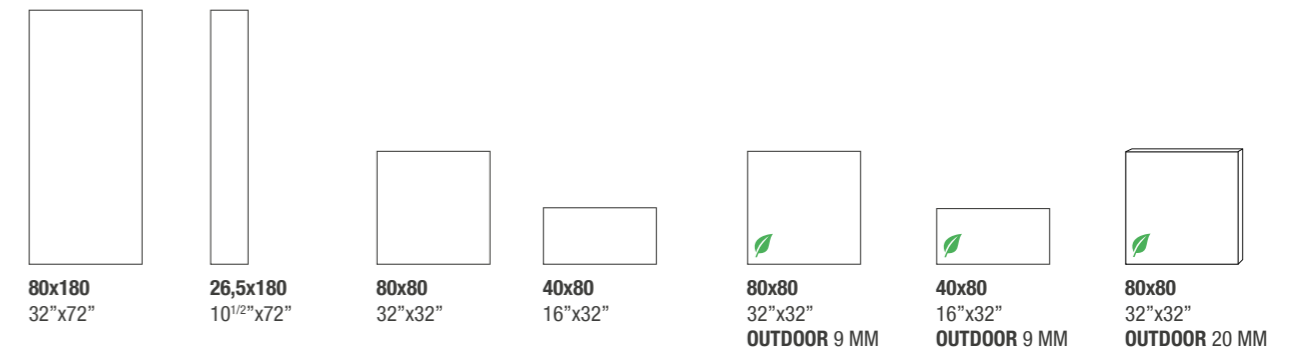

BRUNO MEDIO	54204	54304	54104	54114	54464	54474	54124
-------------	-------	-------	-------	-------	-------	-------	-------

Concept Stone

MOSAICO MURETTO / TRIANGOLI



40x40 BRUNO MEDIO / ORO
54444



40x40 ANTRACITE / ACCIAIO
54445

- 54441 BEIGE CHIARO / ORO
- 54442 SABBIA / ORO

- 54440 BIANCO / ACCIAIO
- 54443 GRIGIO / ACCIAIO
- 54446 NERO / ACCIAIO

MODULO TRIANGOLI



40x40 ACCIAIO
54420

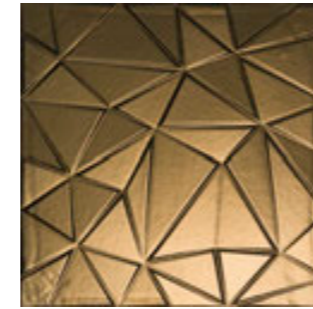

40x40 ORO
54421

OUTDOOR
TEXTURE 80x80 (mix 3 soggetti)



80x80 GRIGIO DECORATO
54133



80x80 SABBIA DECORATO
54132



80x80 ANTRACITE DECORATO
54135



80x80 BRUNO MEDIO DECORATO
54134



FLOOR: GRIGIO 26,5X180
WALL: BIANCO 26,5X180 - NERO 40X80

MOSAICI E PEZZI SPECIALI

SPECIAL TRIMS . PIECES SPECIALES . SONDERSTÜCKE
PIEZAS ESPECIALES . СПЕЦИАЛЬНЫЕ ИЗДЕЛИЯ . 特别装饰



MOSAICO MURETTO 40x40
1.



MOSAICO ESAGONI 37,5x37,5
2.



GRADONE 80x32x4
3.

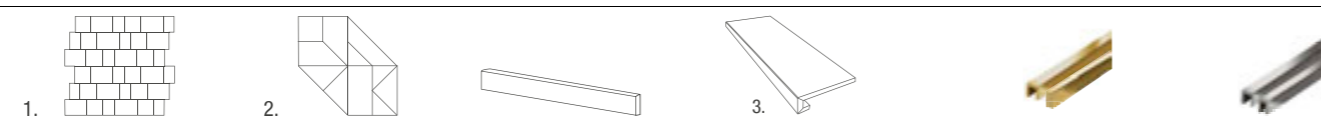

	MOSAICO 40x36	MOSAICO ESAGONI T11 30x30	BATTISCOPA 8x80	GRADONE 80x32x4	PROFILI OTTONE	PROFILI ACCIAIO
BIANCO	54430	54450	ML54100	54480	119863 1x80 26231 1x60	119862 1x80 26230 1x60
GRIGIO	54433	54453	ML54103	54483	119861 0,5x80 26236 0,5x60	119860 0,5x80 26235 0,5x60
ANTRACITE	54435	54455	ML54105	54485		
NERO	54436	54456	ML54106	54486		
BEIGE CHIARO	54431	54451	ML54101	54481		
SABBIA	54432	54452	ML54102	54482		
BRUNO MEDIO	54434	54454	ML54104	54484		



	ELEMENTO "L" 80X32X4 OUTDOOR 20 MM	GRADONE BORDO ARROTONDATO 80X40 OUTDOOR 20 MM	GRADONE BECCO CIVETTA 80X40 OUTDOOR 20 MM	ANGOLARE BORDO ARROTONDATO (KIT DX/SX) 160X40 OUTDOOR 20 MM	ANGOLARE BECCO CIVETTA (KIT DX/SX) 160X40 OUTDOOR 20 MM
GRIGIO	54083	53903	53913	53923	53933
ANTRACITE	54085	53905	53915	53925	53935
SABBIA	54082	53902	53912	53922	53932
BRUNO MEDIO	54084	53914	53914	53924	53934

IMBALLI . PACKING . CONDITIONNEMENT . VERPACKUNGSEINHEITEN . EMBALAJES . УПАКОВКА . 包装

EN 14411/G Bla

FORMATO SIZE	SPESSORE THICKNESS	PZ/SCAT. PCS/BOX	MQ/SCAT. SQM/BOXT	KG/SCAT. KG/BOX	SCAT./PAL BOX/PAL	MQ/PAL SQM/PAL	KG/PAL
80x180	9 mm	2	2,880	55,25	20	57,60	1105,00
80x80	9 mm	2	1,280	24,50	40	51,20	980,00
26,5x180	9 mm	3	1,431	30,60	42	60,10	1285,20
40x80	9 mm	4	1,280	25,20	27	34,56	1209,98
MOSAICI 40x36 / 37,5x37,5	9 mm	4	-	12,50	-	-	-
MODULO 40x40	9 mm	4	-	15,00	-	-	-
BATTISCOPA 8x80	9 mm	10	8,00 ml	15,00	-	-	-
GRADONE 80x32x4	9 mm	2	1,60 ml	14,00	-	-	-
80x80 OUTDOOR	20 mm	1	0,640	28,75	45	28,80	1293,75
ELEMENTO "L" 80x32x4 OUTDOOR	20 mm	2	1,60 ml	14,00	-	-	-
GRADONE BORDO ARROTONDATO 80x40 OUTDOOR	20 mm	2	1,60 ml	29,00	-	-	-
GRADONE BECCO DI CIVETTA 80x40 OUTDOOR	20 mm	2	1,60 ml	29,00	-	-	-
ANGOLARE BORDO ARROTONDATO 80x40 OUTDOOR	20 mm	1	-	25,00	-	-	-
ANGOLARE BECCO DI CIVETTA 80x40 OUTDOOR	20 mm	1	-	25,00	-	-	-
PROFILI METALLO 0,5x60 - 1x60	-	6	3,60 ml	2,70	-	-	-
PROFILI METALLO 0,5x80 - 1x80	-	6	4,80 ml	3,00	-	-	-

I DATI RELATIVI A IMBALLAGGI E PESI POSSONO SUBIRE DELLE VARIAZIONI . INFORMATIONS AND DETAILS RELATED TO PACKAGING AND WEIGHT ARE SUBJECT TO CHANGE
LES DONNÉES CONCERNANT EMBALLAGE ET POIDS SONT SUJETTES À VARIATIONS . DIE ANGABEN ÜBER VERPACKUNGEN UND GEWICHTE SIND NICHT BINDEND
LOS DATOS RELACIONADOS CON EL EMBALAJE Y LOS PESOS PUEDEN ESTAR SUJETOS A CAMBIOS . ДАННЫЕ, ОТНОСЯЩИЕСЯ К УПАКОВКЕ И ВЕСУ, ПОДЛЕЖАТ ИЗМЕНЕНИЯМ
与包装和重量有关的数据可能会更改



FLOOR - WALL: NERO 26,5X180

le Pietre

Esedra 2.0

GRES FINE PORCELLANATO AD IMPASTO COLORATO

COLORBODY FINE PORCELAIN STONEWARE

GRES CÉRAME TEINTÉ DANS LA MASSE

FEINSGEINZEUG MIT EINGEFÄRBTEN SCHERBEN

GRES PORCELÁNICO MASA COLOREADA

ОКРАШЕННЫЙ ПО ВСЕ ТОЛЩИНЕ КЕРАМОГРАНИТ

彩色坯体瓷质玻化上釉砖



TECNOLOGIA AD ALTA DEFINIZIONE
HIGH-DEFINITION TECHNOLOGY

MOSAICI E DECORI



2 SUPERFICI (NATURALI)

NATURAL SURFACES

SURFACES NATURELLES

NATÜRLICHE OBERFLÄCHEN

SUPERFICIES NATURALES

НАТУРАЛЬНАЯ ПОВЕРХНОСТЬ

天然表面



R10

R10 GRUPPO B (INDOOR)

DCOF > 0,42

ASTM C1028 > 0,60

BCRA W.D. > 0,40

PTV FOUR 6 W.D. > 0,36

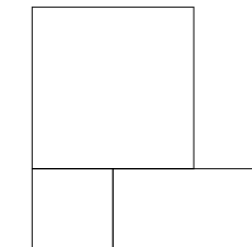

80x80 32"x32"
40x80 16"x32"
40x40 16"x16"

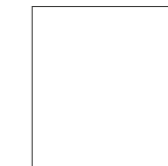

80x80
32"x32"



20x80
8"x32"



40x80
16"x32"



BIANCO V4



GRIGIO V4



CREMA V4



NOCE V4



WALL: CREMA 40x80 - CREMA 20x80 - FASCIA SABBIAITA CREMA 10x40 - TORELLO CREMA 5x40 - COLONNA CREMA 20x40
FLOOR: CREMA 80x80



FLOOR: CREMA 80x80
WALL: MATTONCINO BURATTATO NOCE 10x30 - MOSAICO SPACCATELLA NOCE 30x30



WALL: BIANCO 20x80 - BIANCO 40x80 - FASCIA SABBIAIA BIANCO 10x40
TORELLO BIANCO 5x40 - MOSAICO SPACCATELLA BIANCO 30x30
FLOOR: GRIGIO 80x80



WALL: BIANCO 20x40 - COLONNA BIANCO 20x40 - FASCIA RILIEVO BIANCO 10x40



WALL: BIANCO 20x40 - COLONNA BIANCO 20x40
MOSAICO SPACCAPELLA BIANCO 30x30 - FASCIA RILIEVO BIANCO 10x40
FLOOR: BIANCO 80x80



BIANCO

GRIGIO

CREMA

NOCE



80x80
32"x32"

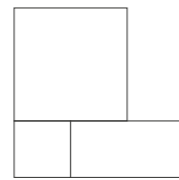

80x80-40x80-40x40
32"x32"-16"x32"-16"x16"
KIT



40x80
16"x32"

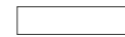

20x80
8"x32"



80x80
32"x32"

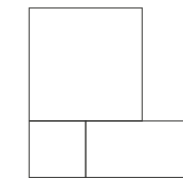

80x80-40x80-40x40
32"x32"-16"x32"-16"x16"
KIT



40x80
16"x32"

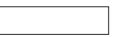

20x80
8"x32"

	BIANCO	76001	76121	76011	76021
	GRIGIO	76002	76122	76012	76022

	CREMA	76000	76120	76010	76020
	NOCE	76003	76123	76013	76023

FASCIA SABBATA



10x40 DEK BIANCO
76031



10x40 DEK GRIGIO
76032



10x40 DEK CREMA
76030



10x40 DEK NOCE
76033

TORELLO



5x40 TORELLO BIANCO
76041



5x40 TORELLO GRIGIO
76042



5x40 TORELLO CREMA
76040



5x40 TORELLO NOCE
76043

FASCIA RILIEVO



10x40 FASCIA RILIEVO BIANCO
76131



10x40 FASCIA RILIEVO GRIGIO/PLATINO
76132



10x40 FASCIA RILIEVO CREMA
76130



10x40 FASCIA RILIEVO NOCE/ORO
76133

COLONNA



20x40 COLONNA BIANCO
76051



20x40 COLONNA CREMA
76050

SCHEMI DI POSA - KIT 80x80 40x80 40x40

LAYING SOLUTIONS . VERLEGUNGSLÖSUNGEN . SCHEMA DE POSE . ESQUEMA DE MONTAJE . СХЕМЫ УКЛАДКИ . 铺装图

MODULO A

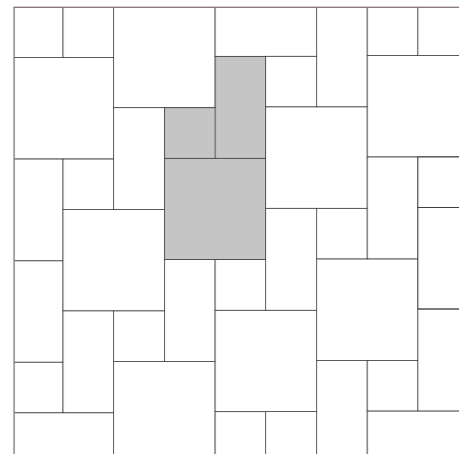

MODULO B

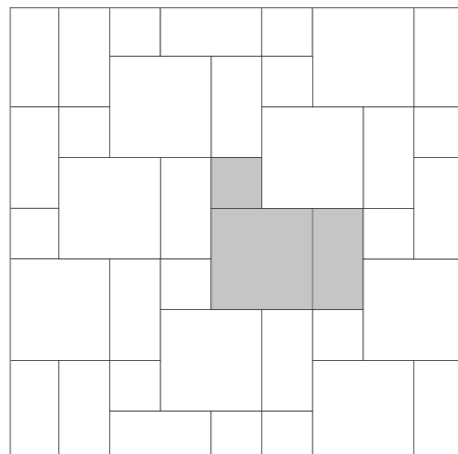

MODULO C

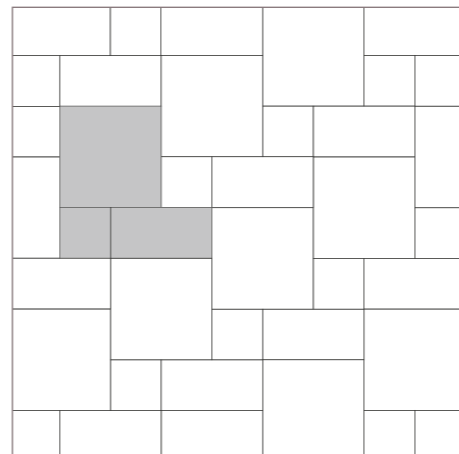

MOSAICI E PEZZI SPECIALI

SPECIAL TRIMS . PIECES SPECIALES . SONDERSTÜCKE
PIEZAS ESPECIALES . СПЕЦИАЛЬНЫЕ ИЗДЕЛИЯ . 特别装饰

	MATTONCINO BURATTATO 10x30	MOSAICO SPACCATELLA 30x30	BATTISCOPA MOLATO 8x80	GRADONE 80x32x4	GRADONE ANGOLARE 80x32x4	COPRISPIGOLO 1,2x40	PROFILI OTTONE (M)	PROFILI ACCIAIO (M)
	76061	76071	ML76001	76081	76101 Sx 76091 Dx	76141	119863 1x80 26231 1x60	119862 1x80 26230 1x60
	76062	76072	ML76002	76082	76102 Sx 76092 Dx	76142	119861 0,5x80 26236 0,5x60	119860 0,5x80 26235 0,5x60
	76060	76070	ML76000	76080	76100 Sx 76090 Dx	76140		
	76063	76073	ML76003	76083	76103 Sx 76093 Dx	76143		

IMBALLI . PACKING . CONDITIONNEMENT . VERPACKUNGSEINHEITEN . EMBALAJES . УПАКОВКА . 包裝

EN 14411/G Bla

FORMATO SIZE	SPESSORE THICKNESS	PZ/SCAT. PCS/BOX	MQ/SCAT. SQM/BOXT	KG/SCAT. KG/BOX	SCAT./PAL BOX/PAL	MQ/PAL SQM/PAL	KG/PAL
80x80	9 mm	2	1,280	24,50	40	51,20	980,00
40x80	9 mm	4	1,280	25,20	27	34,56	690,61
20x80	9 mm	6	0,960	18,75	36	34,56	675,00
KIT FONDI 80x80-40x80-40x40	9 mm	3	1,120	21,50	40	44,80	860,00
FASCIA 10x40	9 mm	6	2,40 ml	4,80	-	-	-
FASCIA RILIEVO 10x40	9 mm	6	2,40 ml	4,20	-	-	-
TORELLO 5x40	9 mm	5	2,00 ml	2,00	-	-	-
COLONNA 20x40	9 mm	3	-	9,60	-	-	-
MATTONCINO 10x30	9 mm	8	0,240 ml	5,00	-	-	-
MOSAICO 30x30	9 mm	4	0,360 ml	9,20	-	-	-
BATTISCOPA 8x80	9 mm	10	8,00 ml	12,00	-	-	-
GRADONE 120x32x4	9 mm	2	2,40 ml	22,85	-	-	-
GRADONE ANGOLARE 120x32x4	9 mm	1	-	11,42	-	-	-
COPRISPIGOLO 1,2x40	-	6	2,40 ml	0,33	-	-	-
PROFILI METALLO 0,5x60 - 1x60	-	6	3,60 ml	2,70	-	-	-
PROFILI METALLO 0,5x80 - 1x80	-	6	4,80 ml	3,00	-	-	-

I DATI RELATIVI A IMBALLAGGI E PESI POSSONO SUBIRE DELLE VARIAZIONI . INFORMATIONS AND DETAILS RELATED TO PACKAGING AND WEIGHT ARE SUBJECT TO CHANGE
LES DONNÉES CONCERNANT EMBALLAGE ET POIDS SONT SUJETTES À VARIATIONS . DIE ANGABEN ÜBER VERPACKUNGEN UND GEWICHTE SIND NICHT BINDEND
LOS DATOS RELACIONADOS CON EL EMBALAJE Y LOS PESOS PUEDEN ESTAR SUJETOS A CAMBIOS . ДАННЫЕ, ОТНОСЯЩИЕСЯ К УПАКОВКЕ И ВЕСУ, ПОДЛЕЖАТ ИЗМЕНЕНИЯМ
与包装和重量有关的数据可能会更改

le Pietre

Origini

GRES FINE PORCELLANATO AD IMPASTO COLORATO

COLORBODY FINE PORCELAIN STONEWARE
GRES CÉRAME TEINTÉ DANS LA MASSE
FEINSGEINZEUG MIT EINGEFÄRBTEN SCHERBEN
GRES PORCELÁNICO MASA COLOREADA
ОКРАШЕННЫЙ ПО ВСЕ ТОЛЩИНЕ КЕРАМОГРАНИТ
彩色坯体瓷质玻化上釉砖

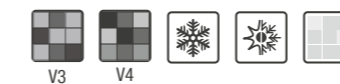

TECNOLOGIA AD ALTA DEFINIZIONE
HIGH-DEFINITION TECHNOLOGY

MOSAICI E DECORI



3 SUPERFICI (NATURALI - LAPPATO)

NATURAL SURFACES - SEMI-POLISHED SURFACE
SURFACES NATURELLES - SEMI-POLI
NATÜRLICHE OBERFLÄCHEN - ANPOLIERT OBERFLÄCHE
SUPERFICIES NATURALES - SEMI-PULIDO
НАТУРАЛЬНАЯ ПОВЕРХНОСТЬ - ПОЛУПОЛИРОВАННЫЙ
天然表面 - 抛光



R10-R11

R10 GRUPPO B (INDOOR)
DCOF > 0,42
ASTM C1028 > 0,60
BCRA W.D. > 0,40
PTV FOUR 6 W.D. > 0,36

R11 GRUPPO B (OUTDOOR)
DCOF > 0,42
ASTM C1028 > 0,60
BCRA W.D. > 0,40
PTV FOUR 6 W.D. > 0,36

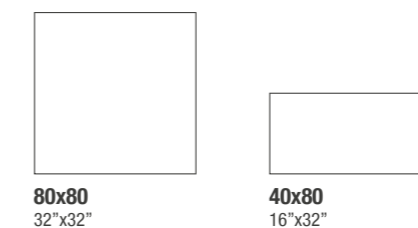
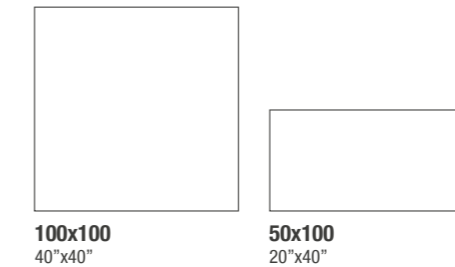

80x80
32"x32"

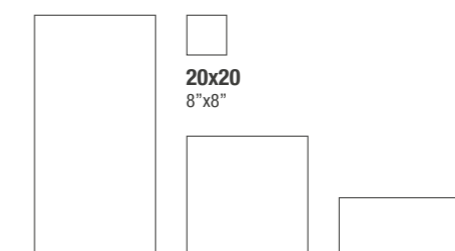

60x120 24"x48"
60x60 24"x24"
30x60 12"x24"



CRUX WHITE V3



CRUX GREY V4



GRIS ROYAL V3



BOLGHERI V3



AGE STONE V3



FLOOR: CRUX GREY LAP 100x100
WALL: CRUX WHITE 50x100
TABLE: GARDENIA SLABS T.U. BLACK NAT 160x320
COUNTER TOP: GARDENIA SLABS T.U. BLACK NAT 160x320





FLOOR: AGE STONE 100x100
WALL: CRUX WHITE 50x100 - CRUX WHITE MOSAICO SPACCATO 32,5x34,5



FLOOR: AGE STONE 100x100
WALL: CRUX WHITE 50x100 - AGE STONE 20x20





CRUX WHITE *



CRUX GREY *

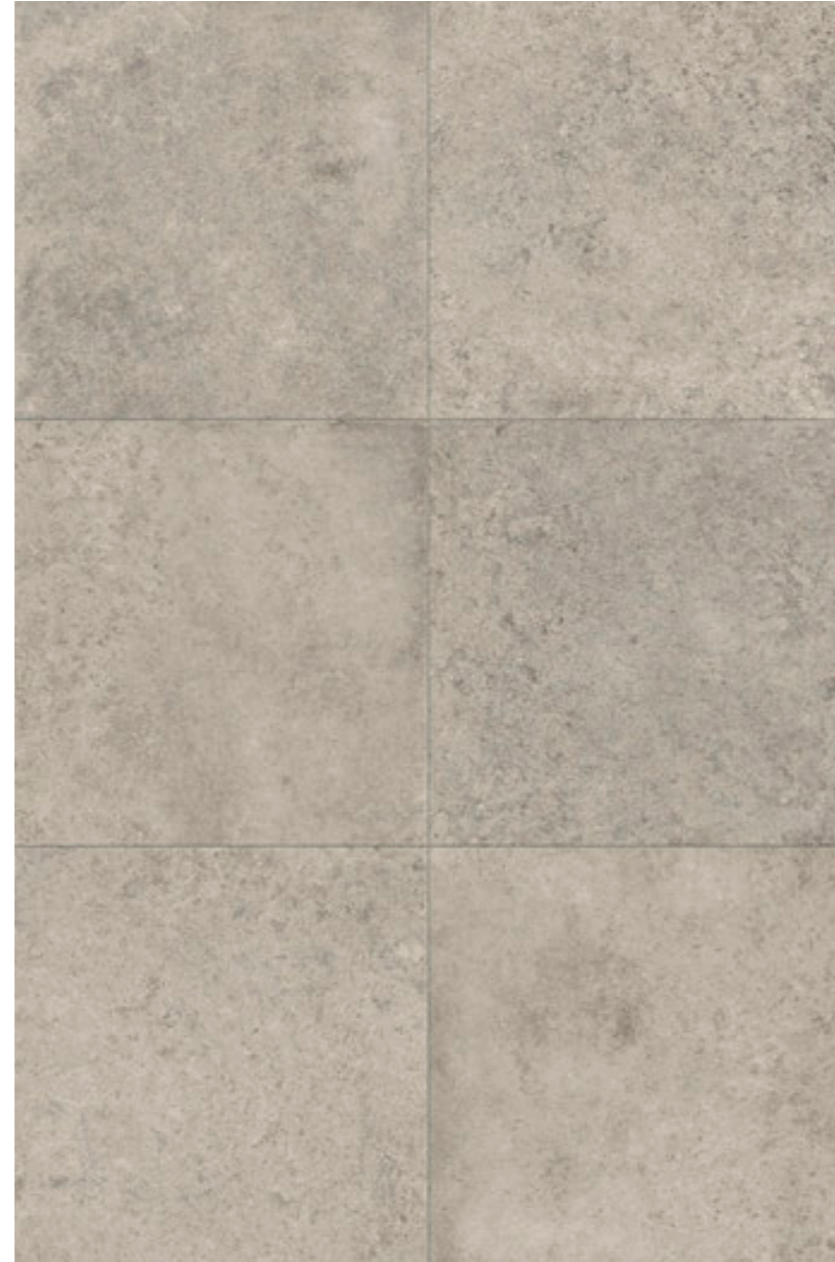

GRIS ROYAL



BOLGHERI

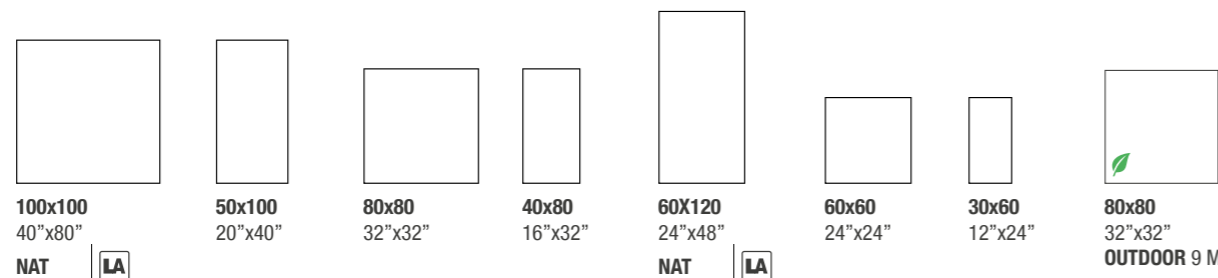

		100x100 40"x80"	50x100 20"x40"	80x80 32"x32"	40x80 16"x32"	60x120 24"x48"	60x60 24"x24"	30x60 12"x24"	80x80 32"x32"		
	NAT								OUTDOOR 9 MM		
	LA										
	CRUX WHITE	73542	73802	73532	73522	73512	73592	73832	73582	73572	73702
	CRUX GREY	73541	73801	73531	73521	73511	73591	73831	73581	73571	73701

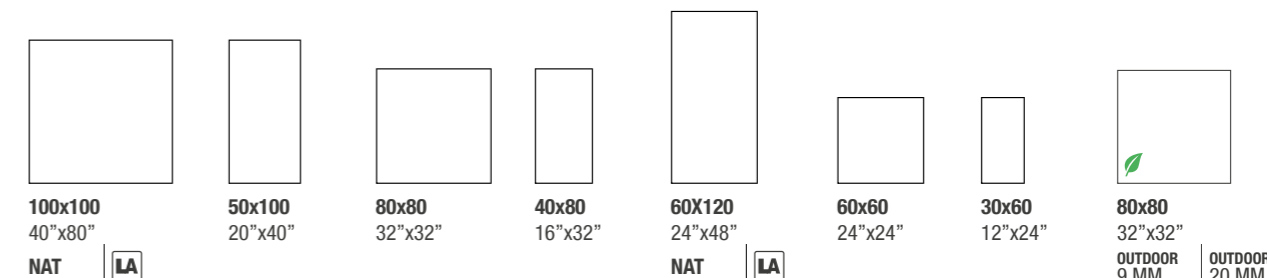

		100x100 40"x80"	50x100 20"x40"	80x80 32"x32"	40x80 16"x32"	60x120 24"x48"	60x60 24"x24"	30x60 12"x24"	80x80 32"x32"			
	NAT								OUTDOOR 9 MM			
	LA								OUTDOOR 20 MM			
	GRIS ROYAL	73544	73804	73534	73524	73514	73594	73834	73584	73574	73704	73554
	BOLGHERI	73543	73803	73533	73523	73513	73593	73833	73583	73573	73703	-

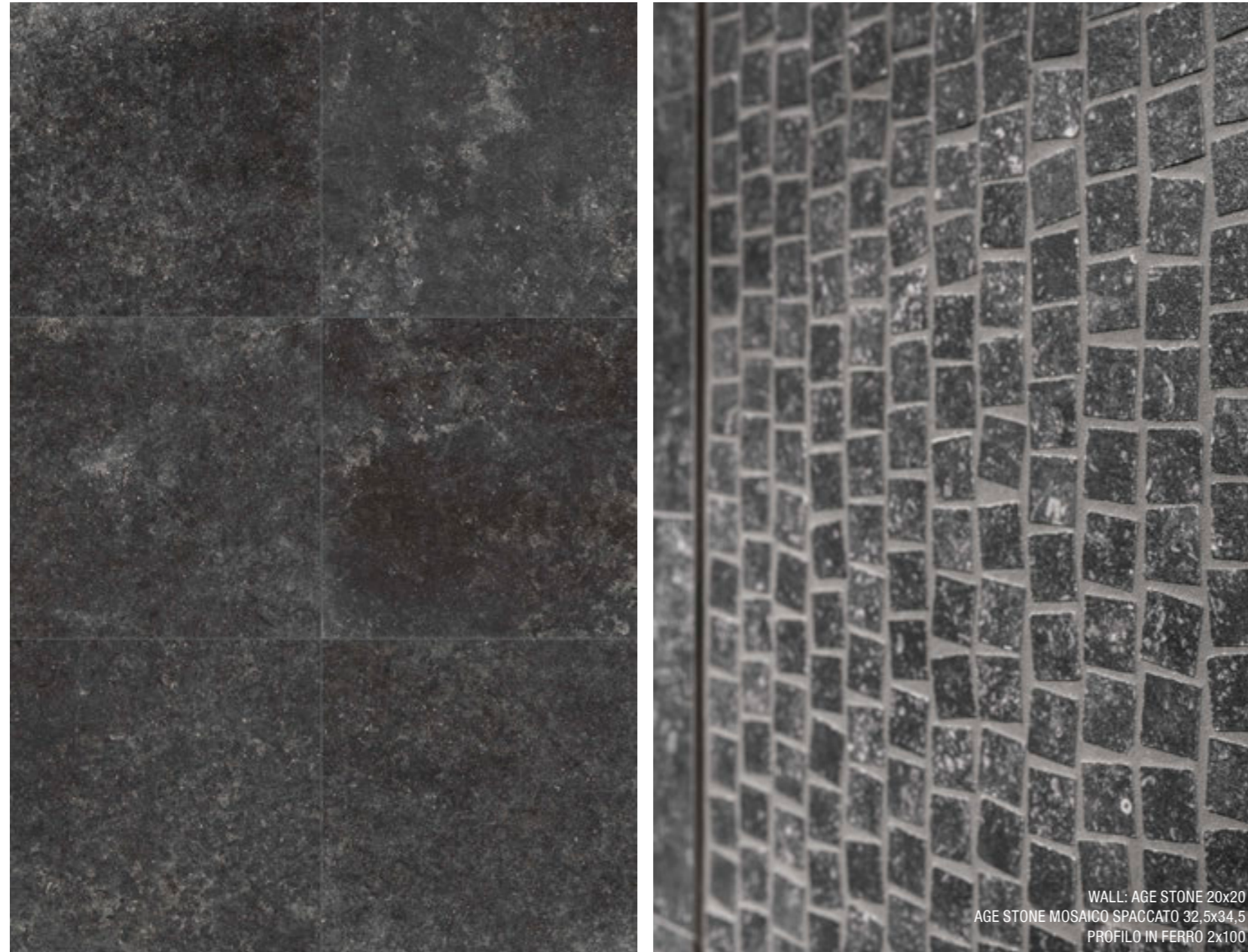

AGE STONE

WALL: AGE STONE 20x20
AGE STONE MOSAICO SPACCATO 32,5x34,5
PROFILO IN FERRO 2x100

100x100 40"x80"	50x100 20"x40"	80x80 32"x32"	40x80 16"x32"	60x120 24"x48"	60x60 24"x24"	30x60 12"x24"	20x20 8"x8"	80x80 32"x32" OUTDOOR 20 MM			
NAT	LA			NAT	LA						
AGE STONE	73540	73800	73530	73520	73510	73590	73830	73580	73570	73820	73550

MOSAICI E PEZZI SPECIALI

SPECIAL TRIMS . PIECES SPECIALES . SONDERSTÜCKE
PIEZAS ESPECIALES . СПЕЦИАЛЬНЫЕ ИЗДЕЛИЯ . 特别装饰

	MOSAICO T36 33,3x33,3	MOSAICO SPACCATO 32,5x34,5	8x60	8x80	8x100	GRADONE 120x32x4	GRADONE ANGOLARE 120x32x4	PROFILO IN FERRO
	CRUX WHITE	73772	73782	ML73582	ML73522	ML73542	73712	73722 Sx 73732 Dx 73601 2x100 73600 1x100
	CRUX GREY	73771	73781	ML73581	ML73521	ML73541	73711	73721 Sx 73731 Dx
	GRIS ROYAL	73774	73784	ML73584	ML73524	ML73544	73714	73724 Sx 73734 Dx
	BOLGHERI	73773	73783	ML73583	ML73523	ML73543	73713	73723 Sx 73733 Dx
	AGE STONE	73770	73780	ML73580	ML73520	ML73540	73710	73720 Sx 73730 Dx

* Il Crux è caratterizzato da forte stonizzazione, si consiglia di scegliere da più scatole contemporaneamente e di posare una porzione di materiale a secco per garantire la variabilità e casualità della superficie finita. • Crux has a strong graphic variation, we recommend to choose few pieces at the same time from different boxes and to lay them dry first in order to grant the correct variability and randomness as an end result. • Le Crux est un produit fort nuancé. Nous conseillons, au moment de la pose, de sortir les carreaux de plusieurs boîtes en même temps et de poser une portion de sol avant encollage pour garantir la variabilité et causalité de la surface posée. • Das Crux zeichnet sich durch ein starkes Farbspiel aus, es ist empfehlenswert, aus mehreren Kartons gleichzeitig zu wählen und einen Teil des Materials ohne Klebstoff zu verlegen, um die Variabilität und Zufälligkeit der fertigen Oberfläche zu gewährleisten. • El Crux es un producto muy destinalizado, nosotros recomendamos de elegir algunas piezas de diferentes cajas al mismo tiempo y de colocarle ante de pegar para asegurar la variabilidad y casualidad del resultado final. • Crux продукт с сильными цветовыми изменениями. Для оптимальной укладки необходимо смешивать плитки из разных коробок и сделать пробную укладку на сухую, чтобы гарантировать большую вариабильность поверхности. • 克拉克灰色具有很强的石材效果，为了突出铺贴后的多面性及随机性，建议同时从多个包装箱中取出材料并事先干铺一部分。

	ELEMENTO "L" 80x32x4 OUTDOOR	ELEMENTO "L" 80x32x4 OUTDOOR 20 MM	GRADONE ARROTONDATO 80x40 OUTDOOR 20 MM	GRADONE BECCO CIVETTA 80x40 OUTDOOR 20 MM	ANGOLARE BORDO ARROTONDATO (KIT DX/SX) 160x40 OUTDOOR 20 MM	ANGOLARE BECCO CIVETTA (KIT DX/SX) 160x40 OUTDOOR 20 MM	
	CRUX WHITE	-	-	-	-	-	
	CRUX GREY	-	-	-	-	-	
	GRIS ROYAL	73744	73764	73864	73874	73884	73894
	BOLGHERI	73743	-	-	-	-	-
	AGE STONE	-	73760	73860	73870	73880	73890

Origini

IMBALLI . PACKING . CONDITIONNEMENT . VERPACKUNGSEINHEITEN . EMBALAJES . УПАКОВКА . 包裝

EN 14411/UGL Bla

FORMATO SIZE	SPESSORE THICKNESS	PZ/SCAT. PCS/BOX	MQ/SCAT. SQM/BOXT	KG/SCAT. KG/BOX	SCAT./PAL BOX/PAL	MQ/PAL SQM/PAL	KG/PAL
100x100	9 mm	2	2,000	39,60	24	48,00	950,40
50x100	9 mm	4	2,000	39,60	24	48,00	950,40
80x80	9 mm	2	1,280	24,50	40	51,20	980,00
40x80	9 mm	4	1,280	25,20	27	34,56	690,61
60x120	9 mm	2	1,440	29,52	26	37,44	767,52
60x60	9 mm	3	1,080	21,25	40	43,20	850,00
30x60	9 mm	7	1,260	22,46	40	50,40	898,40
20x20	9 mm	25	1,000	19,80	42	42,00	831,60
MOSAICO T36 33,3x33,3	9 mm	4	0,443	9,60	-	-	-
MOSAICO SPACCATO 32,5x32,5	9 mm	4	0,422	9,00	-	-	-
BATTISCOPA 8x60	9 mm	10	6,00 ml	10,00	-	-	-
BATTISCOPA 8x80	9 mm	10	8,00 ml	12,00	-	-	-
BATTISCOPA 8x100	9 mm	4	4,00 ml	7,36	-	-	-
ELEMENTO AD "L" 80x32x4	9 mm	2	1,60 ml	14,00	-	-	-
GRADONE 120X32X4	9 mm	2	2,40 ml	22,85	-	-	-
ANGOLARE GRADONE 120x32x4	9 mm	1	-	11,42	-	-	-
80x80 - 20 MM	20 mm	1	0,640	28,75	45	28,80	1293,75
ELEMENTO AD "L" 80x32x4	20 mm	2	1,60 ml	14,00	-	-	-
GRADONE BORDO ARROTONDATO 80x40 OUTDOOR	20 mm	2	1,60 ml	29,00	-	-	-
GRADONE BECCO DI CIVETTA 80x40 OUTDOOR	20 mm	2	1,60 ml	29,00	-	-	-
ANGOLARE BORDO ARROTONDATO 80x40 OUTDOOR	20 mm	1	-	25,00	-	-	-
ANGOLARE BECCO DI CIVETTA 80x40 OUTDOOR	20 mm	1	-	25,00	-	-	-
PROFILO FERRO 2x100	-	4	4,00 ml	1,40	-	-	-
PROFILO FERRO 1x100	-	6	6,00 ml	1,40	-	-	-

I DATI RELATIVI A IMBALLAGGI E PESI POSSONO SUBIRE DELLE VARIAZIONI . INFORMATIONS AND DETAILS RELATED TO PACKAGING AND WEIGHT ARE SUBJECT TO CHANGE
 LES DONNÉES CONCERNANT EMBALLAGE ET POIDS SONT SUJETTES À VARIATIONS . DIE ANGABEN ÜBER VERPACKUNGEN UND GEWICHTE SIND NICHT BINDEND
 LOS DATOS RELACIONADOS CON EL EMBALAJE Y LOS PESOS PUEDEN ESTAR SUJETOS A CAMBIOS . ДАННЫЕ, ОТНОСЯЩИЕСЯ К УПАКОВКЕ И ВЕСУ, ПОДЛЕЖАТ ИЗМЕНЕНИЯМ
 与包装和重量有关的数据可能会更改



WALL: AGE STONE 20x20

le Pietre

Unique

GRES FINE PORCELLANATO AD IMPASTO COLORATO

COLORBODY FINE PORCELAIN STONEWARE
 GRES CÉRAMÉ TEINTÉ DANS LA MASSE
 FEINSGEINZEUG MIT EINGEFÄRBTEN SCHERBEN
 GRES PORCELÁNICO MASA COLOREADA
 ОКРАШЕННЫЙ ПО ВСЕ ТОЛЩИНЕ КЕРАМОГРАНИТ
 彩色坯体瓷质玻化上釉砖



TECNOLOGIA AD ALTA DEFINIZIONE
 HIGH-DEFINITION TECHNOLOGY

MOSAICI E DECORI



2 SUPERFICI (SOFT MATT - LAPPATO)

SOFT MATT - SEMI-POLISHED SURFACE
 SURFACE SOFT MATT - SEMI-POLI
 SOFT MATT - ANPOLIERT OBERFLÄCHE
 SUPERFICIE SOFT MATT - SEMI-PULIDO
 SOFT MATT - ПОЛУПОЛИРОВАННЫЙ
 SOFT MATT - 抛光



R10-R11

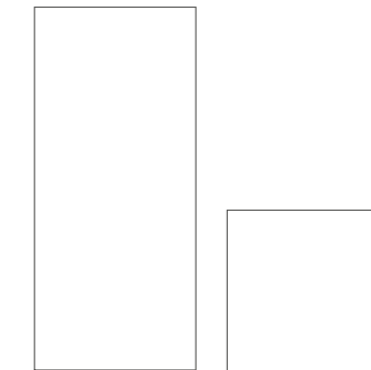

80x180
32"x72"

80x80
32"x32"



40x80
16"x32"

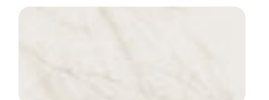

CALACATTA V3 ISO 5



PEARL V3 ISO 5



CREAM V3 ISO 5



BROWN ONIX V3 ISO 4



STATUARIO VENATO V3 ISO 5



INFINITY BLACK V3 ISO 3



FLOOR: INFINITY BLACK 80x80
WALL: STATUARIO 80x180 - DECORO ORGANIC BLACK / GOLD 80x180

Unique



WALL: STATUARIO VENATO 80x180



FLOOR: CALACATTA 80x180
WALL: CALACATTA 80x180 - DECORO LINEE 40x80

Unique



FLOOR: BROWN ONYX 80x80
WALL: BROWN ONYX 80x180 - CREAM 80x180 - FASCIA QUADRETTI BROWN ONIX 10x80



FLOOR: CREAM 80x80 - CASSETTONE 80x80
WALL: BROWN ONIX 40x80 - DECORO LINEE 40x80 - DECORO ORGANIC 80x180



CALACATTA



PEARL



CREAM



BROWN ONIX



80x180
32"x72"
LA





80x80
32"x32"
LA



40x80
16"x32"
LA



80x80
32"x32"
SOFT MATT

	CALACATTA	57664	57654	57754	57904
	PEARL	57660	57650	57750	57900

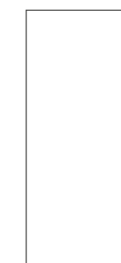

80x180
32"x72"
LA





80x80
32"x32"
LA



40x80
16"x32"
LA



80x80
32"x32"
SOFT MATT

	CREAM	57662	57652	57752	57902
	BROWN ONIX	57666	57656	57756	57906



STATUARIO VENATO

INFINITY BLACK



80x180
32"x72"
LA



80x80
32"x32"
LA



40x80
16"x32"
LA



80x80
32"x32"
SOFT MATT

STATUARIO VENATO	57661	57651	57751	57901
INFINITY BLACK	57667	57657	57757	57907

DECORI

DECORS / DÉCORATIONS / VERZIERUNGEN / DECORACIONES / УКРАШЕНИЯ / 装饰



80x80 CASSETTONE CALDO CALACATTA / CREAM / BROWN ONIX
57670



80x80 CASSETTONE FREDDO STATUARIO VENATO / GRIGIO / INFINITY BLACK
57671

DECORO LINEE (composizione 2 pz.)

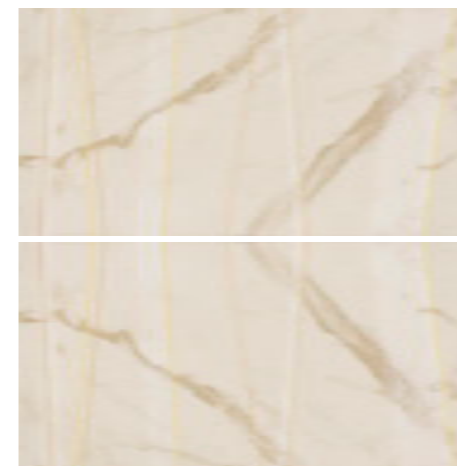

40x80 PEARL ONIX
57820

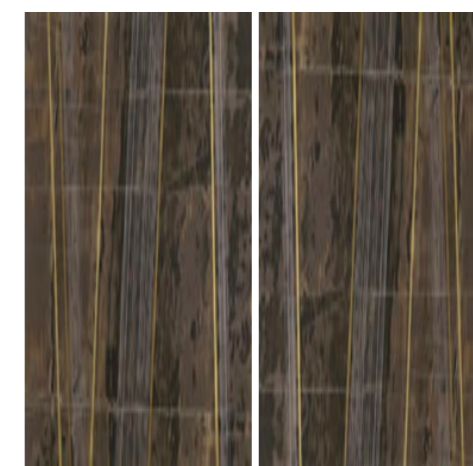

40x80 BROWN ONIX
57826

DECORO ROMBI (composizione 2 pz.)

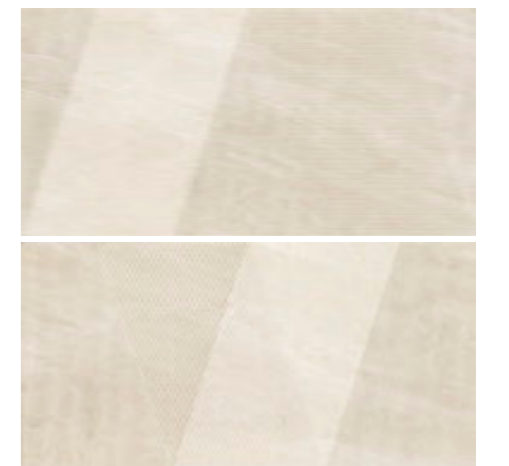

40x80 PEARL
57770

- 57821 STATUARIO
- 57824 CALACATTA
- 57822 CREAM
- 57827 INFINITY BLACK

- 57771 STATUARIO
- 57772 CREAM
- 57774 CALACATTA

DECORO ORGANIC



80x180 BROWN ONIX / GOLD
57830



80x180 INFINITY BLACK / GOLD
57831

FASCIA QUADRETTI

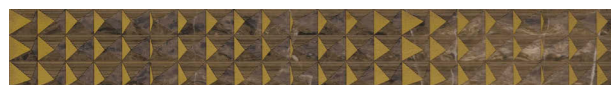

10x80 BROWN ONIX
57760



10x80 INFINITY BLACK
57761

MOSAICO FLOREALE (composizione 2 pz.)



40x40 WHITE
57790



40x40 CREAM
57791



40x40 BROWN
57792



40x40 BLACK
57793

ANGOLARE



40x40 WHITE
57780

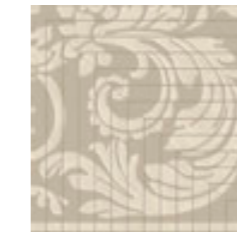

40x40 CREAM
57781

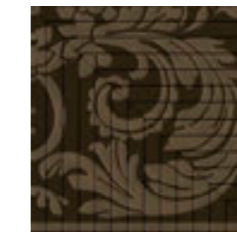

40x40 BROWN
57782



40x40 BLACK
57783

CASSETTONE



40x40 WHITE
57810



40x40 CREAM
57811

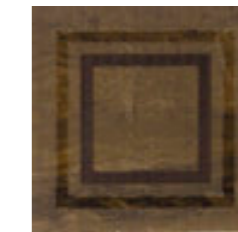

40x40 BROWN
57812

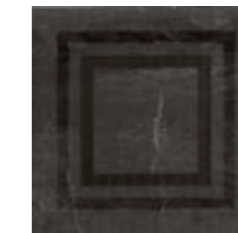

40x40 BLACK
57813

MOSAICO T196



40x40 WHITE
57800

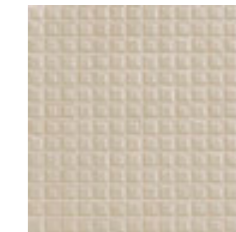

40x40 CREAM
57801

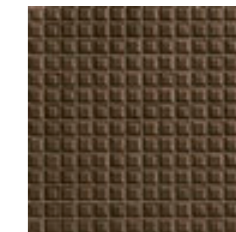

40x40 BROWN
57802

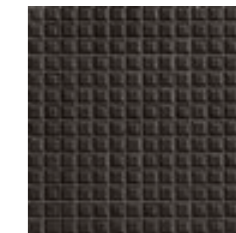

40x40 BLACK
57803

MOSAICO ROMBI



45,1x49,5 CALDO
57692

45,1x49,5 FREDDO
57693

Unique

MOSAICI E PEZZI SPECIALI

SPECIAL TRIMS . PIECES SPECIALES . SONDERSTÜCKE
PIEZAS ESPECIALES . СПЕЦИАЛЬНЫЕ ИЗДЕЛИЯ . 特别装饰

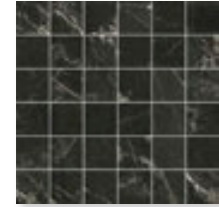

MOSAICO T36 33,3x33,3
1.



GRADONE 80x32x4
2.

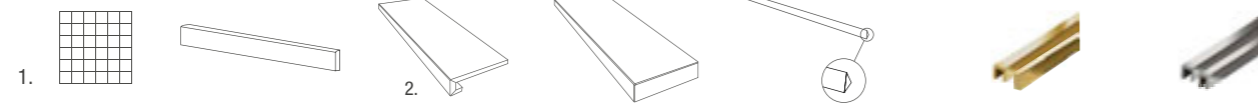

	MOSAICO T36 33,3X33,3	BATTISCOPA 8x80	GRADONE 80x32x4	GRADONE ANGOLARE 80x32x4	COPRISPIGOLO 1,2x80	PROFILI OTTONE M	PROFILI ACCIAIO M	
	PEARL	57710	ML57650	57720	57730 DX 57740 SX	57840	119863 1x80 26231 1x60	119862 1x80 26230 1x60
	STATUARIO VENATO	57711	ML57651	57721	57731 DX 57741 SX	57841	119861 0,5x80 26236 0,5x60	119860 0,5x80 26235 0,5x60
	CREAM	57712	ML57652	57722	57732 DX 57742 SX	57842		
	CALACATTA	57714	ML57654	57724	57734 DX 57744 SX	57844		
	BROWN ONYX	57716	ML57656	57726	57736 DX 57746 SX	57846		
	INFINITY BLACK	57717	ML57657	57727	57737 DX 57747 SX	57847		

IMBALLI . PACKING . CONDITIONNEMENT . VERPACKUNGSEINHEITEN . EMBALAJES . УПАКОВКА . 包裝

EN 14411/G Bla

FORMATO SIZE	SPESSORE THICKNESS	PZ/SCAT. PCS/BOX	MQ/SCAT. SQM/BOXT	KG/SCAT. KG/BOX	SCAT./PAL BOX/PAL	MQ/PAL SQM/PAL	KG/PAL
80x180 LAP	10 mm	2	2,880	64,44	18	51,84	1159,92
80x80 LAP	10 mm	2	1,280	28,00	40	51,20	1120,00
80x80 SOFT MATT	10 mm	2	1,280	28,00	35	44,80	980,00
40x80	10 mm	3	0,960	19,96	27	25,92	539,13
DECORO ORGANIC 80x180	10 mm	1	1,440	34,40	-	-	-
CASSETTONE 80x80	10 mm	2	1,280	28,00	40	51,20	1120,00
DECORO CASSETTONE 40x40	10 mm	4	0,640	14,00	-	-	-
DECORO LINEE 40x80 (comp. 2 pz.)	10 mm	2	0,640	15,30	-	-	-
DECORO ROMBI 40x80 (comp. 2 pz.)	10 mm	2	0,640	15,30	-	-	-
ANGOLRE 40x40	10 mm	4	0,640	14,00	-	-	-
FASCIA QUADRETTI 10x80	10 mm	4	3,20 ml	18,75	-	-	-
MOSAICI 40x40	10 mm	4	0,640	14,00	-	-	-
MOSAICO ROMBI 45,1x49,5	10 mm	2	0,446	14,00	-	-	-
MOSAICO T36 33,3x33,3	10 mm	4	0,443	9,60	-	-	-
BATTISCOPA 8x80	10 mm	10	8,00 ml	15,00	-	-	-
GRADONE 80x32x4	10 mm	2	1,60 ml	14,00	-	-	-
GRADONE ANGOLARE 80x32x4	10 mm	1	-	7,00	-	-	-
COPRISPIGOLO 1,2x80	-	6	4,80 ml	1,20	-	-	-
PROFILI METALLO 0,5x60 - 1x60	-	6	3,60 ml	2,70	-	-	-
PROFILI METALLO 0,5x80 - 1x80	-	6	4,80 ml	3,00	-	-	-

I DATI RELATIVI A IMBALLAGGI E PESI POSSONO SUBIRE DELLE VARIAZIONI . INFORMATIONS AND DETAILS RELATED TO PACKAGING AND WEIGHT ARE SUBJECT TO CHANGE
LES DONNÉES CONCERNANT EMBALLAGE ET POIDS SONT SUJETTES À VARIATIONS . DIE ANGABEN ÜBER VERPACKUNGEN UND GEWICHTE SIND NICHT BINDEND
LOS DATOS RELACIONADOS CON EL EMBALAJE Y LOS PESOS PUEDEN ESTAR SUJETOS A CAMBIOS . ДАННЫЕ, ОТНОСЯЩИЕСЯ К УПАКОВКЕ И ВЕСУ, ПОДЛЕЖАТ ИЗМЕНЕНИЯМ
与包装和重量有关的数据可能会更改



FLOOR: STATUARIO 80x180 - INFINITY BLACK 40x80 - MOSAICO FLOREALE 40x40
WALL: STATUARIO 40x80 - INFINITY BLACK 80x80
MOSAICO FLOREALE WHITE / BLACK 40x40 - MOSAICO T196 BLACK 40x40



i Cementi

pragetti

- 96 D.Sign
- 106 Make
- 120 Mood
- 134 Native
- 144 Walk





FLOOR: ANTRACITE 80x80 - SAND 100x100 - DECORO FILIGRANA GREY 60x60
 WALL: ANTRACITE 80x80 - SAND 100x100 - WALL 3D RETTANGOLO SALMONE 40x40

i Cementi

D.Sign

GRES FINE PORCELLANATO AD IMPASTO COLORATO

COLORBODY FINE PORCELAIN STONEWARE
 GRES CÉRAMÉ TEINTÉ DANS LA MASSE
 FEINSGEINZEUG MIT EINGEFÄRBTEN SCHERBEN
 GRES PORCELÁNICO MASA COLOREADA
 ОКРАШЕННЫЙ ПО ВСЕ ТОЛЩИНЕ КЕРАМОГРАНИТ
 彩色坯体瓷质玻化上釉砖



TECNOLOGIA AD ALTA DEFINIZIONE
HIGH-DEFINITION TECHNOLOGY



DECORAZIONE DIGITALE A SECCO
DIGITAL DRY DECORATION

MOSAICI E DECORI



2 SUPERFICI (NATURALI)

NATURAL SURFACES
 SURFACES NATURELLES
 NATÜRLICHE OBERFLÄCHEN
 SUPERFICIES NATURALES
 НАТУРАЛЬНАЯ ПОВЕРХНОСТЬ
 天然表面



R10-R11

R10 GRUPPO B (INDOOR)
 DCOF > 0,42
 ASTM C1028 > 0,60
 BCRA W.D. > 0,40
 PTV FOUR 6 W.D. > 0,36

R11 GRUPPO B (OUTDOOR)
 DCOF > 0,42
 ASTM C1028 > 0,60
 BCRA W.D. > 0,40
 PTV FOUR 6 W.D. > 0,36



100x100
40"x40"

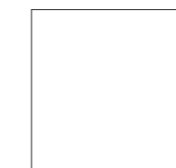

80x80
32"x32"

80x80
32"x32"



40x80
16"x32"

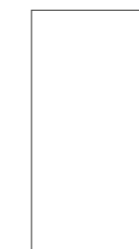

60x120
24"x48"



30x60
12"x24"

60x60
24"x24"



WHITE V3



SAND V3



GREY V3



ANTRACITE V3



FLOOR: WHITE 100x100 - GREY 60x60
WALL: DECORO FILIGRANA GREY 60x120
DECORO TEXTURE WHITE 20x120



WHITE

SAND

GREY

ANTRACITE

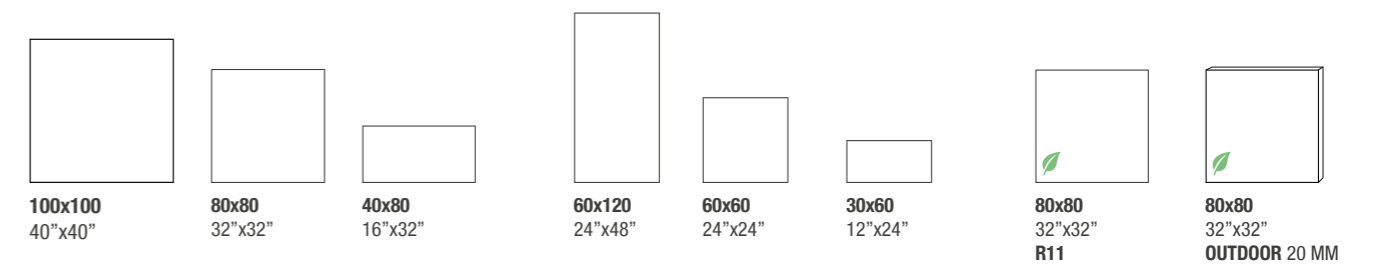
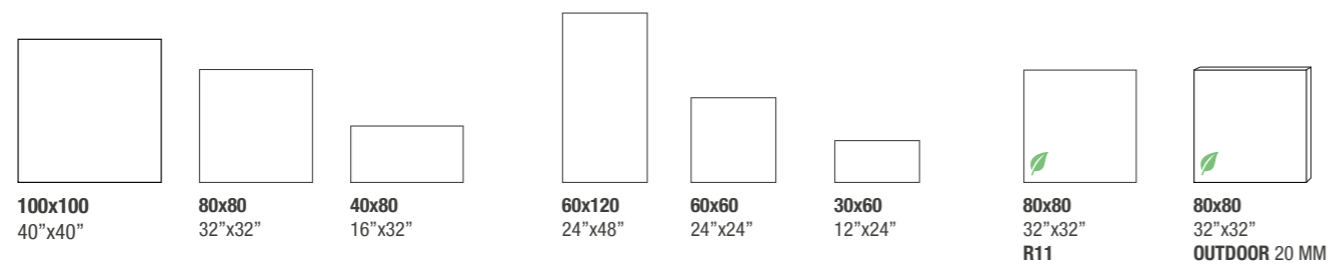

WHITE	74000	74020	74030	74040	74050	74270	74090	74100
SAND	74001	74021	74031	74041	74051	74271	74091	74101

GREY	74002	74022	74032	74042	74052	74272	74092	74102
ANTRACITE	74003	74023	74033	74043	74053	74273	74093	74103

DECORO RIVESTIMENTO TEXTURE 20x120 (mix 3 soggetti)



20x120
WALL DEK WHITE
74080

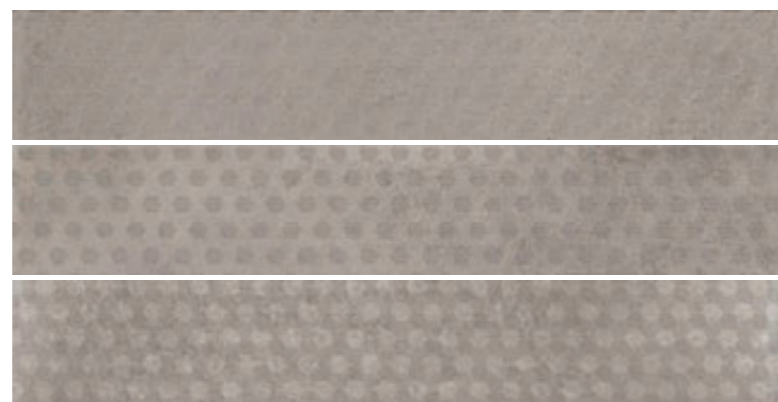

20x120
WALL DEK SAND
74081



20x120
WALL DEK GREY
74082



20x120
WALL DEK ANTRACITE
74083

DECORO FILIGRANA



60x120 DECORO CEMENTO GREY
74112

MOSAICI E PEZZI SPECIALI

SPECIAL TRIMS , PIÈCES SPECIALES , SONDERSTÜCKE
PIEZAS ESPECIALES , СПЕЦИАЛЬНЫЕ ИЗДЕЛИЯ , 特别装饰

	MOSAICO T36 30x30	MOSAICO ESAGONI MIX 23,5x29,7	BATTISCOPA MOLATO			GRADONE 120x32x4	GRADONE ANGOLARE 120x32x4	PROFILI IN FERRO	PROFILI ACCIAIO
			8x60	8x80	8x100				
WHITE	74120	-	ML74050	ML74020	ML74003	74150	74170 SX 74160DX	73601 2x100 73600 1x100	119862 1x80 26230 1x60
SAND	74121	74130	ML74051	ML74021	ML74002	74151	74171 SX 74161 DX	119860 0,5x80 26235 0,5x60	119860 0,5x80 26235 0,5x60
GREY	74122	-	ML74052	ML74022	ML74000	74152	74172 SX 74162 DX		
ANTRACITE	74123	-	ML74053	ML74023	ML74001	74153	74173 SX 74163 DX		

	ELEMENTO AD "L" 80x32x4 OUTDOOR 9 MM	ELEMENTO AD "L" 80x32x4 OUTDOOR 20 MM	ELEMENTO AD "L" 100x32x4 OUTDOOR 20 MM	GRADONE BORDO ARROTONDATO 80X40 OUTDOOR 20 MM	GRADONE BECCO CIVETTA 80X40 OUTDOOR 20 MM	ANGOLARE BORDO ARROTONDATO (KIT DX/SX) 160X40 OUTDOOR 20 MM	ANGOLARE BECCO CIVETTA (KIT DX/SX) 160X40 OUTDOOR 20 MM
WHITE	74180	74190	74260	74210	74220	74230	74240
SAND	74181	74191	74261	74211	74221	74231	74241
GREY	74182	74192	-	74212	74222	74232	74242
ANTRACITE	74183	74193	-	74213	74223	74233	74243

D.Sign

IMBALLI . PACKING . CONDITIONNEMENT . VERPACKUNGSEINHEITEN . EMBALAJES . УПАКОВКА . 包裝

EN 14411/G Bla

FORMATO SIZE	SPESSORE THICKNESS	PZ/SCAT. PCS/BOX	MQ/SCAT. SQM/BOXT	KG/SCAT. KG/BOX	SCAT./PAL BOX/PAL	MQ/PAL SQM/PAL	KG/PAL
100x100	9 mm	2	2,000	39,60	24	48,00	950,00
80x80	9 mm	2	1,280	24,50	40	51,20	980,00
40x80	9 mm	4	1,280	25,20	27	34,56	690,61
60x120	9 mm	2	1,440	29,52	26	37,44	767,52
60x60	9 mm	3	1,080	21,25	40	43,20	850,00
30x60	9 mm	7	1,260	24,62	40	50,40	985,00
DECORO 60x120	9 mm	2	1,440	29,52	-	-	-
MOSAICO 30x30	9 mm	4	0,360	8,50	-	-	-
BATTISCOPA 8x100	9 mm	4	4,00 ml	7,36	-	-	-
BATTISCOPA 8x80	9 mm	10	8,00 ml	12,00	-	-	-
BATTISCOPA 8x60	9 mm	10	6,00 ml	10,00	-	-	-
GRADONE 120x32x4	9 mm	2	2,40 ml	22,85	-	-	-
GRADONE ANGOLARE 120x32x4	9 mm	1	-	11,42	-	-	-
ELEMENTO L 80x32x4	9 mm	2	1,60 ml	14,00	-	-	-
ELEMENTO L 100x32x4	9 mm	2	2,00 ml	17,50	-	-	-
80x80 OUTDOOR	20 mm	1	0,640	28,75	45	44,92	1293,75
ELEMENTO L 80X32X4 OUTDOOR	20 mm	2	1,60 ml	20,00	-	-	-
GRADONE BORDO ARROTONDATO 80X40 OUTDOOR	20 mm	2	1,60 ml	29,00	-	-	-
GRADONE BECCO DI CIVETTA 80X40 OUTDOOR	20 mm	2	1,60 ml	29,00	-	-	-
ANGOLARE BORDO ARROTONDATO 80X40 OUTDOOR	20 mm	1	-	25,00	-	-	-
ANGOLARE BECCO DI CIVETTA 80X40 OUTDOOR	20 mm	1	-	25,00	-	-	-
PROFILI METALLO 0,5x60 - 1x60	-	6	3,60 ml	2,70	-	-	-
PROFILI METALLO 0,5x80 - 1x80	-	6	4,80 ml	3,00	-	-	-

I DATI RELATIVI A IMBALLAGGI E PESI POSSONO SUBIRE DELLE VARIAZIONI . INFORMATIONS AND DETAILS RELATED TO PACKAGING AND WEIGHT ARE SUBJECT TO CHANGE
 LES DONNÉES CONCERNANT EMBALLAGE ET POIDS SONT SUJETTES À VARIATIONS . DIE ANGABEN ÜBER VERPACKUNGEN UND GEWICHTE SIND NICHT BINDEND
 LOS DATOS RELACIONADOS CON EL EMBALAJE Y LOS PESOS PUEDEN ESTAR SUJETOS A CAMBIOS . ДАННЫЕ, ОТНОСЯЩИЕСЯ К УПАКОВКЕ И ВЕСУ, ПОДЛЕЖАТ ИЗМЕНЕНИЯМ
 与包装和重量有关的数据可能会更改



FLOOR: GREY 80X80
 WALL: ANTRACITE 120X120

i Cementi

Make

GRES FINE PORCELLANATO AD IMPASTO COLORATO

COLORBODY FINE PORCELAIN STONEWARE
GRES CÉRAME TEINTÉ DANS LA MASSE
FEINSGEINZEUG MIT EINGEFÄRBTEN SCHERBEN
GRES PORCELÁNICO MASA COLOREADA
ОКРАШЕННЫЙ ПО ВСЕ ТОЛЩИНЕ КЕРАМОГРАНИТ
彩色坯体瓷质玻化上釉砖



TECNOLOGIA AD ALTA DEFINIZIONE
HIGH-DEFINITION TECHNOLOGY

MOSAICI E DECORI



2 SUPERFICI (NATURALI)

NATURAL SURFACES
SURFACES NATURELLES
NATÜRLICHE OBERFLÄCHEN
SUPERFICIES NATURALES
НАТУРАЛЬНАЯ ПОВЕРХНОСТЬ
天然表面



R10-R11

R10 GRUPPO B (INDOOR)
DCOF > 0,42
ASTM C1028 > 0,60
BCRA W.D. > 0,40
PTV FOUR 6 W.D. > 0,36

R11 GRUPPO B (OUTDOOR)
DCOF > 0,42
ASTM C1028 > 0,60
BCRA W.D. > 0,40
PTV FOUR 6 W.D. > 0,36



100x100
40"x40"

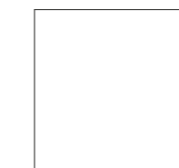

80x80
32"x32"

80x80 32"x32"



40x80
16"x32"



60x120
24"x48"



30x60
12"x24"

60x60
24"x24"

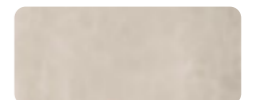

CORDA V3

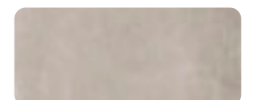

ASH V3



BIANCO V3

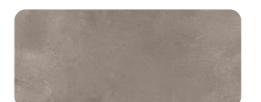

GRIGIO CORTEN V3



ANTRACITE CORTEN V4



NERO CORTEN V4



Make



FLOOR: Antracite Corten 80x80
WALL: Antracite Corten 40x80



FLOOR: ANTRACITE CORTEN 80x80
WALL: ANTRACITE CORTEN 80x80 - ANTRACITE CORTEN 40x80

Make



FLOOR: BIANCO 80x80



WALL: GRIGIO CORTEN 40x80 - CEMENTINE MIX CORTEN 20x20 - BIANCO 40x80
FLOOR: BIANCO 80x80



ASH



GRIGIO CORTEN

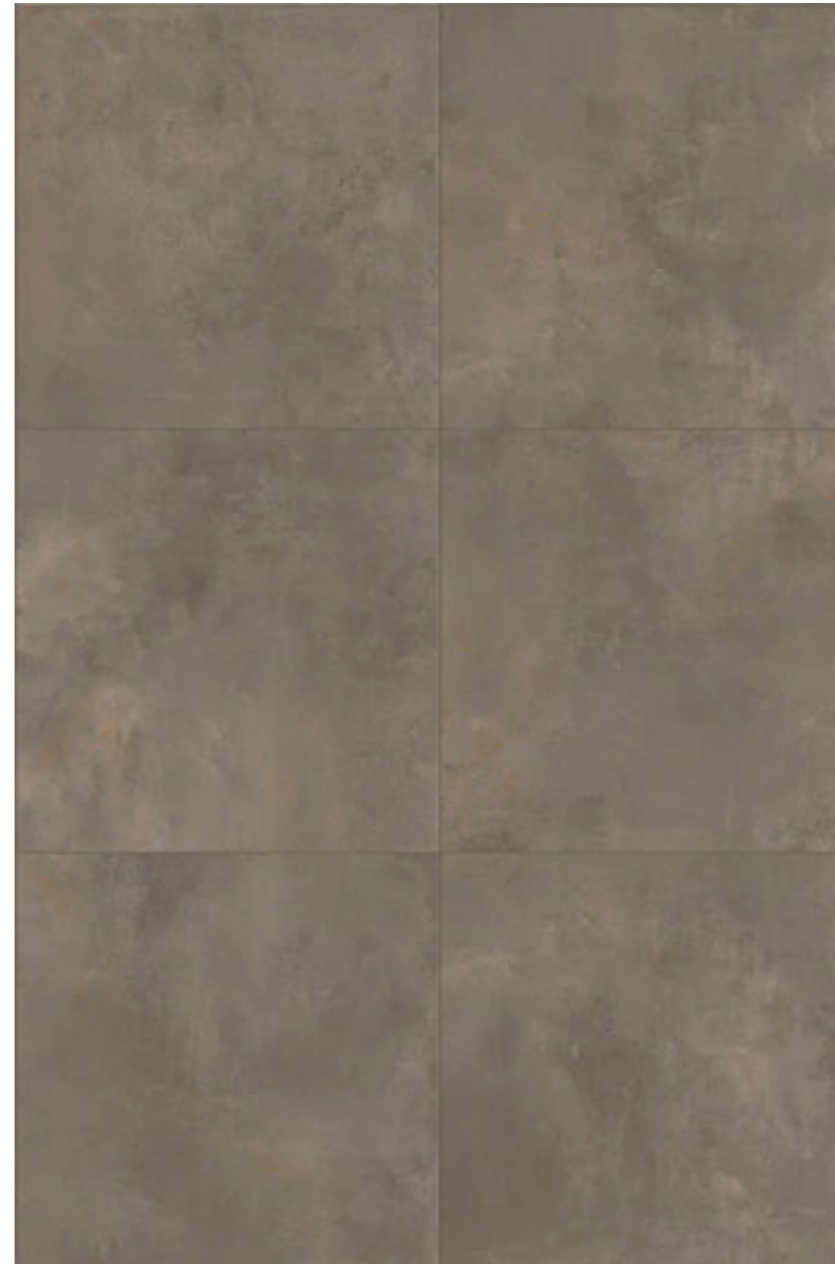

ANTRACITE CORTEN



NERO CORTEN

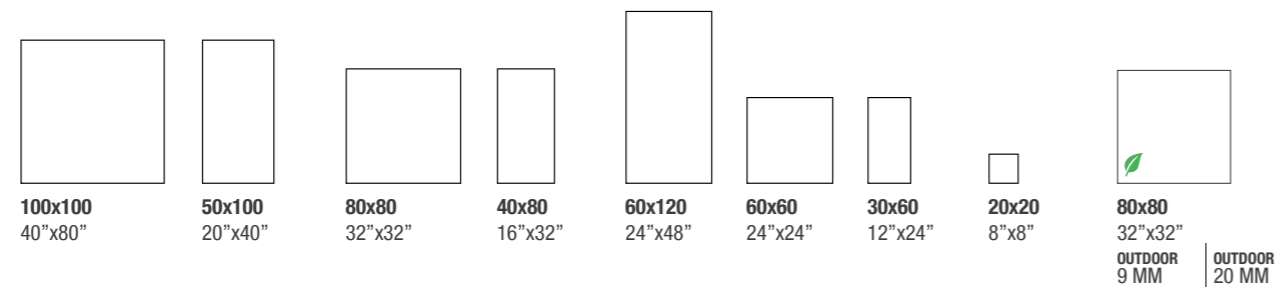

ASH	73042	73032	73022	73012	73222	73212	73202	73282	73102	73052
GRIGIO CORTEN	73045	73035	73025	73015	73225	73215	73205	73285	73105	73055

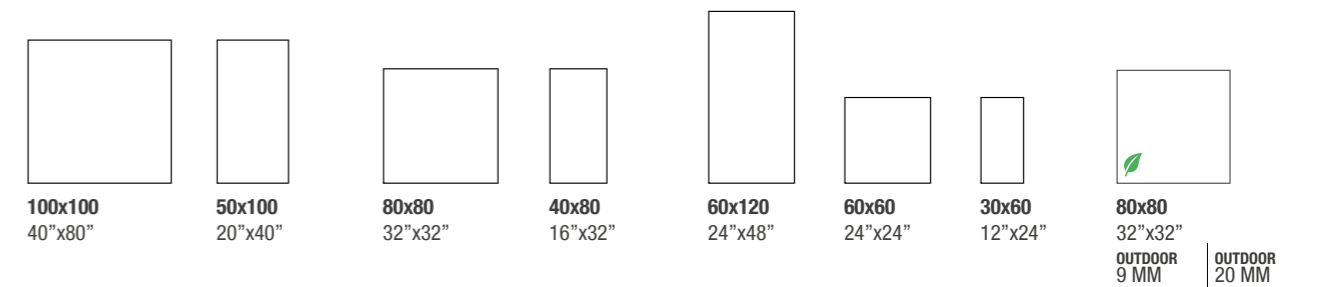

ANTRACITE CORTEN	73044	73034	73024	73014	73224	73214	73204	73104	73054
NERO CORTEN	73043	73033	73023	73013	73223	73213	73203	-	73053



BIANCO

CORDA

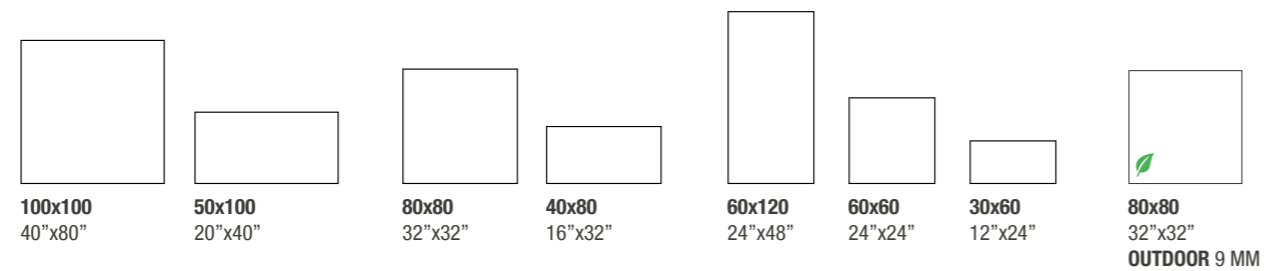

BIANCO	73040	73030	73020	73010	73220	73210	73200	-
CORDA	73041	73031	73021	73011	73221	73211	73201	73101

CEMENTINE MIX



20x20 CEMENTINE MIX
73000



20x20 CEMENTINE MIX CORTEN
73001

MOSAICI E PEZZI SPECIALI











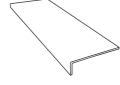
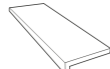
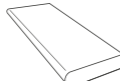

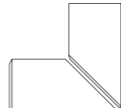
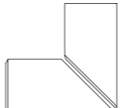

SPECIAL TRIMS . PIECES SPECIALES . SONDERSTÜCKE
PIEZAS ESPECIALES . СПЕЦИАЛЬНЫЕ ИЗДЕЛИЯ . 特别装饰

	MOSAICO T36 33,3x33,3	MOSAICO ESAGONI MIX 23,5x29,7	BATTISCOPA MOLATO			GRADONE 120x32x4	GRADONE ANGOLARE 120x32x4	PROFILI IN FERRO	PROFILI ACCIAIO
			8x60	8x80	8x100			M	M
BIANCO	73250	73260	ML73210	ML73020	ML73040	73110	73120 SX 73130 DX	73601 2x100 73600 1x100	119862 1x80 26230 1x60
CORDA	73251	-	ML73211	ML73021	ML73041	73111	73121 SX 73131 DX	119860 0,5x80 26235 0,5x60	119860 0,5x80 26235 0,5x60
ASH	73252	-	ML73212	ML73022	ML73042	73112	73122 SX 73132 DX		
NERO CORTEN	73253	-	ML73213	ML73023	ML73043	73113	73123 SX 73133 DX		
ANTRACITE CORTEN	73254	-	ML73214	ML73024	ML73044	73114	73124 SX 73134 DX		
GRIGIO CORTEN	73255	-	ML73215	ML73025	ML73045	73115	73125 SX 73135 DX		

Make

MOSAICI E PEZZI SPECIALI

SPECIAL TRIMS . PIECES SPECIALES . SONDERSTÜCKE
PIEZAS ESPECIALES . СПЕЦИАЛЬНЫЕ ИЗДЕЛИЯ . 特别装饰

						
	ELEMENTO AD "L" 80x32x4 OUTDOOR 9 MM 	ELEMENTO AD "L" 80x32x4 OUTDOOR 20 MM 	GRADONE ARROTONDATO 80X40 OUTDOOR 20 MM 	GRADONE BECCO CIVETTA 80X40 OUTDOOR 20 MM 	ANGOLARE BORDO ARROTONDATO (KIT DX/SX) 160X40 OUTDOOR 20 MM 	ANGOLARE BECCO CIVETTA (KIT DX/SX) 160X40 OUTDOOR 20 MM 
 CORDA	73141	-	-	-	-	-
 ASH	73142	73232	73222	73332	73342	73352
 NERO CORTEN	-	73233	73223	73333	73343	73353
 ANTRACITE CORTEN	73144	73234	73224	73334	73344	73354
 GRIGIO CORTEN	73145	73235	73225	73335	73345	73355

IMBALLI . PACKING . CONDITIONNEMENT . VERPACKUNGSEINHEITEN . EMBALAJES . УПАКОВКА . 包裝

EN 14411/UGL Bla

FORMATO SIZE	SPESSORE THICKNESS	PZ/SCAT. PCS/BOX	MQ/SCAT. SQM/BOXT	KG/SCAT. KG/BOX	SCAT./PAL BOX/PAL	MQ/PAL SQM/PAL	KG/PAL
100x100	9 mm	2	2,000	38,50	24	48,00	924,00
50x100	9 mm	4	2,000	38,50	24	48,00	924,00
80x80	9 mm	2	1,280	24,50	40	51,20	980,00
40x80	9 mm	4	1,280	25,20	27	34,56	680,61
60x120	9 mm	2	1,440	29,52	26	37,44	767,52
60x60	9 mm	3	1,080	21,25	40	43,20	850,00
30x60	9 mm	7	1,260	22,46	40	50,40	898,56
20x20	9 mm	25	1,000	19,80	42	42,00	831,60
CEMENTINE MIX 20x20	9 mm	25	1,000	19,80	42	42,00	831,60
MOSAICO T36 33,3x33,3	9 mm	4	0,443	9,60	-	-	-
MOSAICO ESAGONI mix 23,5x29,7	9 mm	4	-	9,00	-	-	-
BATTISCOPA 8x60	9 mm	10	6,00 ml	18,40	-	-	-
BATTISCOPA 8x80	9 mm	10	8,00 ml	12,00	-	-	-
BATTISCOPA 8x100	9 mm	4	4,00 ml	7,36	-	-	-
ELEMENTO AD "L" 80x32x4 OUTDOOR	9 mm	2	1,60 ml	14,00	-	-	-
GRADONE 120x32x4	9 mm	2	2,40 ml	22,85	-	-	-
ANGOLARE GRADONE 120x32x4	9 mm	1	-	11,42	-	-	-
80x80	20 mm	1	0,640	28,75	45	28,80	1293,75
ELEMENTO AD "L" 80x32x4 - OUTDOOR	20 mm	2	1,60 ml	14,00	-	-	-
GRADONE TORELLO 80x32 - OUTDOOR	20 mm	2	-	14,00	-	-	-
GRADONE BORDO ARROTONDATO 80X40 OUTDOOR	20 mm	2	1,60 ml	29,00	-	-	-
GRADONE BECCO DI CIVETTA 80X40 OUTDOOR	20 mm	2	1,60 ml	29,00	-	-	-
ANGOLARE BORDO ARROTONDATO 80X40 OUTDOOR	20 mm	1	-	25,00	-	-	-
ANGOLARE BECCO DI CIVETTA 80X40 OUTDOOR	20 mm	1	-	25,00	-	-	-
PROFILO FERRO 1x100 / 2x100	-	4	4,00 ml	1,40	-	-	-
PROFILO ACCIAIO 1x100 / 2x100	-	6	-	-	-	-	-

I DATI RELATIVI A IMBALLAGGI E PESI POSSONO SUBIRE DELLE VARIAZIONI . INFORMATIONS AND DETAILS RELATED TO PACKAGING AND WEIGHT ARE SUBJECT TO CHANGE
LES DONNÉES CONCERNANT EMBALLAGE ET POIDS SONT SUJETTES À VARIATIONS . DIE ANGABEN ÜBER VERPACKUNGEN UND GEWICHTE SIND NICHT BINDEND
LOS DATOS RELACIONADOS CON EL EMBALAJE Y LOS PESOS PUEDEN ESTAR SUJETOS A CAMBIOS . ДАННЫЕ, ОТНОСЯЩИЕСЯ К УПАКОВКЕ И ВЕСУ, ПОДЛЕЖАТ ИЗМЕНЕНИЯМ
与包装和重量有关的数据可能会更改



FLOOR: ASH 80x80



CANVAS 80x80 - RUST 80x80

i Cementi

Mood

GRES FINE PORCELLANATO AD IMPASTO COLORATO

COLORBODY FINE PORCELAIN STONEWARE

GRES CÉRAME TEINTÉ DANS LA MASSE

FEINSGEINZEUG MIT EINGEFÄRBTEN SCHERBEN

GRES PORCELÁNICO MASA COLOREADA

ОКРАШЕННЫЙ ПО ВСЕ ТОЛЩИНЕ КЕРАМОГРАНИТ

彩色坯体瓷质玻化上釉砖



TECNOLOGIA AD ALTA DEFINIZIONE
HIGH-DEFINITION TECHNOLOGY

MOSAICI E DECORI



2 SUPERFICI (NATURALE E OUTDOOR)

NATURAL SURFACE

SURFACE NATURELLE

NATÜRLICHE OBERFLÄCHE

SUPERFICIE NATURAL

НАТУРАЛЬНАЯ ПОВЕРХНОСТЬ

天然表面



R10-R11

R10 GRUPPO B (INDOOR)

DCOF > 0,42

ASTM C1028 > 0,60

BCRA W.D. > 0,40

R11 GRUPPO B (OUTDOOR)

DCOF > 0,42

ASTM C1028 > 0,60

BCRA W.D. > 0,40

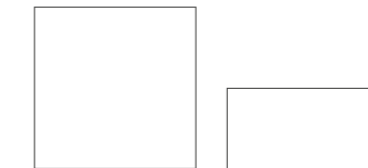

80x80
32"x32"

80x80
32"x32"

40x80
16"x32"



SALT

V2



CLAY

V2

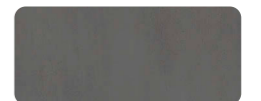

ASH

V2



CANVAS

V2



TAN

V2



RUST

V2





WALL: SALT 80x80
FLOOR: CLAY 80x80 - CERCHI 3D 40x40 MARSALA



FLOOR: CLAY 80x80
WALL: ASH 80x80 - SALT 80x80 - CERCHI 3D CELESTE 40x40

Mood



FLOOR: Rust 40x80 - Canvas 80x80
WALL: Rust 80x80



SALT



CLAY

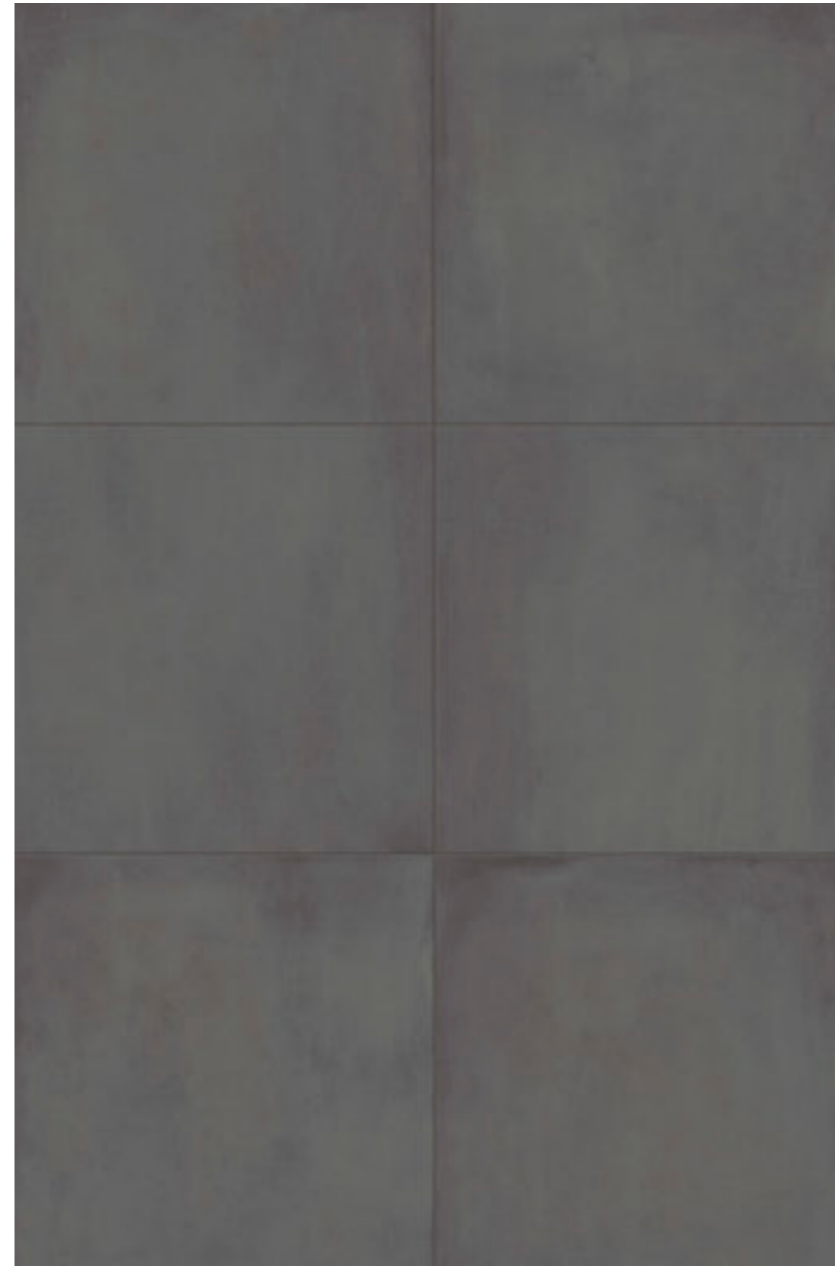

ASH



RUST



80x80
32"x32"



40x80
16"x32"



80x80
32"x32"
OUTDOOR 9 MM





80x80
32"x32"





40x80
16"x32"



80x80
32"x32"
OUTDOOR 9 MM

	SALT	54810	54800	54890
	CLAY	54813	54803	54893

	ASH	54815	54805	54895
	RUST	54814	54804	54894

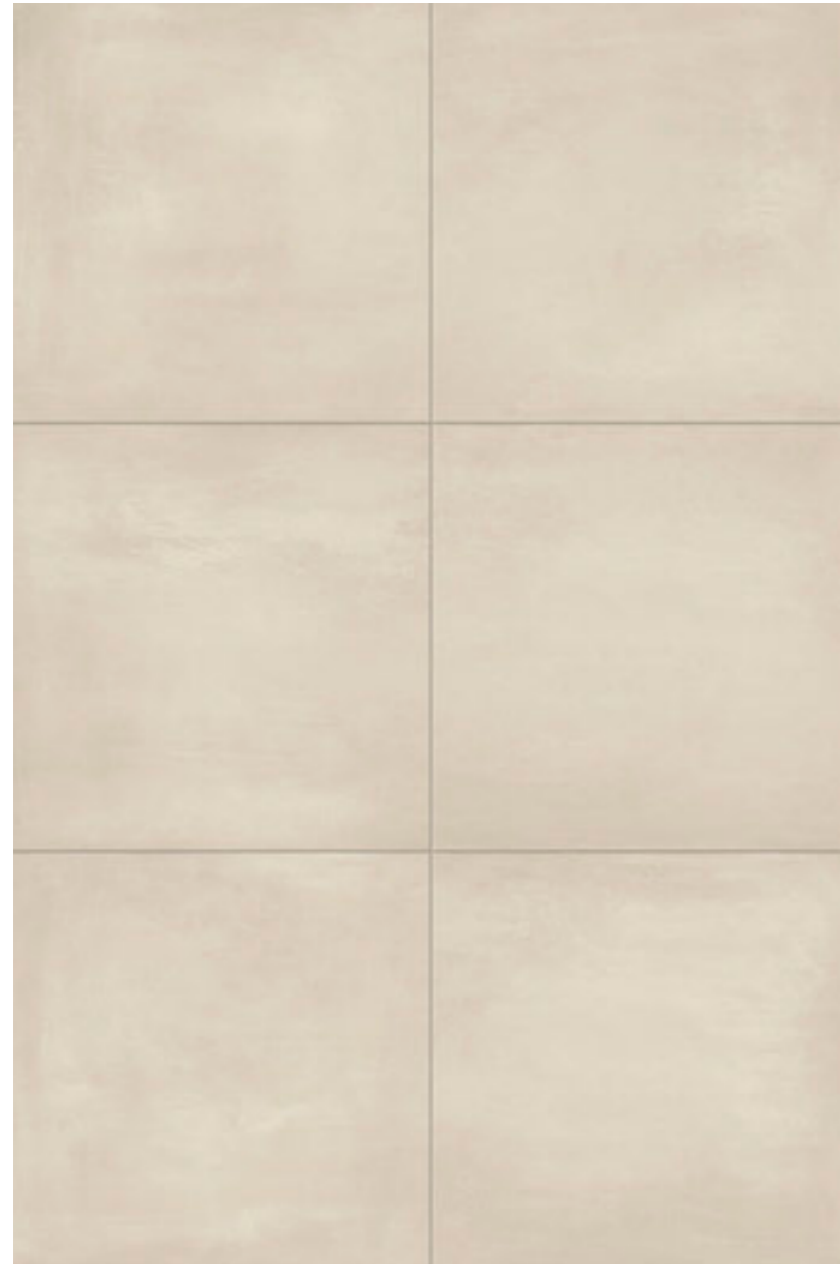

CANVAS

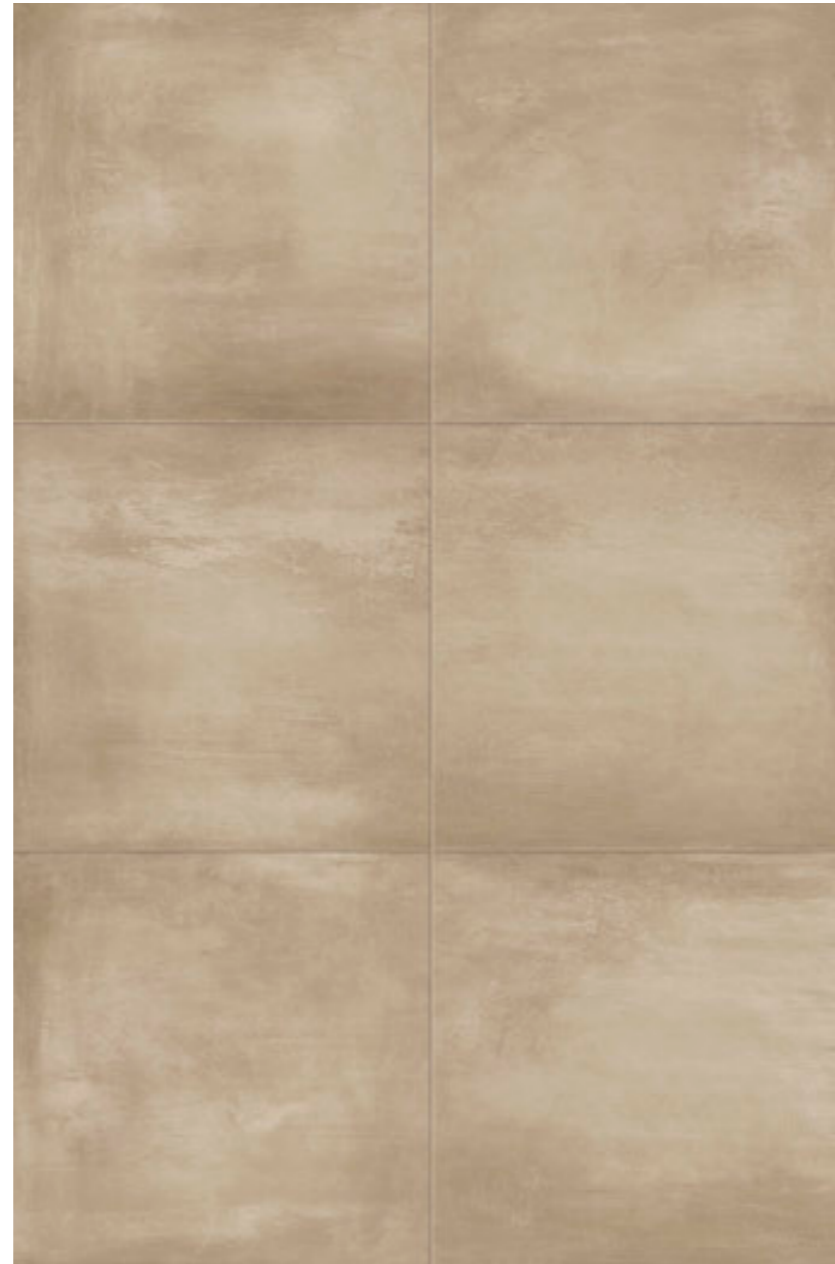

TAN





80x80
32"x32"



40x80
16"x32"



80x80
32"x32"
OUTDOOR 9 MM

	CANVAS	54811	54801	54891
	TAN	54812	54802	54892



CERCHI 3D



40x40 AVORIO
65483

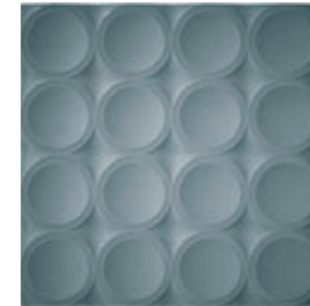

40x40 CELESTE
65482

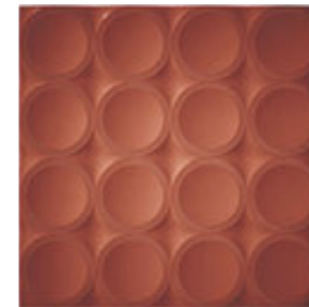

40x40 MARSALA
65480

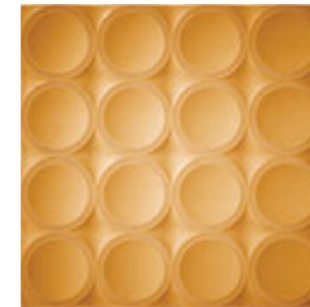

40x40 SENAPE
65481

MOSAICO ESAGONI T9



40x35 CALDO
55141



40x35 FREDDO
55140



WALL: mosaico esagoni mix freddo T9 40x35

Mood

MOSAICI E PEZZI SPECIALI

SPECIAL TRIMS . PIÈCES SPECIALES . SONDERSTÜCKE
PIEZAS ESPECIALES . СПЕЦИАЛЬНЫЕ ИЗДЕЛИЯ . 特别装饰

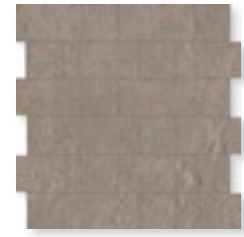

MOSAICO MURETTO T24 33,3x33,3
1.



MOSAICO T36 33,3x33,3
2.



MOSAICO ESAGONI T9 40x35
3.



GRADONE 80x32x4
4.

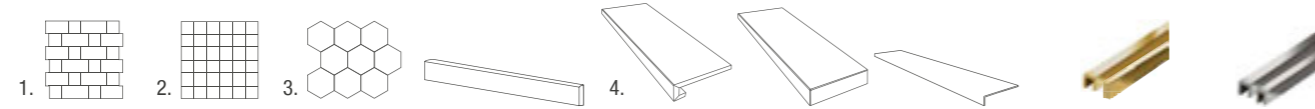

	MOSAICO MURETTO T24 33,3x33,3	MOSAICO T36 33,3x33,3	MOSAICO ESAGONI T9 40x35	BATTISCOPA MOLATO	GRADONE 80x32x4	GRADONE ANGOLARE 80x32x4	ELEMENTO "L" 80x32x4 OUTDOOR	PROFILI OTTONE	PROFILI ACCIAIO	
	SALT	55190	55120	55130	ML54810 8x80	55150	55160 DX 55170 SX	55180	119863 1x80 26231 1x60	119862 1x80 26230 1x60
	CLAY	55193	55123	55133	ML54813 8x80	55153	55163 DX 55173 SX	55183	119861 0,5x80 26236 0,5x60	119860 0,5x80 26235 0,5x60
	ASH	55195	55125	55135	ML54815 8x80	55155	55165 DX 55175 SX	55185		
	CANVAS	55191	55121	55131	ML54811 8x80	55151	55161 DX 55171 SX	55181		
	TAN	55192	55122	55132	ML54812 8x80	55152	55162 DX 55172 SX	55182		
	RUST	55194	55124	55134	ML54814 8x80	55154	55164 DX 55174 SX	55184		

IMBALLI . PACKING . CONDITIONNEMENT . VERPACKUNGSEINHEITEN . EMBALAJES . УПАКОВКА . 包装

EN 14411/G Bla

FORMATO SIZE	SPESSORE THICKNESS	PZ/SCAT. PCS/BOX	MQ/SCAT. SQM/BOXT	KG/SCAT. KG/BOX	SCAT./PAL BOX/PAL	MQ/PAL SQM/PAL	KG/PAL
80x80	9 mm	2	1,280	24,50	40	51,20	980,00
40x80	9 mm	4	1,280	25,20	27	34,56	680,40
MOSAICI 33,3x33,3	9 mm	4	-	9,60	-	-	-
MOSAICO ESAGONO T9 40x35	9 mm	4	-	15,00	-	-	-
BATTISCOPA MOLATO 8x80	9 mm	10	8,00 ml	12,00	-	-	-
GRADONE 80x32x4	9 mm	2	1,60 ml	14,00	-	-	-
GRADONE ANGOLARE 80x32x4	9 mm	1	-	7,00	-	-	-
ELEMENTO "L" 80x32x4	9 mm	2	1,60 ml	14,00	-	-	-
PROFILI METALLO 0,5x60 - 1x60	9 mm	6	3,60 ml	2,70	-	-	-
PROFILI METALLO 0,5x80 - 1x80	9 mm	6	4,80 ml	3,00	-	-	-
							EN 14411/K BIII GL
RIVESTIMENTO 40x40 (16"x16")	9 mm	6	0,960	18,00	48	46,08	864,00

I DATI RELATIVI A IMBALLAGGI E PESI POSSONO SUBIRE DELLE VARIAZIONI . INFORMATIONS AND DETAILS RELATED TO PACKAGING AND WEIGHT ARE SUBJECT TO CHANGE
LES DONNÉES CONCERNANT EMBALLAGE ET POIDS SONT SUJETTES À VARIATIONS . DIE ANGABEN ÜBER VERPACKUNGEN UND GEWICHTE SIND NICHT BINDEND
LOS DATOS RELACIONADOS CON EL EMBALAJE Y LOS PESOS PUEDEN ESTAR SUJETOS A CAMBIOS . ДАННЫЕ, ОТНОСЯЩИЕСЯ К УПАКОВКЕ И ВЕСУ, ПОДЛЕЖАТ ИЗМЕНЕНИЯМ
与包装和重量有关的数据可能会更改



WALL: mosaico muretto Rust 33,3x33,3



FLOOR: SAND TEXTURE 80x80

i Cementi

Native

GRES FINE PORCELLANATO AD IMPASTO COLORATO

COLORBODY FINE PORCELAIN STONEWARE
GRES CÉRAME TEINTÉ DANS LA MASSE
FEINSGEINZEUG MIT EINGEFÄRBTEN SCHERBEN
GRES PORCELÁNICO MASA COLOREADA
ОКРАШЕННЫЙ ПО ВСЕ ТОЛЩИНЕ КЕРАМОГРАНИТ
彩色坯体瓷质玻化上釉砖



TECNOLOGIA AD ALTA DEFINIZIONE
HIGH-DEFINITION TECHNOLOGY

MOSAICI E DECORI



2 SUPERFICI (NATURALI)

NATURAL SURFACES
SURFACES NATURELLES
NATÜRLICHE OBERFLÄCHEN
SUPERFICIES NATURALES
НАТУРАЛЬНАЯ ПОВЕРХНОСТЬ
天然表面



R10-R11

R10 GRUPPO B (INDOOR)
DCOF > 0,42
ASTM C1028 > 0,60
BCRA W.D. > 0,40

R11 GRUPPO B (OUTDOOR)
DCOF > 0,42
ASTM C1028 > 0,60
BCRA W.D. > 0,40

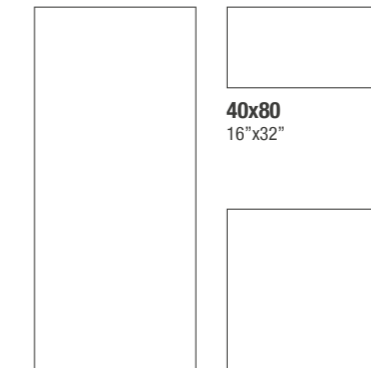

40x80
16"x32"

80x180
32"x72"

80x80
32"x32"

80x80
32"x32"



60x120
24"x48"



60x60
24"x24"



SAND V3



MUD V3



SILVER V3



CONCRETE V3



FLOOR: SAND 80x180
WALL: SAND 80x180
RECEPTION CONCRETE 80x180



WALL: SAND 40x80 / 80x80 - CONCRETE 40x80 / 80x80 - MUD 40x80 / 80x80
 FLOOR: SAND TEXTURE 80x80 - GRADONE MUD

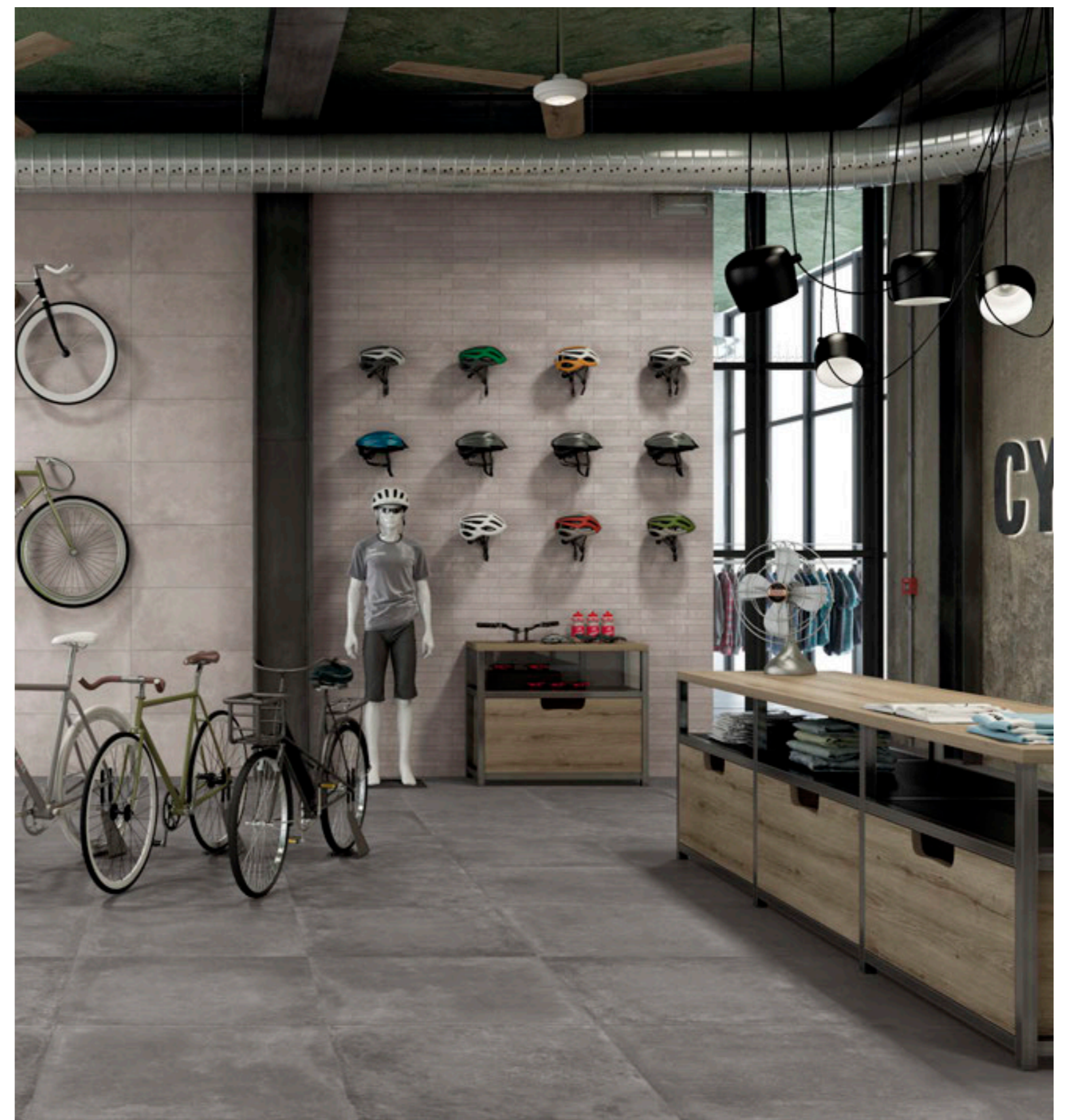

FLOOR: CONCRETE 80x80
 WALL: SILVER 40x80 - MOSAICO T6 SILVER 30x30



SAND

MUD

SILVER

CONCRETE

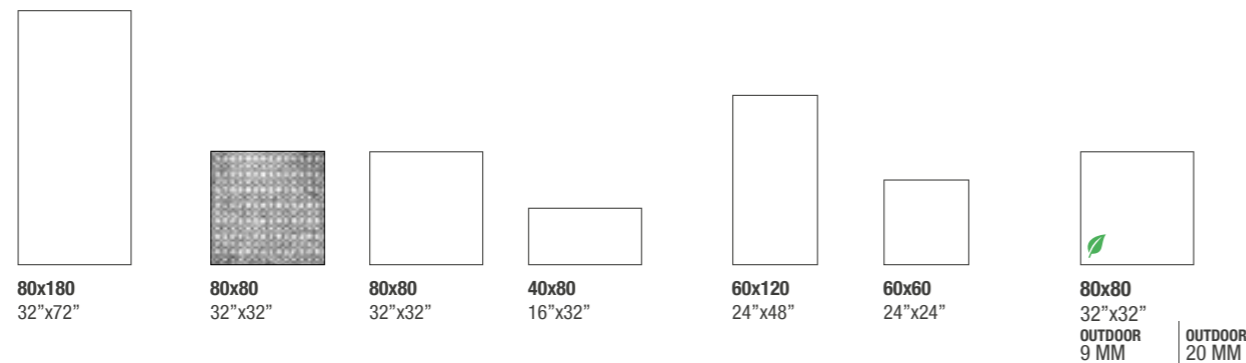

	SAND	56770	56720	56700	56710	56660	55650	56690	56790
	MUD	56772	56722	56702	56712	56662	55652	56692	56792

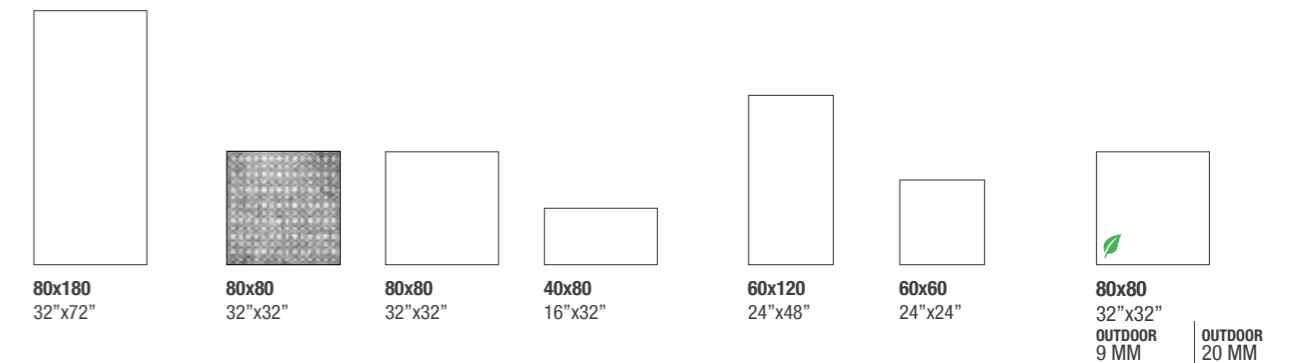

	SILVER	56771	56721	56701	56711	56661	55651	56691	56791
	CONCRETE	56773	56723	56703	56713	56663	55653	56693	56793

MOSAICI E PEZZI SPECIALI

SPECIAL TRIMS . PIÈCES SPECIALES . SONDERSTÜCKE
PIEZAS ESPECIALES . СПЕЦИАЛЬНЫЕ ИЗДЕЛИЯ . 特别装饰

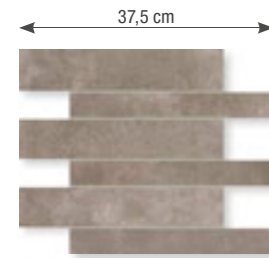

MOSAICO T16 30x30
1.



GRADONE 120x32x4
2.

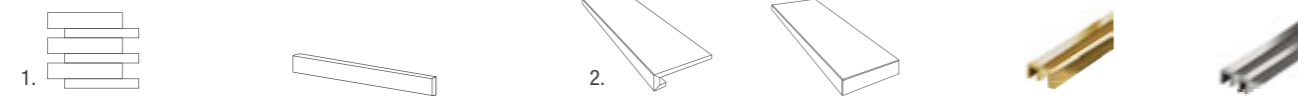

	MOSAICO T6 30x30	BATTISCOPA MOLATO		GRADONE 120x32x4	GRADONE ANGOLARE 120x32x4	PROFILI OTTONE	PROFILI ACCIAIO	
		8x60	8x80			[M]	[M]	
	SAND	56780	ML55650	ML56700	56630	56640 DX 56645 SX	119863 1x80 26231 1x60	119862 1x80 26230 1x60
	MUD	56782	ML55652	ML56702	56632	56642 DX 56647 SX	119861 0,5x80 26236 0,5x60	119860 0,5x80 26235 0,5x60
	SIVER	56781	ML55651	ML56701	56631	56641 DX 56646 SX		
	CONCRETE	56783	ML55653	ML56703	56633	56643 DX 56648 SX		



	ELEMENTO "L" 120x32x4 OUTDOOR 9 MM	ELEMENTO "L" 80x32x4 OUTDOOR 20 MM	GRADONE ARROTONDATO 80x40 OUTDOOR 20 MM	GRADONE BECCO CIVETTA 80x40 OUTDOOR 20 MM	ANGOLARE BORDO ARROTONDATO (KIT DX/SX) 160x40 OUTDOOR 20 MM	ANGOLARE BECCO CIVETTA (KIT DX/SX) 160x40 OUTDOOR 20 MM	
	SAND	56760	56670	56680	55610	55620	55630
	MUD	56762	56672	56682	55612	55622	55632
	SIVER	56761	56671	56681	55611	55621	55631
	CONCRETE	56763	56673	56683	55613	55623	55633

IMBALLI . PACKING . CONDITIONNEMENT . VERPACKUNGSEINHEITEN . EMBALAJES . УПАКОВКА . 包裝

EN 14411/UGL Bla

FORMATO SIZE	SPESSORE THICKNESS	PZ/SCAT. PCS/BOX	MQ/SCAT. SQM/BOXT	KG/SCAT. KG/BOX	SCAT./PAL BOX/PAL	MQ/PAL SQM/PAL	KG/PAL
80x180	9 mm	2	2,880	58,50	20	57,60	1170,00
80x80 TEXTURE	9 mm	2	1,280	24,50	40	51,20	980,00
40x80	9 mm	4	1,280	25,20	27	34,56	680,61
60x120	9 mm	2	1,440	29,52	26	37,44	767,52
60x60	9 mm	3	1,080	20,21	40	43,20	808,40
MOSAICO T6 30x30	9 mm	4	-	9,20	-	-	-
BATTISCOPA MOLATO 8x60	9 mm	10	6,00 ml	18,40	-	-	-
BATTISCOPA MOLATO 8x80	9 mm	10	8,00 ml	15,00	-	-	-
GRADONE 120x32x4	9 mm	2	2,40 ml	22,85	-	-	-
GRADONE ANGOLARE 120x32x4	9 mm	1	-	11,42	-	-	-
ELEMENTO "L" 120x32x4 OUTDOOR	9 mm	2	1,60 ml	14,00	-	-	-
80x80 OUTDOOR	20 mm	1	0,640	28,75	45	28,80	1293,75
ELEMENTO "L" 80x32x4 OUTDOOR	20 mm	2	1,60 ml	7,00	-	-	-
GRADONE BORDO ARROTONDATO 80x40 OUTDOOR	20 mm	2	1,60 ml	29,00	-	-	-
GRADONE BECCO DI CIVETTA 80x40 OUTDOOR	20 mm	2	1,60 ml	29,00	-	-	-
ANGOLARE BORDO ARROTONDATO 80x40 OUTDOOR	20 mm	1	-	25,00	-	-	-
ANGOLARE BECCO DI CIVETTA 80x40 OUTDOOR	20 mm	1	-	25,00	-	-	-
PROFILI METALLO 0,5x60 - 1x60	-	6	3,60 ml	2,70	-	-	-
PROFILI METALLO 0,5x80 - 1x80	-	6	4,80 ml	3,00	-	-	-

I DATI RELATIVI A IMBALLAGGI E PESI POSSONO SUBIRE DELLE VARIAZIONI . INFORMATIONS AND DETAILS RELATED TO PACKAGING AND WEIGHT ARE SUBJECT TO CHANGE
LES DONNÉES CONCERNANT EMBALLAGE ET POIDS SONT SUJETTES À VARIATIONS . DIE ANGABEN ÜBER VERPACKUNGEN UND GEWICHTE SIND NICHT BINDEND
LOS DATOS RELACIONADOS CON EL EMBALAJE Y LOS PESOS PUEDEN ESTAR SUJETOS A CAMBIOS . ДАННЫЕ, ОТНОСЯЩИЕСЯ К УПАКОВКЕ И ВЕСУ, ПОДЛЕЖАТ ИЗМЕНЕНИЯМ
与包装和重量有关的数据可能会更改

i Cementi

Walk

GRES FINE PORCELLANATO AD IMPASTO COLORATO

COLORBODY FINE PORCELAIN STONEWARE

GRES CÉRAME TEINTÉ DANS LA MASSE

FEINSGEINZEUG MIT EINGEFÄRBTEN SCHERBEN

GRES PORCELÁNICO MASA COLOREADA

ОКРАШЕННЫЙ ПО ВСЕ ТОЛЩИНЕ КЕРАМОГРАНИТ

彩色坯体瓷质玻化上釉砖



V2

9 MM



TECNOLOGIA AD ALTA DEFINIZIONE
HIGH-DEFINITION TECHNOLOGY

MOSAICI E DECORI



1 SUPERFICIE (NATURALE)

NATURAL SURFACE

SURFACE NATURELLE

NATÜRLICHE OBERFLÄCHE

SUPERFICIE NATURAL

НАТУРАЛЬНАЯ ПОВЕРХНОСТЬ

天然表面



R10

R10 GRUPPO B

DCOF > 0,42

ASTM C1028 > 0,60

BCRA W.D. > 0,40

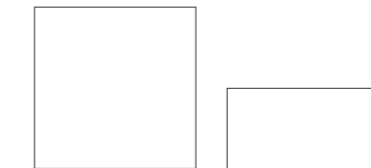

80x80
32"x32"

40x80
16"x32"



60x120
24"x48"



BIANCO V2



GRIGIO CHIARO V2



GRIGIO MEDIO V2



BEIGE V2



Walk





BIANCO

BEIGE

GRIGIO CHIARO

GRIGIO MEDIO



80x80
32"x32"



40x80
16"x32"



60x120
24"x48"

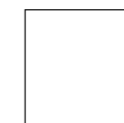

80x80
32"x32"



40x80
16"x32"



60x120
24"x48"

BIANCO	41205	41225	41415
BEIGE	41200	41220	41410

GRIGIO CHIARO	41204	41224	41414
GRIGIO MEDIO	41202	41222	41416

DECORI

DECORS / DÉCORATIONS / VERZIERUNGEN / DECORACIONES / УКРАШЕНИЯ / 装饰



40x80 VINTAGE BIANCO
41355



40x80 VINTAGE GRIGIO CHIARO
41354



40x80 VINTAGE BEIGE
41350



40x80 VINTAGE GRIGIO MEDIO
41352



20x80 NUOVOANTICO BIANCO
41342

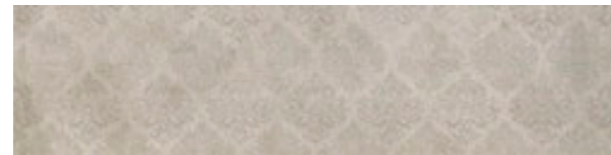

20x80 NUOVOANTICO GRIGIO CHIARO
41341

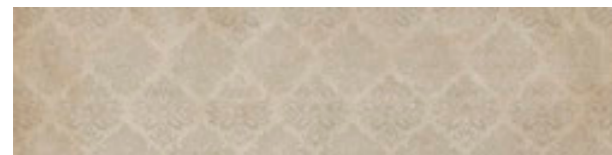

20x80 NUOVOANTICO BEIGE
41340

MOSAICO T20 DECORATO



33,3x33,3 BEIGE/GOLD
41300



33,3x33,3 GRIGIO/SILVER
41301

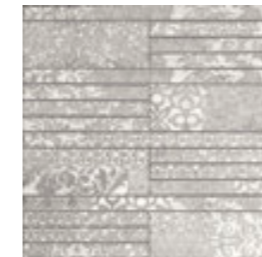

33,3x33,3 BIANCO/SILVER
41302

MOSAICO T36 DECORATO

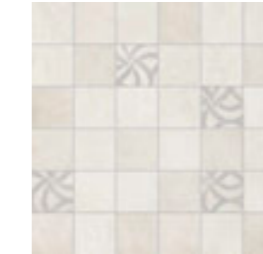

33,3x33,3 BIANCO
41325

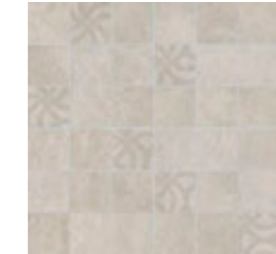

33,3x33,3 GRIGIO CHIARO
41324

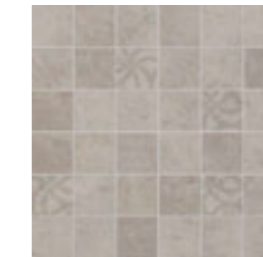

33,3x33,3 GRIGIO MEDIO
41322



33,3x33,3 BEIGE
41320



WALL: MOSAICO T36 DECORATO BEIGE 33,3x33,3

Walk

MOSAICI E PEZZI SPECIALI

SPECIAL TRIMS . PIECES SPECIALES . SONDERSTÜCKE
 PIEZAS ESPECIALES . СПЕЦИАЛЬНЫЕ ИЗДЕЛИЯ . 特别装饰

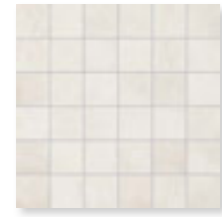

MOSAICO T36 33,3x33,3
1.



MOSAICO T20 33,3x33,3
2.



GRADONE 120x32x4
3.

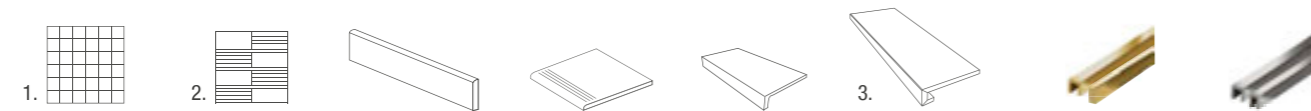

	MOSAICO T36 33,3x33,3	MOSAICO T20 33,3x33,3	BATTISCOPA 8x80	GRADINO MOLATO 40x40	ELEMENTO "L" 30x15x3,5	GRADONE 120x32x4	PROFILI OTTONE M	PROFILI ACCIAIO M
BIANCO	41315	41295	41405	41375	41385	41455	119863 1x80 26231 1x60	119862 1x80 26230 1x60
GRIGIO CHIARO	41314	41294	41404	41374	41384	41454	119861 0,5x80 26236 0,5x60	119860 0,5x80 26235 0,5x60
GRIGIO MEDIO	41312	41292	41402	41372	41382	41452		
BEIGE	41310	41290	41400	41370	41380	41450		

IMBALLI . PACKING . CONDITIONNEMENT . VERPACKUNGSEINHEITEN . EMBALAJES . УПАКОВКА . 包装

EN 14411/G Bla

FORMATO SIZE	SPESSORE THICKNESS	PZ/SCAT. PCS/BOX	MQ/SCAT. SQM/BOXT	KG/SCAT. KG/BOX	SCAT./PAL BOX/PAL	MQ/PAL SQM/PAL	KG/PAL
60x120	9 mm	2	1,440	29,52	26	37,44	767,82
80x80	9 mm	2	1,280	24,50	40	51,20	980,00
40x80	9 mm	4	1,280	25,20	27	34,56	680,61
MOSAICI 33,3x33,3	9 mm	4	0,443	9,60	-	-	-
DECORO NUOVOANTICO 20x80	9 mm	4	-	15,56	-	-	-
DECORO VINTAGE 40x80	9 mm	2	-	15,56	-	-	-
BATTISCOPA 8x80	9 mm	10	8,00 ml	15,00	-	-	-
GRADINO MOLATO 40x40	9 mm	4	1,60 ml	15,00	-	-	-
ELEMENTO "L" 30x15x3,5	9 mm	4	1,20 ml	5,60	-	-	-
GRADONE 120x32x4	9 mm	2	2,40 ml	22,85	-	-	-
PROFILI METALLO 0,5x60 - 1x60	-	6	3,60 ml	2,70	-	-	-
PROFILI METALLO 0,5x80 - 1x80	-	6	4,80 ml	3,00	-	-	-

I DATI RELATIVI A IMBALLAGGI E PESI POSSONO SUBIRE DELLE VARIAZIONI . INFORMATIONS AND DETAILS RELATED TO PACKAGING AND WEIGHT ARE SUBJECT TO CHANGE
 LES DONNÉES CONCERNANT EMBALLAGE ET POIDS SONT SUJETTES À VARIATIONS . DIE ANGABEN ÜBER VERPACKUNGEN UND GEWICHTE SIND NICHT BINDEND
 LOS DATOS RELACIONADOS CON EL EMBALAJE Y LOS PESOS PUEDEN ESTAR SUJETOS A CAMBIOS . ДАННЫЕ, ОТНОСЯЩИЕСЯ К УПАКОВКЕ И ВЕСУ, ПОДЛЕЖАТ ИЗМЕНЕНИЯМ
 与包装和重量有关的数据可能会更改



FLOOR: GRIGIO CHIARO 80x80

i Legni

pragetti

- 158 Just Life
- 170 Just Code
- 184 Just Color
- 198 Just Mix
- 212 Just Nature
- 226 Just Venice



i Legni

Just Life

GRES FINE PORCELLANATO AD IMPASTO COLORATO

COLORBODY FINE PORCELAIN STONEWARE
GRES CÉRAME TEINTÉ DANS LA MASSE
FEINSGEINZEUG MIT EINGEFÄRBTEN SCHERBEN
GRES PORCELÁNICO MASA COLOREADA
ОКРАШЕННЫЙ ПО ВСЕ ТОЛЩИНЕ КЕРАМОГРАНИТ
彩色坯体瓷质玻化上釉砖



TECNOLOGIA AD ALTA DEFINIZIONE
HIGH-DEFINITION TECHNOLOGY

MOSAICI E DECORI



2 SUPERFICI (NATURALI)

NATURAL SURFACES
SURFACES NATURELLES
NATÜRLICHE OBERFLÄCHEN
SUPERFICIES NATURALES
НАТУРАЛЬНАЯ ПОВЕРХНОСТЬ
天然表面



R10-R12

R10 GRUPPO B (INDOOR)

DCOF > 0,42
ASTM C1028 > 0,60
BCRA W.D. > 0,40
PTV FOUR 6 W.D. > 0,36

R12 GRUPPO C (OUTDOOR)

DCOF > 0,42
ASTM C1028 > 0,60
BCRA W.D. > 0,40
PTV FOUR 6 W.D. > 0,36



16x100
6"x40"

16x100
6"x40"



BEIGE CHIARO

V3



BEIGE BIONDO

V3



BEIGE SCURO

V3



NOCE ROSSO

V3



NOCE SCURO

V3



MUSCHIO

V3



SBIANCATO

V3



GRIGIO

V3







BEIGE CHIARO



BEIGE BIONDO



BEIGE SCURO





MUSCHIO



16x100
6"X40"

16x100 
6"X40"
OUTDOOR 9 MM

16x100
6"X40"

16x100 
6"X40"
OUTDOOR 9 MM

	BEIGE CHIARO	50103	-
	BEIGE BIONDO	50105	50135

	BEIGE SCURO	50106	50136
	MUSCHIO	50104	50134



NOCE ROSSO



NOCE SCURO



SBIANCATO





GRIGIO



16x100
6"x40"

16x100 
6"x40"
OUTDOOR 9 MM

16x100
6"x40"

16x100 
6"x40"
OUTDOOR 9 MM

	NOCE ROSSO	50107	50137
	NOCE SCURO	50108	-

	SBIANCATO	50100	-
	GRIGIO	50101	50131

Just Life

MOSAICI E PEZZI SPECIALI

SPECIAL TRIMS . PIECES SPECIALES . SONDERSTÜCKE
PIEZAS ESPECIALES . СПЕЦИАЛЬНЫЕ ИЗДЕЛИЯ . 特别装饰



GRADONE 100x32x4
1.

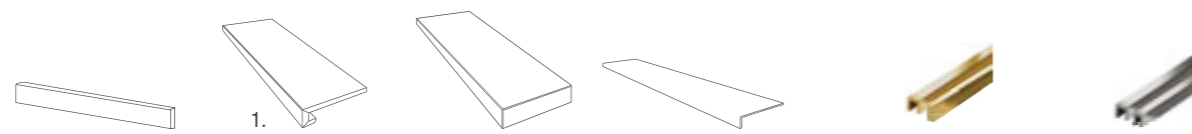

	BATTISCOPA MOLATO 8x100	GRADONE 100x32x4	GRADONE ANGOLARE 100x32x4	ELEMENTO "L" 100x32x4 OUTDOOR	PROFILI OTTONE	PROFILI ACCIAIO
					M	M
	BEIGE CHIARO	ML50103	50153	50163 DX 50173 SX	-	119862 1x80 26231 1x60
	BEIGE BIONDO	ML50105	50155	50165 DX 50175 SX	-	119861 0,5x80 26236 0,5x60
	BEIGE SCURO	ML50106	50156	50166 DX 50176 SX	50186	119860 0,5x80 26235 0,5x60
	MUSCHIO	ML50104	50154	50164 DX 50174 SX	50184	
	NOCE ROSSO	ML50107	50157	50167 DX 50177 SX	50187	
	NOCE SCURO	ML50108	50158	50168 DX 50178 SX	-	
	SBIANCATO	ML50100	50150	50160 DX 50170 SX	-	
	GRIGIO	ML50101	50151	50161 DX 50171 SX	50181	

IMBALLI . PACKING . CONDITIONNEMENT . VERPACKUNGSEINHEITEN . EMBALAJES . УПАКОВКА . 包裝

EN 14411/G Bla

FORMATO SIZE	SPESSORE THICKNESS	PZ/SCAT. PCS/BOX	MQ/SCAT. SQM/BOXT	KG/SCAT. KG/BOX	SCAT./PAL BOX/PAL	MQ/PAL SQM/PAL	KG/PAL
16x100	9 mm	7	1,120	21,20	64	71,68	1356,80
BATTISCOPA 8x100	9 mm	4	4,00 ml	7,36	-	-	-
GRADONE 100x32x4	9 mm	2	2,00 ml	18,00	-	-	-
GRADONE ANGOLARE 100x32x4	9 mm	1	-	9,00	-	-	-
ELEMENTO "L" 100x32x4 OUTDOOR	9 mm	2	-	16,00	-	-	-
PROFILI METALLO 0,5x60 - 1x60	-	6	3,60 ml	2,70	-	-	-
PROFILI METALLO 0,5x80 - 1x80	-	6	4,80 ml	3,00	-	-	-

I DATI RELATIVI A IMBALLAGGI E PESI POSSONO SUBIRE DELLE VARIAZIONI . INFORMATIONS AND DETAILS RELATED TO PACKAGING AND WEIGHT ARE SUBJECT TO CHANGE
LES DONNÉES CONCERNANT EMBALLAGE ET POIDS SONT SUJETTES À VARIATIONS . DIE ANGABEN ÜBER VERPACKUNGEN UND GEWICHTE SIND NICHT BINDEND
LOS DATOS RELACIONADOS CON EL EMBALAJE Y LOS PESOS PUEDEN ESTAR SUJETOS A CAMBIOS . ДАННЫЕ, ОТНОСЯЩИЕСЯ К УПАКОВКЕ И ВЕСУ, ПОДЛЕЖАТ ИЗМЕНЕНИЯМ
与包装和重量有关的数据可能会更改



FLOOR: GRIGIO 16x100



i Legni

Just Code

GRES FINE PORCELLANATO AD IMPASTO COLORATO

COLORBODY FINE PORCELAIN STONEWARE
GRES CÉRAME TEINTÉ DANS LA MASSE
FEINSGEINZEUG MIT EINGEFÄRBTEN SCHERBEN
GRES PORCELÁNICO MASA COLOREADA
ОКРАШЕННЫЙ ПО ВСЕ ТОЛЩИНЕ КЕРАМОГРАНИТ
彩色坯体瓷质玻化上釉砖



TECNOLOGIA AD ALTA DEFINIZIONE
HIGH-DEFINITION TECHNOLOGY

MOSAICI E DECORI



2 SUPERFICI (NATURALI)

NATURAL SURFACES
SURFACES NATURELLES
NATÜRLICHE OBERFLÄCHEN
SUPERFICIES NATURALES
НАТУРАЛЬНАЯ ПОВЕРХНОСТЬ
天然表面



R10-R11

R10 GRUPPO B (INDOOR)
DCOF > 0,42
ASTM C1028 > 0,60
BCRA W.D. > 0,40
PTV FOUR 6 W.D. > 0,36

R11 GRUPPO C (OUTDOOR)
DCOF > 0,42
ASTM C1028 > 0,60
BCRA W.D. > 0,40
PTV FOUR 6 W.D. > 0,36

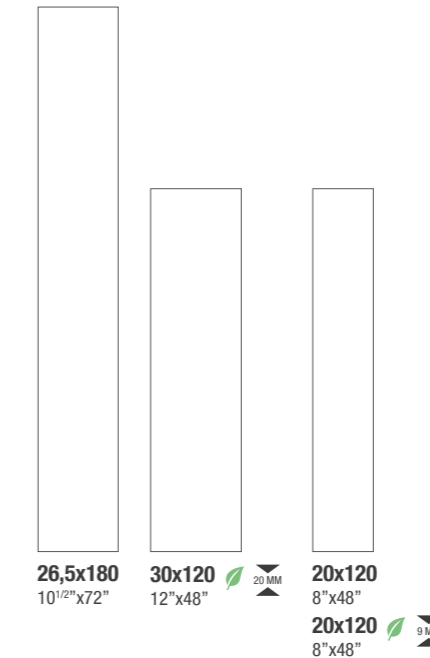



FLOOR: WHITE 26,5x180
WALL: MOSAICO DIAPASON CALDO



FLOOR: DARK 20x120
WALL: SAND 20x120 - MOSAICO DIAPASON FREDDO

















MIELE

SAND

BEIGE

GREIGE

				
	26,5x180 10 ¹ / ₂ "x72"	20x120 8"x48"	20x120 8"x48" OUTDOOR 9 MM	30x120 12"x48" OUTDOOR 20 MM
 MIELE	75005	75025	75095	75115
 SAND	75000	75020	-	-

				
	26,5x180 10 ¹ / ₂ "x72"	20x120 8"x48"	20x120 8"x48" OUTDOOR 9 MM	30x120 12"x48" OUTDOOR 20 MM
 BEIGE	75001	75021	-	-
 GREIGE	75004	75024	75094	75114



WHITE



GRIGIO

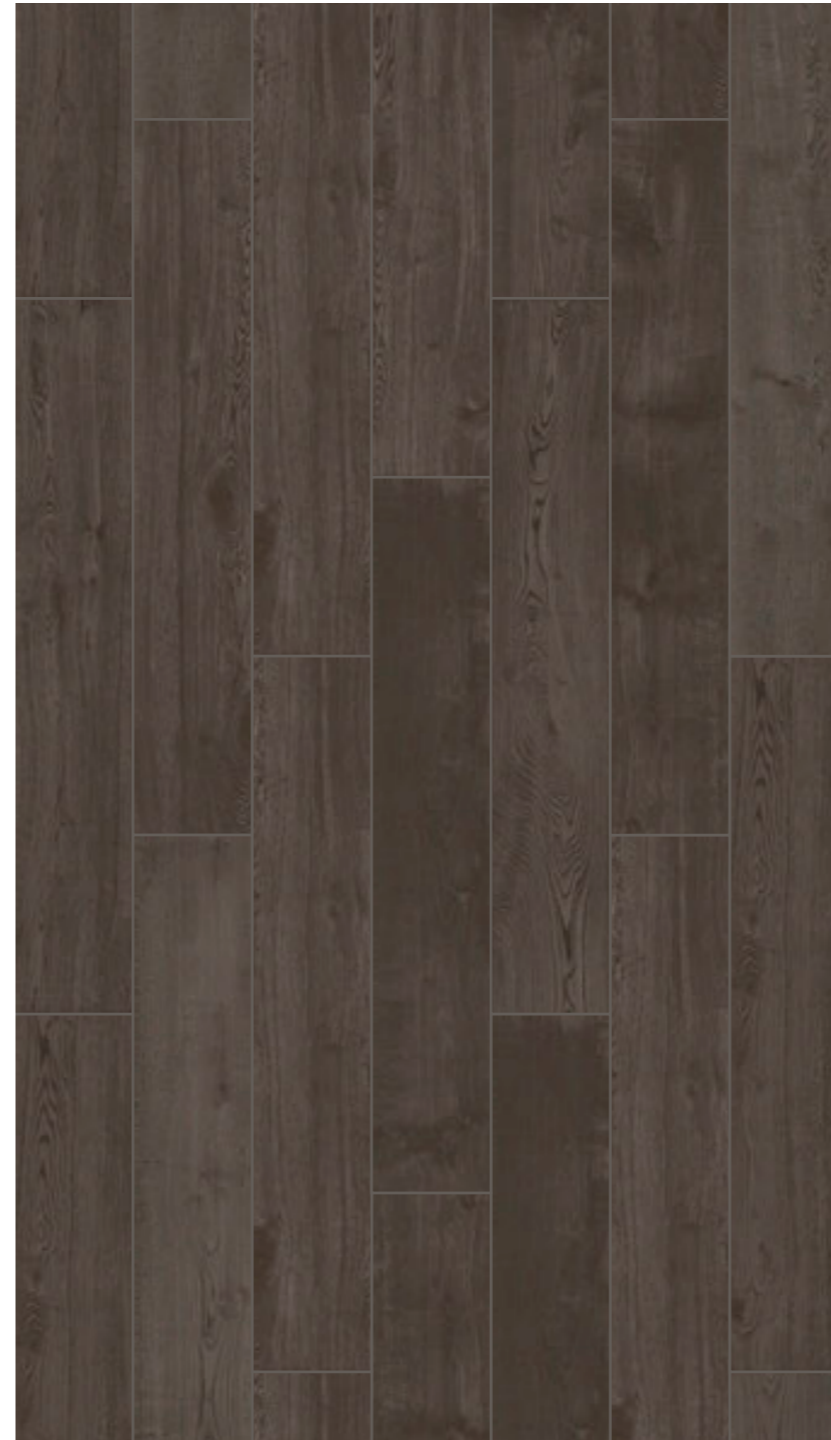

DARK



26,5x180
10¹/₂"x72"

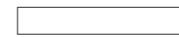



20x120
8"x48"

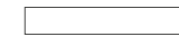

26,5x180
10¹/₂"x72"













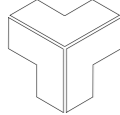

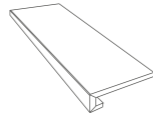
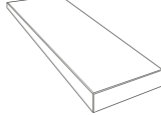

20x120
8"x48"









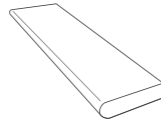
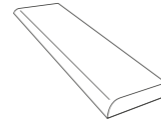
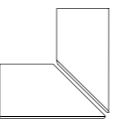
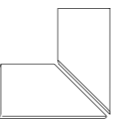

	WHITE	75006	75026
	GRIGIO	75003	75023

	DARK	75002	75022
---	------	-------	-------

MOSAICI E PEZZI SPECIALI

SPECIAL TRIMS . PIECES SPECIALES . SONDERSTÜCKE
PIEZAS ESPECIALES . СПЕЦИАЛЬНЫЕ ИЗДЕЛИЯ . 特别装饰

						
	DIAPASON 18,8x21,7 	BATTISCOPA MOLATO 6X120	GRADONE 120x32x4	GRADONE ANGOLARE 120x32x4	PROFILI OTTONE 	PROFILI ACCIAIO 
 MIELE	75050 (caldo)	ML75025	75065	75085 Sx 75075 Dx	119863 1x80 26231 1x60	119862 1x80 26230 1x60
 SAND		ML75020	75060	75080 Sx 75070 Dx	119861 0,5x80 26236 0,5x60	119860 0,5x80 26235 0,5x60
 BEIGE		ML75021	75061	75081 Sx 75071 Dx		
 GREIGE		ML75024	75064	75084 Sx 75074 Dx		
 WHITE	75052 (white/dark)	ML75026	75066	75086 Sx 75076 Dx		
 GRIGIO	75051 (freddo)	ML75023	75063	75083 Sx 75073 Dx		
 DARK		ML75022	75062	75082 Sx 75072 Dx		

						
	ELEMENTO AD "L" 120x32x4 OUTDOOR 9 MM 	ELEMENTO AD "L" 120x30x4 OUTDOOR 20 MM 	GRADONE BORDO ARROTONDATO 120x30 OUTDOOR 20 MM 	GRADONE BECCO CIVETTA 120x30 OUTDOOR 20 MM 	ANGOLARE BORDO ARROTONDATO (KIT DX/SX) 240x30 OUTDOOR 20 MM 	ANGOLARE BECCO CIVETTA (KIT DX/SX) 240x30 OUTDOOR 20 MM 
 MIELE	75105	75125	75145	75155	75165	75175
 GREIGE	75104	75124	75144	75154	75164	75174

IMBALLI . PACKING . CONDITIONNEMENT . VERPACKUNGSEINHEITEN . EMBALAJES . УПАКОВКА . 包裝

EN 14411/G Bla

FORMATO SIZE	SPESSORE THICKNESS	PZ/SCAT. PCS/BOX	MQ/SCAT. SQM/BOXT	KG/SCAT. KG/BOX	SCAT./PAL BOX/PAL	MQ/PAL SQM/PAL	KG/PAL
26,5x180	9 mm	3	1,431	30,60	42	60,10	1285,20
20x120	9 mm	5	1,200	24,16	48	57,60	1159,68
20x120 OUTDOOR	9 mm	5	1,200	24,16	48	57,60	1159,68
MOSAICO DIAPASON	9 mm	4	-	9,60	-	-	-
BATTISCOPA 6x120	9 mm	6	7,2 ml	12,00	-	-	-
GRADONE 120x32x4	9 mm	2	2,40 ml	22,85	-	-	-
GRADONE ANGOLARE 120x32x4	9 mm	1	-	11,42	-	-	-
ELEMENTO "L" 120x34x4	9 mm	2	2,40 ml	22,85	-	-	-
30x120 OUTDOOR	20 mm	2	0,720	30,84	36	25,92	1110,24
ELEMENTO "L" 120x30x4 OUTDOOR	20 mm	2	2,40 ml	-	-	-	-
GRADONE BORDO ARROTONDATO 120x30 OUTDOOR	20 mm	2	-	29,00	-	-	-
GRADONE BECCO DI CIVETTA 120x30 OUTDOOR	20 mm	2	-	29,00	-	-	-
ANGOLARE BORDO ARROTONDATO 240x30 OUTDOOR	20 mm	2	-	25,00	-	-	-
ANGOLARE BECCO DI CIVETTA 240x30 OUTDOOR	20 mm	2	-	25,00	-	-	-
PROFILI METALLO 0,5x60 - 1x60	-	6	3,60 ml	2,70	-	-	-
PROFILI METALLO 0,5x80 - 1x80	-	6	4,80 ml	3,00	-	-	-

I DATI RELATIVI A IMBALLAGGI E PESI POSSONO SUBIRE DELLE VARIAZIONI . INFORMATIONS AND DETAILS RELATED TO PACKAGING AND WEIGHT ARE SUBJECT TO CHANGE
LES DONNÉES CONCERNANT EMBALLAGE ET POIDS SONT SUJETTES À VARIATIONS . DIE ANGABEN ÜBER VERPACKUNGEN UND GEWICHTE SIND NICHT BINDEND
LOS DATOS RELACIONADOS CON EL EMBALAJE Y LOS PESOS PUEDEN ESTAR SUJETOS A CAMBIOS . ДАННЫЕ, ОТНОСЯЩИЕСЯ К УПАКОВКЕ И ВЕСУ, ПОДЛЕЖАТ ИЗМЕНЕНИЯМ
与包装和重量有关的数据可能会更改



FLOOR: GRIGIO 20x120

i Legni

Just Color

GRES FINE PORCELLANATO AD IMPASTO COLORATO

COLORBODY FINE PORCELAIN STONEWARE

GRES CÉRAME TEINTÉ DANS LA MASSE

FEINSGEINZEUG MIT EINGEFÄRBTEN SCHERBEN

GRES PORCELÁNICO MASA COLOREADA

ОКРАШЕННЫЙ ПО ВСЕ ТОЛЩИНЕ КЕРАМОГРАНИТ

彩色坯体瓷质玻化上釉砖



9 MM



TECNOLOGIA AD ALTA DEFINIZIONE
HIGH-DEFINITION TECHNOLOGY

MOSAICI E DECORI



1 SUPERFICIE (NATURALE)

NATURAL SURFACE

SURFACE NATURELLE

NATÜRLICHE OBERFLÄCHE

SUPERFICIE NATURAL

НАТУРАЛЬНАЯ ПОВЕРХНОСТЬ

天然表面



R10

R10 GRUPPO A

ANSI A137.1.2012 - DCOF > 0.42

ASTM C1028 - W.D. > 0.60

BCRA - W.D. > 0.40

BS 7976.2.2002 FOUR S - W.D. > 0.36



20x120
8"x48"



ALMOND V4



HONEY V4



BROWN V4



WHITE V4



GREY V4



BLACK V4

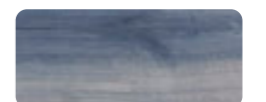

BLUE V4

Just Color



FLOOR: BROWN 20x120

Just Color



FLOOR: BLUE 20x120

i Legni



FLOOR: WHITE 20x120
WALL: WHITE 20x120

Just Color



FLOOR: Grey 20x120



WHITE



GREY



BLACK



BLUE



20x120
8"x48"

	WHITE	58600
	GREY	58606



20x120
8"x48"

	BLACK	58605
	BLUE	58604



ALMOND



HONEY



BROWN



ALMOND 20x120



20x120
8"x48"

	ALMOND	58601
	HONEY	58602

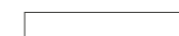

20x120
8"x48"

	BROWN	58603
---	-------	-------

Just Color

DECORI

DECORS . DÉCORATIONS . VERZIERUNGEN . DECORACIONES . УКРАШЕНИЯ . 装饰



20x120 CHEVRON MIX WARM
58611

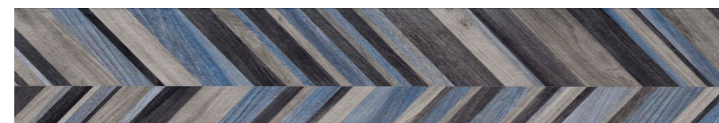

20x120 CHEVRON MIX COLD
58610



GRADONE 120x32x4
1.

PEZZI SPECIALI

SPECIAL TRIMS . PIÈCES SPECIALES . SONDERSTÜCKE . PIEZAS ESPECIALES . СПЕЦИАЛЬНЫЕ ИЗДЕЛИЯ . 特别装饰

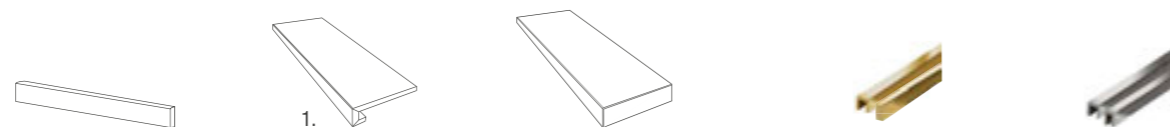

	BATTISCOPA MOLATO 6x120	GRADONE 120x32x4	GRADONE ANGOLARE 120x32x4	PROFILI OTTONE M	PROFILI ACCIAIO M
WHITE	ML58600	58640	58650 DX 58660 SX	119863 1x80 26231 1x60	119862 1x80 26230 1x60
ALMOND	ML58601	58641	58651 DX 58661 SX	119861 0,5x80 26236 0,5x60	119860 0,5x80 26235 0,5x60
HONEY	ML58602	58642	58652 DX 58662 SX		
BROWN	ML58603	58643	58653 DX 58663 SX		
GREY	ML58606	58646	58656 DX 58666 SX		
BLACK	ML58605	58645	58655 DX 58665 SX		
BLUE	ML58604	58644	58654 DX 58664 SX		

IMBALLI . PACKING . CONDITIONNEMENT . VERPACKUNGSEINHEITEN . EMBALAJES . УПАКОВКА . 包装

EN 14411/G Bla

FORMATO SIZE	SPESSORE THICKNESS	PZ/SCAT. PCS/BOX	MQ/SCAT. SQM/BOXT	KG/SCAT. KG/BOX	SCAT./PAL BOX/PAL	MQ/PAL SQM/PAL	KG/PAL
PAVIMENTO 20x120	9 mm	5	1,200	24,16	48	57,60	1159,68
DECORO 20x120	9 mm	5	1,200	26,16	48	57,60	1159,68
BATTISCOPA MOLATO 6x120	9 mm	6	7,20 ml	12,00	-	-	-
GRADONE 120x32x4	9 mm	2	2,40 ml	22,84	-	-	-
GRADONE ANGOLARE 120x32x4	9 mm	1	-	13,00	-	-	-
PROFILI METALLO 0,5x60 - 1x60	-	6	3,60 ml	2,70	-	-	-
PROFILI METALLO 0,5x80 - 1x80	-	6	4,80 ml	3,00	-	-	-

I DATI RELATIVI A IMBALLAGGI E PESI POSSONO SUBIRE DELLE VARIAZIONI . INFORMATIONS AND DETAILS RELATED TO PACKAGING AND WEIGHT ARE SUBJECT TO CHANGE
LES DONNÉES CONCERNANT EMBALLAGE ET POIDS SONT SUJETTES À VARIATIONS . DIE ANGABEN ÜBER VERPACKUNGEN UND GEWICHTE SIND NICHT BINDEND
LOS DATOS RELACIONADOS CON EL EMBALAJE Y LOS PESOS PUEDEN ESTAR SUJETOS A CAMBIOS . ДАННЫЕ, ОТНОСЯЩИЕСЯ К УПАКОВКЕ И ВЕСУ, ПОДЛЕЖАТ ИЗМЕНЕНИЯМ
与包装和重量有关的数据可能会更改



FLOOR: BLACK 20x120
WALL: BLACK 20x120

i Legni

Just Mix

GRES FINE PORCELLANATO AD IMPASTO COLORATO

COLORBODY FINE PORCELAIN STONEWARE
GRES CÉRAME TEINTÉ DANS LA MASSE
FEINSGEINZEUG MIT EINGEFÄRBTEN SCHERBEN
GRES PORCELÁNICO MASA COLOREADA
ОКРАШЕННЫЙ ПО ВСЕ ТОЛЩИНЕ КЕРАМОГРАНИТ
彩色坯体瓷质玻化上釉砖



TECNOLOGIA AD ALTA DEFINIZIONE
HIGH-DEFINITION TECHNOLOGY

MOSAICI E DECORI



2 SUPERFICI (NATURALI)

NATURAL SURFACES
SURFACES NATURELLES
NATÜRLICHE OBERFLÄCHEN
SUPERFICIES NATURALES
НАТУРАЛЬНАЯ ПОВЕРХНОСТЬ
天然表面



R10-R11

R10 GRUPPO B (INDOOR)
DCOF > 0,42
ASTM C1028 > 0,60
BCRA W.D. > 0,40
PTV FOUR 6 W.D. > 0,36

R11 GRUPPO C (OUTDOOR)
DCOF > 0,42
ASTM C1028 > 0,60
BCRA W.D. > 0,40
PTV FOUR 6 W.D. > 0,36

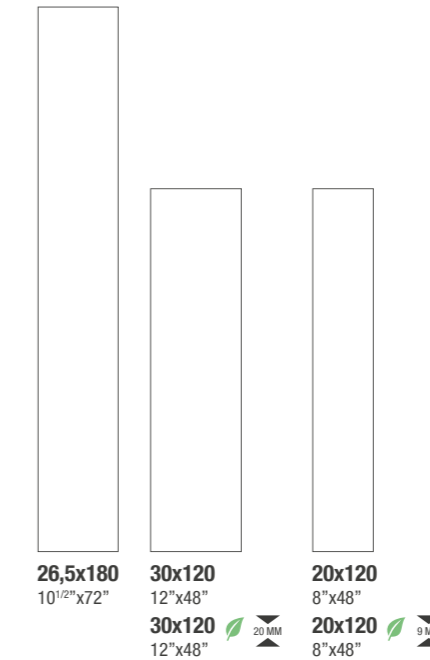

Just Mix









WALL: MIELE 20x120
FLOOR: BROWN 20x120 - MOSAICO DIAPASON CALDO



FLOOR/WALL: BROWN 20x120



BIANCO

GRIGIO

MIELE

BROWN

26,5x180 10 ¹ / ₂ "x72"	30x120 12"x48"	20x120 8"x48"	20x120 8"x48" OUTDOOR 9 MM	30x120 12"x48" OUTDOOR 20 MM











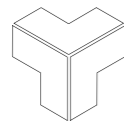

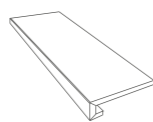
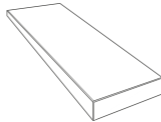
26,5x180 10 ¹ / ₂ "x72"	30x120 12"x48"	20x120 8"x48"	20x120 8"x48" OUTDOOR 9 MM	30x120 12"x48" OUTDOOR 20 MM











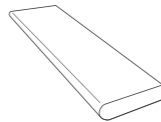
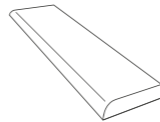
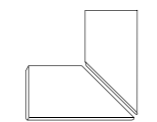
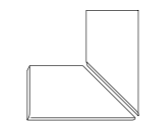

	BIANCO	75540	75510	75500	75610	75520
	GRIGIO	75542	75512	75502	75612	75522

	MIELE	75541	75511	75501	75611	75521
	BROWN	75543	75513	75503	75613	75523

MOSAICI E PEZZI SPECIALI

SPECIAL TRIMS . PIÈCES SPECIALES . SONDERSTÜCKE
PIEZAS ESPECIALES . СПЕЦИАЛЬНЫЕ ИЗДЕЛИЯ . 特别装饰

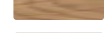
						
	DIAPASON 18,8x21,7 	BATTISCOPA MOLATO 6X120	GRADONE 120x32x4	GRADONE 120x32x4	PROFILI OTTONE 	PROFILI ACCIAIO 
 BIANCO	75561 (freddo)	ML75500	75580	75600 Sx 75590 Dx	119863 1x80 26231 1x60	119862 1x80 26230 1x60
 GRIGIO		ML75502	75582	75602 Sx 75592 Dx	119861 0,5x80 26236 0,5x60	119860 0,5x80 26235 0,5x60
 MIELE	75560 (caldo)	ML75501	75581	75601 Sx 75591 Dx		
 BROWN		ML75503	75583	75603 Sx 75593 Dx		

						
	ELEMENTO AD "L" 120x32x4 OUTDOOR 9 MM 	ELEMENTO AD "L" 120x32x4 OUTDOOR 20 MM 	GRADONE BORDO ARROTONDATO 120x30 OUTDOOR 20 MM 	GRADONE BECCO CIVETTA 120x30 OUTDOOR 20 MM 	ANGOLARE BORDO ARROTONDATO (KIT DX/SX) 240x30 OUTDOOR 20 MM 	ANGOLARE BECCO CIVETTA (KIT DX/SX) 240x30 OUTDOOR 20 MM 
 BIANCO	75620	75630	75650	75660	75670	75530
 GRIGIO	75622	75632	75652	75662	75672	75532
 MIELE	75621	75631	75651	75661	75671	75531
 BROWN	75623	75633	75653	75663	75673	75533

IL COLORE BROWN E' CARATTERIZZATO DA UNA FORTE STONALIZZAZIONE . THE BROWN COLOUR IS DISTINGUISHED BY A HIGH SHADE VARIATION
LE COLORIS BROWN EST CARACTÉRISÉ PAR UN FORT DÉNUANÇAGE . DIE FARBE BROWN IST DURCH EINE STARKE STONALISIERUNG CHARAKTERISIERT
EL COLOR MARRÓN SE CARACTERIZA POR UNA FUERTE STONALIZATION . ЦВЕТ BROWN ИМЕЕТ СИЛЬНЫЕ ЦВЕТОВЫЕ ИЗМЕНЕНИЯ
棕色具有强烈的阴影

IMBALLI . PACKING . CONDITIONNEMENT . VERPACKUNGSEINHEITEN . EMBALAJES . УПАКОВКА . 包裝

EN 14411/G Bla

FORMATO SIZE	SPESSORE THICKNESS	PZ/SCAT. PCS/BOX	MQ/SCAT. SQM/BOXT	KG/SCAT. KG/BOX	SCAT./PAL BOX/PAL	MQ/PAL SQM/PAL	KG/PAL
26,5x180	9 mm	3	1,431	30,60	42	60,10	1285,20
30x120	9 mm	3	1,080	20,28	36	38,88	730,08
20x120	9 mm	5	1,200	24,16	48	57,60	1159,68
MOSAICO DIAPASON 18,8x21,7	9 mm	4	-	9,40	-	-	-
BATTISCOPA 6x120	9 mm	6	7,90 ml	12,00	-	-	-
GRADONE 120x32x4	9 mm	2	2,40 ml	22,85	-	-	-
GRADONE ANGOLARE 120x32x4	9 mm	1	-	11,42	-	-	-
ELEMENTO "L" 120x34x4 OUTDOOR	9 mm	2	2,40 ml	22,85	-	-	-
30x120 OUTDOOR	20 mm	2	0,720	30,84	36	42,83	1110,24
ELEMENTO "L" 120x30x4 OUTDOOR	20 mm	2	-	32,00	-	-	-
GRADONE BORDO ARROTONDATO 120x30 OUTDOOR	20 mm	2	-	29,00	-	-	-
GRADONE BECCO DI CIVETTA 120x30 OUTDOOR	20 mm	2	-	29,00	-	-	-
ANGOLARE BORDO ARROTONDATO 240x30 OUTDOOR	20 mm	2	-	25,00	-	-	-
ANGOLARE BECCO DI CIVETTA 240x30 OUTDOOR	20 mm	2	-	25,00	-	-	-
PROFILI METALLO 0,5x60 - 1x60	9 mm	6	3,60 ml	2,70	-	-	-
PROFILI METALLO 0,5x80 - 1x80	9 mm	6	4,80 ml	3,00	-	-	-

I DATI RELATIVI A IMBALLAGGI E PESI POSSONO SUBIRE DELLE VARIAZIONI . INFORMATIONS AND DETAILS RELATED TO PACKAGING AND WEIGHT ARE SUBJECT TO CHANGE
LES DONNÉES CONCERNANT EMBALLAGE ET POIDS SONT SUJETTES À VARIATIONS . DIE ANGABEN ÜBER VERPACKUNGEN UND GEWICHTE SIND NICHT BINDEND
LOS DATOS RELACIONADOS CON EL EMBALAJE Y LOS PESOS PUEDEN ESTAR SUJETOS A CAMBIOS . ДАННЫЕ, ОТНОСЯЩИЕСЯ К УПАКОВКЕ И ВЕСУ, ПОДЛЕЖАТ ИЗМЕНЕНИЯМ
与包装和重量有关的数据可能会更改

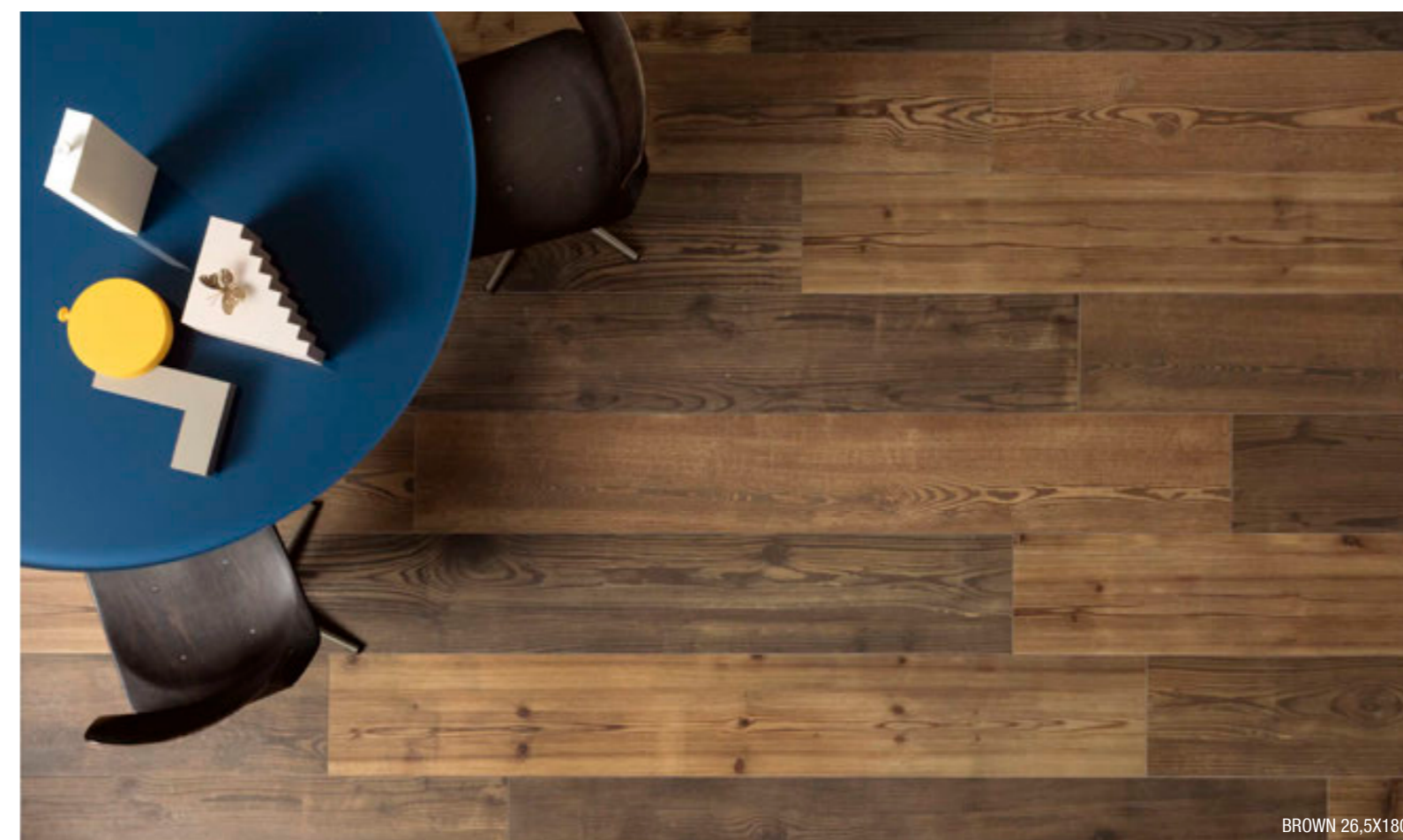

BROWN 26,5X180

i Legni

Just Nature

GRES FINE PORCELLANATO AD IMPASTO COLORATO

COLORBODY FINE PORCELAIN STONEWARE
GRES CÉRAME TEINTÉ DANS LA MASSE
FEINSGEINZEUG MIT EINGEFÄRBTEN SCHERBEN
GRES PORCELÁNICO MASA COLOREADA
ОКРАШЕННЫЙ ПО ВСЕ ТОЛЩИНЕ КЕРАМОГРАНИТ
彩色坯体瓷质玻化上釉砖



TECNOLOGIA AD ALTA DEFINIZIONE
HIGH-DEFINITION TECHNOLOGY

MOSAICI E DECORI



2 SUPERFICI (NATURALI)

NATURAL SURFACES
SURFACES NATURELLES
NATÜRLICHE OBERFLÄCHEN
SUPERFICIES NATURALES
НАТУРАЛЬНАЯ ПОВЕРХНОСТЬ
天然表面



R10-R11

R10 GRUPPO B (INDOOR)
DCOF > 0,42
ASTM C1028 > 0,60
BCRA W.D. > 0,40
PTV FOUR 6 W.D. > 0,36

R11 GRUPPO C (OUTDOOR)
DCOF > 0,42
ASTM C1028 > 0,60
BCRA W.D. > 0,40
PTV FOUR 6 W.D. > 0,36

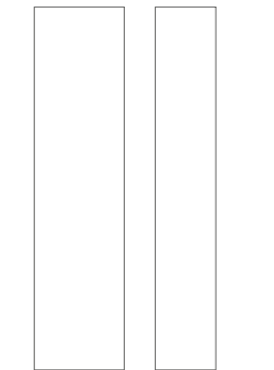

30x120
12"x48"

20x120
8"x48"

20x120
8"x48"



BEIGE CHIARO V3



BEIGE MEDIO V3



BEIGE SCURO V3



NOCE SCURO V3



SBIANCATO V3



GRIGIO V3





FLOOR / WALL: BEIGE MEDIO 20x120



FLOOR / WALL: BEIGE MEDIO 20x120



FLOOR: SBIANCATO 20x120



FLOOR: GRIGIO 20x120

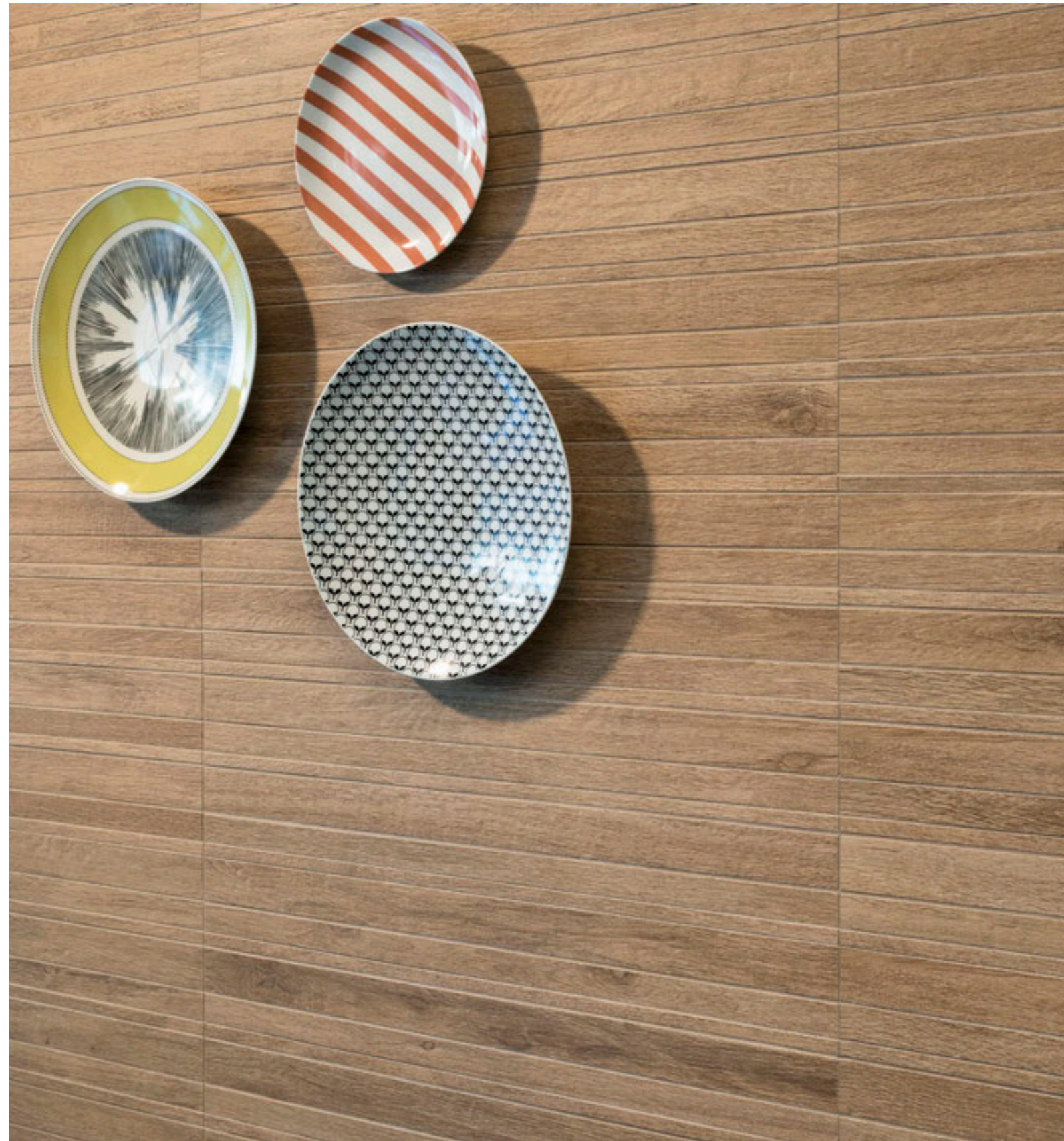

WALL: BEIGE SCURO MOSAICO LISTELLATO T12 30x60



FLOOR: BEIGE SCURO 20x120
WALL: BEIGE SCURO MOSAICO LISTELLATO T12 30x60



BEIGE CHIARO

BEIGE MEDIO

BEIGE SCURO

NOCE SCURO



30x120
12"x48"



20x120
8"x48"



20x120
8"x48"
OUTDOOR 9 MM





30x120
12"x48"



20x120
8"x48"



20x120
8"x48"
OUTDOOR 9 MM

	BEIGE CHIARO	52002	52012	-
	BEIGE MEDIO	52006	52016	52136

	BEIGE SCURO	52003	52013	52133
	NOCE SCURO	52005	52015	52135



SBIANCATO



GRIGIO

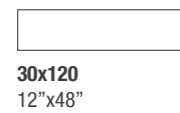

30x120
12"x48"

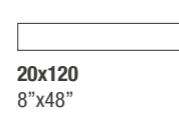

20x120
8"x48"



20x120
8"x48"
OUTDOOR 9 MM

	SBIANCATO	52000	52010	52130
	GRIGIO	52001	52011	52131

MOSAICI E PEZZI SPECIALI

SPECIAL TRIMS . PIECES SPECIALES . SONDERSTÜCKE
PIEZAS ESPECIALES . СПЕЦИАЛЬНЫЕ ИЗДЕЛИЯ . 特别装饰



MOSAICO LISTELLATO T12 30x60
1.



MOSAICO LISTELLATO T18 30x30
2.



GRADONE 120x32x4
3.

	1.	2.	3.					
	MOS. LISTELLATO T12 30X60	MOS. LISTELLATO T18 30X30	BATTISCOPA MOLATO 7X120	GRADONE 120x32x4	GRADONE ANGOLARE 120x32x4	PROFILI OTTONE	PROFILI ACCIAIO	
	BEIGE CHIARO	52092	52082	ML52002	52102	52112 DX 52122 SX	119863 1x80 26231 1x60	119862 1x80 26230 1x60
	BEIGE MEDIO	52096	52086	ML52006	52106	52116 DX 52126 SX	119861 0,5x80 26236 0,5x60	119860 0,5x80 26235 0,5x60
	BEIGE SCURO	52093	52083	ML52003	52103	52113 DX 52123 SX		
	NOCE SCURO	52095	52085	ML52005	52105	52115 DX 52125 SX		
	SBIANCATO	52090	52080	ML52000	52100	52110 DX 52120 SX		
	GRIGIO	52091	52081	ML52001	52101	52111 DX 52121 SX		

IMBALLI . PACKING . CONDITIONNEMENT . VERPACKUNGSEINHEITEN . EMBALAJES . УПАКОВКА . 包裝

EN 14411/G Bla

FORMATO SIZE	SPESSORE THICKNESS	PZ/SCAT. PCS/BOX	MQ/SCAT. SQM/BOXT	KG/SCAT. KG/BOX	SCAT./PAL BOX/PAL	MQ/PAL SQM/PAL	KG/PAL
30x120	9 mm	3	1,080	20,28	36	38,88	730,08
20x120	9 mm	5	1,200	24,16	48	57,60	1159,68
MOSAICO T12 30x60	9 mm	4	0,720	9,20	-	-	-
MOSAICO T18 30x30	9 mm	4	0,360	9,20	-	-	-
BATTISCOPA 7x120	9 mm	4	4,80 ML	8,40	-	-	-
GRADONE 120x32x4	9 mm	2	2,40 ML	22,85	-	-	-
GRADONE ANGOLARE 120x32x4	9 mm	1	1,20 ML	13,00	-	-	-
PROFILI METALLO 0,5x60 - 1x60	-	6	3,60 ML	2,70	-	-	-
PROFILI METALLO 0,5x80 - 1x80	-	6	4,80 ML	3,00	-	-	-

I DATI RELATIVI A IMBALLAGGI E PESI POSSONO SUBIRE DELLE VARIAZIONI . INFORMATIONS AND DETAILS RELATED TO PACKAGING AND WEIGHT ARE SUBJECT TO CHANGE
LES DONNÉES CONCERNANT EMBALLAGE ET POIDS SONT SUJETTES À VARIATIONS . DIE ANGABEN ÜBER VERPACKUNGEN UND GEWICHTE SIND NICHT BINDEND
LOS DATOS RELACIONADOS CON EL EMBALAJE Y LOS PESOS PUEDEN ESTAR SUJETOS A CAMBIOS . ДАННЫЕ, ОТНОСЯЩИЕСЯ К УПАКОВКЕ И ВЕСУ, ПОДЛЕЖАТ ИЗМЕНЕНИЯМ
与包装和重量有关的数据可能会更改



FLOOR: BEIGE CHIARO 26,5x180

i Legni

Just Venice

GRES FINE PORCELLANATO AD IMPASTO COLORATO

COLORBODY FINE PORCELAIN STONEWARE
 GRES CÉRAMÉ TEINTÉ DANS LA MASSE
 FEINSGEINZEUG MIT EINGEFÄRBTEN SCHERBEN
 GRES PORCELÁNICO MASA COLOREADA
 ОКРАШЕННЫЙ ПО ВСЕ ТОЛЩИНЕ КЕРАМОГРАНИТ
 彩色坯体瓷质玻化上釉砖



TECNOLOGIA AD ALTA DEFINIZIONE
 HIGH-DEFINITION TECHNOLOGY

MOSAICI E DECORI



2 SUPERFICI (NATURALI)

NATURAL SURFACES
 SURFACES NATURELLES
 NATÜRLICHE OBERFLÄCHEN
 SUPERFICIES NATURALES
 НАТУРАЛЬНАЯ ПОВЕРХНОСТЬ
 天然表面



R10-R11

R10 GRUPPO B (INDOOR)
 DCOF > 0,42
 ASTM C1028 > 0,60
 BCRA W.D. > 0,40
 PTV FOUR 6 W.D. > 0,36

R11 GRUPPO B (OUTDOOR)
 DCOF > 0,42
 ASTM C1028 > 0,60
 BCRA W.D. > 0,40
 PTV FOUR 6 W.D. > 0,36



26,5x180
 10^{1/2}"x72"



16x100
 6"x40"

16x100
 6"x40"



BEIGE CHIARO V3



BEIGE SCURO V4



ROVERE CHIARO V3



ROVERE SCURO V4



GRIGIO CHIARO V3



GRIGIO SCURO V3





FLOOR: GRIGIO CHIARO 26,5x180 - GRADONE GRIGIO SCURO 120x4x32 - BATTISCOPA MOLATO 8x100



FLOOR: GRIGIO SCURO 26,5x180



FLOOR: ROVERE SCURO 26,5x180



FLOOR: ROVERE SCURO 26,5x180



FLOOR: BEIGE CHIARO 16x100 OUTDOOR



FLOOR: GRIGIO CHIARO 16x100 OUTDOOR



BEIGE CHIARO



BEIGE SCURO



ROVERE CHIARO



ROVERE SCURO



26,5x180
10¹/₂"x72"



16x100
6"x40"



16x100
6"x40"
OUTDOOR 9 MM





26,5x180
10¹/₂"x72"





16x100
6"x40"



16x100
6"x40"
OUTDOOR 9 MM

	BEIGE CHIARO	51100	51200	51210
	BEIGE SCURO	51102	51202	51212

	ROVERE CHIARO	51101	51201	51211
	ROVERE SCURO	51103	51203	51213



GRIGIO CHIARO



GRIGIO SCURO



26,5x180
10¹/₂"x72"



16x100
6"x40"



16x100
6"x40"
OUTDOOR 9 MM

	GRIGIO CHIARO	51104	51204	51214
	GRIGIO SCURO	51105	51205	51215

MOSAICI E PEZZI SPECIALI

SPECIAL TRIMS . PIECES SPECIALES . SONDERSTÜCKE
PIEZAS ESPECIALES . СПЕЦИАЛЬНЫЕ ИЗДЕЛИЯ . 特别装饰

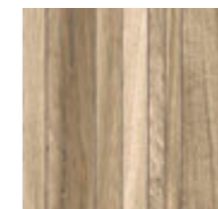

MOSAICO LISTELLATO 26,5x26,5
1.

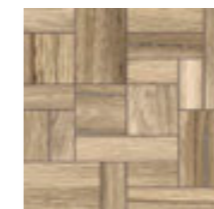

MOSAICO INTRECCIO 26,5x26,5
2.



GRADONE 120x32x4
3.

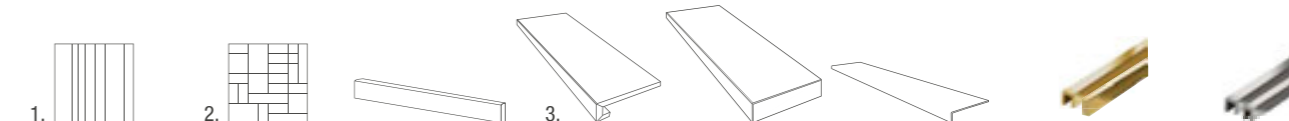

	MOSAICO LISTELLATO 26,5X26,5	MOSAICO INTRECCIO 26,5X26,5	BATTISCOPA MOLATO 8x100	GRADONE 120x32x4	GRADONE ANGOLARE 120x32x4	ELEMENTO "L" 100X32X4	PROFILI OTTONE	PROFILI ACCIAIO	
	BEIGE CHIARO	51180	51190	ML51200	51150	51160 ^{DX} 51170 ^{SX}	51260	119863 ^{1x80} 26231 ^{1x60}	119862 ^{1x80} 26230 ^{1x60}
	BEIGE SCURO	51182	51192	ML51202	51152	51162 ^{DX} 51172 ^{SX}	51262	119861 ^{0,5x80} 26236 ^{0,5x60}	119860 ^{0,5x80} 26235 ^{0,5x60}
	ROVERE CHIARO	51181	51191	ML51201	51151	51161 ^{DX} 51171 ^{SX}	51261		
	ROVERE SCURO	51183	51193	ML51203	51153	51163 ^{DX} 51173 ^{SX}	51263		
	GRIGIO CHIARO	51184	51194	ML51204	51154	51164 ^{DX} 51174 ^{SX}	51264		
	GRIGIO SCURO	51185	51195	ML51205	51155	51165 ^{DX} 51175 ^{SX}	51265		

IMBALLI . PACKING . CONDITIONNEMENT . VERPACKUNGSEINHEITEN . EMBALAJES . УПАКОВКА . 包装

EN 14411/G Bla

FORMATO SIZE	SPESSORE THICKNESS	PZ/SCAT. PCS/BOX	MQ/SCAT. SQM/BOXT	KG/SCAT. KG/BOX	SCAT./PAL BOX/PAL	MQ/PAL SQM/PAL	KG/PAL
26,5x180	9 mm	3	1,431	30,60	42	60,10	1285,20
16x100	9 mm	7	1,120	21,20	64	71,68	1356,80
BATTISCOPA MOLATO 8x100	9 mm	4	4,00 ml	7,36	-	-	-
GRADONE 120x32x4	9 mm	2	-	22,85	-	-	-
GRADONE ANGOLARE 120x32x4	9 mm	1	-	13,00	-	-	-
ELEMENTO "L" 100x32x4	9 mm	2	-	16,00	-	-	-
MOSAICO LISTELLATO 26,5x26,5	9 mm	4	-	6,70	-	-	-
MOSAICO INTRECCIO 26,5x26,5	9 mm	4	-	9,20	-	-	-
PROFILI METALLO 0,5x60 - 1x60	-	6	3,60 ml	2,70	-	-	-
PROFILI METALLO 0,5x80 - 1x80	-	6	4,80 ml	3,00	-	-	-

I DATI RELATIVI A IMBALLAGGI E PESI POSSONO SUBIRE DELLE VARIAZIONI . INFORMATIONS AND DETAILS RELATED TO PACKAGING AND WEIGHT ARE SUBJECT TO CHANGE
LES DONNÉES CONCERNANT EMBALLAGE ET POIDS SONT SUJETTES À VARIATIONS . DIE ANGABEN ÜBER VERPACKUNGEN UND GEWICHTE SIND NICHT BINDEND
LOS DATOS RELACIONADOS CON EL EMBALAJE Y LOS PESOS PUEDEN ESTAR SUJETOS A CAMBIOS . ДАННЫЕ, ОТНОСЯЩИЕСЯ К УПАКОВКЕ И ВЕСУ, ПОДЛЕЖАТ ИЗМЕНЕНИЯМ
与包装和重量有关的数据可能会更改

Slabs

pragetti



- 254 Calacatta Gold
- 257 Calacatta Statuario
- 260 Calacatta Crema
- 261 Antique Brown
- 262 Calacatta Arabesque
- 263 Premium White
- 264 Infinity
- 265 Elegant
- 266 Silver White
- 267 Golden White
- 268 Royal
- 269 Prestige
- 270 Travertino Bianco
- 271 White Carrara Venato
- 272 Tuscany Travertine
- 272 King
- 273 Blue Stone
- 273 Grey Venice
- 274 Sahara Noir
- 275 Marquina Black
- 276 Grey Stone
- 277 Le Tinte Unite
- 271 Blue Stone
- 278 Onyx
- 280 Agate
- 282 Factory
- 283 Basalto
- 284 Avenue
- 285 Ceppo di Gré



le Lastre

Slabs

GRES FINE PORCELLANATO

FINE PORCELAIN STONEWARE
GRÈS CÉRAME FIN
FEINSTEINZEUG
GRES FINO PORCELÁNICO
ТОНКИЙ КЕРАМОГРАНИТ
精细炻瓷

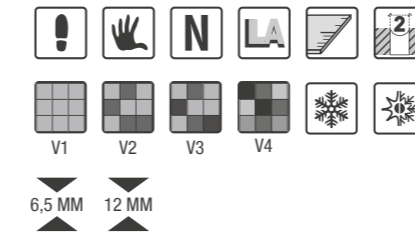

2 SUPERFICI (NATURALE - LAPPATO)
NATURAL SURFACES - SEMI-POLISHED SURFACE
SURFACES NATURELLES - SEMI-POLI
NATÜRLICHE OBERFLÄCHEN - ANPOLIERT OBERFLÄCHE
SUPERFICIES NATURALES - SEMI-PULIDO
НАТУРАЛЬНАЯ ПОВЕРХНОСТЬ - ПОЛУПОЛИРОВАННЫЙ
天然表面 - 抛光



160x320 (RETTIFICATO)
63"x126" (RECTIFIED)
162x324 (NON RETTIFICATO)
64"x128" (NOT RECTIFIED)

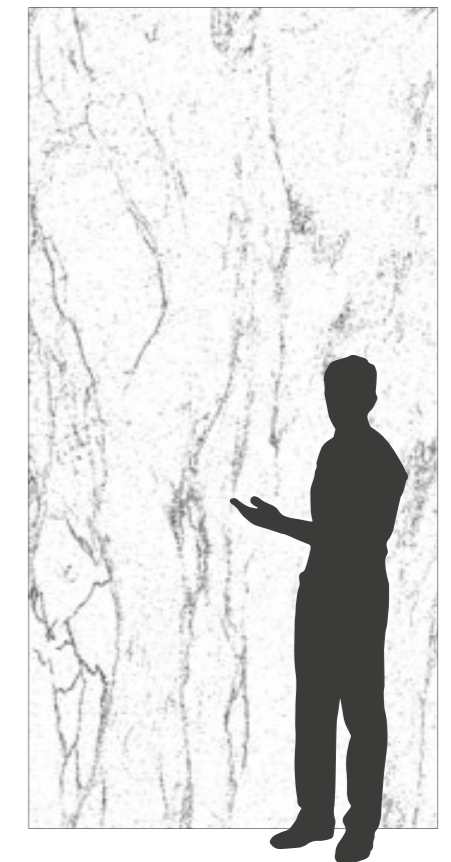



Golden White
Facotry

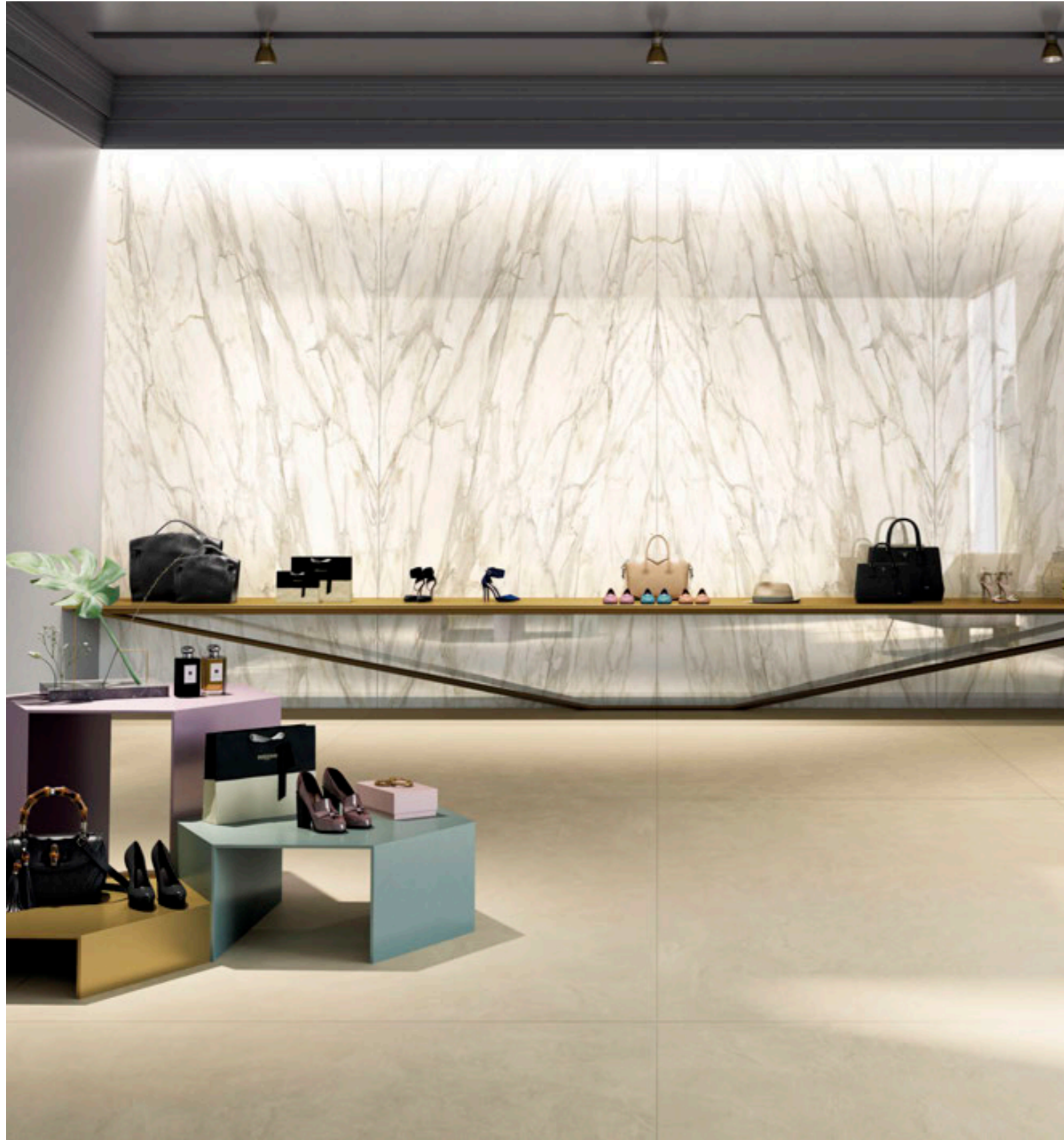

FLOOR: FACTORY ALMOND 160x320
WALL: GOLDEN WHITE 160x320

Calacatta Statuario



FLOOR / WALL: CALACATTA STATUARIO 160x320



CAFE
BISTROT

FLOOR: FACTORY ALMOND 160x320
WALL: FACTORY GRAPHITE - FACTORY ALMOND 160x320

Royal
Basalto



FLOOR: BASALTO NERO 160x320
WALL: ROYAL 160x320



FLOOR: ONYX SAND 160x320
WALL: MARQUINA BLACK 160x320

Calacatta Gold

Slabs



FACE A



FACE B



FACE C



FACE D

		NAT		LAP	
160x320 . 63"x126"	RETTIFICATO	6,5 MM	64070	64075	

		NAT		LAP	
160x320 . 63"x126"	RETTIFICATO	6,5 MM	64071	64076	

		NAT		LAP	
160x320 . 63"x126"	RETTIFICATO	6,5 MM	64072	64077	

		NAT		LAP	
160x320 . 63"x126"	RETTIFICATO	6,5 MM	64073	64078	

Calacatta Gold



FACE BDX



FACE BSX

			NAT	LAP
160x320 . 63"x126"	RETTIFICATO	12 MM	64062	64064
162x324 . 64"x128"	NON RETTIFICATO	12 MM	964062	964064

Calacatta Statuario

Slabs

DISPONIBILE ANCHE 120x240 - SOLO SU ORDINE
AVAILABLE ALSO 120x240 - SPECIAL ORDER ONLY



FACE ASX



FACE ADX

			NAT	LAP
160x320 . 63"x126"	RETTIFICATO	12 MM	64012	64017
162x324 . 64"x128"	NON RETTIFICATO	12 MM	964012	964017

			NAT	LAP
160x320 . 63"x126"	RETTIFICATO	12 MM	64013	64018
162x324 . 64"x128"	NON RETTIFICATO	12 MM	964013	964018

Calacatta Statuario

Slabs

DISPONIBILE ANCHE 120x240 - SOLO SU ORDINE
 AVAILABLE ALSO 120x240 - SPECIAL ORDER ONLY



FACE A



FACE B



FACE C



FACE D

			NAT	LAP
160x320 . 63"x126"	RETTIFICATO	6,5 MM	64020	64025

			NAT	LAP
160x320 . 63"x126"	RETTIFICATO	6,5 MM	64021	64026

			NAT	LAP
160x320 . 63"x126"	RETTIFICATO	6,5 MM	64022	64027

			NAT	LAP
160x320 . 63"x126"	RETTIFICATO	6,5 MM	64023	64028

Calacatta Crema



FACE A



FACE B

			NAT	LAP
160x320 . 63"x126"	RETTIFICATO	12 MM	46460	46462
160x320 . 63"x126"	RETTIFICATO	6,5 MM	46470	46472
162x324 . 64"x128"	NON RETTIFICATO	12 MM	946460	946462

Antique Brown

Slabs



FACE A



FACE B

			NAT	LAP
160x320 . 63"x126"	RETTIFICATO	12 MM	46480	46482
160x320 . 63"x126"	RETTIFICATO	6,5 MM	46490	46492
162x324 . 64"x128"	NON RETTIFICATO	12 MM	946480	946482

			NAT	LAP
160x320 . 63"x126"	RETTIFICATO	12 MM	46481	46483
160x320 . 63"x126"	RETTIFICATO	6,5 MM	46491	46493
162x324 . 64"x128"	NON RETTIFICATO	12 MM	946481	946483

Calacatta Arabesque



FACE A



FACE B

			NAT	LAP
160x320 . 63"x126"	RETTIFICATO	12 MM	64040	64042
160x320 . 63"x126"	RETTIFICATO	6,5 MM	64045	64047
162x324 . 64"x128"	NON RETTIFICATO	12 MM	964040	964042

			NAT	LAP
160x320 . 63"x126"	RETTIFICATO	12 MM	64041	64043
160x320 . 63"x126"	RETTIFICATO	6,5 MM	64046	64048
162x324 . 64"x128"	NON RETTIFICATO	12 MM	964041	964043

Premium White

Slabs



FACE A



FACE B

			NAT	LAP
160x320 . 63"x126"	RETTIFICATO	12 MM	64532	64534
160x320 . 63"x126"	RETTIFICATO	6,5 MM	64552	64554
162x324 . 64"x128"	NON RETTIFICATO	12 MM	964532	964534

			NAT	LAP
160x320 . 63"x126"	RETTIFICATO	12 MM	64533	64535
160x320 . 63"x126"	RETTIFICATO	6,5 MM	64553	64555
162x324 . 64"x128"	NON RETTIFICATO	12 MM	964533	964535

Infinity



FACE A

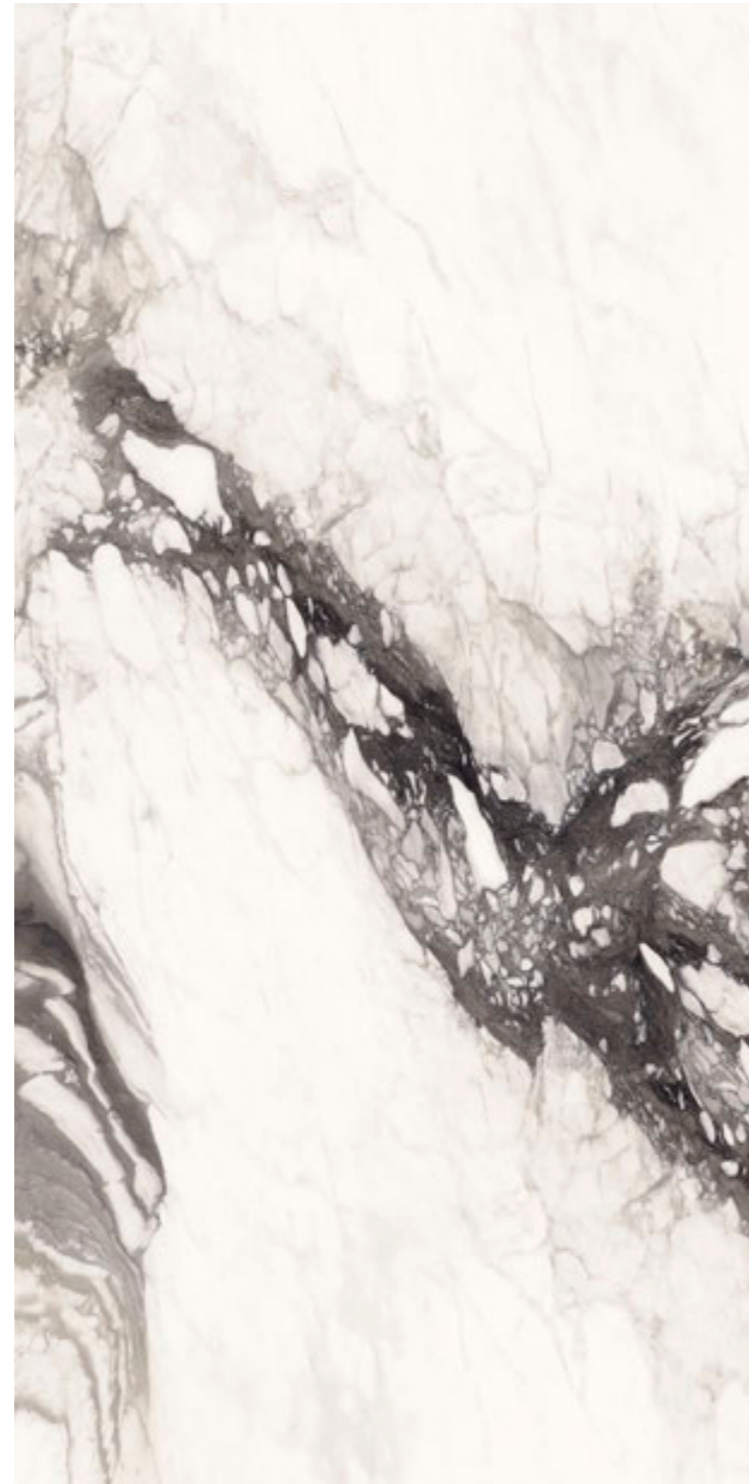

FACE B

			NAT	LAP
160x320 . 63"x126"	RETTIFICATO	12 MM	64340	64342
160x320 . 63"x126"	RETTIFICATO	6,5 MM	64344	64096

Elegant

Slabs

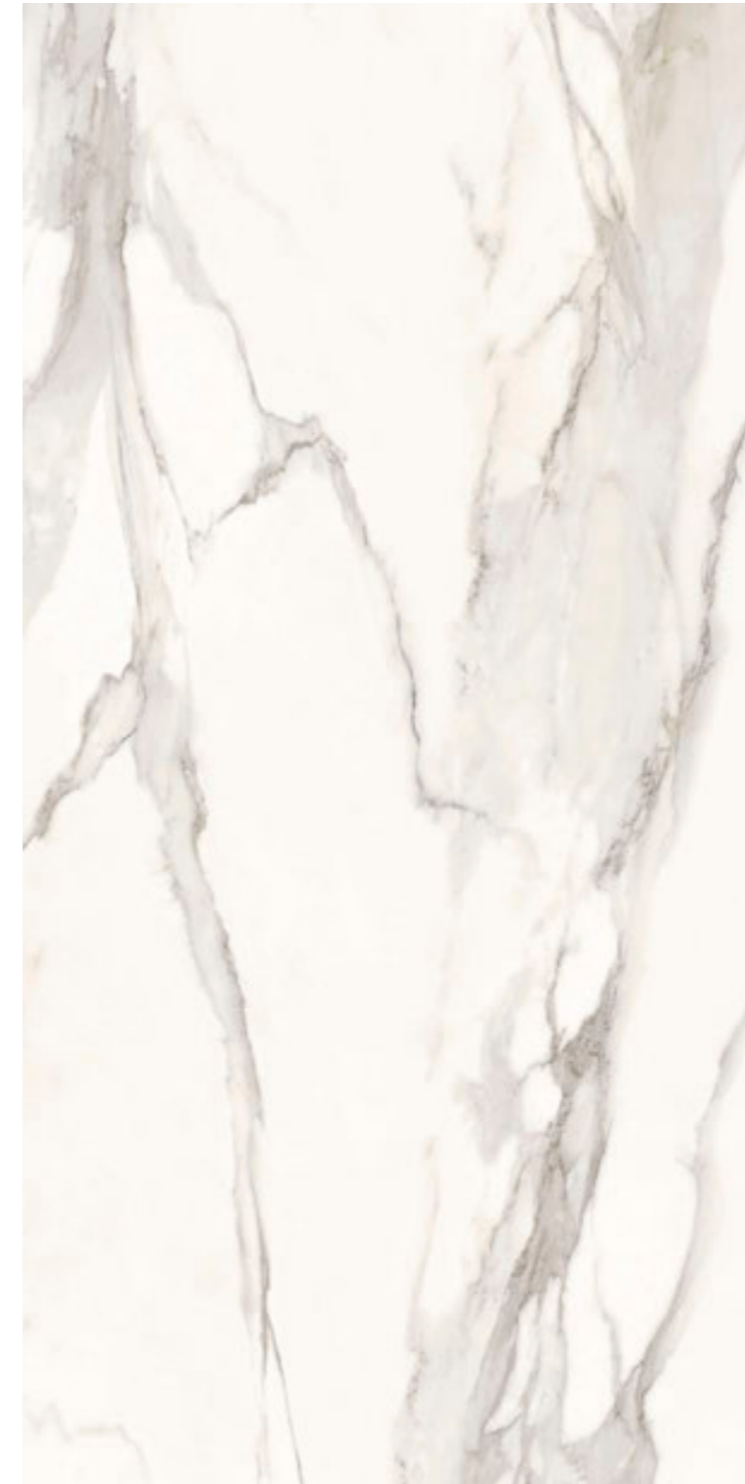

FACE A

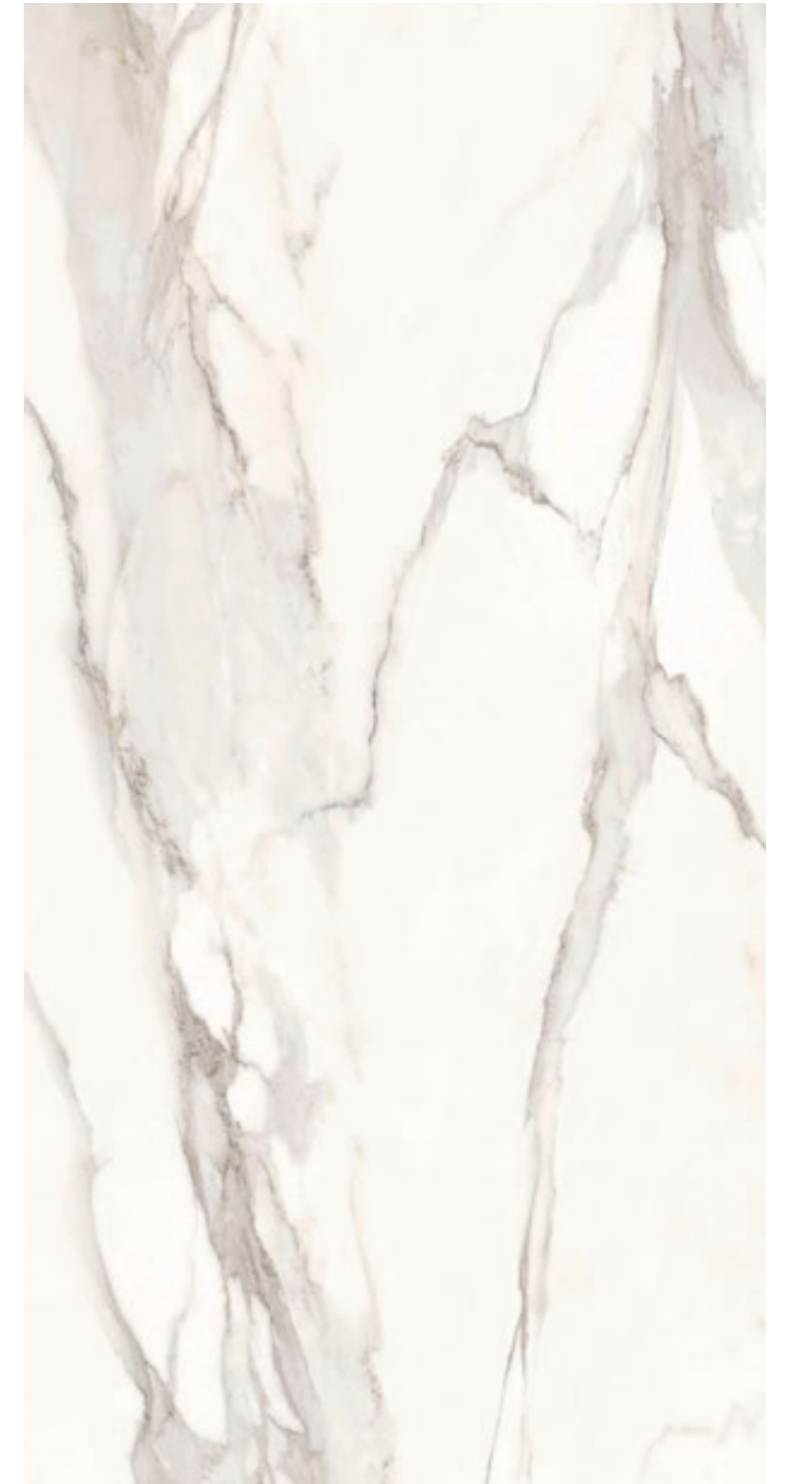

FACE B

			NAT	LAP
160x320 . 63"x126"	RETTIFICATO	12 MM	64330	64332
160x320 . 63"x126"	RETTIFICATO	6,5 MM	64334	64336

			NAT	LAP
160x320 . 63"x126"	RETTIFICATO	12 MM	64331	64333
160x320 . 63"x126"	RETTIFICATO	6,5 MM	64335	64337

Silver White



FACE A



FACE B

			NAT	LAP
160x320 . 63"x126"	RETTIFICATO	12 MM	64350	64352
160x320 . 63"x126"	RETTIFICATO	6,5 MM	64354	64356

Golden White

Slabs



FACE A



FACE B

			NAT	LAP
160x320 . 63"x126"	RETTIFICATO	12 MM	64380	64382
160x320 . 63"x126"	RETTIFICATO	6,5 MM	64384	64386

			NAT	LAP
160x320 . 63"x126"	RETTIFICATO	12 MM	64381	64383
160x320 . 63"x126"	RETTIFICATO	6,5 MM	64385	64387

Royal

DISPONIBILE ANCHE 120x240 - SOLO SU ORDINE
 AVAILABLE ALSO 120x240 - SPECIAL ORDER ONLY



FACE A



FACE B

			NAT	LAP
160x320 . 63"x126"	RETTIFICATO	12 MM	64370	64372
160x320 . 63"x126"	RETTIFICATO	6,5 MM	64374	64376

			NAT	LAP
160x320 . 63"x126"	RETTIFICATO	12 MM	64371	64373
160x320 . 63"x126"	RETTIFICATO	6,5 MM	64375	64377

Prestige

Slabs



FACE A



FACE B

			NAT	LAP
160x320 . 63"x126"	RETTIFICATO	12 MM	64211	64201
160x320 . 63"x126"	RETTIFICATO	6,5 MM	64203	64207

			NAT	LAP
160x320 . 63"x126"	RETTIFICATO	12 MM	64212	64202
160x320 . 63"x126"	RETTIFICATO	6,5 MM	64204	64208

Travertino Bianco



FACE A



FACE B

		NAT		LAP
160x320 . 63"x126"	RETTIFICATO	12 MM	64320	64322
160x320 . 63"x126"	RETTIFICATO	6,5 MM	64324	64326

		NAT		LAP
160x320 . 63"x126"	RETTIFICATO	12 MM	64321	64323
160x320 . 63"x126"	RETTIFICATO	6,5 MM	64325	64327

White Carrara Venato



		NAT		LAP
160x320 . 63"x126"	RETTIFICATO	12 MM	64121	64131
160x320 . 63"x126"	RETTIFICATO	6,5 MM	64141	64151
162x324 . 64"x128"	NON RETTIFICATO	12 MM	964121	964131

Tuscany Travertine

King

Blue Stone

Grey Venice

Slabs

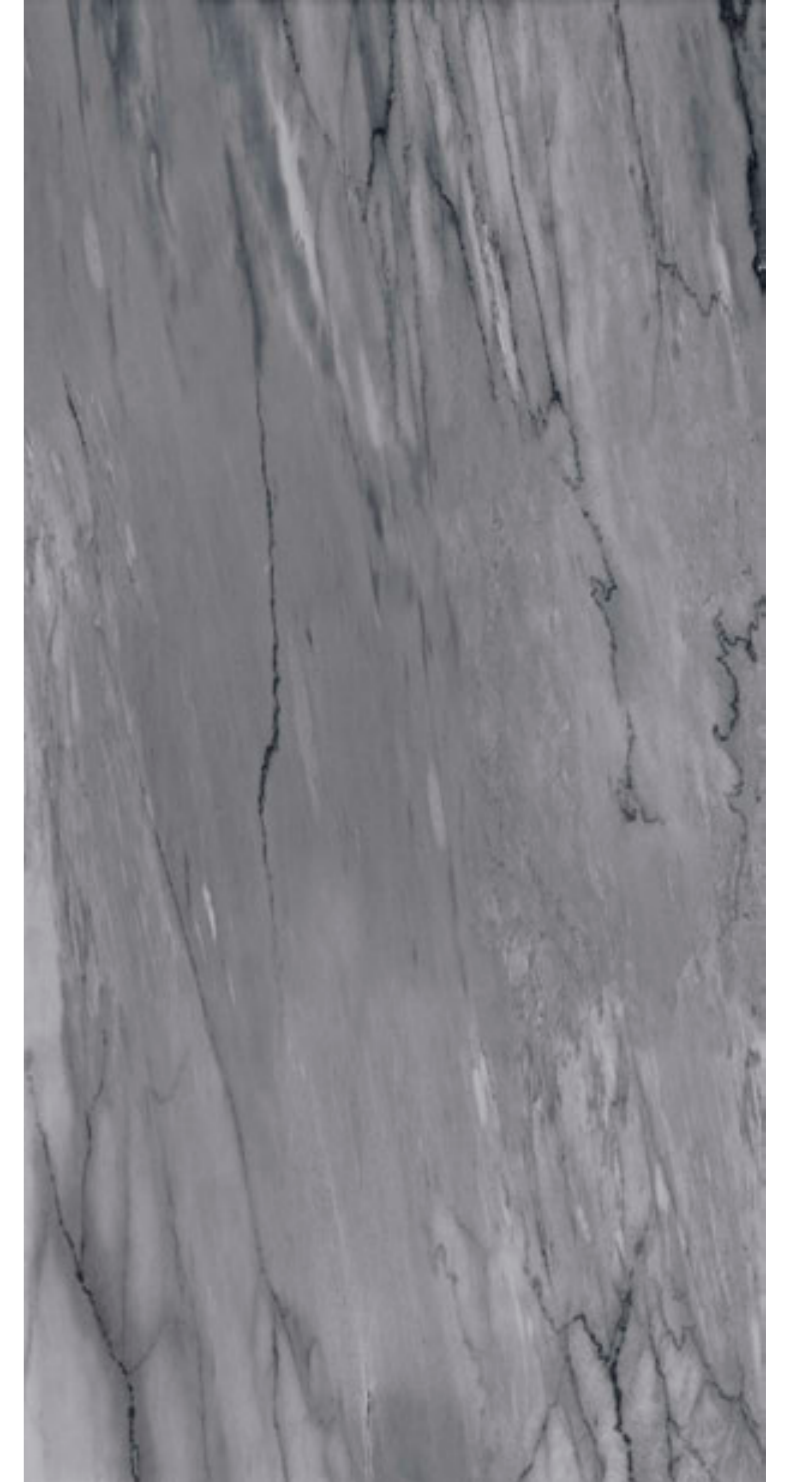

FACE A

		NAT		LAP	
160x320 . 63"x126"	RETTIFICATO	12 MM	64472	64471	
160x320 . 63"x126"	RETTIFICATO	6,5 MM	64482	64483	
162x324 . 64"x128"	NON RETTIFICATO	12 MM	964472	964471	

		NAT		LAP	
160x320 . 63"x126"	RETTIFICATO	12 MM	64530	64536	
160x320 . 63"x126"	RETTIFICATO	6,5 MM	64550	64556	
162x324 . 64"x128"	NON RETTIFICATO	12 MM	964530	964536	

		NAT	
160x320 . 63"x126"	RETTIFICATO	12 MM	64531
160x320 . 63"x126"	RETTIFICATO	6,5 MM	64551
162x324 . 64"x128"	NON RETTIFICATO	12 MM	964531

		NAT		LAP	
160x320 . 63"x126"	RETTIFICATO	12 MM	64453	64451	
162x324 . 64"x128"	NON RETTIFICATO	12 MM	964453	964451	

Sahara Noir



FACE A



FACE B

NAT			
160x320 . 63"x126"	RETTIFICATO	12 MM	64537
162x324 . 64"x128"	NON RETTIFICATO	12 MM	964537

NAT			
160x320 . 63"x126"	RETTIFICATO	12 MM	64538
162x324 . 64"x128"	NON RETTIFICATO	12 MM	964538

Marquina Black

Slabs



FACE A

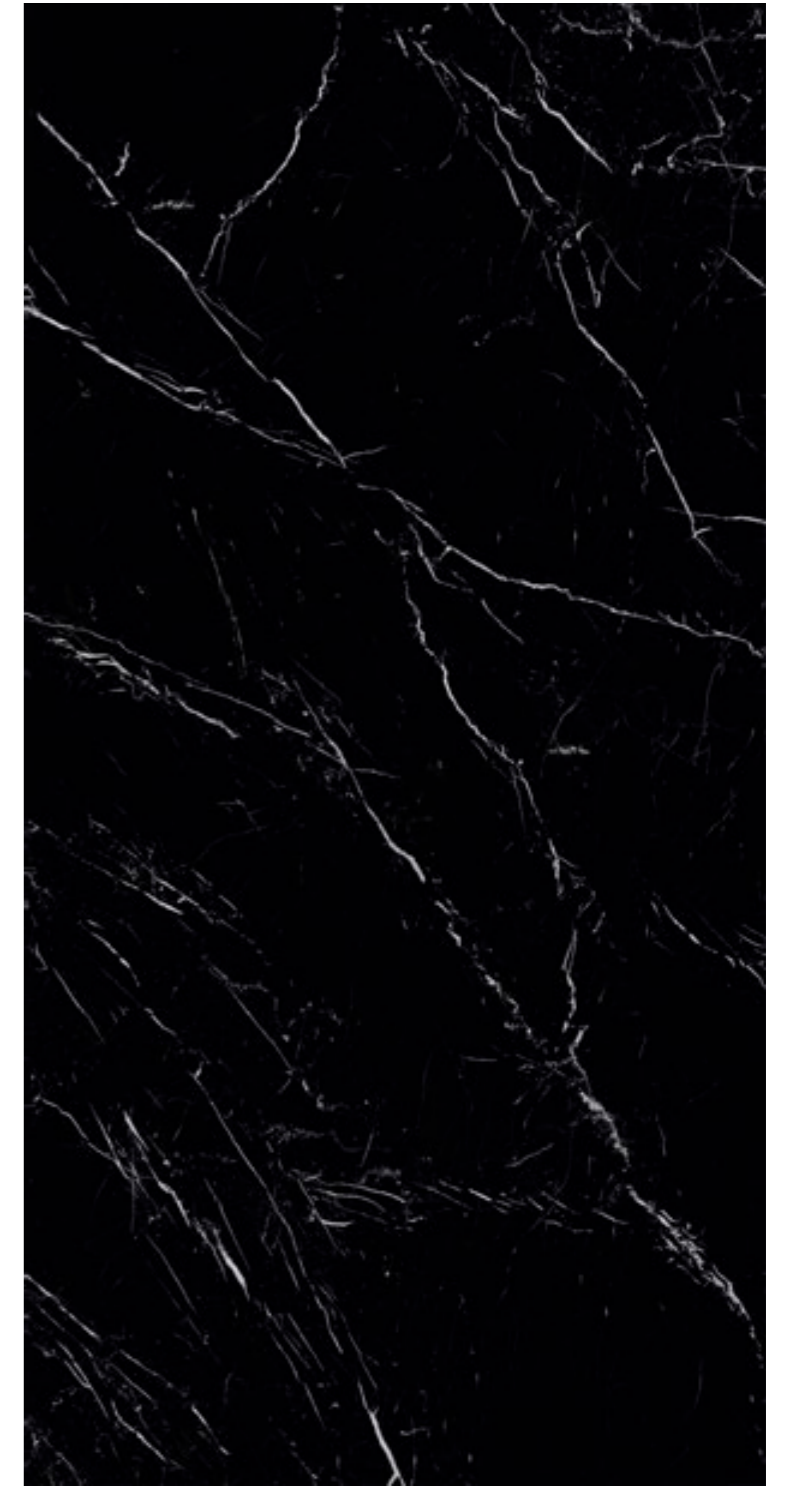

FACE B

		NAT	LAP
160x320 . 63"x126"	RETTIFICATO	12 MM	64109
			64102

		NAT	LAP
160x320 . 63"x126"	RETTIFICATO	12 MM	64119
			64128

Grey Stone



FACE A



FACE B

			NAT	LAP
160x320 . 63"x126"	RETTIFICATO	12 MM	64520	64521
160x320 . 63"x126"	RETTIFICATO	6,5 MM	64522	64523
162x324 . 64"x128"	NON RETTIFICATO	12 MM	964520	964521

			NAT	LAP
160x320 . 63"x126"	RETTIFICATO	12 MM	64463	64103
160x320 . 63"x126"	RETTIFICATO	6,5 MM	64480	64481
162x324 . 64"x128"	NON RETTIFICATO	12 MM	964463	964103

Le Tinte Unite

Slabs

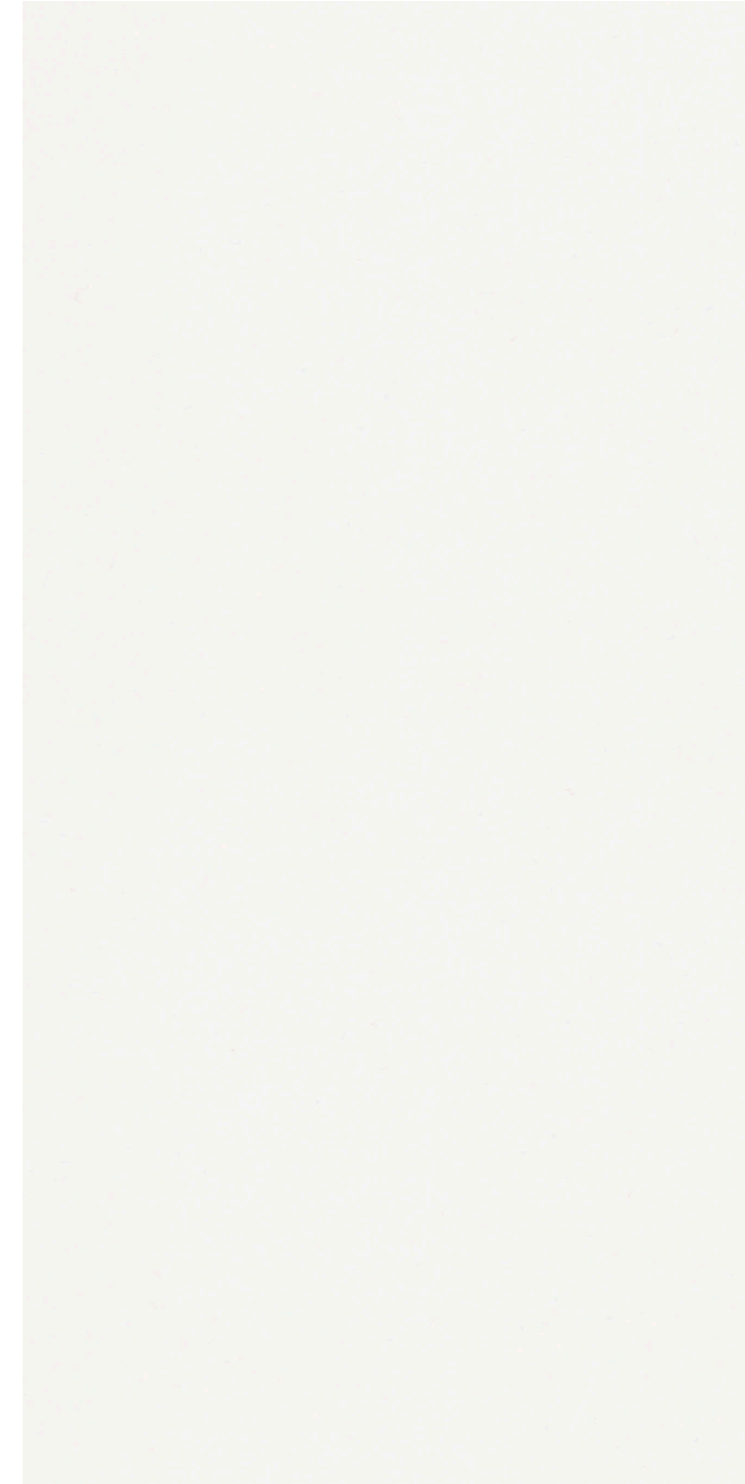

WHITE



BLACK

			NAT	LAP
160x320 . 63"x126"	RETTIFICATO	12 MM	64400	64401
160x320 . 63"x126"	RETTIFICATO	6,5 MM	64402	64403

			NAT
160x320 . 63"x126"	RETTIFICATO	12 MM	64410
160x320 . 63"x126"	RETTIFICATO	6,5 MM	64412



SAND - FACE A



SAND - FACE B



VANILLA

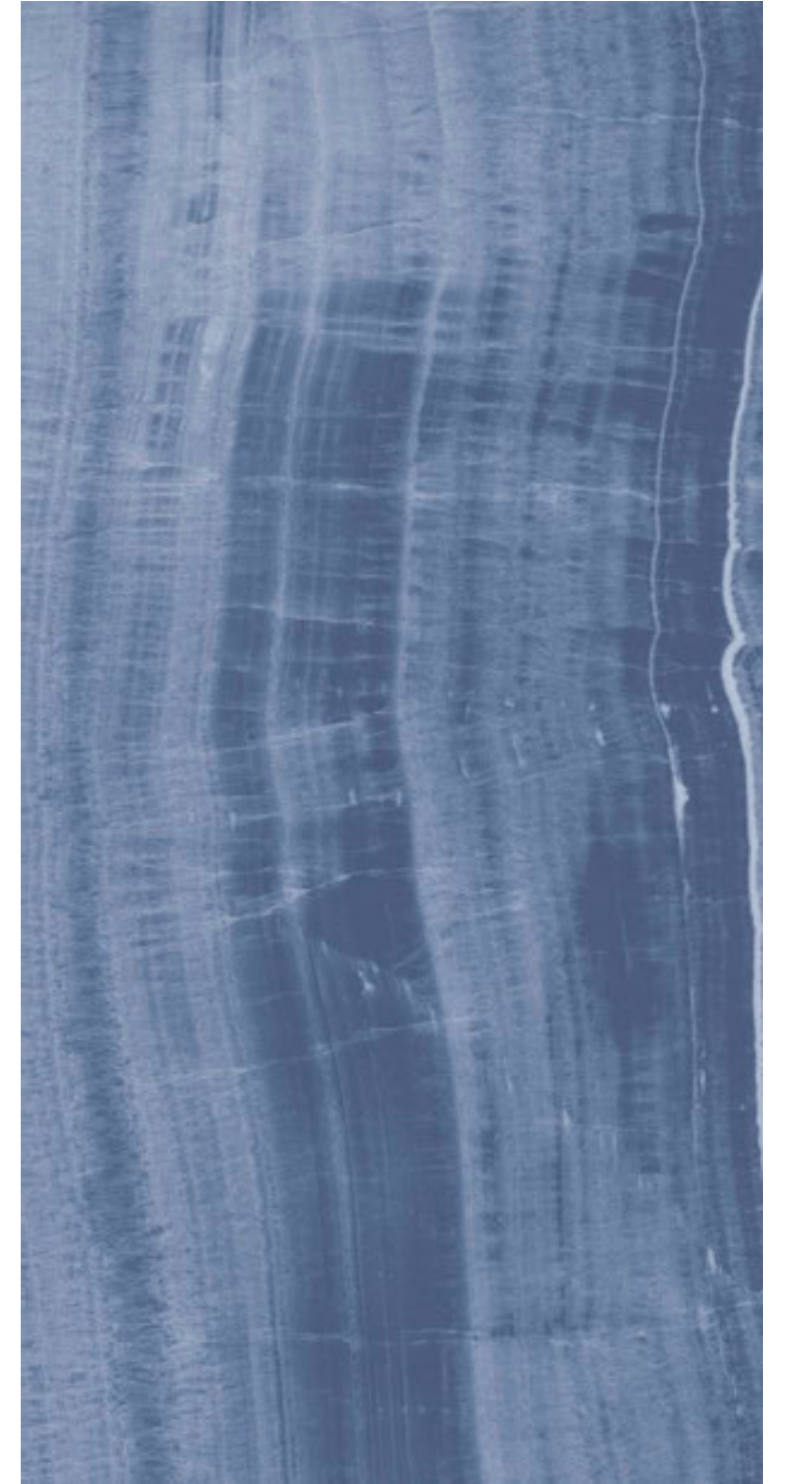

BLU

		NAT		LAP	
160x320 . 63"x126"	RETTIFICATO	12 MM	64310	64312	
160x320 . 63"x126"	RETTIFICATO	6,5 MM	64314	64316	

		NAT		LAP	
160x320 . 63"x126"	RETTIFICATO	12 MM	64311	64313	
160x320 . 63"x126"	RETTIFICATO	6,5 MM	64315	64317	

		LAP		
160x320 . 63"x126"	RETTIFICATO	6,5 MM	64080	

		LAP		
160x320 . 63"x126"	RETTIFICATO	6,5 MM	64082	



BLUE - FACE A



BLUE - FACE B

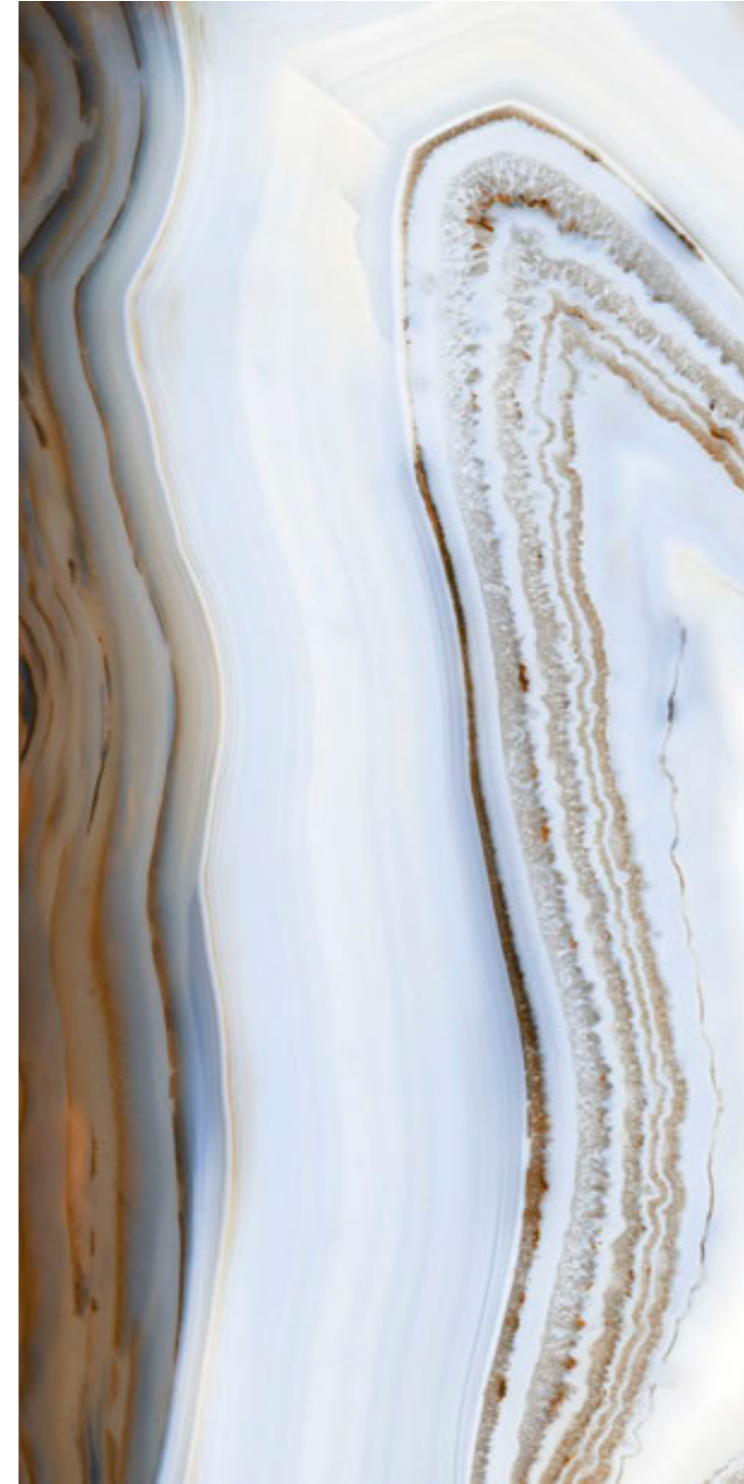

BLEND - FACE A

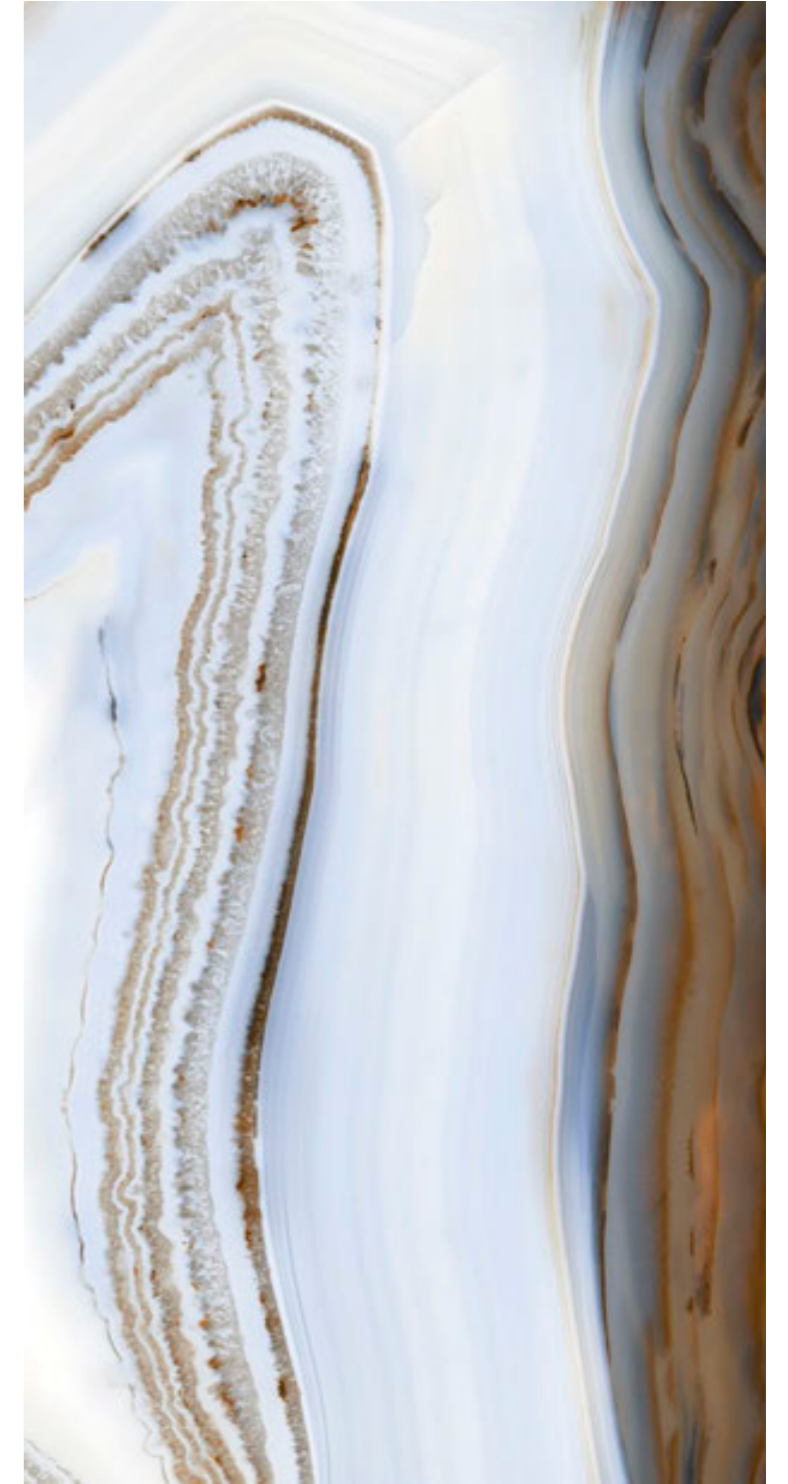

BLEND - FACE B

LAP

160x320 . 63"x126" RETTIFICATO 6,5 MM 64094

LAP

160x320 . 63"x126" RETTIFICATO 6,5 MM 64095

LAP

160x320 . 63"x126" RETTIFICATO 6,5 MM 64090

LAP

160x320 . 63"x126" RETTIFICATO 6,5 MM 64091

Factory

Basalto

Slabs



IRON

GRAPHITE

GRIGIO

NERO

		NAT	
160x320 . 63"x126"	RETTIFICATO	12 MM	64301
162x324 . 64"x128"	NON RETTIFICATO	12 MM	964301

		NAT	
160x320 . 63"x126"	RETTIFICATO	12 MM	64302
162x324 . 64"x128"	NON RETTIFICATO	12 MM	964302

		NAT	
160x320 . 63"x126"	RETTIFICATO	12 MM	64422
160x320 . 63"x126"	RETTIFICATO	6,5 MM	64420

		NAT	
160x320 . 63"x126"	RETTIFICATO	12 MM	64423
160x320 . 63"x126"	RETTIFICATO	6,5 MM	64421

Avenue



WHITE

NAT			
160x320 . 63"x126"	RETTIFICATO	12 MM	64566
160x320 . 63"x126"	RETTIFICATO	6,5 MM	64546
162x324 . 64"x128"	NON RETTIFICATO	12 MM	964566



GREY

NAT			
160x320 . 63"x126"	RETTIFICATO	12 MM	64567
160x320 . 63"x126"	RETTIFICATO	6,5 MM	64547
162x324 . 64"x128"	NON RETTIFICATO	12 MM	964567



ANTRACITE

NAT			
160x320 . 63"x126"	RETTIFICATO	12 MM	64568
160x320 . 63"x126"	RETTIFICATO	6,5 MM	64548
162x324 . 64"x128"	NON RETTIFICATO	12 MM	964568

Ceppo di Gré

Slabs



NAT			
160x320 . 63"x126"	RETTIFICATO	12 MM	64569
160x320 . 63"x126"	RETTIFICATO	6,5 MM	64549
162x324 . 64"x128"	NON RETTIFICATO	12 MM	964569

Slabs

IMBALLI . PACKING . CONDITIONNEMENT . VERPACKUNGSEINHEITEN . EMBALAJES . УПАКОВКА . 包裝



CASSA - CRATE					EN 14411/G Bla			
LASTRA SLAB	SPESSORE THICKNESS	FORMATO CASSA CRATE SIZE	330X170X37 CM 130"X67"X15"	PESO CASSA VUOTA 140 KG EMPTY CRATE WEIGHT	NUMERO CASSE SOVRAPPONIBILI PER STOCCAGGIO MAGAZZINO 10 OVERLAP CRATES FOR WAREHOUSE STORAGE			
		MQ - LASTRA SQM - SLAB	KG - LASTRA KG - SLAB	LASTRE - CASSA SLABS - CRATE	MQ - CASSA SQM - CRATE	KG - CASSA KG - CRATE	CASSE - CONT. 20' CRATE - CONT. 20'	MQ - CONT. 20' SQM - CONT. 20'
160x320	6,5 mm	5,12	82	15	76,80	1.230	5	384,00
160x320	12 mm	5,12	145	9	46,08	1.305	5	230,40
162x324	12 mm NON RECTIFIED LAP	5,248	148	9	47,25	1.332	5	263,20
162x324	12 mm NON RECTIFIED NAT	5,25	148	10	52,50	1.480	5	262,50



CAVALLETTO - A-FRAME					EN 14411/G Bla			
LASTRA SLAB	SPESSORE THICKNESS	FORMATO CAVALLETTO A-FRAME SIZE	330x75x200 CM 130"X30"X79"	PESO CAVALLETTO VUOTO 260 KG EMPTY A-FRAME WEIGHT				
		MQ - LASTRA SQM - SLAB	KG - LASTRA KG - SLAB	LASTRE - CAV. SLABS - A-FRAME	MQ - CAV. SQM - A-FRAME	KG - CAV. KG - A-FRAME	CAV. - CONT. 20' A-FRAME - CONT. 20'	MQ - CONT. 20' SQM - CONT. 20'
160x320	6,5 mm	5,12	82	50	256	4.100	3	768,00
160x320	12 mm	5,12	145	24	122,88	3.480	3	368,64
162x324	12 mm NON RECTIFIED	5,248	148	24	125,95	3.552	3	377,85



FLOOR: CALACATTA STATUARIO 160x320



Outdoor

20MM - 9MM

pragetti

- Amboise
- Burlington Stone
- Concept Stone
- Origini
- D.Sign
- Make
- Mood
- Native
- Just Life
- Just Code
- Just Mix
- Just Nature
- Just Venice



Outdoor

20MM - 9MM

GRES FINE PORCELLANATO AD IMPASTO COLORATO
 COLORBODY FINE PORCELAIN STONEWARE
 GRES CÉRAME TEINTÉ DANS LA MASSE
 FEINSGEINZEUG MIT EINGEFÄRBTEN SCHERBEN
 GRES PORCELÁNICO MASA COLOREADA
 ОКРАШЕННЫЙ ПО ВСЕ ТОЛЩИНЕ КЕРАМОГРАНИТ
 彩色坯体瓷质玻化上釉砖

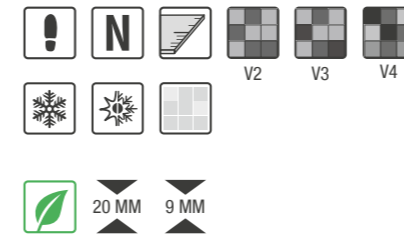

TECNOLOGIA AD ALTA DEFINIZIONE
HIGH-DEFINITION TECHNOLOGY

1 SUPERFICIE (NATURALE)
 NATURAL SURFACE
 SURFACE NATURELLE
 NATÜRLICHE OBERFLÄCHE
 SUPERFICIE NATURAL
 НАТУРАЛЬНАЯ ПОВЕРХНОСТЬ
 天然表面



R11

R11 GRUPPO B (OUTDOOR)
 DCOF > 0,42
 ASTM C1028 > 0,60
 BCRA W.D. > 0,40
 PTV FOUR 6 W.D. > 0,36



30x120 12"x48"
Outdoor
20 MM

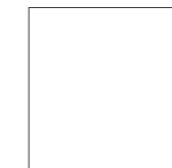

80x80 32"x32"
Outdoor
20 MM-9 MM



100x100 40"x40"
Outdoor
9 MM



16x100 6"x40"
Outdoor
9 MM

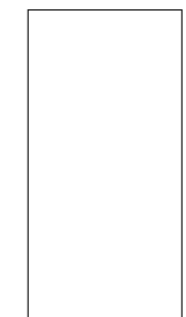

60x120 24"x48"
Outdoor
9 MM



20x120 8"x48"
Outdoor
9 MM



40x80 16"x32"
Outdoor
9 MM



FLOOR CONCEPT STONE: GRIGIO 80x80 OUTDOOR 20MM - TEXTURE GRIGIO 80x80 OUTDOOR 20MM



FLOOR CONCEPT STONE: GRIGIO 80x80 OUTDOOR 20MM - GRADONE TORELLO 4x32x80 OUTDOOR 20MM

Outdoor
20MM - 9MM



FLOOR NATIVE: SILVER 80x80 OUTDOOR 20MM - GRADONE TORELLO 20MM 80x32 - GRADONE 80x32x4



Outdoor
20MM - 9MM



AMBOISE: FANGO OUTDOOR 80x80 20MM

Outdoor
20MM - 9MM



AMBOISE: CALCE OUTDOOR 80x80 R11



FLOOR MOOD: CLAY 80x80 OUTDOOR 9MM
ASH GRADONE E ANGOLARE







FLOOR JUST VENICE: GRIGIO CHIARO 16x100 OUTDOOR 9MM



FLOOR JUST LIFE: BEIGE CHIARO 16x100 OUTDOOR 9MM



Amboise

80x80 32"x32" - 20 MM - 9 MM
100x100 40"x40" - 9MM

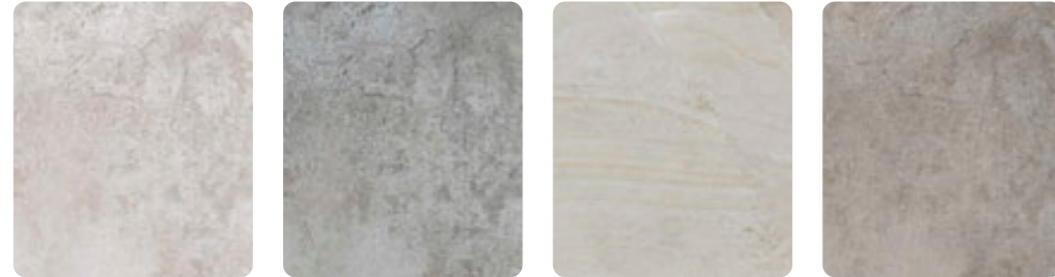

CALCE	CEMENTO	POLVERE	FANGO
20MM 74603 - 80x80 32"x32"	20MM 74602 - 80x80 32"x32"	20MM 74600 - 80x80 32"x32"	20MM 74601 - 80x80 32"x32"
9MM 74743 - 100x100 40"x40" 74593 - 80x80 32"x32"	9MM 74742 - 100x100 40"x40" 74592 - 80x80 32"x32"	9MM 74740 - 100x100 40"x40" 74590 - 80x80 32"x32"	9MM 74741 - 100x100 40"x40" 74591 - 80x80 32"x32"

Origini

80x80 32"x32" - 20 MM - 9 MM



AGE STONE	GRIS ROYAL	CRUX WHITE	CRUX GREY	BOLGHERI
20MM 73550 - 80x80 32"x32"	20MM 73554 - 80x80 32"x32"	9MM 73702 - 80x80 32"x32"	9MM 73701 - 80x80 32"x32"	9MM 73703 - 80x80 32"x32"
	9MM 73704 - 80x80 32"x32"			

Concept Stone

80x80 32"x32" - 20 MM - 9 MM
40x80 16"x32" - 9MM

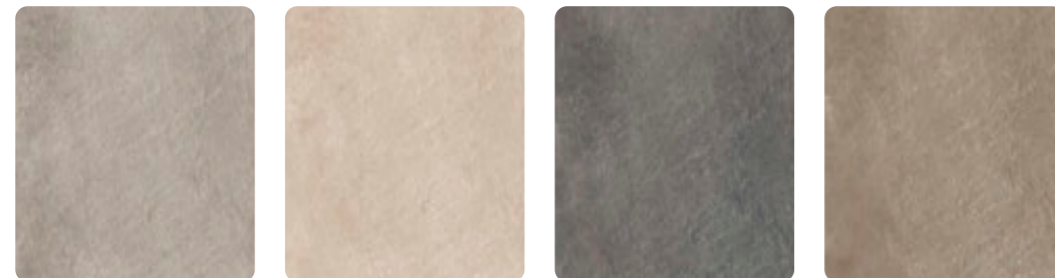
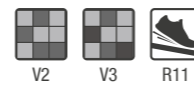

GRIGIO	SABBIA	ANTRACITE	BRUNO MEDIO
20MM 54123 - 80x80 32"x32"	20MM 54122 - 80x80 32"x32"	20MM 54125 - 80x80 32"x32"	20MM 54124 - 80x80 32"x32"
9MM 54463 - 80x80 32"x32" 54473 - 40x80 16"x32"	9MM 54462 - 80x80 32"x32" 54472 - 40x80 16"x32"	9MM 54465 - 80x80 32"x32" 54475 - 40x80 16"x32"	9MM 54464 - 80x80 32"x32" 54474 - 40x80 16"x32"



GRIGIO DECORATO (MIX 3 SOGGETTI) 54133	SABBIA DECORATO (MIX 3 SOGGETTI) 54132	ANTRACITE DECORATO (MIX 3 SOGGETTI) 54135	BRUNO MEDIO DECORATO (MIX 3 SOGGETTI) 54134
---	---	--	--

D.Sign

80x80 32"x32" - 20 MM - 9 MM

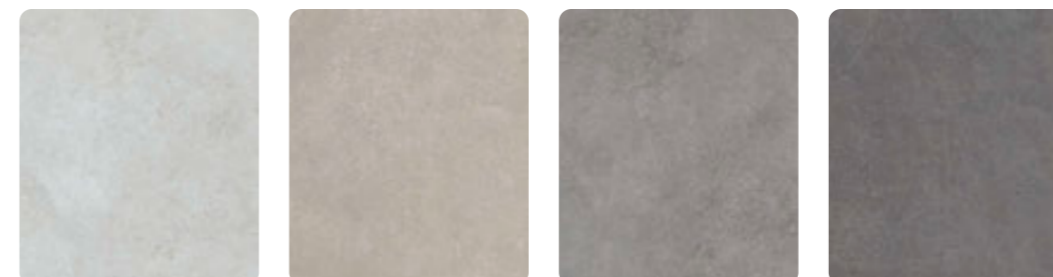

WHITE	SAND	GREY	ANTRACITE
20MM 74100 - 80x80 32"x32"	20MM 74101 - 80x80 32"x32"	20MM 74102 - 80x80 32"x32"	20MM 74103 - 80x80 32"x32"
9MM 74090 - 80x80 32"x32"	9MM 74091 - 80x80 32"x32"	9MM 74092 - 80x80 32"x32"	9MM 74093 - 80x80 32"x32"



Make

80x80 32"x32" - 20 MM - 9 MM



ASH V3
20MM
53052 - 80x80 32"x32"
9MM
73102 - 80x80 32"x32"

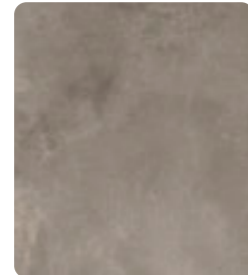

GRIGIO CORTEN V3
20MM
73055 - 80x80 32"x32"
9MM
73105 - 80x80 32"x32"

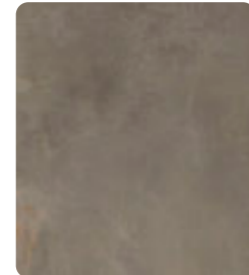

ANTRACITE CORTEN V4
20MM
73054 - 80x80 32"x32"
9MM
73104 - 80x80 32"x32"



NERO CORTEN V4
20MM
73053 - 80x80 32"x32"



CORDA V3
9MM
73101 - 80x80 32"x32"

Native

80x80 32"x32" - 20 MM - 9 MM



SAND
20MM
56790 - 80x80 32"x32"
9MM
56690 - 80x80 32"x32"

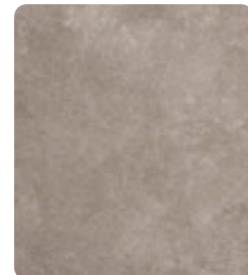

MUD
20MM
56792 - 80x80 32"x32"
9MM
56692 - 80x80 32"x32"



SILVER
20MM
56791 - 80x80 32"x32"
9MM
56691 - 80x80 32"x32"



CONCRETE
20MM
56793 - 80x80 32"x32"
9MM
56693 - 80x80 32"x32"

Just Code

30x120 12"x48" - 20 MM
20x120 8"x48" - 9MM



MIELE
20MM
75115 - 30x120 12"x48"
9MM
75095 - 20x120 8"x48"



GREIGE
20MM
75114 - 30x120 12"x48"
9MM
75094 - 20x120 8"x48"

Just Mix

30x120 12"x48" - 20 MM
20x120 8"x48" - 9MM



BIANCO
20MM
75520 - 30x120 12"x48"
9MM
75610 - 20x120 8"x48"



GRIGIO
20MM
75522 - 30x120 12"x48"
9MM
75612 - 20x120 8"x48"



MIELE
20MM
75521 - 30x120 12"x48"
9MM
75611 - 20x120 8"x48"



BROWN
20MM
75523 - 30x120 12"x48"
9MM
75613 - 20x120 8"x48"



Burlington Stone
60x120 24"x48" - 9 MM

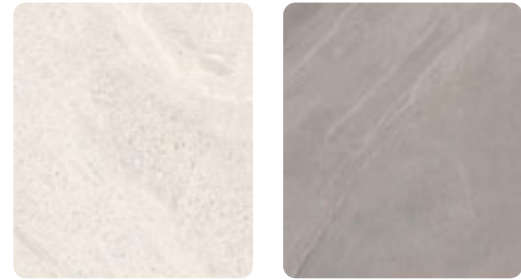

PEARL
55440

ROCK
55442

Make
80x80 32"x32" - 9 MM

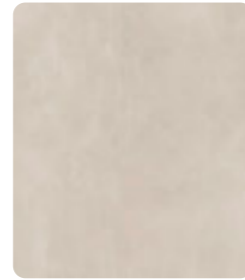
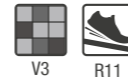

CORDA
73101

Just Life
16x100 6"x40" - 9 MM



BEIGE BIONDO
50135

BEIGE SCURO
50136

NOCE ROSSO
50137

GRIGIO
50131

MUSCHIO
50134

Origini
80x80 32"x32" - 9 MM

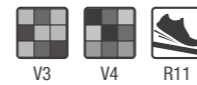

CRUX WHITE
73702

V3

CRUX GREY
73701

V4

GRIS ROYAL
73704

V3

BOLGHERI
73703

V3

Just Nature
20x120 8"x48" - 9 MM



BEIGE MEDIO
52136

BEIGE SCURO
52133

NOCE SCURO
52135

GRIGIO
52130

SBIANCATO
52131

Mood
80x80 32"x32" - 9 MM



SALT
54890

CLAY
54893

CANVAS
54891

TAN
54892

RUST
54894

ASH
54895

Just Venice
16x100 6"x40" - 9 MM



BEIGE CHIARO
51210

BEIGE SCURO
51212

ROVERE CHIARO
51211

ROVERE SCURO
51213

GRIGIO CHIARO
51214

GRIGIO SCURO
51215

MOSAICI E PEZZI SPECIALI

SPECIAL TRIMS . PIÈCES SPECIALES . SONDERSTÜCKE
PIEZAS ESPECIALES . СПЕЦИАЛЬНЫЕ ИЗДЕЛИЯ . 特别装饰

OUTDOOR 20MM

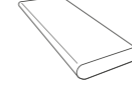
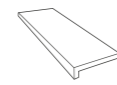

	ELEMENTO AD "L"			GRADONE BORDO ARROTONDATO	
	80x32x4	100x32x4	120x32x4	80x40	120x30
Amboise	CALCE	-	-	74703	-
	CEMENTO	-	-	74702	-
	POLVERE	-	-	74700	-
	FANGO	-	-	74701	-
D.sign	WHITE	74260	-	74210	-
	SAND	74261	-	74211	-
	GREY	-	-	74212	-
	ANTRACITE	-	-	74213	-
Concept Stone	GRIGIO	-	-	53903	-
	ANTRACITE	-	-	53905	-
	SABBIA	-	-	53902	-
	BRUNO MEDIO	-	-	53904	-
Native	SAND	-	-	55680	-
	MUD	-	-	55682	-
	SIVER	-	-	55681	-
	CONCRETE	-	-	55683	-
Make	CORDA	-	-	-	-
	ASH	73232	-	73322	-
	NERO CORTEN	73233	-	73323	-
	ANTRACITE CORTEN	73234	-	73324	-
	GRIGIO CORTEN	73235	-	73325	-
Origini	GRIS ROYAL	73764	-	73864	-
	AGE STONE	73760	-	73860	-
	CRUX WHITE	-	-	-	-
	CRUX GREY	-	-	-	-
	BOLGHERI	-	-	-	-
Just Code	MIELE	-	75125	-	75145
	GREIGE	-	75124	-	75144
Just Mix	BIANCO	-	75630	-	75650
	GRIGIO	-	75632	-	75652
	MIELE	-	75631	-	75651
	BROWN	-	75633	-	75653
Burlington Stone	PEARL	-	-	-	-
	ROCK	-	-	-	-
Mood	SALT	-	-	-	-
	CLAY	-	-	-	-
	ASH	-	-	-	-
	CANVAS	-	-	-	-
	TAN	-	-	-	-
Just Life	RUST	-	-	-	-
	BEIGE BIONDO	-	-	-	-
	BEIGE SCURO	-	-	-	-
	BEIGE MUSCHIO	-	-	-	-
	NOCE ROSSO	-	-	-	-
GRIGIO	-	-	-	-	

DISPONIBILI SU RICHIESTA ULTERIORI PEZZI SPECIALI . ADDITIONAL SPECIAL PIECES AVAILABLE ON REQUEST
PIÈCES SPÉCIALES SUPPLÉMENTAIRES SUR COMMANDE . WEITERE SONDERTEILE AUF ANFRAGE MÖGLICH
DISPONIBLES BAJO PEDIDO OTRAS PIEZAS ESPECIALES . ДРУГИЕ СПЕЦИАЛЬНЫЕ ТОВАРЫ ДОСТУПНЫ ПО ЗАПРОСУ . 可根据要求提供其他特殊件

OUTDOOR 9MM

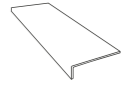

	GRADONE BECCO CIVETTA		ANGOLARE BORDO ARROTONDATO (KIT DX/SX)		ANGOLARE BECCO CIVETTA (KIT DX/SX)		ELEMENTO AD "L"		
	80x40	120x30	160x40	240x30	160x40	240x30	80x32x4	100x32x4	120x32x4
Amboise	74713	-	74723	-	74733	-	74673	74753	-
	74712	-	74722	-	74732	-	74672	74752	-
	74710	-	74720	-	74730	-	74670	74750	-
	74711	-	74721	-	74731	-	74671	74751	-
	74220	-	74230	-	74240	-	74180	-	-
	74221	-	74231	-	74241	-	74181	-	-
	74222	-	74232	-	74242	-	74182	-	-
	74223	-	74233	-	74243	-	74183	-	-
	53913	-	53923	-	53933	-	-	-	-
	53915	-	53925	-	53935	-	-	-	-
D.sign	53912	-	53922	-	53932	-	-	-	-
	53914	-	53924	-	53934	-	-	-	-
	55610	-	55620	-	55630	-	56760	-	-
	55612	-	55622	-	55632	-	56762	-	-
	55611	-	55621	-	55631	-	56761	-	-
	55613	-	55623	-	55633	-	56763	-	-
	-	-	-	-	-	-	73141	-	-
	73332	-	73342	-	73352	-	73142	-	-
	73333	-	73343	-	73353	-	-	-	-
	73334	-	73344	-	73354	-	73144	-	-
Concept Stone	73335	-	73345	-	73355	-	73145	-	-
	73874	-	73884	-	73894	-	73744	-	-
	73870	-	73880	-	73890	-	-	-	-
	-	-	-	-	-	-	73742	-	-
	-	-	-	-	-	-	73741	-	-
	-	-	-	-	-	-	73743	-	-
	-	75155	-	75165	-	75175	-	-	75105
	-	75154	-	75164	-	75174	-	-	75104
	-	75660	-	75670	-	75530	-	-	75620
	-	75662	-	75672	-	75532	-	-	75622
Native	-	75661	-	75671	-	75531	-	-	75621
	-	75663	-	75673	-	75533	-	-	75623
	-	-	-	-	-	-	-	-	55490
	-	-	-	-	-	-	-	-	55492
	-	-	-	-	-	-	55180	-	-
	-	-	-	-	-	-	55183	-	-
	-	-	-	-	-	-	55185	-	-
	-	-	-	-	-	-	55181	-	-
	-	-	-	-	-	-	55182	-	-
	-	-	-	-	-	-	55184	-	-
Make	-	-	-	-	-	-	-	-	-
	-	-	-	-	-	-	-	50186	-
	-	-	-	-	-	-	-	50184	-
	-	-	-	-	-	-	-	50187	-
	-	-	-	-	-	-	-	50181	-

Outdoor

20MM - 9MM

Outdoor
20MM - 9MM

IMBALLI . PACKING . CONDITIONNEMENT . VERPACKUNGSEINHEITEN . EMBALAJES . УПАКОВКА . 包裝

EN 14411/G Bla UGL

FORMATO SIZE	PZ/SCAT. PCS/BOX	MQ/SCAT. SQM/BOXT	KG/SCAT. KG/BOX	SCAT./PAL BOX/PAL	MQ/PAL SQM/PAL	KG/PAL
20 MM						
80X80 - 20MM	1	0,640	28,75	45	28,80	1293,75
ELEMENTO L 80X32X4 20MM	2	1,60 ml	20,00	-	-	-
GRADONE BORDO ARROTONDATO 40X80 20MM	2	1,60 ml	29,00	-	-	-
GRADONE BECCO DI CIVETTA 40X80 20MM	2	1,60 ml	29,00	-	-	-
ANGOLARE BORDO ARROTONDATO 40X160 20MM	1	-	25,00	-	-	-
ANGOLARE BECCO DI CIVETTA 40X160 20MM	1	-	25,00	-	-	-
FONDO 30X120 - 20MM	2	0,720	30,84	36	25,92	1110,24
ELEMENTO L 120X30X4 20MM	2	2,40 ml	32,00	-	-	-
GRADONE BORDO ARROTONDATO 120X30 20MM	2	2,40 ml	32,00	-	-	-
GRADONE BECCO DI CIVETTA 120X30 20MM	2	1,20 ml	32,00	-	-	-
ANGOLARE BORDO ARROTONDATO 240X30 20MM	1	-	-32,00	-	-	-
ANGOLARE BECCO DI CIVETTA 240X30 20MM	1	-	-32,00	-	-	-

FORMATO SIZE	PZ/SCAT. PCS/BOX	MQ/SCAT. SQM/BOXT	KG/SCAT. KG/BOX	SCAT./PAL BOX/PAL	MQ/PAL SQM/PAL	KG/PAL
9 MM						
80X80	2	1,280	24,50	40	51,20	980,00
40X80	4	1,280	25,20	27	34,56	690,61
60X120	2	1,440	29,52	26	37,44	767,52
16x100	7	1,120	21,20	74	71,68	1356,80
20x120	5	1,200	24,16	48	57,60	1159,68
ELEMENTO L 80X32X4	2	1,60 ml	14,00	-	-	-
ELEMENTO L 100X32X4	2	2,00 ml	16,00	-	-	-
ELEMENTO L 12X32X4	2	2,40 ml	18,00	-	-	-

I DATI RELATIVI A IMBALLAGGI E PESI POSSONO SUBIRE DELLE VARIAZIONI . INFORMATIONS AND DETAILS RELATED TO PACKAGING AND WEIGHT ARE SUBJECT TO CHANGE
 LES DONNÉES CONCERNANT EMBALLAGE ET POIDS SONT SUJETTES À VARIATIONS . DIE ANGABEN ÜBER VERPACKUNGEN UND GEWICHTE SIND NICHT BINDEND
 LOS DATOS RELACIONADOS CON EL EMBALAJE Y LOS PESOS PUEDEN ESTAR SUJETOS A CAMBIOS . ДАННЫЕ, ОТНОСЯЩИЕСЯ К УПАКОВКЕ И ВЕСУ, ПОДЛЕЖАТ ИЗМЕНЕНИЯМ
 与包装和重量有关的数据可能会更改



JUST MIX: MIELE 20X120 OUTDOOR 9MM

Pavimenti per esterno

soluzioni di posa

OUTDOOR LAYING SOLUTIONS . POSSIBILITÉS DE MONTAGE POUR SOL D'EXTÉRIEUR .
 VERLEGESYSTEME FÜR TERRASSENPLATTEN . SOLUCIONES DE COLOCACIÓN PARA SUELO EXTERIOR
 ВАРИАНТЫ ДЛЯ НАРУЖНОЙ УКЛАДКИ ПОЛА . 户外地面的铺贴解决方案



9MM - 20MM

posa a colla su massetto

Laying on screed with adhesive
 Pose a colle traditionnelle
 Traditionelle Verlegung auf Estrich
 Colocación con cola sobre solera
 Укладка на стяжку с использованием клея
 在找平层上用胶铺



20MM

posa a secco su erba

Dry laying on grass
 Pose à sec sur herbe
 Trockene Verlegung auf Gras
 Colocación en seco sobre hierba
 Прямая укладка на траву
 在草地上干铺



20MM

posa a secco su ghiaia o sabbia

Installation on gravel or sand
 Pose à sec sur le gravier et le sable
 Trockene Verlegung auf Kies und Sand
 Colocación en seco sobre gravilla
 Прямая укладка на гальку и песок
 在砾石及沙子上干铺



20MM

posa sopraelevata

Laying as raised paving
 Pose surélevée
 Trockene Verlegung auf Stützen
 Colocación sobreelevada
 Укладка фальшполов
 架高铺贴



Resistenza e sicurezza

INSTRUCTION FOR RAISED LAYING . INSTRUCTIONS POUR LA POSE SURÉLEVÉE
HINWEISUNGEN FÜR DIE VERLEGUNG AUF HOHLRAUMBODEN . RESISTENCIA Y SEGURIDAD
СОПРОТИВЛЕНИЕ И БЕЗОПАСНОСТЬ . 抗力及安全性

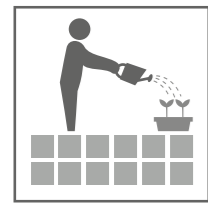

giardini
Gardens
Gärten
Jardins
Jardines
Сады
花园



terrazze
Patios and terraces
Terrassen
Terrasses
Terrazas
Террасы
台階

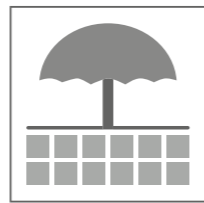

bar e ristoranti
Bars and restaurants
Bars und restaurants
Bars et restaurants
Bares y restaurantes
Бары и рестораны
酒吧及餐厅



arredo urbano
Street furnishing
Stadtmobiliar
Ameublement urbain
El mobiliario urbano
городское хозяйство
街头家具

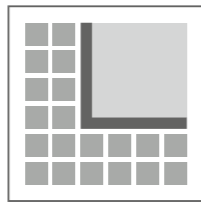

piscine e zone balneari
Swimming-pools and bathing areas
Schwimmbecken und Strandzonen
Piscines et zones balnéaires
Piscinas y áreas de baño
Бассейны и зоны купания
泳池及海水浴场

I vantaggi di un pavimento sopraelevato

THE ADVANTAGES OF A RAISED FLOOR
LES AVANTAGES D'UN DALLAGE SURÉLEVÉ
VORTEILE VON DOPPELBÖDEN

LAS VENTAJAS DE UN PAVIMENTO SOBREELEVADO
Преимущества фальшполов
高架地板的优点

- Risolve i problemi di livellamento.
- Permette l'alloggiamento di impianti elettrici e tubazioni.
- Facile da ispezionare.
- Immediato drenaggio dell'acqua piovana.
- Resistenza alla dilatazione termica.
- Migliora l'isolamento termico e acustico.
- Il sistema si assembla senza collanti.
- Riduce sensibilmente i tempi e i costi dell'opera.
- Riutilizzabile e sostituibile.
- L'assenza della base in massetto determina la riduzione del carico.

- Solves levelling problems.
- Allows space to house electrical systems and piping.
- Easy to inspect.
- Immediate drainage of rain water.
- Resistance to thermal expansion.
- Improves heating and sound insulation.
- The system is assembled without adhesives.
- Significantly reduces installation time and costs.
- Reusable and replaceable.
- The absence of a screed reduces the load.

- Beseitigung von Nivellierungsproblemen.
- Möglichkeit zur Unterbringung von Elektroanlagen und Rohrleitungen.
- Einfache Überprüfung.
- Unverzögliche Drainage des Regenwassers.
- Beständigkeit gegen Wärmedehnung.
- Verbesserung der thermischen und akustischen Isolierung.
- Verlegung des Systems ohne Kleber.
- Merkliche Verminderung der Verlegezeiten und -kosten.
- Wiederverwend- und auswechselbar.
- Verminderung der Last aufgrund der Abwesenheit des Untergrunds aus Estrich.

- Решают проблемы планировки.
- Позволяют размещение электропроводки и трубопровода.
- Легкий доступ для проверки.
- Мгновенный дренаж сточных вод.
- Стойкость к тепловому расширению.
- Улучшенные термоизоляция и звукоизоляция.
- Система устанавливается без использования клеящих веществ.
- Значительное снижение стоимости и сроков выполнения работ.
- Возможность повторного использования и замены.
- Отсутствие стяжки определяет снижение нагрузки.

- Elle résout les problèmes de nivellement.
- Elle permet l'intégration de circuits électriques et de conduites.
- Facile à inspecter.
- Drainage immédiat de l'eau de pluie.
- Résistance à la dilatation thermique.
- Meilleure isolation thermique et acoustique.
- On assemble le système sans colles.
- Réduit sensiblement les temps et les coûts de l'ouvrage.
- Réutilisable et remplaçable.
- L'absence de la chape de base détermine la réduction de la charge.

- Resuelve los problemas de nivelación.
- Permite pasar la instalación eléctrica y las tuberías.
- Fácil de inspeccionar.
- Drenaje inmediato del agua de lluvia.
- Resistencia a la dilatación térmica.
- Mejora el aislamiento térmico y acústico.
- El sistema se ensambla sin adhesivos.
- Reduce considerablemente el tiempo y el coste de la obra.
- Reutilizable y sustituible.
- La ausencia de la solera de soporte determina la reducción de la carga.

- 解决流平问题。
- 可以容纳电气系统和管道。
- 易于检查。
- 瞬间排放雨水。
- 耐热膨胀。
- 改善隔热和隔音效果。
- 该系统无需粘合剂即可组装。
- 它大大减少了工作时间和成本。
- 可重用和可替换。
- 没有实木基底，导致负荷减少。

Istruzioni per la posa sopraelevata 20MM

INSTRUCTION FOR RAISED LAYING . INSTRUCTIONS POUR LA POSE SURÉLEVÉE
HINWEISUNGEN FÜR DIE VERLEGUNG AUF HOHLRAUMBODEN . INSTRUCCIONES PARA COLOCACIÓN ELEVADA
ИНСТРУКЦИЯ ПО ПОДНЯТИЮ КЛАДКИ . 提升铺设指导

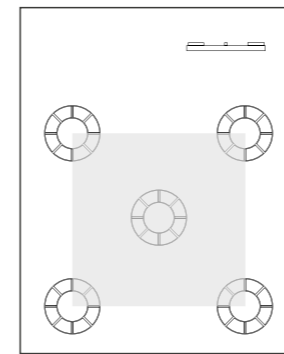

sopraelevato fino a 2 cm
5 supporti - 3+4 pz/mq

Raised Til < 2 Cm
5 Supports 3÷4 Pz/Sqm
Surèlevée Jusqu'a < 2 Cm
5 Supports 3÷4 Pz/Mq
Hohlraumboden < 2 Cm
5 Stelzer 3÷4 Pz/Mq
sobreelevado hasta 2 cm
5 soportes - 3 ÷ 4 pz/m2
ПОДЪЕМ ДО 2 CM
5 ОПОР - 3÷4 ШТ/КВ.М.
抬高至2厘米
5个支撑 - 3至4块/平方米

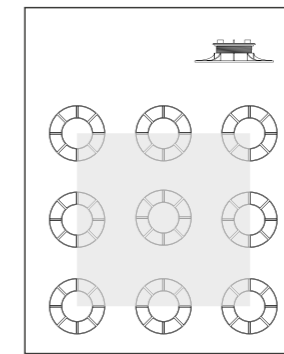

sopraelevato 2-10 cm
9 supporti - 6+7 pz/mq

Raised 2÷10 cm
9 supports 6÷7 pz/sqm
Surèlevée 2÷10 cm
9 supports 6÷7 pz/mq
Hohlraumboden 2÷10 cm
9 Stelzer 6÷7 pz/mq
sobreelevado 2 - 10 cm
9 soportes - 6 ÷ 7 pz/m2
ПОДЪЕМ 2 -10 CM
9 ОПОР - 6÷7 ШТ/КВ.М.
抬高2-10厘米
9个支撑 - 6至7块/平方米

CARATTERISTICHE TECNICHE DI SUPPORTO				
PHYSICAL PROPERTIES OF THE TILE'S BODY • CARACTÉRISTIQUES TECHNIQUES DU CORP DU CARREAU • TECHNISCHE EIGENSCHAFTEN DES SCHERBENS				
CARACTERÍSTICAS TÉCNICAS DE SOPORTE • ДОПОЛНИТЕЛЬНЫЕ ТЕХНИЧЕСКИЕ ХАРАКТЕРИСТИКИ • 支架的技术特性				
	GRES PORCELLANATO PORCELAIN GRÉS CÉRAME FEINSTEINZEUG GRES PORCELÁNICO КЕРАМОГРАНИТ 瓷质砖	NORMA STANDARD NORME NORM NORMA СТАНДАРТ 标准	VALORE PRESCRITTO DALLE NORME (UNI EN 14411 BIA) VALUES REQUIRED BY THE STANDARD VALEUR PRESCRITE PAR LES NORMES NORMVORGABE VALOR PRESCRITO POR LAS NORMAS ПОКАЗАТЕЛЬ, УСТАНОВЛЕННЫЙ СТАНДАРТОМ	VALORE GARDENIA ORCHIDEA GARDENIA ORCHIDEA VALUES VALEUR GARDENIA ORCHIDEA GARDENIA ORCHIDEA WERTE VALOR GARDENIA ORCHIDEA ПОКАЗАТЕЛЬ GARDENIA ORCHIDEA GARDENIA ORCHIDEA值
	Lunghezza e larghezza Length and width / Longueur et largeur Länge und Breite / Longitud y anchura Длина и ширина / 长度与宽度	UNI EN ISO 10545/2	± 0,6% (max ± 2mm)	± 0,6% (max ± 2mm)
	Spessore Thickness /Epaisseur Stärke / Espesor Толщина / 厚度	UNI EN ISO 10545/2	± 5% (max ± 0,5mm)	± 5% (max ± 0,5mm)
	Rettilineità spigoli Warpages of edges / Réctitude des arêtes Geradheit der Kanten / Rectitud de lados Прямолнейность ребер / 边的直线度	UNI EN ISO 10545/2	± 0,5% (max ± 1,5mm)	± 0,5% (max ± 1,5mm)
	Ortogonalità Wedging / Ortogonalité Rechtwinkligkeit / Ortogonalidad Ортогональность / 垂直度	UNI EN ISO 10545/2	± 0,5% (max ± 2mm)	± 0,5% (max ± 2mm)
	Planarità Flatness / Planéité Planität / Planitud Плоскость / 平整度	UNI EN ISO 10545/2	± 0,5% (max ± 2mm)	± 0,5% (max ± 2mm)
	Assorbimento d'acqua Water absorption / Absorption d'eau % Wasseraufnahme % / Absorción % de agua Водопоглощение в % / 水吸收率	UNI EN ISO 10545/3	≤ 0,5%	≤ 0,5%
	Resistenza alla flessione Bending strength / Résistance à la flexion Biegezugfestigkeit / Resistencia a la flexión Прочность при изгибе / 抗折强度	UNI EN ISO 10545/4	≥ 35 N/mm²	≥ 35 N/mm²
	Dilatazione termica lineare tra 20° e 100 °C Linear thermal expansion between 20° and 100 °C Dilatation thermique linéaire entre 20° et 100 °C Lineare Wärmeausdehnung zwischen 20° und 100 °C Dilatación térmica lineal entre 20° y 100°C 在20° 至100° C之间的线性热膨胀	UNI EN ISO 10545/8		< 9 (MK-1)
	Resistenza al gelo Frost resistance / Résistance au gel Frostbeständigkeit / Resistencia a la helada Морозостойкость / 防冻性	UNI EN ISO 10545/12		Nessuna alterazione No alteration - Aucune altération Keine Veränderung - Ninguna alteración НИКАКИХ ИЗМЕНЕНИЙ - 没有变化
	Resistenza alla flessione Bending strength / Résistance à la flexion Biegezugfestigkeit / Resistencia a la flexión Прочность при изгибе / 抗折强度	UNI EN ISO 10545/4	Richiesta Request - Demande Verlangt - Solicitud ЗАПРОСИТЬ - 请求	Nessuna alterazione No alteration - Aucune altération Keine Veränderung - Ninguna alteración НИКАКИХ ИЗМЕНЕНИЙ - 没有变化
	Resistenza all'abrasione profonda Resistance to deep abrasion / Résistance a l'abrasione profonde Tiefenabrieb / Resistencia a la abrasión profunda Сопротивление глубокому истиранию / 耐磨性	UNI EN ISO 10545/6	≤ 175 mm³	≤ 175 mm³

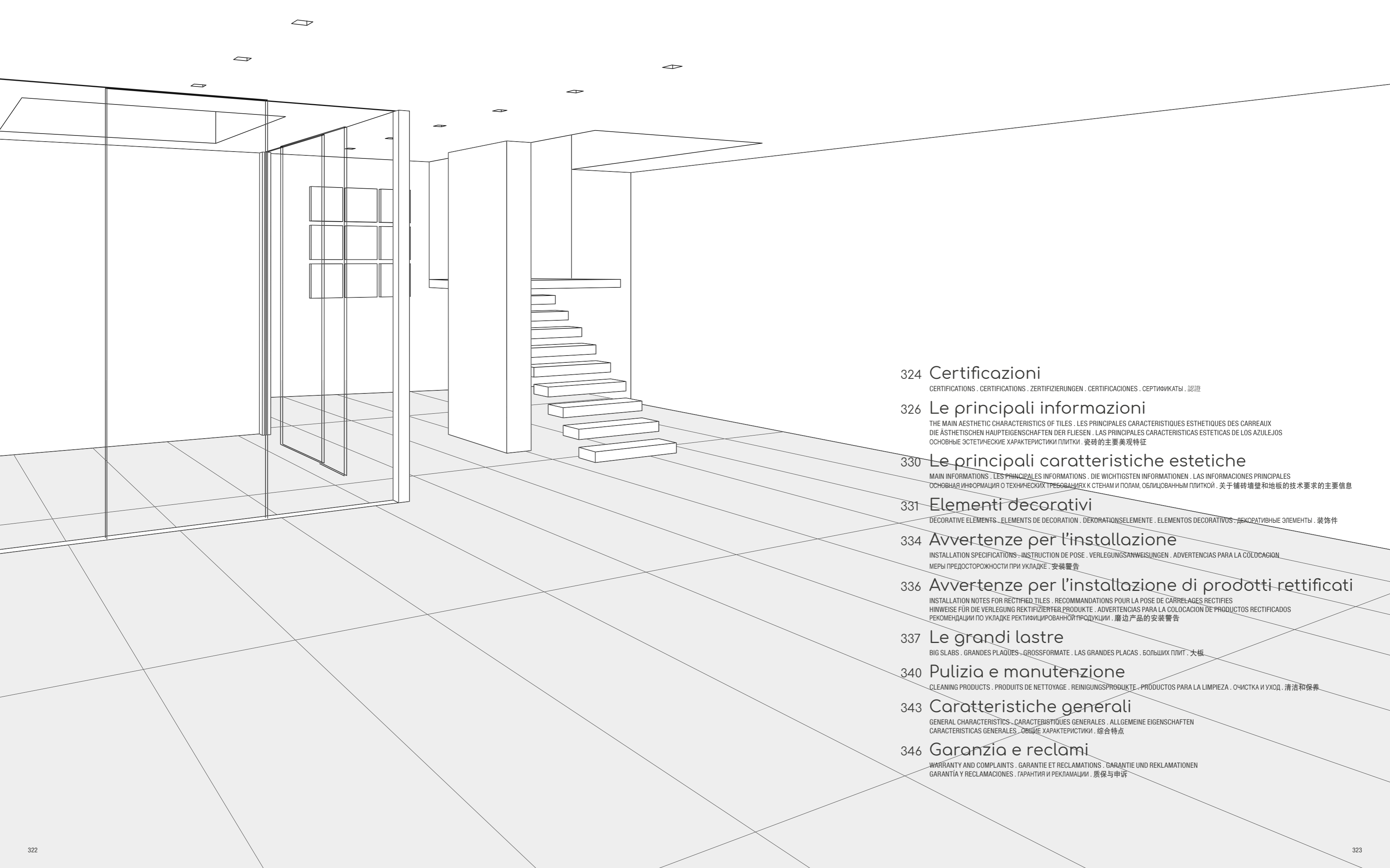

324 Certificazioni

CERTIFICATIONS . CERTIFICACIONES . ZERTIFIZIERUNGEN . CERTIFICACIONES . СЕРТИФИКАТЫ . 認證

326 Le principali informazioni

THE MAIN AESTHETIC CHARACTERISTICS OF TILES . LES PRINCIPALES CARACTERISTIQUES ESTHETIQUES DES CARREAUX
DIE ÄSTHETISCHEN HAUPTEIGENSCHAFTEN DER FLIESEN . LAS PRINCIPALES CARACTERISTICAS ESTETICAS DE LOS AZULEJOS
ОСНОВНЫЕ ЭСТЕТИЧЕСКИЕ ХАРАКТЕРИСТИКИ ПЛИТКИ . 瓷磚的主要美观特征

330 Le principali caratteristiche estetiche

MAIN INFORMATIONS . LES PRINCIPALES INFORMATIONS . DIE WICHTIGSTEN INFORMATIONEN . LAS INFORMACIONES PRINCIPALES
ОСНОВНАЯ ИНФОРМАЦИЯ О ТЕХНИЧЕСКИХ ТРЕБОВАНИЯХ К СТЕНАМ И ПОЛАМ, ОБЛИЦОВАННЫМ ПЛИТКОЙ . 关于铺砖墙壁和地板的技术要求的主要信息

331 Elementi decorativi

DECORATIVE ELEMENTS . ELEMENTS DE DECORATION . DEKORATIONSELEMENTE . ELEMENTOS DECORATIVOS . ДЕКОРАТИВНЫЕ ЭЛЕМЕНТЫ . 装饰件

334 Avvertenze per l'installazione

INSTALLATION SPECIFICATIONS . INSTRUCTION DE POSE . VERLEGUNGSANWEISUNGEN . ADVERTENCIAS PARA LA COLOCACION
МЕРЫ ПРЕДОСТОРОЖНОСТИ ПРИ УКЛАДКЕ . 安装警告

336 Avvertenze per l'installazione di prodotti rettificati

INSTALLATION NOTES FOR RECTIFIED TILES . RECOMMANDATIONS POUR LA POSE DE CARRELAGES RECTIFIES
HINWEISE FÜR DIE VERLEGUNG REKTIFIZIERTER PRODUKTE . ADVERTENCIAS PARA LA COLOCACION DE PRODUCTOS RECTIFICADOS
РЕКОМЕНДАЦИИ ПО УКЛАДКЕ РЕКТИФИЦИРОВАННОЙ ПРОДУКЦИИ . 磨边产品的安装警告

337 Le grandi lastre

BIG SLABS . GRANDES PLAQUES . GROSSFORMATE . LAS GRANDES PLACAS . БОЛЬШИХ ПЛИТ . 大板

340 Pulizia e manutenzione

CLEANING PRODUCTS . PRODUITS DE NETTOYAGE . REINIGUNGSPRODUKTE . PRODUCTOS PARA LA LIMPIEZA . ОЧИСТКА И УХОД . 清洁和保养

343 Caratteristiche generali

GENERAL CHARACTERISTICS . CARACTERISTIQUES GENERALES . ALLGEMEINE EIGENSCHAFTEN
CARACTERISTICAS GENERALES . ОБЩИЕ ХАРАКТЕРИСТИКИ . 综合特点

346 Garanzia e reclami

WARRANTY AND COMPLAINTS . GARANTIE ET RECLAMATIONS . GARANTIE UND REKLAMATIONEN
GARANTIA Y RECLAMACIONES . ГАРАНТИЯ И РЕКЛАМАЦИИ . 质保与申诉

Certificazioni

CERTIFICATIONS • CERTIFICACIONES • ZERTIFIZIERUNGEN • CERTIFICACIONES • СЕРТИФИКАТЫ • 認證



Ceramiche Gardenia Orchidea ha un Sistema di Gestione per la Qualità Certificato da Kiwa Cermet Italia S.p.A. secondo la norma ISO 9001:2015.

Ceramiche Gardenia Orchidea has a Quality Management System Certificate by Kiwa Cermet Italia S.p.A. according to ISO 9001:2015.
Ceramiche Gardenia Orchidea possède un système de management pour la qualité certifié par Kiwa Cermet Italia S.p.A., conformément à la norme ISO 9001:2015.
Ceramiche Gardenia Orchidea verfügt über ein von Kiwa Cermet Italia S.p.A. zertifiziertes Qualitätsmanagementsystem gemäß ISO 9001:2015.
Ceramiche Gardenia Orchidea dispone de un Sistema de Gestión para la Calidad certificado por Kiwa Cermet Italia S.p.A. de conformidad con la norma ISO 9001:2015.
КОМПАНИЯ СЕРАМИЧЕ ГАРДЕНИЯ ОРХИДЕА ИМЕЕТ СЕРТИФИКАТ СООТВЕТСТВИЯ СИСТЕМ УПРАВЛЕНИЯ КАЧЕСТВОМ СТАНДАРТАМ ISO 9001:2015, ВЫДАННЫЙ КОМПАНИЕЙ КИВА СЕРМЕТ ИТАЛИА С.П.А.
Ceramiche Gardenia Orchidea 公司拥有由 Kiwa Cermet Italia S.p.A. 公司认证的质量管理体系，符合 ISO 9001:2015 标准。



1) NASTOCER

Progetto relativo al programma comunitario CIP ECO INNOVATION che si propone di industrializzare un nuovo trattamento per la produzione di piastrelle ceramiche simili alla pietra naturale, in grado di sostituire completamente l'attuale fase di finitura superficiale.

2) WAP-WIR

Progetto relativo al programma comunitario CIP ECO INNOVATION che si propone di ridurre l'impatto ambientale della produzione dei materiali decorativi a rilievo e a basso-rilievo, comunemente realizzati in resina, sostituendoli con matrici polimeriche composite miscelate a polveri di pietra naturale e di vetro, in un processo a bassissime temperature.

3) ECO BULL-NOSE 2.0

Progetto relativo al programma comunitario CIP ECO INNOVATION che ha come scopo quello di ridurre l'impatto ambientale della fase di lavorazione di una determinata tipologia di pezzi speciali (bull-nose), grazie a speciali polimeri e alla separazione di acqua e reflui abrasivi dai fanghi di taglio e profilatura.

- 1) Project included in the CIP ECO INNOVATION Community Programme, aimed at the industrialization of a new manufacturing process of ceramic tiles that mimic natural stone and hence can entirely replace the current phase of surface finishing.
- 2) Project included in the CIP ECO INNOVATION Community Programme, aimed at reducing the environmental impact caused by the manufacture of relief and bas-relief decorative elements, usually made with resin, by replacing them with composite polymer matrixes blended with natural stone and glass dust, processed at very low temperature.
- 3) Project included in the CIP ECO INNOVATION Community Programme, aimed at reducing the environmental impact caused by the manufacture of a specific type of special parts (bull-nose), thanks to special polymers and the separation of water and abrasive waste derived from cutting and profiling sludge.

- 1) Projet relatif au programme communautaire CIP ECO INNOVATION qui entend industrialiser un nouveau traitement pour la fabrication des carreaux de céramique similaires à la pierre naturelle, en mesure de remplacer complètement l'actuelle phase de finition des surfaces.
- 2) Projet relatif au programme communautaire CIP ECO INNOVATION qui entend réduire l'impact environnemental de la fabrication du matériel décoratif en relief et à bas-relief, habituellement réalisés en résine, en les remplaçant par des matrices polymériques composites mélangées à des poudres de verre et de pierre naturelle, selon un processus à de très basses températures.
- 3) Projet relatif au programme communautaire CIP ECO INNOVATION qui a le but de réduire l'impact environnemental de la phase d'usinage d'une typologie déterminée de pièces spéciales (bull-nose) moyennant des polymères spéciaux et grâce à la séparation de l'eau et des effluents abrasifs des boues de coupe et de profilage.

- 1) Ein Projekt des Programms CIP ECO INNOVATION der Europagemeinschaft, das sich im Rahmen der Produktion natursteinähnlicher Keramikfliesen die Industrialisierung einer neuen Behandlung zum Ziel setzt, die die aktuelle Oberflächenbearbeitungsphase komplett ersetzt.
- 2) Ein Projekt des Programms CIP ECO INNOVATION der Europagemeinschaft mit dem Zweck, die Umweltauswirkungen der Produktion von normalerweise mit Harzen gefertigten Relief- und Basrelief-Dekorationsmaterialien zu reduzieren, indem die Harze in einem Prozess mit extrem niedrigen Temperaturen durch mit Naturstein- und Glaspulvern gemischter Polymerverbund-Matrix ersetzt werden.
- 3) Ein Projekt des Programms CIP ECO INNOVATION der Europagemeinschaft mit dem Zweck, die Umweltauswirkungen der Bearbeitungsphase einer bestimmten Spezialteile-Typologie (bull-nose) zu reduzieren, dank spezieller Polymere und der Trennung von Wasser und Abwasser mit kratzender Verschmutzung von Schneide- und Profilierungsschlämmen.

- 1) Proyecto afín al programa comunitario CIP ECO INNOVATION, el cual se propone industrializar un nuevo tratamiento para la producción de azulejos cerámicos similares a la piedra natural, capaz de sustituir completamente la fase de acabado superficial actual.
- 2) Proyecto afín al programa comunitario CIP ECO INNOVATION, el cual se propone reducir el impacto ambiental causado por la producción de materiales decorativos en relieve y bajo relieve, comúnmente fabricados con resinas, sustituyéndolos por matrices poliméricas compuestas obtenidas a partir de la mezcla de polvos de piedra natural y de vidrio, mediante un proceso que actúa a muy bajas temperaturas.
- 3) Proyecto afín al programa comunitario CIP ECO INNOVATION, cuyo objetivo es reducir el impacto ambiental de la fase de fabricación de una determinada tipología de piezas especiales (bull-nose), gracias a polímeros particulares y a la separación de agua y efluentes abrasivos de los lodos resultantes de los procesos de corte y perfilado.

- 1) Проект в рамках общеевропейской программы CIP ECO INNOVATION предусматривает промышленное освоение нового типа обработки для производства керамической плитки, схожей с натуральным камнем, в состоянии полностью заменить выполняемую в настоящее время фазу обработки поверхности.
- 2) Проект в рамках общеевропейской программы CIP ECO INNOVATION предусматривает снижение вредного воздействия на окружающую среду производства декоративных материалов с низким и высоким рельефом, реализуемых, как правило, из смолы, с их заменой полимерными композитными матрицами, смешанными с порошками из натурального камня и стекла при низкотемпературных процессах.
- 3) Предназначением проекта в рамках общеевропейской программы CIP ECO INNOVATION является снижение вредного воздействия на окружающую среду фазы обработки определенного типа специальных изделий (bull-nose), благодаря использованию специальных полимеров и отделению воды и абразивных стоков от шлаков, образующихся при резке и профилировании.

- 1) 欧盟CIP生态创新相关项目，目的是开发新的用于生产类天然石材的陶瓷墙地砖表面处理的工业化生产方法，从而完全取代目前使用的表面处理方法。
- 2) 欧盟CIP生态创新相关项目，目的是减少浮雕和浅浮雕装饰材料生产过程对环境的负面影响，用高分子聚合物加天然石材和玻璃复合粉末，在极低的温度下加工处理，取代一般使用的树脂材料。
- 3) 欧盟CIP生态创新相关项目，目的是减少某一特殊件（斗牛鼻）特定类型的加工工序对环境的负面影响，通过使用特殊的高分子聚合物和将水和磨料从切割和打磨制造的污泥中分离而完成。



EN 14411:2012

Marcatura CE / CE Mark / Marquage CE / CE-Kennzeichnung / Marca CE / МАРКИРОВКА CE / CE标志

Per ulteriori informazioni, approfondimenti e download delle marcature CE: www.gardenia.it

For further details and information and to download CE marks: www.gardenia.it

Pour obtenir de plus amples informations, approfondir et télécharger le marques CE: www.gardenia.it

Für weitere Informationen and Downloads der CE-Kennzeichnungen: www.gardenia.it

Para obtener más información y descargar las marcas CE: www.gardenia.it

ПОЛУЧИТЬ ДОПОЛНИТЕЛЬНУЮ, БОЛЕЕ ПОДРОБНУЮ ИНФОРМАЦИЮ, А ТАКЖЕ СГРУЗИТЬ МАРКИРОВКУ CE МОЖНО НА САЙТЕ: www.gardenia.it

更多关于CE标准信息，请于www.gardenia.it网站中下载



放射性水平A类

Marcatura CCC / CCC Mark / Marquage CCC / CCC-Kennzeichnung / Marca CCC / МАРКИРОВКА CCC / CCC标志

Certificazione obbligatoria per l'esportazione in Cina

Certification mandatory for export to China

Certification obligatoire pour l'exportation en Chine

Für den Export nach China obligatorische Zertifizierung

Certificación obligatoria para la exportación a China

Обязательная сертификация для экспорта в Китай

出口到中国的强制性认证

ENERGEO

Progetto dimostrativo sostenuto dallo strumento finanziario LIFE+ dalla Commissione Europea, che intende dimostrare la fattibilità dell'applicazione di geopolimeri alla produzione di piastrelle da pavimentazione, riducendo consumi energetici ed emissioni di gas serra di oltre l'80% rispetto alla produzione tradizionale.

A demonstrative project held with the support of the financial instrument LIFE+ of the European Commission, meant to prove the feasible application of geopolymers to flooring tile manufacture, thus reducing energy consumption and greenhouse gas emissions by more than 80% if compared with the traditional process.

Projet démonstratif avec le soutien de l'instrument financier LIFE+ et de la Commission Européenne, qui entend démontrer la faisabilité de l'application de géo-polymères à la fabrication des carreaux de revêtement de sols, en réduisant de plus de 80% les consommations énergétiques et les émissions de gaz de serre par rapport à la fabrication traditionnelle.

Demonstratives Projekt, unterstützt vom finanziellen Mittel LIFE+ der Europakommission, das die Machbarkeit der Anwendung von Geopolymeren bei der Produktion von Bodenfliesen beweisen soll, bei gleichzeitiger über 80%iger Reduzierung der Energieverbrauche und der Emissionen von Treibhausgas im Vergleich zur traditionellen Produktion.

Proyecto demostrativo efectuado por el instrumento financiero LIFE+ de la Comisión Europea, que pretende probar la factibilidad de aplicar geopolímeros en la producción de azulejos, reduciendo el consumo de energía y las emisiones de gases de efecto invernadero en más de un 80% respecto de la producción tradicional.

ПОКАЗАТЕЛЬНЫЙ ПРОЕКТ, РЕАЛИЗУЕМЫЙ ПРИ ПОДДЕРЖКЕ ФИНАНСОВОГО ИНСТРУМЕНТА LIFE+ ЕВРОПЕЙСКОЙ КОМИССИИ, НАЦЕЛЕННЫЙ НА ПРЕДЪЯВЛЕНИЕ ДОКАЗАТЕЛЬСТВА ОСУЩЕСТВЛЕНИЯ ПРИМЕНЕНИЯ ГЕОПОЛИМЕРОВ В ПРОИЗВОДСТВЕ НАПОЛЬНОЙ ПЛИТКИ, С СОКРАЩЕНИЕМ ЭНЕРГОПОТРЕБЛЕНИЯ И ВЫБРОСОВ ПАРНИКОВОГО ГАЗА НА БОЛЕЕ ЧЕМ 80% ПО СРАВНЕНИЮ С ТРАДИЦИОННЫМ ПРОИЗВОДСТВОМ.

由欧洲委员会 LIFE+ 资金支持示范性项目，目的在于证实应用土壤聚合物生产地磚的可行性，该工序比传统工序可以减少超过 80% 的能源消耗和温室气体排放。

Le principali informazioni

MAIN INFORMATIONS • LES PRINCIPALES INFORMATIONS • DIE WICHTIGSTEN INFORMATIONEN • LAS INFORMACIONES PRINCIPALES
ОСНОВНАЯ ИНФОРМАЦИЯ О ТЕХНИЧЕСКИХ ТРЕБОВАНИЯХ К СТЕНАМ И ПОЛАМ, ОБЛИЦОВАННЫМ ПЛИТКОЙ • 关于铺砖墙壁和地板的技术要求的主要信息

LE PRINCIPALI INFORMAZIONI SUI REQUISITI TECNICI DELLE PARETI E DEI PAVIMENTI PIASTRELLATI.

Il carattere estetico della ceramica è il criterio sicuramente più importante per formulare una preferenza nei confronti di una linea di piastrelle Gardenia Orchidea; ma spesso non basta. Possiamo offrirvi una vasta scelta di piastrelle dalle caratteristiche tecniche diversificate, per adattarsi al meglio ad ogni particolare destinazione d’uso, e per assecondare tutte le vostre esigenze.

La piastrella è, di per sé, un materiale molto resistente ai vari tipi di sollecitazione. Ma si deve comunque scegliere la piastrellatura più adatta al tipo di superfice da rivestire, seguendo alcune semplici indicazioni tecniche.

La prima distinzione a cui fare attenzione riguarda il posizionamento della piastrella, che può essere da esterno o da utilizzare solo all’interno di un’abitazione. Può altresì essere progettata da collocarsi solo a parete come rivestimento piuttosto che come pavimento, e quindi studiata per essere sottoposta al peso dei mobili, agli urti e all’usura dovuta al calpestio.

Per maggiore chiarezza, in questo catalogo, ogni prodotto sarà accompagnato da un simbolo che ne consiglia uno o più specifici utilizzi.

Il simbolo indica il tipo di ambiente in cui il prodotto può essere utilizzato.
Il simbolo indica il tipo di ambiente in cui il prodotto può essere utilizzato.
Il simbolo indica il tipo di ambiente in cui il prodotto può essere utilizzato.

MAIN INFORMATION ON THE TECHNICAL REQUIREMENTS OF FLOOR TILES

The aesthetic quality of ceramic tile is the most important criterion when choosing a line of Gardenia Orchidea tiles, but often it is not enough. We can offer you an enormous range of tiles with diversified technical characteristics to provide the perfect solution for any application and to meet all your requirements. Tiles are inherently resistant to various kinds of stress. Nonetheless, the most suitable tiling for the type of surface must be chosen according to a few simple technical guidelines. The first aspect that must be taken into consideration is the position of the tile, which may be outdoors or for use solely inside a house. Likewise, a tile may be intended for use solely as a wall covering rather than for use on a floor and therefore not designed to withstand the weight of furniture or the shock and wear of foot traffic. For more cleamess, each product in this catalogue is accompanied by a symbol recommending one or more specific applications.

Il simbolo indica il tipo di ambiente in cui il prodotto può essere utilizzato.
Il simbolo indica il tipo di ambiente in cui il prodotto può essere utilizzato.
Il simbolo indica il tipo di ambiente in cui il prodotto può essere utilizzato.

DIEWICHTIGSTENINFORMATIONENZUDENTECHNISCHENANFORDERUNGENANGEFLIESTEWÄNDEUND FUSSBÖDEN

Sicher spielt die Optik der Keramik eine herausragende, wenn nicht sogar die wichtigste Rolle bei der Auswahl einer Fliesenlinie Gardenia Orchidea. Dies allein reicht allerdings oft nicht aus. Wir können Ihnen eine breitgefächerte Auswahl an Fliesen mit unterschiedlichen technischen Merkmalen anbieten. Auf dieser Grundlage kann eine perfekte Anpassung an die Besonderheiten des jeweiligen Verwendungsbereichs erfolgen und Ihre Bedürfnisse werden rundum befriedigt. Die Fliese ist von Natur aus ein sehr widerstandsfähiges Material, das den unterschiedlichsten Beanspruchungen stand hält. Dennoch muss jeweils die richtige Fliese für die zu fliesende Oberfläche ausgewählt werden. Dabei sollten einige einfache technische Angaben befolgt werden. Allem voran muss auf den Bestimmungsort der Fliese geachtet werden. Entsprechend unterscheidet man Außen- und Innenraumfliesen sowie Wand- und Bodenfliesen. Bei letzteren muss beispielsweise das Gewicht der Möbel mit berücksichtigt werden. Außerdem müssen sie stoßfest und auch bei starker Beanspruchungen verschleißsicher sein. Der Klarheit halber ist in diesem Katalog jedes Produkt mit einem Symbol, das eine oder mehrere spezifischen Anwendungen empfiehlt.

Il simbolo indica il tipo di ambiente in cui il prodotto può essere utilizzato.
Il simbolo indica il tipo di ambiente in cui il prodotto può essere utilizzato.
Il simbolo indica il tipo di ambiente in cui il prodotto può essere utilizzato.

ОСНОВНАЯ ИНФОРМАЦИЯ О ТЕХНИЧЕСКИХ ТРЕБОВАНИЯХ К СТЕНАМ И ПОЛАМ, ОБЛИЦОВАННЫМ ПЛИТКОЙ

Эстетический характер керамики - это, несомненно, самый важный критерий для формирования предпочтений в отношении линии плитки Gardenia Orchidea, но иногда этого недостаточно. Мы можем предложить вам широкий выбор плитки с различными техническими характеристиками, чтобы лучше приспособиться к условиям конечного применения и удовлетворить все ваши требования. Плитка сама по себе – это очень устойчивый материал к воздействиям различных нагрузок. Но в любом случае следует выбирать плитку, наиболее подходящую для типа поверхности, которую предстоит облицевать, следуя некоторым простым техническим указаниям. Первое отличие, на которое следует обратить внимание, касается размещения плитки, которое может быть наружным либо только для использования внутри помещения. Плитка может также предназначаться для использования в качестве настенной облицовки, или же для покрытия пола, и, следовательно, в этом случае изучается, чтобы подвергнуться весу мебели, ударам, изнашиванию по причине движения. Для наибольшей ясности в этом каталоге каждый продукт будет сопровождаться символом, который рекомендует один или более типов специального применения.

Il simbolo indica il tipo di ambiente in cui il prodotto può essere utilizzato.
Il simbolo indica il tipo di ambiente in cui il prodotto può essere utilizzato.
Il simbolo indica il tipo di ambiente in cui il prodotto può essere utilizzato.

LES PRINCIPALES INFORMATIONS SUR LES STANDARDS TECHNIQUES DES CARRELAGES DE SOL

Le caractère esthétique de la céramique constitue le critère essentiel, le plus important pour formuler une préférence à l’égard d’une ligne de carreaux Gardenia Orchidea; souvent toutefois, ce critère ne suffit pas. Aussi nous sommes en mesure de vous proposer un vaste choix de carreaux aux caractéristiques techniques les plus diverses pour répondre au mieux au type d’utilisation prévue ainsi qu’à vos besoins propres. Le carreau est en soi un matériel qui offre une grande résistance aux sollicitations les plus diverses. Il est néanmoins nécessaire de choisir le carrelage le mieux adapté au type de surface à revêtir en respectant quelques simples recommandations techniques. La première distinction à faire concerne le lieu où le carreau sera posé, qui peut être à l’extérieur ou à utiliser exclusivement à l’intérieur d’une habitation. Il peut également être conçu pour le revêtement mural plutôt que pour le revêtement de sol et donc étudié pour supporter le poids de meubles et pour résister aux chocs et à l’usure induite par le cheminement. En vue de donner clarté, dans le présent catalogue, chaque produit est accompagné d’un symbole pour conseiller une ou plusieurs utilisations spécifiques.

Il simbolo indica il tipo di ambiente in cui il prodotto può essere utilizzato.
Il simbolo indica il tipo di ambiente in cui il prodotto può essere utilizzato.
Il simbolo indica il tipo di ambiente in cui il prodotto può essere utilizzato.

LAS INFORMACIONES PRINCIPALES ACERCA DE LOS REQUISITOS TECNICOS DE LOS PAVIMENTOS REVESTIDOS CON AZULEJOS

El carácter estético de la cerámica es el criterio principal, probablemente el más importante, a la hora de decidirse por una línea de azulejos Gardenia Orchidea; pero a menudo no es suficiente. Ponemos a su disposición una amplia gama de azulejos de diferentes características técnicas, que se adaptan para lo mejor a cada uso específico y que responden a todas sus necesidades. El azulejo es, por sí mismo, un material muy resistente a los diferentes tipos de estímulos. Pero debe escogerse el azulejo más adecuado para el tipo de superficie que debe revestirse, siguiendo algunas sencillas indicaciones técnicas. La primera consideración a la que debemos prestar atención está relacionada con la colocación del azulejo que puede estar estudiado para el exterior o el interior de la vivienda, o bien estar diseñado para colocarse sólo en la pared como revestimiento más que como pavimento, y por lo tanto, para ser sometido al peso de los muebles, a los golpes y al desgaste producido por el tráfico. Para mayor claridad, en este catálogo cada producto se acompañará por un símbolo que aconseja uno o más usos específicos del producto.

Il simbolo indica il tipo di ambiente in cui il prodotto può essere utilizzato.
Il simbolo indica il tipo di ambiente in cui il prodotto può essere utilizzato.
Il simbolo indica il tipo di ambiente in cui il prodotto può essere utilizzato.

LES INFORMACIONES PRINCIPALES ACERCA DE LOS REQUISITOS TECNICOS DE LOS PAVIMENTOS REVESTIDOS CON AZULEJOS

El carácter estético de la cerámica es el criterio principal, probablemente el más importante, a la hora de decidirse por una línea de azulejos Gardenia Orchidea; pero a menudo no es suficiente. Ponemos a su disposición una amplia gama de azulejos de diferentes características técnicas, que se adaptan para lo mejor a cada uso específico y que responden a todas sus necesidades. El azulejo es, por sí mismo, un material muy resistente a los diferentes tipos de estímulos. Pero debe escogerse el azulejo más adecuado para el tipo de superficie que debe revestirse, siguiendo algunas sencillas indicaciones técnicas. La primera consideración a la que debemos prestar atención está relacionada con la colocación del azulejo que puede estar estudiado para el exterior o el interior de la vivienda, o bien estar diseñado para colocarse sólo en la pared como revestimiento más que como pavimento, y por lo tanto, para ser sometido al peso de los muebles, a los golpes y al desgaste producido por el tráfico. Para mayor claridad, en este catálogo cada producto se acompañará por un símbolo que aconseja uno o más usos específicos del producto.

Il simbolo indica il tipo di ambiente in cui il prodotto può essere utilizzato.
Il simbolo indica il tipo di ambiente in cui il prodotto può essere utilizzato.
Il simbolo indica il tipo di ambiente in cui il prodotto può essere utilizzato.

关于铺砖墙壁和地板的技术要求的主要信息

陶瓷的美观特点肯定是Gardenia Orchidea瓷砖系列的最重要制造标准；但通常还远不止于此。我们可以为您提供选择广泛、具有不同技术特征的瓷砖，以更好地适应每一特殊用途，并符合您的所有需求。瓷砖是一种极能抵抗各种应力的材料，但必须根据简单的技术说明，选择最适合施工表面的瓷砖铺设。首先必须注意的是区别瓷砖的铺设位置，可能是用于室外，或者只用于室内。也可能只用于铺设墙壁，或者用于铺设地板，因此必须经过研究，以便能承受家具重量、碰撞以及由于践踏导致的损耗。为了说明得更加清楚，本目录对每一产品都附有建议作一或多项专门用途的标志。

Il simbolo indica il tipo di ambiente in cui il prodotto può essere utilizzato.
Il simbolo indica il tipo di ambiente in cui il prodotto può essere utilizzato.
Il simbolo indica il tipo di ambiente in cui il prodotto può essere utilizzato.

PAVIMENTO
Floor tile
Sol
Boden
Piso
Полы
地砖

RIVESTIMENTO
Wall tile
Revêtement mural
Wand
Revestimiento pared
Облицовка
墙砖

Il simbolo indica il tipo di ambiente in cui il prodotto può essere utilizzato.
Il simbolo indica il tipo di ambiente in cui il prodotto può essere utilizzato.
Il simbolo indica il tipo di ambiente in cui il prodotto può essere utilizzato.

RETTIFICATO
Rectified
Rectifié
Rektifiziert
Rectificado
Ректифицированный
磨边砖

PAVIMENTI PER ESTERNO
Outdoor floors
Carrelages d’extérieur
Bodenbeläge im Außenbereich
Pavimentos para exteriores
Полы для наружных пространств
室外地砖

Il simbolo indica il tipo di ambiente in cui il prodotto può essere utilizzato.
Il simbolo indica il tipo di ambiente in cui il prodotto può essere utilizzato.
Il simbolo indica il tipo di ambiente in cui il prodotto può essere utilizzato.

RESISTENTE AL GELO
Frost resistant
Résistant au gel
Frostbeständig
Resistencia al hielo
Морозоустойчивый
防冻

Il simbolo indica il tipo di ambiente in cui il prodotto può essere utilizzato.
Il simbolo indica il tipo di ambiente in cui il prodotto può essere utilizzato.
Il simbolo indica il tipo di ambiente in cui il prodotto può essere utilizzato.

RESISTENTE AGLI SBALZI TERMICI
Thermal shock resistant
Résistant aux écarts thermiques
Temperaturwechselbeständigkeit
Resistencia a las variaciones térmicas
Устойчивый к термоударам
耐热度波动

Il simbolo indica il tipo di ambiente in cui il prodotto può essere utilizzato.
Il simbolo indica il tipo di ambiente in cui il prodotto può essere utilizzato.
Il simbolo indica il tipo di ambiente in cui il prodotto può essere utilizzato.

RESISTENZA ALLO SCIVOLAMENTO: I VALORI INDICATI NEL PRESENTE CATALOGO SONO RIFERITI A TEST ESEGUITI A CAMPIONE CHE POSSONO SUBIRE VARIAZIONI NEI DIVERSI LOTTI PRODUTTIVI. SI RACCOMANDA AL MOMENTO DELL'ORDINE DI INDICARE A GARDENIA ORCHIDEA S.P.A. L'UTILIZZO A CUI IL PRODOTTO SARÀ DESTINATO AFFINCHÉ L'AZIENDA POSSA VERIFICARE L'EFFETTIVA CORRISPONDENZA DEL GRADO DI ANTISDRUCCIOLLO NECESSARIO CON QUELLO DEL MATERIALE OGGETTO DI FORNITURA.

Slip resistance: the values indicated in this catalogue refer to tests carried out on samples that may vary from one production batch to another. We recommend that you inform us of the use to which the product will be put at the time the order is placed so that Gardenia Orchidea S.p.A can make sure that the non-slip characteristics of the materials supplied correspond to the actual requirements.

Résistance au glissement : les valeurs indiquées au présent catalogue se rapportent à des tests exécutés par échantillonnage susceptibles de subir des variations dans les différents lots de production. Il est recommandé lors de la commande d’indiquer à Gardenia Orchidea S.p.A l’utilisation, à laquelle le produit sera destiné, afin que l’entreprise puisse vérifier la correspondance effective du degré antidérapant nécessaire à celui de la matière faisant l’objet de la fourniture.

Rutschfestigkeit: Die in diesem Katalog aufgeführten Werte beziehen sich auf Tests an Proben, die Variationen hinsichtlich der verschiedenen Produktionschargen aufweisen können. Es wird empfohlen, bei der Bestellung bei Gardenia Orchidea S.p.A anzugeben, welcher Einsatz für das Produkt vorgesehen ist, damit die Firma die effektive Rutschfestigkeit des bestellten Materials prüfen kann.

Resistencia a resbalar: los valores indicados en el presente catálogo se refieren a pruebas realizadas con muestreo que pueden acusar variaciones en los diferentes lotes de producción. En el momento de realizar el pedido, se recomienda indicar a Gardenia Orchidea S.p.A el tipo de uso al cual se destinará el producto, de modo que la empresa verifique la correcta correspondencia entre el grado de antideslizamiento requerido con el del material a suministrar.

Устойчивость к скольжению: значения,приведенные в данном каталоге, относятся к испытаниям, проведенным на образце. Данные значения могут варьироваться в разных произведенных партиях. В момент заказа рекомендуем указать Gardenia Orchidea S.p.A. использование, для которого предназначается изделие, с тем, чтобы компания могла проверить фактическое соответствие необходимой степени устойчивости к скольжению материала, являющегося предметом поставки.

防滑：适应 在图册上标注的防滑值是参考样品的测试，不同批次会有差别。特别注意在订货时要告知加德尼亚，在目的地如何使用产品，以便工厂能够确认所提供的产品与所需要的防滑级别相

Il simbolo indica il tipo di ambiente in cui il prodotto può essere utilizzato.
Il simbolo indica il tipo di ambiente in cui il prodotto può essere utilizzato.
Il simbolo indica il tipo di ambiente in cui il prodotto può essere utilizzato.

CON QUESTO TERMINE SI VUOLE INDICARE IL GRADO (V1, V2, V3, V4) DI VARIAZIONE CROMATICA FRA PIASTRELLA E PIASTRELLA RACCHIUSO IN OGNI SCATOLA DI PRODOTTO MARCHIATO.

This symbol (V1, V2, V3, V4) classifies the chromatic shade variation among pieces of tile in one box of the collection.

Parmi les symboles (V1, V2, V3, V4) nous indiquons le degré de variation chromatique entre les carreaux contenus dans chaque carton de produit à marque.

Mit den Abkürzungen (V1, V2, V3, V4) will man den Farbabweichungsgrad unter den Fliesen jeden Kartons von der Kollektion weisen.

Con los matices (V1, V2, V3, V4) indique un grado de variacion en los colores y en las superficies de la colleccion.

Термин указывает на степень (V1, V2, V3, V4) отклонения цвета керамической плитки в каждой коробке изделий под знаком.

这个词表示商标的每箱产品中瓷砖之间的色彩变化度（ V1, V2, V3, V4 ）。

Il simbolo indica il tipo di ambiente in cui il prodotto può essere utilizzato.
Il simbolo indica il tipo di ambiente in cui il prodotto può essere utilizzato.
Il simbolo indica il tipo di ambiente in cui il prodotto può essere utilizzato.

POSA CONSIGLIATA CON FUGA
Suggested laying with joint
Pose conseillée avec joint
Verlegung mit Fuge empfohlen
Colocación aconsejada con junta
Рекомендуется укладка со швом
建议的留缝隙施工

PRODOTTI CON PEZZI NON MODULARI DA POSARE IN DIAGONALE
Products with non-modular pieces which have to be laid diagonally
Produits avec pièces non-modulaires à poser en diagonal
Produkte mit nicht-modul Stücke nur fuer Schraegverlegung empheft
Productos con piezas non modulares para posa en diagonal
Продукты с немодульными элементами для укладки по диагонали
含有用于斜铺的非标准件的产品

Il simbolo indica il tipo di ambiente in cui il prodotto può essere utilizzato.
Il simbolo indica il tipo di ambiente in cui il prodotto può essere utilizzato.
Il simbolo indica il tipo di ambiente in cui il prodotto può essere utilizzato.

9 MM
20 MM

SPESSORE MAGGIORATO
Increased thickness
Epaisseur majorée
Erhöhte Stärke
Espesor aumentado
Увеличенная толщина
加厚厚度

Il simbolo indica il tipo di ambiente in cui il prodotto può essere utilizzato.
Il simbolo indica il tipo di ambiente in cui il prodotto può essere utilizzato.
Il simbolo indica il tipo di ambiente in cui il prodotto può essere utilizzato.

CLASSE DI RESISTENZA ALL'ABRASIONE SUPERFICIALE (DOVE INDICATO)
Class of resistance to surface abrasion (where indicated)
Classe de résistance à l’abrasion superficielle (où mentionné)
Oberflächenabrieb-Beanspruchungsgruppe (wo bezeichnet)
Clase de resistencia a la abrasión superficial (cuando indicado)
Класс сопротивляемости поверхности истиранию (где указано)
耐表面磨蚀等级 (标示之处)

Il simbolo indica il tipo di ambiente in cui il prodotto può essere utilizzato.
Il simbolo indica il tipo di ambiente in cui il prodotto può essere utilizzato.
Il simbolo indica il tipo di ambiente in cui il prodotto può essere utilizzato.

MISCELARE I PEZZI DURANTE LA POSA, PRELEVANDOLI DA SCATOLE DIFFERENTI
Tiles have to be taken from different boxes and mixed while laying
Mélanger les carreaux au moment de la pose, en les prélevant de différentes boites
Die Fliesen aus mehreren Kartons entnehmen und vor der Verlegung mischen
Mezclar las baldosas ceramicas sacandolas desde distintas cajas antes que colocarlas
При укладке взять плитки из разных коробок для получения равномерного результата
用不同箱子的砖板,放在地面就得到混合的效果

Il simbolo indica il tipo di ambiente in cui il prodotto può essere utilizzato.
Il simbolo indica il tipo di ambiente in cui il prodotto può essere utilizzato.
Il simbolo indica il tipo di ambiente in cui il prodotto può essere utilizzato.

Le principali informazioni

MAIN INFORMATIONS • LES PRINCIPALES INFORMATIONS • DIE WICHTIGSTEN INFORMATIONEN • LAS INFORMACIONES PRINCIPALES
ОСНОВНАЯ ИНФОРМАЦИЯ О ТЕХНИЧЕСКИХ ТРЕБОВАНИЯХ К СТЕНАМ И ПОЛАМ, ОБЛИЦОВАННЫМ ПЛИТКОЙ • 关于铺砖墙壁和地板的技术要求的主要信息

CLASSIFICAZIONE DELLE PIASTRELLE SMALTATE PER PAVIMENTO IN BASE ALLA LORO RESISTENZA ALL'ABRASIONE (ISO).

Questa classificazione approssimativa viene fornita solo a scopo di guida (vedere ISO 10545-7). Non dovrebbe essere utilizzata per fornire prescrizioni di prodotto in relazione a requisiti particolari.

CLASSE 0. Piastrelle in questa classe non sono consigliate per il rivestimento dei pavimenti.

CLASSE 1. Rivestimento di pavimenti in aree soggette a calpestio con scarpe a suola morbida o a piedi nudi senza sporco abrasivo (per esempio bagni e camere da letto in edifici residenziali, senza accesso diretto dall'esterno).

CLASSE 2. Rivestimento di pavimenti in aree soggette a calpestio con scarpe a suola morbida o normale con, tutt'al più piccoli quantitativi occasionali di sporco abrasivo (per esempio stanze nella zona giorno di abitazioni private, ad eccezione di cucine, ingresso ed altre zone con alto traffico), questo non si applica nel caso di calzature non normali, quali ad esempio scarpe chiodate.

CLASSE 3. Rivestimenti di pavimenti in aree soggette a calpestio con scarpe normali e con presenza frequente di piccole quantità di sporco abrasivo (per esempio cucine in edifici residenziali, sale, corridoi, logge, terrazze, balconi). Questo non si applica nel caso di calzature non normali, quali ad esempio le scarpe chiodate.

CLASSE 4. Rivestimenti di pavimenti in aree soggette a calpestio di traffico ordinario con sporco abrasivo, per cui le condizioni sono più severe di quelle riportate nella classe 3 (per esempio ingressi, cucine commerciali, hotel, negozi ed aree di vendita).

CLASSE 5. Rivestimenti di pavimenti soggetto a traffico pedonale intenso per periodi di tempo prolungati con sporco abrasivo, cosicché le condizioni sono le più severe nelle quali si possono utilizzare piastrelle smaltate per pavimento (per esempio aree pubbliche come centri commerciali, sale di aeroporti, ingressi di hotel, passaggi pedonali pubblici e applicazioni industriali).

Questa classificazione è valida per le applicazioni riportate in normali condizioni. Si dovrebbero prendere in considerazione le scarpe, il tipo di traffico e i metodi di pulizia prevedibili, ed i pavimenti dovrebbero essere adeguatamente protetti dallo sporco abrasivo all'ingresso degli edifici mediante interposizione di sistemi di pulizia delle scarpe. In casi estremi di traffico molto pesante e di abbondanza di sporco abrasivo, si possono prendere in considerazione piastrelle non smaltate per pavimento del Gruppo I.

CLASSIFICAZIONE DELLE PIASTRELLE SMALTATE PER PAVIMENTO IN BASE ALLA LORO RESISTENZA ALL'ABRASIONE (ISO)

CLASSIFICATION OF GLAZED FLOOR TILES BASED ON THEIR RESISTANCE TO ABRASION.

This classification is approximate and is given only as guidance (see ISO 10545-7). It should not be used for product specifications regarding special requirements.

CLASS 0. Tiles in this class are not recommended as flooring.

CLASS 1. Flooring in areas subject to traffic with soft-soled shoes or bare feet, without abrasive dirt (for instance, bathrooms and bedrooms in residential buildings, not directly accessed from the outside).

CLASS 2. Flooring in areas subject to traffic with soft-soled or normal shoes with, at the most, small, occasional amounts of abrasive dirt (for example, living rooms in private residences, except for kitchens, entranceways, and other high-traffic areas). This does not apply in the case of non-standard footwear, such as cleats.

CLASS 3. Flooring in areas subject to traffic with normal footwear and the frequent presence of small amounts of abrasive dirt (for example, kitchens in private residences, living rooms, corridors, patios, balconies, terraces). This does not apply in the case of non-standard footwear, such as cleats.

CLASS 4. Flooring in areas subject to ordinary traffic with abrasive dirt, in conditions more demanding than those listed for class 3 (for instance, entranceways, commercial kitchens, hotels, shops, and sales floors).

CLASS 5. Flooring subject to intense foot traffic for prolonged periods with abrasive dirt, in the most demanding conditions for which glazed floor tiles can be used (for instance, public areas such as shopping centers, airport terminals, hotel lobbies, public walkways and industrial applications).

This classification holds true for the applications listed above under normal conditions. The footwear, type of traffic, and cleaning methods that are envisaged should be taken into account, and floors should be properly protected from abrasive dirt with a doormat system at entrances to the building. In extreme cases of very heavy traffic and a large amount of abrasive dirt, the unglazed floor tiles in Group 1 could be considered.

CLASSIFICAZIONE DELLE PIASTRELLE SMALTATE PER PAVIMENTO IN BASE ALLA LORO RESISTENZA ALL'ABRASIONE (ISO)

Questa classificazione approssimativa viene fornita solo a scopo di guida (vedere ISO 10545-7). Non dovrebbe essere utilizzata per fornire prescrizioni di prodotto in relazione a requisiti particolari.

CLASSE 0. Piastrelle in questa classe non sono consigliate per il rivestimento dei pavimenti.

CLASSE 1. Rivestimento di pavimenti in aree soggette a calpestio con scarpe a suola morbida o a piedi nudi senza sporco abrasivo (per esempio bagni e camere da letto in edifici residenziali, senza accesso diretto dall'esterno).

CLASSE 2. Rivestimento di pavimenti in aree soggette a calpestio con scarpe a suola morbida o normale con, tutt'al più piccoli quantitativi occasionali di sporco abrasivo (per esempio stanze nella zona giorno di abitazioni private, ad eccezione di cucine, ingresso ed altre zone con alto traffico), questo non si applica nel caso di calzature non normali, quali ad esempio scarpe chiodate.

CLASSE 3. Rivestimenti di pavimenti in aree soggette a calpestio con scarpe normali e con presenza frequente di piccole quantità di sporco abrasivo (per esempio cucine in edifici residenziali, sale, corridoi, logge, terrazze, balconi). Questo non si applica nel caso di calzature non normali, quali ad esempio le scarpe chiodate.

CLASSE 4. Rivestimenti di pavimenti in aree soggette a calpestio di traffico ordinario con sporco abrasivo, per cui le condizioni sono più severe di quelle riportate nella classe 3 (per esempio ingressi, cucine commerciali, hotel, negozi ed aree di vendita).

CLASSE 5. Rivestimenti di pavimenti soggetto a traffico pedonale intenso per periodi di tempo prolungati con sporco abrasivo, cosicché le condizioni sono le più severe nelle quali si possono utilizzare piastrelle smaltate per pavimento (per esempio aree pubbliche come centri commerciali, sale di aeroporti, ingressi di hotel, passaggi pedonali pubblici e applicazioni industriali).

CLASSIFICAZIONE DELLE PIASTRELLE SMALTATE PER PAVIMENTO IN BASE ALLA LORO RESISTENZA ALL'ABRASIONE (ISO)

Questa classificazione è valida per le applicazioni riportate in normali condizioni. Si dovrebbero prendere in considerazione le scarpe, il tipo di traffico e i metodi di pulizia prevedibili, ed i pavimenti dovrebbero essere adeguatamente protetti dallo sporco abrasivo all'ingresso degli edifici mediante interposizione di sistemi di pulizia delle scarpe. In casi estremi di traffico molto pesante e di abbondanza di sporco abrasivo, si possono prendere in considerazione piastrelle non smaltate per pavimento del Gruppo I.

CLASSEMENT DES CARREAUX DE SOL ÉMAILLÉS EN FONCTION DE LEUR RÉSISTANCE À L'ABRASION.

Ce classement approximatif n'est donné qu'à titre indicatif (voir ISO 10545-7). En cas d'exigences particulières, il est préférable de ne pas se baser sur ce classement pour les spécifications de produit.

CLASSE 0. Il n'est pas recommandé de poser les carreaux de cette classe sur les sols.

CLASSE 1. Revêtement de sol aux endroits exposés à un passage avec chaussures à semelle souple ou à pieds nus, sans saleté abrasive (par exemple, salles de bains et chambres à coucher dans les immeubles résidentiels, sans accès direct depuis l'extérieur).

CLASSE 2. Revêtement de sol aux endroits exposés à un passage avec chaussures à semelle souple ou normale et parfois à de petites quantités de saleté abrasive (par exemple, les pièces de la zone de vie des maisons particulières, à l'exception de la cuisine, du hall d'entrée et des autres pièces à passage intense). Ceci ne vaut pas en cas de chaussures spéciales comme, par exemple, les chaussures cloutées.

CLASSE 3. Revêtement de sol aux endroits exposés à un passage avec chaussures normales et à de petites quantités fréquentes de saleté abrasive (par exemple, les cuisines des immeubles résidentiels, les salons, les couloirs, les loggias, les terrasses, les balcons). Ceci ne vaut pas en cas de chaussures spéciales comme, par exemple, les chaussures cloutées.

CLASSE 4. Revêtement de sol aux endroits exposés à un passage ordinaire et à de la saleté abrasive, dans des conditions plus sévères que celles de la classe 3 (par exemple, les halls d'entrée, les cuisines du secteur horeca, les hôtels, les boutiques et les salles de vente).

CLASSE 5. Revêtement de sol exposé à un passage intense pendant des périodes de temps prolongées et à de la saleté abrasive. Il s'agit des conditions les plus sévères dans lesquelles poser les carreaux de sol émaillés (par exemple, les endroits publics comme les centres commerciaux, les salles d'aéroport, les halls d'hôtel, les zones piétonnières publiques et les applications industrielles).

Ce classement est valable pour des applications dans des conditions normales. Les chaussures, le type de passage auquel le sol est exposé et les méthodes de nettoyage prévues devraient être prises en considération. Les sols devraient également être protégés de façon appropriée contre la saleté abrasive, en mettant à l'entrée des bâtiments des systèmes pour nettoyer les chaussures. En cas de passage très intense et en présence de très grandes quantités de saleté abrasive, le choix peut se porter sur des carreaux de sol non émaillés du groupe I.

CLASSIFICAZIONE DELLE PIASTRELLE SMALTATE PER PAVIMENTO IN BASE ALLA LORO RESISTENZA ALL'ABRASIONE (ISO)

KLASSIFIKATION VON GLASIERTEN FLIESEN FÜR BODENBELÄGE ENTSPRECHEND IHRER ABRIEBFESTIGKEIT.

Diese grobe Klassifizierung dient nur zur Orientierung (siehe ISO 10545-7). Sie sollte nicht verwendet werden, um Produktvorschriften in Bezug auf besondere Anforderungen zu liefern.

KLASSE 0. Fliesen dieser Klasse werden für Bodenbeläge nicht empfohlen.

KLASSE 1. Bodenbeläge in Bereichen, die hauptsächlich mit Schuhen mit weicher Sohle oder barfuß ohne kratzende Verschmutzung begangen werden (z. B. Bäder und Schlafzimmer in private Wohnungen ohne direkten Zugang von außen).

KLASSE 2. Bodenbeläge in Bereichen, die gelegentlich mit weichen besohnten oder normalen Schuhen mit höchstens geringen Mengen kratzender Verschmutzung begangen werden (z. B. Räume in Wohnbereichen von Häusern, mit Ausnahme von Küchen, Eingängen und ähnlichen Räumen, mit starker Trittbelastung). Dies gilt nicht für Sonderfußbekleidung, z. B. Nagelschuhe.

KLASSE 3. Bodenbeläge in Bereichen, die häufig mit normalen Schuhen mit einer geringen kratzenden Verschmutzung begangen werden (z. B. Küchen in privaten Wohnungen, Wohnzimmer, Flure, Korridore, Loggien, Terrassen, Balkone). Dies gilt nicht für Sonderfußbekleidung, z. B. Nagelschuhe.

KLASSE 4. Bodenbeläge, die regelmäßig mit kratzender Verschmutzung begangen werden, so dass die Beanspruchungen stärker sind als bei Klasse 3 (z. B. Eingangsbereiche, gewerbliche Küchen, Hotels, Geschäfte und Verkaufsräume).

KLASSE 5. Bodenbeläge, die durch starken Fußgängerverkehr über lange Zeiträume mit kratzender Verschmutzung beansprucht werden, so dass die Beanspruchungen die äußersten sind, unter denen glasierte Fliesen und Platten für Bodenbeläge verwendet werden können (z.B. öffentliche Bereiche wie Einkaufszentren, Eingangshallen auf Flughäfen, Hotelfoyers, öffentliche Fußwege und Industriebereiche).

Diese Klassifizierung gilt für die angegebenen Anwendungen unter normalen Bedingungen. Die Schuhbekleidung, die Art der Trittbelastung und mögliche Reinigungsverfahren sollten berücksichtigt werden und die Böden sollten durch Fußabtreter oder Ähnliches an den Eingängen von Gebäuden ausreichend gegen eine kratzende Verschmutzung geschützt werden. In Extremfällen mit sehr intensiver Trittbelastung und großen Mengen kratzender Verschmutzung können unglasierte Bodenfliesen aus Gruppe I in Betracht gezogen werden.

CLASSIFICAZIONE DELLE PIASTRELLE SMALTATE PER PAVIMENTO IN BASE ALLA LORO RESISTENZA ALL'ABRASIONE (ISO)

KLASSIFIKAZIJA EMALIRIVANNOJ PLOTKI ZA PLOV PO STEPENI IZNOŠOUSTOJČIVOSTI.

Данная классификация носит ориентировочный характер и дается только для справки (смотри ISO 10545-7). Она не должна использоваться в качестве предписаний к изделиям применительно к особым к ним требованиям.

KLASS 0. Относящаяся к данному классу изделий плитка не рекомендуется для покрытия полов.

KLASS 1. Покрытие полов в помещениях, где носят обувь с мягкой подошвой или ходят босиком, и где нет истирающей грязи (например, туалеты и спальни в жилых помещениях без прямого доступа к ним с улицы).

KLASS 2. Покрытие полов в помещениях, где носят обувь с мягкой или обычной подошвой при наличии очень небольшого и редко попадающего на пол количества истирающей грязи (например, комнаты в частных квартирах, за исключением кухонь, прихожих и прочих помещений с интенсивным движением). Данная категория изделий не распространяется на случаи использования обуви с шипованной подошвой.

KLASS 3. Покрытие полов в помещениях, где носят обычную обувь, на которой часто присутствуют небольшие количества истирающей грязи (например, кухни в жилых домах, гостиные, коридоры, лоджии, террасы и балконы). Данная категория изделий не распространяется на случаи использования обуви с шипованной подошвой.

KLASS 4. Покрытие полов на участках со средней интенсивностью движения и при наличии истирающей грязи. Такие условия являются более суровыми по сравнению с условиями класса 3 (например, холлы, кухни коммерческого типа, гостиницы, магазины и торговые площади).

KLASS 5. Покрытие полов с интенсивным движением людей в течение длительного времени и при наличии на обуви истирающей грязи. Такие условия являются самыми суровыми, при которых возможно использование эмалированной плитки для покрытия полов (например, такие общественные помещения, как торговые центры, залы аэропортов, холлы гостиниц, зоны пешеходного движения и участки промышленного назначения).

Данная классификация относится к применению плитки в обычных условиях. Как правило необходимо учитывать тип используемой обуви, интенсивность движения и предусматриваемые методы очистки пола. При этом на входе в здания полы должны быть должным образом защищены от абразивной грязи системами очистки обуви. В крайних случаях, при наличии очень интенсивного движения людей, можно рассматривать возможность покрытия полов неэмалированной напольной плиткой Класса I.

CLASSIFICAZIONE DELLE PIASTRELLE SMALTATE PER PAVIMENTO IN BASE ALLA LORO RESISTENZA ALL'ABRASIONE (ISO)

CLASIFICACIÓN DE LAS BALDOSAS ESMALTADAS DE PAVIMENTO SEGÚN SU RESISTENCIA A LA ABRASIÓN.

Seguidamente presentamos una clasificación aproximativa con la finalidad únicamente de servir de guía (ver ISO 10545-7). Dicha clasificación no debería utilizarse para proporcionar prescripciones de producto con relación a requisitos particulares.

CLASE 0. Las baldosas de esta clase no se aconsejan para el revestimiento de pavimentos.

CLASE 1. Revestimiento de pavimentos en zonas sometidas a pisoteo con zapatos de suela blanda o con pies descalzos sin suciedad abrasiva (por ejemplo: cuartos de baño y dormitorios de edificios residenciales, sin acceso directo del exterior).

CLASE 2. Revestimiento de pavimentos en zonas sometidas a pisoteo con zapatos de suela blanda o normal con, a lo sumo, pequeñas cantidades ocasionales de suciedad abrasiva (por ejemplo: habitaciones en los cuartos de estar de viviendas privadas, a excepción de cocinas, vestíbulos y otras zonas con tráfico elevado). No se aplica en caso de zapatos no normales, como, por ejemplo, botas claveteadas.

CLASE 3. Revestimiento de pavimentos en zonas sometidas a pisoteo con zapatos normales y con presencia frecuente de pequeñas cantidades de suciedad abrasiva (por ejemplo: cocinas de edificios residenciales, salas, pasillos, pórticos, terrazas o balcones). No se aplicará en caso de calzados no normales, como, por ejemplo, botas claveteadas.

CLASE 4. Revestimiento de pavimentos en zonas sometidas a pisoteo de tráfico ordinario con suciedad abrasiva, por lo que las condiciones son más severas que las indicadas en la clase 3 (por ejemplo: vestíbulos, cocinas de establecimientos comerciales, hoteles, tiendas y zonas de venta).

CLASE 5. Revestimiento de pavimentos sometidos a tráfico peatonal intenso durante largos periodos de tiempo con suciedad abrasiva, siendo las condiciones más severas en las que pueden utilizarse baldosas esmaltadas de pavimento (por ejemplo: zonas públicas como centros comerciales, salas de aeropuertos, vestíbulos de hoteles, pasos peatonales públicos y aplicaciones industriales).

Esta clasificación es válida para las aplicaciones realizadas en condiciones normales. Sin embargo, deberán tenerse en cuenta los zapatos, el tipo de tráfico y los métodos de limpieza previsibles. Asimismo, los pavimentos han de protegerse adecuadamente de la suciedad abrasiva interponiendo a la entrada de los edificios sistemas adecuados para la limpieza de los zapatos. En casos extremos de tráfico muy elevado y de abundancia de suciedad abrasiva, podrán tomarse en consideración las baldosas no esmaltadas de pavimento del Grupo I.

根据耐磨性划分的釉面地砖等级

这一大致划分仅供参考（参阅 ISO 10545-7）。不应用于提供与特殊需要有关的产品说明。

0级: 这一等级的瓷砖建议不要用于铺设地板。

1级: 用于铺设软底鞋或赤脚践踏、没有磨蚀性脏物的区域的地砖(例如: 民用建筑的浴室和卧室，没有从室外的直接入口)。

2级: 用于铺设承受软底鞋或普通鞋践踏、最多偶尔有少量磨蚀性脏物的区域(例如私人住宅的起居室、厨房、门口及其它使用率高的区域除外)的地砖。不适用于非普通鞋子，例如钉鞋。

3级: 用于铺设承受普通鞋子践踏并通常有少量磨蚀性脏物的区域(例如住宅中的厨房、客厅、走廊、凉廊、露台、阳台)的地砖。不适用于非普通鞋子，例如钉鞋。

4级: 用于铺设承受有磨蚀性脏物的平常使用践踏、因而情况比3级所述较严峻的区域(例如门口、商业厨房、酒店、商店和销售区域)的地砖。

5级: 用于铺设长时间承受密集行人践踏并有磨蚀性脏物、因而比可使用釉面地砖的情况较严峻的区域(例如公共地区商业中心、机场的候机大厅、酒店入口、公共人行道和工业用人行道)的地砖。

这一划分对普通情况下的应用有效。必须考虑鞋子、使用类型以及清洁方法，而且必须在建筑物入口处放置清洁鞋子的门垫之类，适当保护地面免受磨蚀性脏物磨损。在使用率极高和磨蚀性脏物极多的情况下，可以考虑使用第1组的非釉面地砖。

Elementi decorativi

DECORATIVE ELEMENTS • ELEMENTS DE DECORATION • DEKORATIONSELEMENTE • ELEMENTOS DECORATIVOS • ДЕКОРАТИВНЫЕ ЭЛЕМЕНТЫ • 装饰件

Декоративные элементы из натурального камня

Декоративные элементы из натурального камня с матовым покрытием

Типы декоративных элементов, используемых Gardenia, можно свести к следующим:
ДЕКОР ИЗ НАТУРАЛЬНОГО КАМНЯ И МРАМОРА. Используют натуральные материалы, обеспечивающие широкое разнообразие цветов, оттенков и текстур. Они чрезвычайно прочны, однако не очень хорошо сопротивляются пятнам и кислотам, характеристика, которая делает их непригодными для любого применения.

ДЕКОР ИЗ ЗОЛОТА И ГЛЯНЦА. Выполнены с использованием смальты и драгоценных материалов, нанесенных с помощью утонченной техники. Использование металлического глянца придает керамическому продукту переличатый эффект, обогащающий его перламутровыми отблесками. Декор, представляющий украшения из чистого золота, может со временем потерять оригинальный блеск, приобретая матовый цвет, характерный для старинного золота.

ОБРАБОТКИ PVD (Physical Vapour Deposition). Процесс PVD основывается на физическом принципе испарения металлов в вакуумной среде (титан, золото, платина и другие), которые в ионизированном состоянии конденсируют, образуя пленку, покрывающую обрабатываемое изделие.

ПРЕИМУЩЕСТВА ОБРАБОТКИ PVD.

Высочайшая твердость поверхности.

Наибольшее сопротивление коррозии: после 1500 часов нахождения в солевом тумане полное отсутствие повреждений поверхности (ISO 9227).

Превосходная устойчивость к царапинам и истиранию (в два раза выше по сравнению с электролитическим хромированием).

Устойчивость к воздействию растворителей, кислот, щелочей и используемых в быту составов от накипи.

Стойкость к УФ излучению: 2400 часов (UNI 9397).

ДЕКОР СО СТЕКЛЯННЫМИ УКРАШЕНИЯМИ. Ценность этого декоративного типа происходит от присутствия так называемого «эффекта кракелюра», очень изысканного и высоко ценящегося с древних времен. Неравномерное распределение стеклянных гранул в действительности придает керамическому продукту ценность ручной работы и, следовательно, высокое эстетическое содержание.

ДЕКОР РУЧНОЙ РАБОТЫ. Продукты, выполненные с применением украшений ручной работы, обладают такими характеристиками, как неровность и нерегулярность ремесленного производства, которые и являются непосредственно ценностью изделия.

ДРУГОЙ ДЕКОР. Что касается декора из других материалов, например, из алюминия, стали, стекла или других некерамических материалов, рекомендуем соблюдать нормы по укладке и особый уход для каждого типа.

Декоративные элементы из натурального камня

RACCOMANDAZIONI GENERALI.

Sulla base di quanto appena argomentato, è necessario dedicare molta attenzione sia alla posa che alla pulizia dei materiali. Tutti i pezzi speciali richiedono molta cautela nella posa e un adeguato trattamento, essendo spesso realizzati con tecniche produttive sofisticate che ne arricchiscono l'effetto estetico. Per mantenere nel tempo la bellezza e le caratteristiche del prodotto ceramico, Gardenia **si raccomanda di non utilizzare mai strumenti o detergenti abrasivi che contengano acidi e/o solventi, ma semplicemente acqua e sapone neutro**. Particolare attenzione meritano le decorazioni in pietra naturale:

- Vanno lavate esclusivamente con acqua, senza uso di getti a pressione o di detergenti che potrebbero scolorire il materiale.
- Per la lucidatura, utilizzare gli specifici prodotti a base naturale in commercio.
- Se applicate in bagni o cucine, si consiglia dopo la posa un trattamento specifico idro-oleo repellente.
- Se applicate in pavimentazioni, si consiglia di sottoporle anche a un trattamento anti-graffio.

Raccomandiamo di seguire in modo scrupoloso quanto sopra esposto poiché, in caso contrario, Gardenia declina ogni responsabilità in caso di contestazione.

I metalli preziosi utilizzati su questi decori (oro, argento, rame, lustri) hanno caratteristiche particolari:

- Instabilità del punto colore (tonalità variabile)
- Probabile ossidazione a contatto dell'aria e/o dell'umidità
- Delicatezza della superficie

POSA: Utilizzare stucchi cementizi a grana fine, senza parti grossolane abrasive (per esempio “glitter”)

Ripulire lo stucco **A FRESCO** utilizzando una spugna morbida ed avendo cura di risciacquarla spesso con acqua pulita.

Декоративные элементы из натурального камня

GENERAL GUIDELINES.

As mentioned above, particular care is necessary for both the installation and cleaning of these materials. All special trims require particular care during installation and adequate treatments, as they are often manufactured using sophisticated processes to enhance their appearance. To preserve the beauty and qualities of Gardenia ceramic products over time, never use abrasive products or detergents containing acids and/or solvents and only wash with water and neutral soap. Particular care must be taken with decorations in natural stone:

- They should be cleaned with water only, without pressurized jets or detergents that could cause the material to fade.
- For polishing, use specific, suitable natural products available on the market.
- If used in bathrooms or kitchens, we recommend a special oil/water-repellent treatment after installation.
- If used for flooring, we also recommend a scratch-proofing treatment.

Gardenia cannot be held responsible for any damage if the above precautions are not observed.

The precious metals used on these decors (gold, silver, copper, lustres) have particular features:

- Instability of the point of colour (variable tone)
- Possible oxidation in contact with the air and/or humidity
- Delicacy of the surface

COLLOCATION: Use fine-grained cement grout, without abrasive coarse parts (i.e. “glitter”) Immediately clean the grout using a soft sponge taking care to rinse often with clean water.

Декоративные элементы из натурального камня

Декоративные элементы из натурального камня с матовым покрытием

Декоративные элементы из натурального камня с матовым покрытием

采用的装饰种类可以细分如下:
天然石和天然大理石装饰。采用天然材料,具有丰富的颜色、渐变色和纹理。它们极端耐用,但不完全防污和耐酸,这些特点令它们不能适合任何应用。
金饰和闪光装饰。采用优质釉料和材料以精细技术制成。金属光的应用令陶瓷产品具有闪光效果,从而增添了珍珠母反射光。有纯金底色的装饰件随着时间的推移可能会失去原来的闪亮光泽,而变成古老黄金的典型哑暗色泽。
PVD表面处理特点 (Physical Vapour Deposition). PVD表面处理根据在真空下金属 (钛,黄金,白金等) 蒸发的物理原理,在离子状态下冷凝,在进行处理的基体上沉积而形成一层薄膜。

PVD处理的优点.

高表面硬度

最大耐蚀性: 在盐雾中暴露超过1500小时而表面没有任何改变

(ISO 9227标准)

出色的耐刮性和耐磨性 (比镀铬高两倍)

不会受溶剂、酸或碱以及家庭用除水垢产品侵蚀

承受紫外光照射不变: 2400小时 (UNI 9397标准)

玻璃底色的装饰件。这种装饰种类的优点在于具有所谓的“裂纹效果”,这种效果极度精致,从古时候起就备受欣赏。玻璃砂岩的不规则分布赋予陶瓷装饰件一种手工价值,因此它具有很高的美观效果。

手工装饰。手工装饰件具有手工制作的不规则特点,这正构成了它的自身价值。其它装饰。至于不同材料的装饰,例如铅、钢、玻璃或其它非陶瓷材料,我们建议遵循每种材料的专门施工和保养规定。

Декоративные элементы из натурального камня

Декоративные элементы из натурального камня с матовым покрытием

Декоративные элементы из натурального камня с матовым покрытием

ALLGEMEINE HINWEISE.

In Bezug auf die oben aufgeführten Angaben muss sowohl auf die Verlegung als auch auf die Reinigung bzw. Pflege der Materialien geachtet werden. Alle Formteile sind mit besonderer Vorsicht zu verlegen und einer angemessenen Behandlung zu unterziehen, da sie häufig mit hoch entwickelten Produktionstechniken realisiert werden, welche deren ästhetische Wirkung verstärken. Um die Schönheit und die Merkmale des Keramikprodukts auf lange Zeit beizubehalten, empfiehlt Gardenia niemals scheuernde Utensilien oder Reinigungsmittel zu verwenden, die Säuren und/oder Lösungsmittel enthalten, sondern ausschließlich Wasser und neutrale Seife. Besondere Aufmerksamkeit ist bei Dekoren aus Naturstein geboten:

- Sie sind ausschließlich mit Wasser zu reinigen und es darf nicht mit Wasserstrahl oder Reinigungsmittel, die zum Entfärben der Fliesen oder Platten führen könnten, gearbeitet werden.
- Zum Glanzpolieren sind die speziellen im Handel erhältlichen Produkte auf natürlicher Basis zu verwenden.

- Bei der Anwendung im Bad oder in der Küche wird nach der Verlegung eine spezielle wasser- und ölabweisende Behandlung empfohlen.

- Bei der Anwendung für Bodenbeläge wird auch eine Behandlung zur Erhöhung der Kratzfestigkeit empfohlen.

Wir weisen darauf hin, die oben aufgeführten Anweisungen genau zu befolgen, andernfalls trägt die Firma Gardenia bei eventuellen Beanstandungen keine Haftung.

Die kostbaren Metalle auf diesen Dekorationen (Gold, Silber, Kupfer, Lüster) haben unterschiedliche Eigenschaften:

- Der Farbpunkt Instabilität (veränderlich Farbtöne)
- Wahrscheinliche Oxidation in Luft und / oder Feuchtigkeitskontakt
- Feine Oberfläche

VERLEGUNG: Verwenden Sie feinkörnigen Zementkitte, ohne abschleifenden Grobenteile (zB „Glitter“).

Reinigen Sie den Kitt bevor seinem kompletten Abtrocken mit einem weichen Schwamm, den oft mit sauberem Wasser gespült werden soll.

Декоративные элементы из натурального камня

Декоративные элементы из натурального камня с матовым покрытием

Декоративные элементы из натурального камня с матовым покрытием

ОБЩИЕ РЕКОМЕНДАЦИИ.

На основе всего вышесказанного необходимо уделить особое внимание как укладке, так и очистке материалов. Все специальные изделия требуют большой осторожности при укладке и соответствующую обработку, поскольку зачастую они выполнены с применением утонченной производственной техники, которая обогащает эстетический эффект. Чтобы сохранить во времени красоту и характеристики керамического продукта, Gardenia рекомендует никогда не использовать абразивные инструменты или очистители, которые содержат кислоты и/или растворители, а пользоваться только водой и нейтральным мылом. Особого внимания требуют декоры из натурального камня:

· Их стоит мыть исключительно водой, без применения струи под давлением или моющих средств, которые могут обесцветить материал.

· Для полировки следует использовать специальные продукты на натуральной основе, имеющиеся в продаже.

· Если данные декоры применяются в ванной или на кухне, то после укладки рекомендуется специальная водо-маслооталкивающая обработка.

· Если декоры применяются на полу, рекомендуется также провести обработку против царапин.

Советуем обязательно следовать вышеперечисленным рекомендациям, в противном случае Gardenia не несет никакой ответственности в случае жалоб.

Драгоценные металлы, которые используются для производства декоративных элементов (золото,серебро,медь, металлизированный блеск), имеют специальные характеристики:

· нестабильность окраски;

· возможное окисление при контакте с воздухом и/или влагой;

· деликатность поверхности.

Укладка: использовать затирки на цементной основе, без крупных частиц (например, затирки с блеском «glitter»). Смыть затирку водой, пока не застыла, используя мягкую губку. Вода должна быть чистой.

Декоративные элементы из натурального камня

Декоративные элементы из натурального камня с матовым покрытием

Декоративные элементы из натурального камня с матовым покрытием

RECOMENDACIONES GENERALES.

Sobre la base de lo expuesto arriba, deberá prestarse mucha atención tanto a la colocación como a la limpieza de los materiales. Todas las piezas especiales necesitan mucha cautela en la colocación, así como un tratamiento adecuado, al haber sido realizadas a menudo con técnicas sofisticadas de producción que enriquecen su efecto estético. Para conseguir mantener la belleza y las características del producto cerámico a lo largo del tiempo, Gardenia les ruega que no utilicen nunca instrumentos o detergentes abrasivos que contengan ácidos y/o disolventes, sino simplemente agua y jabón neutro.

Merecen especial atención las decoraciones de piedra natural:

- Han de lavarse exclusivamente con agua, sin usar chorros a presión o detergentes que pudieran decolorar el material.

- Para el lustrado, utilizar los productos específicos de base natural existentes en el mercado.
- Si se aplican en cuartos de baño o cocinas, se aconseja efectuar tras la colocación un tratamiento específico repelente al agua y al aceite.
- Si se aplican en pavimentaciones, se aconseja someterlas también a un tratamiento de resistencia a los arañazos.

Recomendamos seguir escrupulosamente todo lo expuesto arriba, ya que, de lo contrario, Gardenia declina toda responsabilidad en caso de contestación.

Los metales valiosos utilizados sobre estas decoraciones (oro, plata, cobre, lustres) tienen características especiales:

- Inestabilidad del punto color (tonalidad variable)
- Probable oxidación a contacto con el aire y/o la humedad
- Delicadeza de la superficie

COLOCACION: Utilizar estucos de yeso de grano fino, sin partes ásperas abrasivas (por ejemplo “Glitter”)

Limpiar el estuco A FRESCO utilizando una esponja suave y procurando arrastrar amenudo con agua limpia.

Декоративные элементы из натурального камня

Декоративные элементы из натурального камня с матовым покрытием

Декоративные элементы из натурального камня с матовым покрытием

Декоративные элементы из натурального камня

Декоративные элементы из натурального камня с матовым покрытием

Декоративные элементы из натурального камня с матовым покрытием

Декоративные элементы из натурального камня

Декоративные элементы из натурального камня с матовым покрытием

Декоративные элементы из натурального камня с матовым покрытием

Декоративные элементы из натурального камня

Декоративные элементы из натурального камня с матовым покрытием

Декоративные элементы из натурального камня с матовым покрытием

Декоративные элементы из натурального камня

Декоративные элементы из натурального камня с матовым покрытием

Декоративные элементы из натурального камня с матовым покрытием

Декоративные элементы из натурального камня

Декоративные элементы из натурального камня с матовым покрытием

Декоративные элементы из натурального камня с матовым покрытием

Декоративные элементы из натурального камня

Декоративные элементы из натурального камня с матовым покрытием

Декоративные элементы из натурального камня с матовым покрытием

Декоративные элементы из натурального камня

Декоративные элементы из натурального камня с матовым покрытием

Декоративные элементы из натурального камня с матовым покрытием

Декоративные элементы из натурального камня

Декоративные элементы из натурального камня с матовым покрытием

Декоративные элементы из натурального камня с матовым покрытием

Декоративные элементы из натурального камня

Декоративные элементы из натурального камня с матовым покрытием

Декоративные элементы из натурального камня с матовым покрытием

Декоративные элементы из натурального камня

Декоративные элементы из натурального камня с матовым покрытием

Декоративные элементы из натурального камня с матовым покрытием

Декоративные элементы из натурального камня

Декоративные элементы из натурального камня с матовым покрытием

Декоративные элементы из натурального камня с матовым покрытием

Декоративные элементы из натурального камня

Декоративные элементы из натурального камня с матовым покрытием

Декоративные элементы из натурального камня с матовым покрытием

Avvertenze per l’installazione

INSTALLATION SPECIFICATIONS • INSTRUCTION DE POSE • VERLEGUNGSANWEISUNGEN • ADVERTENCIAS PARA LA COLOCACION • МЕРЫ ПРЕДОСТОРОЖНОСТИ ПРИ УКЛАДКЕ • 安装警告

Spugna per la pulizia

Durante la posa in opera, è necessario procedere a una tempestiva ed accurata pulizia con acqua dei residui di colla e stucco, al fine di evitare incrostazioni la cui rimozione potrebbe rivelarsi difficoltosa. **Per questa operazione si raccomanda di non usare mai spugne, detersivi, paste o sostanze abrasive in genere che potrebbero compromettere le caratteristiche estetiche del prodotto. Qualora si rendesse indispensabile l'utilizzo di detersgenti contenenti acidi per l'asportazione dal pavimento di residui di stucchi e/o colle, si raccomanda di risciacquare accuratamente con acqua dopo l'applicazione, procedendo quindi ad asciugatura. Di norma, i produttori consigliano di provare i loro detersgenti su una piccola porzione nascosta del pavimento o del rivestimento prima di utilizzarli su tutta la superficie da trattare.** Dopo la pulizia, si consiglia un'accurata protezione del pavimento posato, specie nel caso si tratti di gres porcellanato levigato o lappato. Durante i lavori di posa in opera, è bene proteggere le superfici delle lastre da eventuali abrasioni.

Piastrella di gres porcellanato

NOTA BENE. All’atto della posa prelevare piastrelle alternativamente da diverse scatole. Controllare, prima della posa, tonalità, calibro e scelta. **Non si accettano reclami relativi a materiale già posato.**

Per una posa eseguita a regola d’arte è richiesta, in generale, l’osservanza dei seguenti criteri:

1 - resistenze adeguate del sottofondo;

2 - rispetto dei tempi di maturazione del massetto;

3 - posa in ambienti di sole civili abitazioni. Applicazioni diverse dovranno essere sottoposte a verifica di Gardenia Orchidea;

4 - rispetto degli eventuali giunti strutturali presenti;

5 - realizzazione di giunto elastico perimetrale, per ogni elemento in elevazione, con limitazione delle superfici continue a non oltre 50-60 m² (25-30 m² in presenza di grandi vetrate);

6 - utilizzo di opportuno adesivo di classe C2 (per interno) o C2E (per esterno) secondo EN 12004, utilizzando la tecnica della doppia spalmatura;

7 - utilizzo di idoneo stucco avendo cura di effettuare prove preventive di pulibilità in caso di stuccature a contrasto;

8 - all’atto della posa prelevare piastrelle alternativamente da diverse scatole;

9 - controllare, prima della posa, tonalità, calibro e scelta;

10 - posa sfalsata mai oltre i 20 cm.

Spugna per la pulizia

Piastrella di gres porcellanato

Spugna per la pulizia

Piastrella di gres porcellanato

Spugna per la pulizia

Piastrella di gres porcellanato

Spugna per la pulizia

Piastrella di gres porcellanato

Spugna per la pulizia

Piastrella di gres porcellanato

Spugna per la pulizia

Piastrella di gres porcellanato

Spugna per la pulizia

Piastrella di gres porcellanato

Spugna per la pulizia

Piastrella di gres porcellanato

Spugna per la pulizia

Piastrella di gres porcellanato

Spugna per la pulizia

Piastrella di gres porcellanato

Spugna per la pulizia

Piastrella di gres porcellanato

Spugna per la pulizia

Piastrella di gres porcellanato

Spugna per la pulizia

Piastrella di gres porcellanato

Spugna per la pulizia

Piastrella di gres porcellanato

Spugna per la pulizia

Piastrella di gres porcellanato

Spugna per la pulizia

Piastrella di gres porcellanato

Spugna per la pulizia

Piastrella di gres porcellanato

Spugna per la pulizia

Piastrella di gres porcellanato

Spugna per la pulizia

Piastrella di gres porcellanato

Spugna per la pulizia

Piastrella di gres porcellanato

Spugna per la pulizia

Piastrella di gres porcellanato

Spugna per la pulizia

Spugna per la pulizia

Piastrella di gres porcellanato

Spugna per la pulizia

Piastrella di gres porcellanato

Spugna per la pulizia

Piastrella di gres porcellanato

Spugna per la pulizia

Piastrella di gres porcellanato

Spugna per la pulizia

Piastrella di gres porcellanato

Spugna per la pulizia

Piastrella di gres porcellanato

Spugna per la pulizia

Piastrella di gres porcellanato

Spugna per la pulizia

Piastrella di gres porcellanato

Spugna per la pulizia

Piastrella di gres porcellanato

Spugna per la pulizia

Piastrella di gres porcellanato

Spugna per la pulizia

Piastrella di gres porcellanato

Spugna per la pulizia

Piastrella di gres porcellanato

Spugna per la pulizia

Piastrella di gres porcellanato

Spugna per la pulizia

Piastrella di gres porcellanato

Spugna per la pulizia

Piastrella di gres porcellanato

Spugna per la pulizia

Piastrella di gres porcellanato

Spugna per la pulizia

Piastrella di gres porcellanato

Spugna per la pulizia

Piastrella di gres porcellanato

Spugna per la pulizia

Piastrella di gres porcellanato

Spugna per la pulizia

Piastrella di gres porcellanato

Spugna per la pulizia

Piastrella di gres porcellanato

Spugna per la pulizia

Piastrella di gres porcellanato

Spugna per la pulizia

Piastrella di gres porcellanato

Spugna per la pulizia

Piastrella di gres porcellanato

Spugna per la pulizia

Piastrella di gres porcellanato

Spugna per la pulizia

Piastrella di gres porcellanato

Spugna per la pulizia

Piastrella di gres porcellanato

Spugna per la pulizia

Piastrella di gres porcellanato

Spugna per la pulizia

Piastrella di gres porcellanato

Spugna per la pulizia

Piastrella di gres porcellanato

Spugna per la pulizia

Piastrella di gres porcellanato

Spugna per la pulizia

Piastrella di gres porcellanato

Spugna per la pulizia

Piastrella di gres porcellanato

Spugna per la pulizia

Piastrella di gres porcellanato

Spugna per la pulizia

Piastrella di gres porcellanato

Spugna per la pulizia

Piastrella di gres porcellanato

Spugna per la pulizia

Piastrella di gres porcellanato

Spugna per la pulizia

Piastrella di gres porcellanato

Spugna per la pulizia

Piastrella di gres porcellanato

Spugna per la pulizia

Piastrella di gres porcellanato

Spugna per la pulizia

Piastrella di gres porcellanato

Spugna per la pulizia

Piastrella di gres porcellanato

Spugna per la pulizia

Piastrella di gres porcellanato

Spugna per la pulizia

Piastrella di gres porcellanato

Spugna per la pulizia

Piastrella di gres porcellanato

Spugna per la pulizia

Piastrella di gres porcellanato

Spugna per la pulizia

Piastrella di gres porcellanato

Spugna per la pulizia

Piastrella di gres porcellanato

Spugna per la pulizia

Piastrella di gres porcellanato

Spugna per la pulizia

Piastrella di gres porcellanato

Spugna per la pulizia

Piastrella di gres porcellanato

Spugna per la pulizia

Piastrella di gres porcellanato

Spugna per la pulizia

Piastrella di gres porcellanato

Spugna per la pulizia

Piastrella di gres porcellanato

Spugna per la pulizia

Piastrella di gres porcellanato

Spugna per la pulizia

Piastrella di gres porcellanato

Spugna per la pulizia

Piastrella di gres porcellanato

Spugna per la pulizia

Piastrella di gres porcellanato

Spugna per la pulizia

Piastrella di gres porcellanato

Spugna per la pulizia

Piastrella di gres porcellanato

Spugna per la pulizia

Piastrella di gres porcellanato

Spugna per la pulizia

Piastrella di gres porcellanato

Spugna per la pulizia

Piastrella di gres porcellanato

Spugna per la pulizia

Piastrella di gres porcellanato

Spugna per la pulizia

Piastrella di gres porcellanato

Spugna per la pulizia

Piastrella di gres porcellanato

Spugna per la pulizia

Piastrella di gres porcellanato

Spugna per la pulizia

Piastrella di gres porcellanato

Spugna per la pulizia

Piastrella di gres porcellanato

Spugna per la pulizia

Piastrella di gres porcellanato

Spugna per la pulizia

Piastrella di gres porcellanato

Spugna per la pulizia

Piastrella di gres porcellanato

Spugna per la pulizia

Piastrella di gres porcellanato

Spugna per la pulizia

Piastrella di gres porcellanato

Spugna per la pulizia

Piastrella di gres porcellanato

Spugna per la pulizia

Piastrella di gres porcellanato

Spugna per la pulizia

Piastrella di gres porcellanato

Spugna per la pulizia

Piastrella di gres porcellanato

Spugna per la pulizia

Piastrella di gres porcellanato

Spugna per la pulizia

Piastrella di gres porcellanato

Spugna per la pulizia

Piastrella di gres porcellanato

Spugna per la pulizia

Piastrella di gres porcellanato

Spugna per la pulizia

Piastrella di gres porcellanato

Spugna per la pulizia

Piastrella di gres porcellanato

Spugna per la pulizia

Piastrella di gres porcellanato

Spugna per la pulizia

Piastrella di gres porcellanato

Spugna per la pulizia

Piastrella di gres porcellanato

Spugna per la pulizia

Piastrella di gres porcellanato

Spugna per la pulizia

Piastrella di gres porcellanato

Spugna per la pulizia

Piastrella di gres porcellanato

Spugna per la pulizia

Piastrella di gres porcellanato

Spugna per la pulizia

Piastrella di gres porcellanato

Spugna per la pulizia

Piastrella di gres porcellanato

Spugna per la pulizia

Piastrella di gres porcellanato

Spugna per la pulizia

Piastrella di gres porcellanato

Spugna per la pulizia

Piastrella di gres porcellanato

Spugna per la pulizia

Piastrella di gres porcellanato

Spugna per la pulizia

Piastrella di gres porcellanato

Spugna per la pulizia

Piastrella di gres porcellanato

Spugna per la pulizia

Piastrella di gres porcellanato

Spugna per la pulizia

Piastrella di gres porcellanato

Spugna per la pulizia

Piastrella di gres porcellanato

Spugna per la pulizia

Piastrella di gres porcellanato

Spugna per la pulizia

Piastrella di gres porcellanato

Spugna per la pulizia

Piastrella di gres porcellanato

Spugna per la pulizia

Piastrella di gres porcellanato

Spugna per la pulizia

Piastrella di gres porcellanato

Spugna per la pulizia

Piastrella di gres porcellanato

Spugna per la pulizia

Piastrella di gres porcellanato

Spugna per la pulizia

Spugna per la pulizia

Piastrella di gres porcellanato

Spugna per la pulizia

Piastrella di gres porcellanato

Spugna per la pulizia

Piastrella di gres porcellanato

Spugna per la pulizia

Piastrella di gres porcellanato

Spugna per la pulizia

Piastrella di gres porcellanato

Spugna per la pulizia

Piastrella di gres porcellanato

Spugna per la pulizia

Piastrella di gres porcellanato

Spugna per la pulizia

Piastrella di gres porcellanato

Spugna per la pulizia

Piastrella di gres porcellanato

Spugna per la pulizia

Piastrella di gres porcellanato

Spugna per la pulizia

Avvertenze per l'installazione di prodotti rettificati

INSTALLATION NOTES FOR RECTIFIED TILES • RECOMMANDATIONS POUR LA POSE DE CARRELAGES RECTIFIES • HINWEISE FÜR DIE VERLEGUNG REKTIFIZierter PRODUKTE
ADVERTENCIAS PARA LA COLOCACION DE PRODUCTOS RECTIFICADOS • РЕКОМЕНДАЦИИ ПО УКЛАДКЕ РЕКТИФИЦИРОВАННОЙ ПРОДУКЦИИ • 磨边产品的安装警告

Il prodotto rettificato consente anche di ottenere una superficie in cui la giunzione fra una lastra e l'altra è appena percettibile. L'elevata durezza e ortogonalità del materiale impongono però alcune importanti avvertenze durante le operazioni di posa.

Rectified products also enable to obtain surfaces where joints are hardly perceptible. The high hardness of this material and the perfect orthogonality of the tiles demand the adoption of some important precautions during the laying operations.

Mit rektifizierten Produkten lassen sich Oberflächen mit kaum sichtbaren Verbindungsstellen zwischen einer und der anderen Platte erzielen. Die hohe Härte und Rechtwinkligkeit des Materials zwingen jedoch dazu, bei der Verlegung einige wichtige Hinweise zu beachten.

Ректифицированный продукт позволяет также получить поверхность, где шов между плитами почти не заметен. Повышенная прочность и ортогональность материала предписывают, тем не менее, некоторые важные меры предосторожности во время укладки.

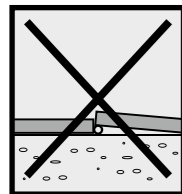

VERIFICARE LA PERFETTA PULIZIA E PLANARITÀ DEL SOTTOFONDO SU CUI ANDRÀ POSATO IL PRODOTTO.

Check that the surface on which the tiles will be installed is absolutely flat and clean. Vérifier la parfaite propreté et planarité de la sous-couche sur laquelle le produit sera posé. Prüfen, dass der Estrich, auf dem die Platten verlegt werden, perfekt sauber und ebenflächig ist. Comprobar que la solera sobre la que se coloca el producto, sea perfectamente limpia y plana.

Обеспечить абсолютную чистоту и ровность основания, на которое будет уложен продукт.

检查将铺设产品的基底是否清洁和平滑。

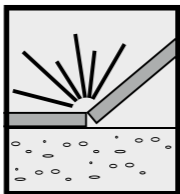

EVITARE GLI URTI DURANTE L'APPLICAZIONE DEL PRODOTTO, PER NON PROVOCARE LA SCHEGGIATURA DEGLI SPIGOLI SUPERIORI DELLA PIASTRELLA.

Take care not to knock tiles during laying, as this may chip their top edges. Lors de la pose, éviter d'entrechoquer les carreaux afin de ne pas les ébrécher à la hauteur des arêtes supérieures.

Beim Auflegen der Platten Stöße vermeiden, damit die oberen Plattenkanten nicht splintern. Evite los golpes durante la colocación del producto, para no causar el astillado de los cantos superiores del azulejo.

Избегайте ударов во время укладки продукта, чтобы не вызвать скол верхних углов плитки.

在铺设产品时应避免碰撞，以免导致瓷砖上面的边角破裂。

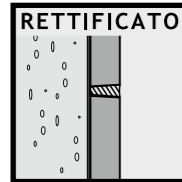
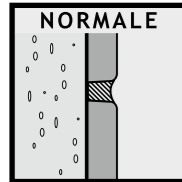

È CONSIGLIATA UNA DIMENSIONE DELLA FUGA TALE DA PERMETTERE ALLO STUCCO DI RAGGIUNGERE IL SOTTOFONDO (2MM MINIMO). È NECESSARIO L'UTILIZZO DI STUCCHI SPECIFICI PER IL MATERIALE INSTALLATO (AD ES., GRES PORCELLANATO: ASSORBIMENTO ACQUA < 0,1%) INSTALLATI CON FUGA MINIMA (CONSULTARE LE AZIENDE PRODUTTRICI DI STUCCHI).

We recommend a joint size that will allow the grout to reach the sub-base (minimum 2 mm). The grout must be specifically intended for the material to be laid (for example, porcelain stoneware: water absorption < 0.1%) with a minimum gap size (consult the grout manufacturer).

Nous recommandons de dimensionner le joint de façon à permettre au mortier d'atteindre le support (2 mm minimum). Il est indispensable d'avoir recours à des mortiers spécialement adaptés au matériel posé (par ex. : le grès cérame = absorption d'eau < 0,1%) à joints réduits (s'adresser aux fabricants de mortiers).

Es wird ein Fugenabstand empfohlen, der es der Fugenmasse erlaubt den Untergrund zu erreichen (mind. 2 mm). Die Verwendung von speziellen Fugenmassen für das installierte Material ist notwendig (z.B. Feinsteinzeug: Wasseraufnahme < 0,1%), die mit einer minimalen Fuge installiert werden (den Hersteller der Fugenmasse konsultieren).

Se aconseja mantener una dimensión de la junta que permita que el material de rejuntado alcance el sustrato (2 mm como mínimo). Han de utilizarse materiales de rejuntado específicos para el material colocado (por ej. gres porcelánico: absorción de agua < 0,1%) y aplicarse con junta pequeña (consultar a los fabricantes de materiales de rejuntado).

Рекомендуется такой размер шва, чтобы позволить штукатурке достичь основания (минимум 2 мм). Необходимо использование специальной штукатурки для уложенного материала (например, керамогранит: водопоглощение < 0,1%), нанесенной с минимальным швом (обратиться к компаниям-производителям штукатурки).

建议缝隙的尺寸应允许灰泥到达基底(至少2mm)。必须使用安装材料(例如：细瓷砖吸水率< 0,1%)的专用灰泥，并留下最小缝隙(向灰泥生产公司查询)。

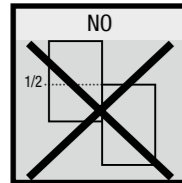
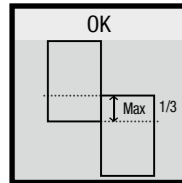

VISTE LE CARATTERISTICHE DEL PRODOTTO, NEL CASO DI POSA SFALSATA SI CONSIGLIA DI NON ECCEDERE NELLA SFALSATURA DI OLTRE 1/3 DELLA LUNGHEZZA DELLA MATTONELLA.

Due to the particular product characteristics, if a staggered layout is chosen, the tiles should not extend beyond the adjacent ones by more than 1/3 of the length of the tile.

Pour la pose à coupe de pierre, il est conseillé de ne pas décaler les carreaux de plus de 1/3 de la longueur en raison de leurs caractéristiques.

Aufgrund der Eigenschaften des Produkts wird im Fall eines versetzten Verlegemusters empfohlen, beim Versetzen 1/3 der Fliesenlänge nicht zu überschreiten.

Vistas las características del producto, en caso de colocación escalonada, se aconseja no exceder en el escalonamiento más de 1/3 de la longitud de la baldosa.

Учитывая характеристики продукта, в случае смещенной укладки рекомендуется не превышать смещение на расстояние, превышающее 1/3 длины плитки.

出于产品特性的原因，在交错施工时，建议交错不要超过铺地砖长度的三分之一。

PER UNA POSA A REGOLA D'ARTE SI RACCOMANDA L'USO DEI DISTANZIATORI AUTOLIVELLANTI.

For perfect results, we recommend that you use self-levelling spacers when laying the tiles. Pour une pose selon les règles de l'art, l'utilisation des écarteurs autonivelants est préconisée. Für eine Verlegung nach den Regeln der Kunst empfehlen wir die Verwendung von selbstnivellierenden Distanzstücken. Para una colocación según reglas del buen arte se recomienda utilizar separadores autonivelantes. Для правильной укладки рекомендуется использование самовыравнивающихся распорных элементов. 标准的铺贴建议使用找平垫。

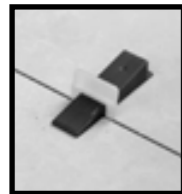

ESEMPIO DI SISTEMA A CONO: CONSIGLIATO PER PAVIMENTI E RIVESTIMENTI CON SUPERFICIE NATURALE (NON ADATTO A PRODOTTI LAPPATI, LEVIGATI E/O LUCIDI IN GENERE).

Example of a tile levelling wedge system: Recommended for floor and wall tiles with a natural surface (unsuitable for products that are lapped, polished and/or that have glossy surfaces in general).

Exemple d'un système à cône : conseillé pour sols et revêtements avec surface naturelle (non indiqué pour des produits rodés, polis et/ou brillants en général).

Beispiel für das Konus-System: Empfohlen für Böden und Wandverkleidungen mit natürlicher Oberfläche (nicht geeignet für gelappte, geschliffene und/oder auf Hochglanz polierte Produkte im Allgemeinen).

Ejemplo de sistema de cono: se aconseja para suelos y revestimientos con superficies naturales (no se adapta a productos pulidos, cepillados y/o brillantes en general).

Пример системы в форме конуса: рекомендуется для полов и покрытий натурального вида (не подходит для полированных, шлифованных или блестящих изделий в целом).

例如楔形找平系统：建议用于亚光，自然表面的墙砖及地砖（不适用于抛光，半抛或者亮面产品）。



ESEMPIO DI SISTEMA A TIRANTI: CONSIGLIATO PER PAVIMENTI E RIVESTIMENTI LAPPATI, LEVIGATI E CON SUPERFICIE LUCIDA.

Example of a strap system: recommended for floor and wall tiles that are lapped, polished and that have a glossy surface.

Exemple d'un système à tirants : conseillé pour sols et revêtements rodés, polis et avec surface brillante.

Beispiel für das System mit Zugstreben: Empfohlen für gelappte, geschliffene und auf Hochglanz polierte Böden und Wandverkleidungen.

Ejemplo de sistema con tirantes: se aconseja para suelos y revestimientos pulidos, cepillados y con superficie brillante.

Пример системы с растяжками: рекомендуется для полированных, шлифованных или блестящих поверхностей полов и покрытий.

例如拉杆型系统:建议用于半抛，全抛，亮面的墙砖及地砖。

Para mayor información, <http://www.gardenia.it/video/> colocación de formatos grandes.

Дополнительную информацию см. по адресу <http://www.gardenia.it/video/> укладка больших форматов.

更多大规格的铺贴信息请浏览网站 <http://www.gardenia.it/video/>.

PER ULTERIORI APPROFONDIMENTI, <http://www.gardenia.it/video/> posa grandi formati.

For further information, <http://www.gardenia.it/video/> laying large slabs.

En cas d'approfondissements supplémentaires, <http://www.gardenia.it/video/> pose de grands formats.

Für weitere Informationen, <http://www.gardenia.it/video/> Verlegen von großen Formaten.

Le grandi lastre

BIG SLABS • GRANDES PLAQUES • GROSSFORMATE • GRANDES PLACAS • БОЛЬШИХ ПЛИТ • 大板

ACCORGIMENTI SPECIFICI PER L'APPLICAZIONE DELLE GRANDI LASTRE.

PRECAUTIONS FOR BIG SLABS APPLICATIONS.

PRECAUTIONS SPECIFIQUES POUR LA POSE DES GRANDES PLAQUES.

SPEZIFISCHE ANWEISUNGEN ZUR NUTZUNG DER GROSSFORMATE.

PRECAUCIONES ESPECIFICAS PARA LA APLICACION DE LAS GRANDES PLACAS.

СПЕЦИАЛЬНЫЕ ПРЕДОСТОРОЖНОСТИ ДЛЯ УКЛАДКИ БОЛЬШИХ ПЛИТ.

米厚度陶瓷大板应用方法

Gardenia Orchidea raccomanda l'utilizzo delle grandi lastre in spessore 6,5 mm per le sole applicazioni in ambito residenziale, commerciale a traffico leggero e comunque in contesti ove non vi sia passaggio di carichi puntuali pesanti o transito di carrelli a ruote dure.

Gardenia Orchidea recommends the use of 6,5 mm thick large slabs only for residential settings, commercial premises with light traffic or areas not subject to heavy loads or the passage of carriages with hard wheels.

Gardenia Orchidea recommande d'utiliser les grandes plaques en 6,5 mm d'épaisseur uniquement pour les applications résidentielles et commerciales à fréquence de passage réduite, ainsi que dans des contextes non marqués par le passage même occasionnel de charges lourdes ou de chariots à roues dures.

Gardenia Orchidea empfiehlt die Nutzung großer Platten mit 6,5 mm Stärke für eine ausschließliche Anwendung in Wohnanlagen, Geschäften mit geringem Verkehr und auf jeden Fall in Umgebungen, wo keine schwere Fahrzeuge oder Laufwagen mit harten Rädern regelmäßig durchfahren.

Gardenia Orchidea aconseja utilizar las placas grandes de 6,5 mm de espesor sólo para aplicaciones residenciales y comerciales de tránsito ligero pero siempre en contextos en los que no transiten cargas concentradas o carretillas de ruedas duras.

Gardenia Orchidea рекомендует использовать большие форматы толщиной 6,5 мм только для частных жилых проектов или коммерческих с небольшой проходимостью и без использования тяжелой колесной техники.

Gardenia Orchidea公司建议仅在住宅、交通流量小的商业场所以及无论如何都没有重负荷或硬轮手推车通过的环境等应用中使用6.5毫米厚的大板材。

MOVIMENTAZIONE

HANDLING

MANUTENTION

HANDHABUNG UND TRANSPORT

TRANSPORTE

ПЕРЕМЕЩЕНИЕ

搬运

Ove possibile si consiglia l'utilizzo di elevatori meccanici per la consegna al piano delle lastre.

Where possible, mechanical lifting systems should be used for delivering slabs above the ground floor.

Lorsque cela est possible, il est conseillé d'utiliser des monte-charges mécaniques pour la livraison du carrelage à l'étage.

Wann immer möglich, empfehlen wir die Verwendung von mechanischen Hebezeugen für das Anheben und die Beförderung der Platten auf die jeweilige Etage.

Cuando es posible, se recomienda utilizar elevadores mecánicos para llevar las placas a la planta correspondiente.

По возможности рекомендуется применение механических подъемников для доставки плит на этажи.

我们建议使用机械升降设备进行大板在楼层间的搬运

La movimentazione al piano può essere gestita con l'ausilio di un telaio provvisto di ventose per conferire una maggiore stabilità alla lastra.

Handling the slabs on the floor can be managed with the aid of a frame fitted with suction cups to make the slabs more stable.

La manutention à l'étage peut s'effectuer avec un châssis équipé de ventouses pour assurer une plus grande stabilité de la plaque.

Das Anheben und die Beförderung auf die Etage kann mit Hilfe eines Rahmens mit Saugnapfen erfolgen, um so den Platten mehr Stabilität zu verleihen.

El transporte en la planta puede realizarse con un bastidor dotado de ventosas, para dar una mayor estabilidad y evitar deformaciones de la placa.

При подъеме плит на этажи для большей стабильности можно использовать раму с присосками.

楼层间的运输可以使用带有吸盘的辅助框架来增加稳定性

Eventualmente si possono utilizzare apposite ventose idonee per la movimentazione manuale.

The appropriate suction cups may be used for manual handling.

Si nécessaire, il est possible d'utiliser des ventouses spécialement conçues pour la manutention manuelle.

Unter Umständen können auch geeignete Saugheber für die manuelle Handhabung verwendet werden.

También es posible utilizar ventosas específicas para la manipulación manual.

При необходимости можно использовать соответствующие присоски для перемещения плит вручную.

如果需要可以使用合适的吸盘来手动搬运

Per spostamenti in ampie superfici è anche possibile utilizzare un carrello per il trasporto delle lastre.

For moving the slabs over large surfaces, a forklift can be used.

Pour les déplacements sur grandes surfaces, il est également possible d'utiliser un chariot pour le transport des plaques.

Bei großen Flächen kann auch ein Wagen für den Plattentransport verwendet werden.

Para el desplazamiento en una superficie extensa, también es posible utilizar un carro para el transporte de placas.

перемещении на большое расстояние можно также воспользоваться автопогрузчиком для перевозки плит.

在平层间运输可与使用推车运输大板

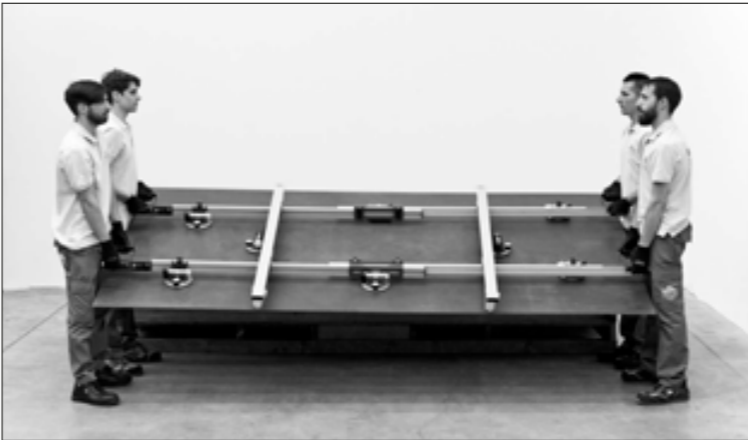

Le grandi lastre

BIG SLABS • GRANDES PLAQUES • GROSSFORMATE • GRANDES PLACAS • БОЛЬШИХ ПЛИТ • 大板

TAGLIO
CUTTING
COUPE
ZUSCHNITT
CORTE
РЕЗКА
切割

Si raccomanda di effettuare le operazioni di taglio sopra ad un piano perfettamente stabile e planare. Cutting operations should be carried out on a perfectly stable, flat surface. Il est recommandé d'effectuer les opérations de découpe sur un plan de travail parfaitement stable et plat. Es wird empfohlen, den Zuschnitt auf einer vollkommen ebenen und stabilen Oberfläche vorzunehmen. Se recomienda realizar los cortes sobre una superficie perfectamente estable y plana. Рекомендуется выполнять операции обрезки на ровной и устойчивой рабочей поверхности. 切割操作应在完全稳定，平整的平面上进行。

Si consiglia l'utilizzo di una guida di taglio provvista di utensile con la punta diamantata. A cutting guide fitted with a diamond tip tool is recommended. Il est conseillé d'utiliser un guide coupe équipé d'un outil à pointe diamantée. Es wird die Verwendung einer Schneidföhrung mit einem Werkzeug mit Diamantspitze empfohlen. Se recomienda utilizar una guía de corte dotada de broca diamantada. При обрезке рекомендуется пользоваться направляющей, оснащенной алмазным резакoм. 建议使用带有金刚石尖端的具有切割导轨的工具

Per ottenere il taglio, evitando la rottura del materiale, si consiglia l'utilizzo di apposite pinze troncatrici. To cut the slab without breaking the material, the appropriate shears should be used. Pour effectuer la coupe sans briser le matériel, utiliser des cisailles adaptées. Für den Zuschnitt wird die Verwendung einer speziellen Schneidzange empfohlen, um den Bruch des Materials zu verhindern. Para realizar el corte, sin romper el material, es aconsejable utilizar las pinzas cortadoras correspondientes. Для обрезки, во избежание раскалывания плит, рекомендуется пользоваться специальными отрезными клещами. 为了在切割时避免损坏，建议使用带有夹具的锯

È consigliato anche il taglio delle lastre tramite sega a secco oppure ad acqua con disco diamantato. The slabs can also be cut with a dry saw or wet saw with a diamond wheel cutter. Il est également recommandé de découper les plaques avec une scie de coupe à sec ou à eau avec disque diamanté. Auch der Zuschnitt der Platten mit einer Säge mit Nass- oder Trockenlauf oder einer Diamantsäge wird empfohlen. También es aconsejable cortar las placas con una amoladora con disco de diamante corte seco o húmedo. Также рекомендуется выполнять обрезку плит сухим резакoм или влажным методом с использованием алмазного диска. 大板的切割建议使用带有金刚盘的干或者湿锯

Per tagli a L o interni alla lastra si raccomanda la realizzazione di fori in corrispondenza dei vertici per evitare che la superficie si danneggi con la lama del flessibile. For L-shaped cuts or cuts inside the slab, holes should be bored at the vertices to prevent the blade of the cutting disk damaging the surface. Pour des coupes à angle droit ou internes, il est recommandé de percer des trous au droit de la plaque pour éviter d'endommager sa surface avec la lame de l'instrument. Für L-förmige Zuschnitte der Platte wird empfohlen, zunächst Löcher an den Eckpunkten anzubringen, um zu verhindern, dass die Oberfläche durch die Klinge des Trennschleifers beschädigt wird. Para cortes en L o en el interior de la placa, es recomendable hacer taladros en correspondencia de los vértices, para evitar que la superficie se dañe con el disco de la amoladora angular. При выполнении фигурной обрезки или внутренних прорезей, рекомендуется сделать отверстия в точках, соответствующих верхним углам, во избежание повреждения поверхности плит гибким резакoм. 为了切割L型或者挖孔，建议在顶点钻孔以避免切割盘破坏大板的表面

Per realizzare fori circolari sulle lastre si raccomanda di utilizzare una fresa diamantata con il diametro desiderato e di bagnare costantemente al superficie. To bore cylindrical holes on the slabs, a diamond cutting tool of the desired diameter should be used, and the surface should be kept wet constantly. Pour percer des trous circulaires sur les plaques, utiliser une fraise diamantée au diamètre voulu et en humidifier constamment la surface. Um zylindrische Bohrungen an der Platte anzubringen, wird die Verwendung einer Diamantfräse mit dem gewünschten Durchmesser empfohlen, dabei sollte die Oberfläche konstant mit Wasser benetzt werden. Para hacer perforaciones redondas en las placas es aconsejable utilizar una corona diamantada con el diámetro deseado y mojar constantemente la superficie. Для выполнения цилиндрических отверстий в плитах, рекомендуется использовать алмазную фрезу требуемого диаметра, обеспечивая постоянное увлажнение поверхности. 在大板上开圆孔，建议使用所需直径的金刚石切割工具并一直保持表面的湿润

Per realizzare fori circolari sulle lastre si raccomanda di utilizzare una fresa diamantata con il diametro desiderato e di bagnare costantemente al superficie. To bore cylindrical holes on the slabs, a diamond cutting tool of the desired diameter should be used, and the surface should be kept wet constantly. Pour percer des trous circulaires sur les plaques, utiliser une fraise diamantée au diamètre voulu et en humidifier constamment la surface. Um zylindrische Bohrungen an der Platte anzubringen, wird die Verwendung einer Diamantfräse mit dem gewünschten Durchmesser empfohlen, dabei sollte die Oberfläche konstant mit Wasser benetzt werden. Para hacer perforaciones redondas en las placas es aconsejable utilizar una corona diamantada con el diámetro deseado y mojar constantemente la superficie. Для выполнения цилиндрических отверстий в плитах, рекомендуется использовать алмазную фрезу требуемого диаметра, обеспечивая постоянное увлажнение поверхности. 在大板上开圆孔，建议使用所需直径的金刚石切割工具并一直保持表面的湿润

POSA
LAYING
POSE
VERLEGUNG
COLOCACIÓN
УКЛАДКА
铺贴

È fondamentale verificare la planarità, la differenza massima consentita è di 1 mm ogni 2 metri. EN It is essential to check warpage; the maximum tolerance permitted is 1 mm every 2 metres. Il est essentiel de vérifier la planéité, la différence de niveau maximale consentie étant de 1 mm tous les 2 mètres. Es ist von grundlegender Wichtigkeit, die Planheit sicherzustellen, die Toleranzgrenze für den Höhenunterschied beträgt 1 mm alle 2 Meter. Es fundamental comprobar la planicidad, la diferencia máxima admittida es de 1 mm cada 2 metros. Необходимо проверить планшeтность поверхности: максимальный допуск составляет 1 мм на каждые 2 метра. 平整度是至关重要的，每2米的误差最大公差不超过1毫米

Si raccomanda l'applicazione della colla con doppia spalmatura. La prima, sulla lastra da posare, deve essere parallela al lato corto. Mentre la seconda, nella stessa direzione, deve essere applicata al massetto. A double layer of glue is recommended. The first, on the slab to be laid, must be parallel to the short side, while the second must be applied to the base, and spread in the same direction. Il est recommandé d'appliquer de la colle à double encollage. Le premier, sur le carreau à poser, doit être parallèle au côté court. Le second, effectué dans le même sens, doit être appliqué sur la chape. Die Anwendung von Kleber mit doppelter Kleberschicht wird empfohlen. Die erste Klebeschicht wird auf der zu verlegenden Platte aufgetragen und muss parallel zur kurzen Seite aufgebracht werden. Die zweite Klebeschicht, in derselben Richtung, muss auf den Estrich aufgetragen werden. Se recomienda la aplicación del mortero adhesivo por doble encolado. La primera capa se aplica directamente en la placa de forma paralela al lado corto. Mientras que la segunda capa, en la misma dirección, se extiende sobre la superficie de colocación. Рекомендуется выполнять двойную намазку клея: первую - на укладываемую плитку параллельно короткой стороне, а вторую, в том же направлении, на основу. 建议双层涂抹瓷砖胶，第一次 在要铺贴大板上，必须平行于短边，第二次，在要铺贴的基面上，相同方向 涂抹

Per evitare che le lastre si scheggino durante la fase di posa si consiglia l'uso di un apposito dispositivo per l'accostamento delle lastre. To avoid the slabs being chipped during laying, an appropriate device should be used for placing the slabs next to one another. Pour éviter que les plaques ne se brisent durant la phase de pose, il est conseillé d'avoir recours à un dispositif approprié pour les aligner bord à bord. Um ein Absplittern der Platten während des Verlegens zu verhindern, wird die Verwendung einer speziellen Vorrichtung für den Anschluss der Platten empfohlen. Para evitar que las placas se astillen durante las operaciones de colocación, se recomienda utilizar un dispositivo especial para acercar las placas. Во избежание раскалывания плит во время укладки рекомендуется пользоваться специальным устройством для укладки плит. 为了避免大板破损，在铺贴期间，建议使用一个专用设备来连续铺贴

È necessario l'utilizzo di sistemi di livellatura per rendere perfetta la planarità della superficie posata. Levelling systems are recommended to ensure the surface laid is perfectly level. Utiliser un système de nivellement pour garantir une planéité parfaite de la surface posée. Die Verwendung von Nivelliersystemen wird empfohlen, um eine perfekte Planheit der verlegten Oberfläche sicherzustellen. Se recomienda utilizar sistemas de nivelación para que la superficie quede perfectamente plana. Рекомендуется использовать специальную систему выравнивающих распорок для обеспечения идеальной плоской поверхности. 需要用找平器使表面平整

Una volta adagiata la lastra, per eliminare completamente eccessi di aria, è necessario effettuare una battitura, manuale o meccanica, con l'apposito frattazzo anti-rimbazzo, procedendo dal centro verso i lati esterni. Once the slab is in position, excess air should be removed completely by tapping it either manually or mechanically using the appropriate trowel, starting from the centre and moving out towards the sides. Après la pose, pour éliminer totalement l'air emprisonné sous le carreau, le frapper, manuellement ou mécaniquement, avec une taloche anti-rebond prévue à cet effet, en procédant du centre vers les bords. Sobald die Platte abgelegt wurde muss, um überschüssige Luft austreten zu lassen, ein Anklopfen erfolgen. Dies kann entweder von Hand oder mechanisch mit einem Putzbrettchen mit Rückprallschutz erfolgen, dabei muss von der Mitte nach Außen vorgegangen werden. Una vez acomodada la placa, para eliminar por completo el exceso de aire, hay que golpear la superficie, de forma manual mecánica, con una llana antirrebote, procediendo del centro hacia los lados. После того как плитка будет уложена на основу, для удаления лишнего воздуха необходимо постучать по плитке специальной киянкой без отскока, ручной или механической, в направлении от центра к внешним краям. 当大板就位，为了消除空气，无论手工还是机械都需要使用合适工具轻敲，从中心向四周移动

Per ulteriori informazioni - For further details and information - Pour obtenir de plus amples informations Für weitere Informationen - Para obtener más información - Получить дополнительную - 了解更多信息 www.raimondispa.com



Pulizia e manutenzione

CLEANING PRODUCTS • PRODUITS DE NETTOYAGE • REINIGUNGSPRODUKTE • PRODUCTOS PARA LA LIMPIEZA • ОЧИСТКА И УХОД • 清洁和保养

Pulizia di un pavimento in ceramica

Un pavimento o una parete rivestiti con prodotto ceramico rappresentano sicuramente superfici altamente resistenti all'usura e alle macchie, la cui durata è comunque soggetta al modo in cui vengono usate e mantenute. È sufficiente a tal fine osservare alcune semplici precauzioni, dettate principalmente dal buon senso e dalla conoscenza delle caratteristiche dei materiali.

Prodotti per la pulizia.

Quello che vediamo della superficie piastrellata è costituito da prodotto ceramico e da fughe, di entrambi i quali occorre avere cura. Per la pulizia quotidiana, usare acqua e detersgenti neutri adatti, quali quelli specifici in commercio. **Evitare di utilizzare prodotti acidi o aggressivi** (ad esempio, quelli che si impiegano per la pulizia e la disincrostazione dei sanitari), che potrebbero danneggiare i materiali a base di cemento con cui vengono sigillate le fughe e opacizzare la superficie dei materiali lucidi, levigati o lappati.

Metodi di pulizia.

Per le operazioni di pulizia, limitare a casi di estrema necessità l'uso di strumenti e/o detersgenti abrasivi (quali la paglietta di metallo). Evitarne assolutamente l'uso su piastrelle con superficie lucida, più esposte alla visibilità di graffi, scalfitture e opacizzazioni.

Sporco abrasivo.

Si consiglia di prevenire il più possibile la presenza sul pavimento di polvere e sabbia trasportati dall'esterno, poiché aumentano l'effetto abrasivo del traffico pedonale. È sufficiente predisporre uno stuoino all'ingresso dell'abitazione e mantenere il pavimento più pulito possibile.

Prodotti con superficie strutturata.

Le piastrelle con superficie strutturata, i mosaici e i decori a rilievo presentano eccellenti caratteristiche di sicurezza (resistenza allo scivolamento), ma necessitano di particolare cura nella pulizia per eliminare accumuli di sporcizia nelle asperità della superficie. Nella pulizia ordinaria si può utiilizzare un normale detersgente neutro, avendo però cura di strofinare in due direzioni: prima seguendo l'orientamento della struttura, poi procedendo trasversalmente.

Pulizia di un muro in ceramica

Floors or walls tiled with ceramic products are extremely resistant to wear and stains. However, the effective durability of the surface depends on how it is used and maintained. To ensure extended durability, simply follow a few basic precautions, based on common sense and an understanding of the properties of the materials themselves.

Cleaning products. The exposed side of a tiled surface consists of the ceramic product itself and grout joints. Both components require special care. For everyday cleaning, use water and appropriate neutral detergents commonly found at supermarkets. Do not use acid or corrosive products (such as those used to remove limescale from kitchen and bathroom sanitary-ware). These may damage the cement based materials used to fill the grout joints and dull the surface of polished, honed and semi-polished materials.

Cleaning methods. When cleaning, use abrasive products (such as steel wool) and abrasive detersgents as little as possible. Never use these products on tiles with polished surfaces, as these are more susceptible to visible scratching and scoring and are more likely to become dull.

Abrasive dirt. Where possible, keep the floor free of dust and sand carried in from outside, as these increase the abrasive effect of foot traffic. Simply place a doormat at the entrance to your home and keep the floor as clean as possible.

Products with textured surfaces. Tiles with structured surfaces, mosaics and relief decorations have excellent safety qualities (slip resistance), but require greater care during cleaning to remove the dirt that accumulates in the irregularities in the surface. For regular cleaning, use a normal neutral detergent, wiping both lengthwise and crosswise to remove all dirt.

Pulizia di un pavimento in ceramica

Boden- und Wandverkleidungen mit Keramikprodukten verfügen sicher über hoch verschleiß- und fleckenbeständige Oberflächen, deren Lebensdauer dennoch davon abhängt, wie man sie behandelt und pflegt. Diesbezüglich reichen einige einfache Vorsichtsmaßregeln bzw. Vorkehrungen, die hauptsächlich auf dem gesunden Menschenverstand und den Kenntnissen bzgl. der Merkmale der Materialien beruhen.

Reinigungsprodukte. Sichtbar sind bei einer gefliesten Oberfläche das Keramikprodukt und die Fugen, welche beide gepflegt werden müssen. Für die tägliche Pflege Wasser und geeignete neutrale Reinigungsmittel verwenden, die speziell für diese Art von Pflege im Handel erhältlich sind. Keine säurehaltigen oder aggressiven Produkte gebrauchen (zum Beispiel spezifische Produkte für die Reinigung und die Enkrustung von Sanitäranlagen), welche die zementhaltigen Materialien, mit denen die Fugen versiegelt werden, beschädigen sowie die Oberflächen der glänzenden, polierten oder anpolierten Materialien mattieren bzw. trüben könnten.

Reinigungsmethoden. Für die Reinigungsarbeiten nur in extremen Fällen Utensilien und/oder abrasive Reinigungsmittel (wie zum Beispiel Metallschwämmchen) verwenden. Deren Gebrauch absolut meiden im Fall von Fliesen mit glänzender Oberfläche, auf der eventuelle Kratzer, Ritze und Mattierungen bzw. Trübungen sichtbarer sind.

Abrativer Schmutz. Wir empfehlen, so gut wie möglich dafür zu sorgen, dass kein Staub und Sand von draußen auf den Fußbodenbelag gelangt, da diese Substanzen die Abriebwirkung der Begehfrequenz erhöhen. Es reicht, wenn Sie am Wohnungseingang einen Fußabstreifer hinlegen und den Fußboden so sauber wie möglich halten.

Produkte mit strukturierter Oberfläche. Fliesen mit strukturierter Oberflächen, Reliefmosaikem und Reliefdekors weisen hervorragenden Sicherheitseigenschaften auf (Rutschsicherheit), müssen jedoch mit besonderer Sorgfalt gereinigt werden, um Schmutzanhäufungen in den Unebenheiten der Oberfläche zu beseitigen. Für die tägliche Pflege können Sie ein normales, neutrales Reinigungsmittel verwenden; allerdings sorgfältig in beide Richtungen reiben, und zwar zuerst in alle Richtungen und dann schräg, um den ganzen Schmutz zu entfernen.

Pulizia di un muro in ceramica

Un sol ou un mur en céramique sont, sans aucun doute, des surfaces extrêmement résistantes à l'usure et aux taches, dont la durée dépend aussi de l'utilisation et de l'entretien. Pour ceci, il suffit de suivre quelques règles simples, principalement dictées par le bon sens et par la connaissance des caractéristiques des produits.

Pulizia di un pavimento in ceramica

Un sol ou un mur en céramique sont, sans aucun doute, des surfaces extrêmement résistantes à l'usure et aux taches, dont la durée dépend aussi de l'utilisation et de l'entretien. Pour ceci, il suffit de suivre quelques règles simples, principalement dictées par le bon sens et par la connaissance des caractéristiques des produits.

Pulizia di un muro in ceramica

Un sol ou un mur en céramique sont, sans aucun doute, des surfaces extrêmement résistantes à l'usure et aux taches, dont la durée dépend aussi de l'utilisation et de l'entretien. Pour ceci, il suffit de suivre quelques règles simples, principalement dictées par le bon sens et par la connaissance des caractéristiques des produits.

Produits de nettoyage. La partie visible de la surface posée se constitue du produit céramique et des joints. C'est de ces deux éléments qu'il faut avoir soin. Pour le nettoyage quotidien, utilisez de l'eau et des nettoyants neutres adéquats, comme les produits spécifiques disponibles dans le commerce. Évitez d'employer des produits acides ou agressifs (par exemple, les produits pour nettoyer et détarttrer les sanitaires), qui pourraient endommager les matériaux à base de ciment utilisés pour remplir les joints et ternir les finitions brillantes, polies ou rodées.

Méthodes de nettoyage. Pour les opérations de nettoyage, n'utilisez pas des produits et/ou nettoyants abrasifs (par ex. la paille de fer) que dans les cas d'extrême nécessité. Évitez complètement de les utiliser sur les finitions brillantes qui laissent davantage apparaître les griffes, les rayures et les parties ternes.

Saleté abrasive. Nous vous conseillons de débarrasser au mieux le sol des poussières et du sable amenés de l'extérieur, car ces substances accroissent l'abrasion provoquée par le piétinement. Il suffit de placer un paillason à l'entrée de la pièce et de maintenir le sol le plus propre possible.

Produits avec surface structurée. Les finitions structurées, les mosaïques et les décors en relief présentent d'excellentes caractéristiques de sécurité (résistance au glissement), mais ils ont besoin d'être nettoyés avec beaucoup de soin afin d'enlever la saleté accumulée dans les interstices de la surface. Pour le nettoyage ordinaire, vous pouvez utiliser votre nettoyant neutre habituel. Cependant, il faudra veiller à frotter dans les deux sens: d'abord dans le sens de la saleté, puis dans le sens transversal pour tout éliminer.

Pulizia di un pavimento in ceramica

Produits de nettoyage. La partie visible de la surface posée se constitue du produit céramique et des joints. C'est de ces deux éléments qu'il faut avoir soin. Pour le nettoyage quotidien, utilisez de l'eau et des nettoyants neutres adéquats, comme les produits spécifiques disponibles dans le commerce. Évitez d'employer des produits acides ou agressifs (par exemple, les produits pour nettoyer et détarttrer les sanitaires), qui pourraient endommager les matériaux à base de ciment utilisés pour remplir les joints et ternir les finitions brillantes, polies ou rodées.

Saleté abrasive. Nous vous conseillons de débarrasser au mieux le sol des poussières et du sable amenés de l'extérieur, car ces substances accroissent l'abrasion provoquée par le piétinement. Il suffit de placer un paillason à l'entrée de la pièce et de maintenir le sol le plus propre possible.

Produits avec surface structurée. Les finitions structurées, les mosaïques et les décors en relief présentent d'excellentes caractéristiques de sécurité (résistance au glissement), mais ils ont besoin d'être nettoyés avec beaucoup de soin afin d'enlever la saleté accumulée dans les interstices de la surface. Pour le nettoyage ordinaire, vous pouvez utiliser votre nettoyant neutre habituel. Cependant, il faudra veiller à frotter dans les deux sens: d'abord dans le sens de la saleté, puis dans le sens transversal pour tout éliminer.

Pulizia di un muro in ceramica

Los pavimentos o paredes revestidos con productos cerámicos constituyen seguramente superficies altamente resistentes al desgaste y a las manchas, cuya duración dependerá, en cualquier caso, del modo en que se usen y mantengan. Para ello, bastará con cumplir algunas simples precauciones, dictadas principalmente por el sentido común y por el conocimiento de las características de los materiales.

Productos para la limpieza. Lo que vemos de una superficie revestida con azulejos o baldosas está constituido por un producto cerámico y por juntas, debiendo cuidarse ambos elementos. Para la limpieza diaria, usar agua y detersgentes neutros adecuados, como los productos específicos que existen en el mercado. No utilizar productos ácidos o agresivos (por ejemplo, los que se emplean para la limpieza y la desincrustación de los sanitarios), puesto que podrían dañar los materiales a base de cemento con los que se sellan las juntas y volver opaca la superficie de los materiales lustrados, pulidos o lapeados.

Métodos de limpieza. Para las operaciones de limpieza, limitar a casos de extrema necesidad el uso de instrumentos y/o detersgentes abrasivos (como los estropajos metálicos). Evitar absolutamente su uso sobre azulejos y baldosas con superficie lustrada, más expuestas a la visibilidad de los arañazos, rasguños y opacificaciones.

Suciedad abrasiva. Se aconseja prevenir lo más posible la presencia en el pavimento de polvo y arena transportados del exterior, ya que aumentan el efecto abrasivo del tránsito peatonal. Para ello, bastará con colocar un felpudo a la entrada de la vivienda y mantener el pavimento lo más limpio posible.

Productos con superficie estructurada. Las baldosas con superficie estructurada, los mosaicos y las decoraciones de relieve presentan excelentes características de seguridad (resistencia al deslizamiento), pero necesitan un cuidado especial en la limpieza a fin de eliminar acumulaciones de suciedad en las irregularidades de la superficie. Para la limpieza ordinaria podrá utilizarse un detersgente neutro normal, teniendo cuidado de restregar en dos direcciones, siguiendo primero su orientación y luego en sentido transversal para eliminar toda la suciedad.

Pulizia di un pavimento in ceramica

Пол или стена, облицованные керамическим продуктом, несомненно, представляют собой поверхности, очень прочные на износ и устойчивые к пятнам, чья долговечность зависит, в любом случае, от способа применения и эксплуатации. Для этого достаточно соблюдать некоторые простые меры предосторожности, продиктованные, в основном, здравым смыслом и знанием характеристик материалов.

Продукты для очистки. Глядя на поверхность, покрытую плиткой, мы видим керамический продукт и швы: и то, и другое нуждается в уходе. Для ежедневной очистки следует использовать воду и подходящие нейтральные чистящие средства, например, специальные продукты, имеющиеся в продаже. Избегать использования кислотных или агрессивных продуктов (например, тех, что используются для мытья и удаления накипи с сантехники), которые могут повредить материалы на цементной основе, применяющиеся для герметизации швов, и матировать поверхность из глянцевых, полированных или полуполированных материалов.

Способы очистки. Для операций по очистке свести к минимуму случаи с чрезвычайной необходимостью использования абразивных инструментов и/или моющих средств (как, например, металлическая стружка). Категорически советуем избегать их применение на плитках с глянцевой поверхностью, где царапины, порезы и матирование более заметны.

Абразивная грязь. Советуем предотвращать, по мере возможности, присутствие на полу пыли и песка, принесенных снаружи, т.к. они увеличивают абразивный эффект пешеходного движения. Достаточно постелить циновку у входа в дом и сохранять пол как можно более чистым.

Продукты со структурированной поверхностью. Плитка со структурированной поверхностью, мозаика и рельефный декор представляют превосходные характеристики в плане надежности (сопротивление скольжению), но требуют особого ухода при очистке для удаления скоплений грязи в шероховатостях поверхности. При обычной очистке можно использовать обыкновенное нейтральное моющее средство, не забывая, однако, тереть в двух направлениях: сначала следуя направлению структуры, затем в поперечном направлении.

Pulizia di un muro in ceramica













NORME DI MANUTENZIONE MAINTENANCE INSTRUCTIONS • INSTRUCTIONS D'ENTRETIEN • PFLEGEANLEITUNGEN • NORMAS DE MANTENIMIENTO • НОРМЫ ПО УХОДУ • 保养规定

TIPO DI SPORCO <p>TYPE OF STAIN • TYPE DE TACHE • ART DER VERSCHMUTZUNG <p>TIPO DE MANCHA • ТИП ЗАГРЯЗНЕНИЯ • 脏物类型</p></p>	INDICAZIONI PER LA PULIZIA <p>CLEANING SUGGESTIONS • CONSEIL POUR LE NETTOYAGE • REINIGUNGSHINWEISE <p>INDICACIONES PARA LA LIMPIEZA • УКАЗАНИЯ ПО ОЧИСТКЕ • 清洁说明</p></p>
Grassi animali o vegetali • Caffè • Coca Cola • Gelato • Salsa Ketchup <p>Vegetable and animal fat • Coffee • Coke • Ice cream • Ketchup <p>Graisses végétales et animales • Café • Coca Cola • Glace • Ketchup <p>Tierische oder pflanzliche Fette • Kaffee • Coca Cola • Eis • Ketchup <p>Grasas vegetales y animales • Café • Coca Cola • Helado • Ketchup <p>Животные или растительные жиры • Кофе • Кока Кола • Мороженое • Соус Кетчуп <p>动物或植物脂肪 • 咖啡 • 可口可乐 • 雪糕 • 调味蕃茄酱</p></p></p></p></p></p>	Detergenti a base alcalina <p>Alkaline-based detergent <p>Détergents à base alcaline <p>Alkalische Reinigungsmittel <p>Detergentes con base alcalina <p>Чистящие средства на щелочной основе <p>碱性清洁剂</p></p></p></p></p></p>
Depositi • Effluorescenze calcaree • Inchiostri • Ruggine e depositi ferrosi <p>Deposits • Calcareous efflorescences matter • Ink • Rust and Oxidations <p>Dépôts • Efflorescences de calcaire • Encres • Rouille • Oxydation <p>Ablagerungen • Kalkablagerungen • Tinte • Rost • Oxydation <p>Depósitos • Eflorescencias calcáreas • Tintas • Herrín • Oxidaciones <p>Осадок • Известняковый налет • Чернила • Ржавчина и железный налет <p>沉淀物 • 水垢 • 墨汁 • 锈迹和铁沉淀</p></p></p></p></p></p>	Detergente a base acida* <p>Acid-based detergents* <p>Nettoyants à base d'acide* <p>Reinigungsmittel mit Säure * <p>Detergentes con base ácida* <p>Чистящие средства на кислотной основе* <p>酸性清洁剂*</p></p></p></p></p></p>
Olii di parti meccaniche • Gomma da pneumatico • Resine o smalti • Cera di candela • Grafite (matita) <p>Grease from machines • Tyre rubber • Paints • Candle wax • Graphite (pencil) <p>Huile de graissage • Caoutchouc pour pneus • Peinture • Cire de bougie • Graphite (crayon) <p>Machinenöl • Gummi • Harz oder Lack • Kerzenwachs • Graphit (Bleistift) <p>Aceites de componentes mecánicos • Goma (neumáticos) • Esmaltes y resinas • Cera de vela • Grafito (lápiz) <p>Масло механических частей • Пневматическая шина • Смола или лак • Воск от свечи • Графит (карандаш) <p>机械部件的机油 • 轮胎 • 树脂或油漆 • 蜡烛的蜡 • 石墨（铅笔）</p></p></p></p></p></p>	Solvente <p>Solvent <p>Solvant <p>Lösungmittel <p>Disolvente <p>Растворитель <p>溶剂</p></p></p></p></p></p>
Birra • Vino • Piombatura da levigatura <p>Beer • Wine • Lead finishing of the polish process <p>Bière • Vin • Piomb de polissage <p>Bier • Wein • Bleireste vom Polieren <p>Cerveza • Vino • Empaste de pulido <p>Пиво • Вино • Свинцовое покрытие от полирования <p>啤酒 • 葡萄酒 • 研磨铅封</p></p></p></p></p></p>	Detergenti a base alcalina • Detergente a base acida* <p>Alkaline-based detergent • Acid-based detergents* <p>Détergents à base alcaline • Nettoyants à base d'acide* <p>Alkalische Reinigungsmittel • Reinigungsmittel mit Säure * <p>Detergentes con base alcalina • Detergentes con base ácida* <p>Чистящие средства на щелочной основе • Чистящие средства на кислотной основе* <p>碱性清洁剂 • 酸性清洁剂*</p></p></p></p></p></p>
Lampostil <p>Felt tipped pen <p>Feutres <p>Flizstif <p>Rotulador <p>Фломастеры <p>彩笔色彩</p></p></p></p></p></p>	Solvente • Detergente a base acida* <p>Solvent • Acid-based detergent* <p>Solvant • Nettoyants à base d'acide* <p>Lösungmittel • Reinigungsmittel mit Säure * <p>Disolvente • Detergentes con base ácida* <p>Растворитель • Чистящие средства на кислотной основе* <p>溶剂 • 酸性清洁剂*</p></p></p></p></p></p>
Olio di lino <p>Linseed oil <p>Huile de lin <p>Leinöl <p>Aceite de lino <p>Льняное масло <p>亚麻油</p></p></p></p></p></p>	Detergenti a base alcalina • Solvente <p>Alkaline-based detergent • Solvent <p>Détergents à base alcaline • Solvant <p>Alkalische Reinigungsmittel • Lösungmittel <p>Detergentes con base alcalina • Disolvente <p>Чистящие средства на щелочной основе • Растворитель <p>碱性清洁剂 • 溶剂</p></p></p></p></p></p>
Pulizia quotidiana <p>Daily cleaning <p>Maintenance journalière <p>Routine-Reinigung <p>Mantenimiento cotidiano <p>Ежедневная очистка <p>日常清洁</p></p></p></p></p></p>	Acqua e detersgenti neutri <p>Water and neutral detergents <p>Eau et nettoyants neutres <p>Wasser und neutrale Reinigungsmittel <p>Agua y detergentes neutros <p>Вода и нейтральные моющие средства <p>水和中性清洁剂</p></p></p></p></p></p>









* Vedi le indicazioni da pag. 330 a pag. 336 • See instructions from page 330 to page 336 • Voir les instructions de la page 330 à la page 336 • Siehe Anleitungen von S. 330 bis S. 336 • Véanse las indicaciones desde pág. 330 hasta pág. 336 • См. указания со стр. 330 до стр. 336 • 参阅从第 330 页到第 336 页的说明

Caratteristiche generali

GENERAL CHARACTERISTICS • CARACTERISTIQUES GENERALES • ALLGEMEINE EIGENSCHAFTEN • CARACTERISTICAS GENERALES • ОБЩИЕ ХАРАКТЕРИСТИКИ • 综合特点

GRES FINE PORCELLANATO		FINE PORCELAIN STONWARE / GRÈS CÉRAME FIN / FEINSTEINZEUG GRES FINO PORCELÁNICO / ТОККИЙ КЕРАМОГРАНИТ / 精细炻瓷		EN 14411/G Bla	
	Assorbimento d'acqua Water absorption Absorption d'eau Wasseraufnahme Absorción de agua Водопоглощение 吸水率	ISO 10545-3	≤ 0,5%	Conforme Comply with Conforme Gemäß Conforme Соответствует 符合	VALORE GARDENIA GARDENIA VALUES VALEUR GARDENIA GARDENIA WERTE VALOR GARDENIA КЛАССИФИКАЦИЯ GARDENIA 数值
	Resistenza alla flessione Bending strength Résistance à la flexion Biegezugfestigkeit Resistencia a la flexión Прочность на изгиб 抗挠强度 Sforzo di rottura Breakage resistance Resistance a la rupture Bruchlast Resistencia a la rotura Усилие на излом	ISO 10545-4	Sforzo di rottura > 35 N/mm² Modulo di rottura > 1300 N Breaking stress > 35 N/mm ² Form breaking > 1300 N Charge de rupture > 35 N/mm ² Résistance à la flexion > 1300 N Biegefestigkeit > 35 N/mm ² Biegefestigkeit > 1300 N Resistencia a la ruptura > 35 N/mm ² Modulo de ruptura > 1300 N Разрушающее усилие > 35 N/mm ² Модуль разрыва > 1300 N 断裂力量 > 35 N/mm ² 断裂模数 > 1300 N	Conforme Comply with Conforme Gemäß Conforme Соответствует 符合	
	Resistenza all'abrasione superficiale Abrasion resistance Resistance a l'abrasion superficielle Oberflächenabriebfestigkeit Resistencia a la abrasión superficial Поверхностная устойчивость к абразивному износу 表面耐磨	ISO 10545-7	ISO 3 min Minimum ISO 3 Minimum ISO 3 Mindestens ISO 3 Minimo ISO 3 Класс 3 мин 最小3级	Conforme Comply with Conforme Gemäß Conforme Соответствует 符合	
	Durezza (Scala Mohs) Hardness (Mohs scale) Dureté (échelle Mohs) Oberflächenhärte (nach Mohs) Durezza (crad) Твердость (шкала Мооса) 硬度 (莫氏)	(EN 101)	≥ 6*	Conforme Comply with Conforme Gemäß Conforme Соответствует 符合	
	Coefficiente di dilatazione termica lineare Coefficient of linear thermal expansion Coefficient de dilatation thermique linéaire Wärmeausdehnung Coeficiente de dilatación termica linear Кoeffициент теплового линейного расширения 线性热膨胀系数	ISO 10545-8	≤ 9x10 ⁻⁶ °C ⁻¹	Conforme Comply with Conforme Gemäß Conforme Соответствует 符合	
	Resistenza agli sbalzi termici Thermal shock resistance Résistance aux écarts de température Temperaturwechselbeständigkeit Resistencia a las variaciones termicas Стойкость к тепловым ударам 耐热突变	ISO 10545-9	Nessun campione deve presentare difetti visibili No sample must show visible defects Aucun échantillon ne doit présenter des défauts visibles Kein Exemplar soll sichtbare Schäden aufweisen Ninguna muestra debe presentar defectos visibles Ни на одном образце не должно быть видимых дефектов 任何样品都不得存在肉眼缺陷	Conforme Comply with Conforme Gemäß Conforme Соответствует 符合	
	Resistenza al gelo Frost resistance Résistance au gel Frostbeständigkeit Resistencia al hielo Морозостойкость 防冻	ISO 10545-12	Nessun campione deve presentare rotture o alterazioni a apprezzabili della superficie No sample must show breaks or evident alterations of the surface Les échantillons ne doivent pas présenter de ruptures ou d'altérations considérables de la surface Die Muster dürfen weder Bruch noch Schäden an der Oberfläche aufweisen Ninguna muestra debe presentar roturas o alteraciones apreciables de la superficie На поверхности образцов не должно быть сколов и заметных нарушений 任何样品都不得存在破裂或表面有可鉴别的变质	Conforme Comply with Conforme Gemäß Conforme Соответствует 符合	
	Resistenza all'attacco chimico ² Chemical resistance ² Résistance à l'attaque chimique ² Beständigkeit gegen Chemikalien ² Resistencia química ² Химическая устойчивость ² 耐化学作用 ²	ISO 10545-13	Metodica di prova disponibile Testing method available Norme d'essais Prüfverfahren greifbar Metodologia de pruebas disponibles Имеющаяся методика проверки 备有测试方法论	Conforme Comply with Conforme Gemäß Conforme Соответствует 符合	
	Resistenza alle macchie Stain resistance Résistance aux taches Fleckenbeständigkeit Resistencia a las manchas Стойкость к образованию пятен 防污	ISO 10545-14	Classe 3 min Minimum class 3 Minimum classe 3 Mindestens Klasse 3 Minimo categoria 3 Класс 3 мин 最小3级	Conforme Comply with Conforme Gemäß Conforme Соответствует 符合	
	Resistenza dei colori alla luce Color resistance to light Résistance des couleurs à la lumière Lichtbeständigkeit Resistencia de los colores a la luz Светостойкость цветов 颜色耐光	DIN 51094	Non devono presentare apprezzabili variazioni di colore No noticeable color change Ne doivent pas présenter de variations importantes des couleurs Die Muster dürfen keine sichtbaren Farbveränderungen aufweisen Muestras inalteradas en brillo y color Образцы неизменны по яркости и цвету 不得存在可鉴别的颜色变化	Conforme Comply with Conforme Gemäß Conforme Соответствует 符合	
	Resistenza allo scivolamento ambienti bagnati o umidi Slip resistance in wet location Rutschhemmung ³ Bodenbeläge in nassbelasteten Barfußbereichen ³ Resistencia al deslizamiento en lugares húmedos ³ Спротивление скольжению при условиях влажной поверхности 潮湿的环境下防滑	DIN 51097	Da 12° a 18° - A Da 18° a 24° - B > 24° - C	Conforme Comply with Conforme Gemäß Conforme Соответствует 符合	
	Resistenza allo scivolamento ³ Slip resistance ³ Résistance au glissement ³ Bestimmung der Rutschhemmenden Eigenschaft ³ Resistencia al deslizamiento ³ Спротивление скольжению ³ 防滑 ³	DIN 51130	6° < α ≤ 10° = R9 10° < α ≤ 19° = R10 19° < α ≤ 27° = R11 27° < α ≤ 35° = R12 α > 35° = R13	Valore fornito a richiesta Value supplied on demand Donné fourni à la demande Wert auf Wunsch erteilt Valor dado a petición Значение дается по запросу 根据要求提供数值	

* Mohs ≥ 5 Superficie Lappata . Semi-polished surface . surface Semi-Poli . Anpoliert Oberfläche . Superficie Semi-pulido . Полуполированный . 抛光

BICOTTURA		DOUBLE FIRING / BICUISSON / ZWEIBRANDVERFAHREN BICOCCION / ДВУКРАТНЫЙ ОБЖИГ / 二次烧成		EN 14411/K BIII GL	
	Assorbimento d'acqua Water absorption Absorption d'eau Wasseraufnahme Absorción de agua Водопоглощение 吸水率	ISO 10545-3	> 10%	Conforme Comply with Conforme Gemäß Conforme Соответствует 符合	VALORE GARDENIA GARDENIA VALUES VALEUR GARDENIA GARDENIA WERTE A VALOR GARDENIA КЛАССИФИКАЦИЯ GARDENIA 数值
	Resistenza alla flessione Bending strength Résistance à la flexion Biegezugfestigkeit Resistencia a la flexión Прочность на изгиб 抗挠强度	ISO 10545-4	Media 15 N/mm² con spessore > 7,5 mm In average 15 N/mm ² with thickness > 7,5 mm En moyenne 15 N/mm ² avec épaisseur > 7,5 mm Durchschnittlich 15 N/mm ² mit Staerke > 7,5 mm Media de 15 N/mm ² con espesor > 7,5 mm В среднем 15 N/mm ² при толщине > 7,5 mm 平均15N/mm ² , 厚度>7.5 mm	Conforme Comply with Conforme Gemäß Conforme Соответствует 符合	
	Durezza (Scala Mohs) Hardness (Mohs scale) Dureté (échelle Mohs) Oberflächenhärte (nach Mohs) Durezza (crad) Твердость (шкала Мооса) 硬度 (莫氏)	(EN 101)	≥ 3	Conforme Comply with Conforme Gemäß Conforme Соответствует 符合	
	Coefficiente di dilatazione termica lineare Coefficient of linear thermal expansion Coefficient de dilatation thermique linéaire Wärmeausdehnung Coeficiente de dilatación termica linear Кoeffициент теплового линейного расширения 线性热膨胀系数	ISO 10545-8	≤ 9x10 ⁻⁶ °C ⁻¹	Conforme Comply with Conforme Gemäß Conforme Соответствует 符合	
	Resistenza all'attacco chimico Chemical resistance Résistance à l'attaque chimique Beständigkeit gegen Chemikalien Resistencia química Химическая устойчивость 耐化学作用	ISO 10545-13 (EN 106)	Metodica di prova disponibile Testing method available Prüfverfahren greifbar Norme d'essais Metodologia de pruebas disponibles Имеющаяся методика проверки 备有测试方法论	Conforme Comply with Conforme Gemäß Conforme Соответствует 符合	
	Resistenza alle macchie Stain resistance Résistance aux taches Fleckenbeständigkeit Resistencia a las manchas Стойкость к образованию пятен 防污	ISO 10545-14	Classe 3 min Minimum class 3 Minimum classe 3 Mindestens Klasse 3 Minimo categoria 3 Класс 3 мин 最小3级	Conforme Comply with Conforme Gemäß Conforme Соответствует 符合	
	Resistenza dei colori alla luce Color resistance to light Résistance des couleurs à la lumière Lichtbeständigkeit Resistencia de los colores a la luz Светостойкость цветов 颜色耐光	DIN 51094	Non devono presentare apprezzabili variazioni di colore No noticeable color change Ne doivent pas présenter de variations importantes des couleurs Die Muster dürfen keine sichtbaren Farbveränderungen aufweisen No deben presentar variaciones apreciables de color Изменения цвета должны быть незначительны 不得存在可鉴别的颜色变化	Conforme Comply with Conforme Gemäß Conforme Соответствует 符合	
	Resistenza al Cavillo ⁴ Crazing resistance ⁴ Résistance aux craquelures ⁴ Haarriß-Beständigkeit ⁴ Resistencia al cuarteo ⁴ Стойкость к образованию кракелюров ⁴ 耐瑕疵 ⁴	ISO 10545-11	Richiesta Demande Demande Nachfrage Demanda Требование 要求	Conforme Comply with Conforme Gemäß Conforme Соответствует 符合	

¹ Metodo applicabile alle sole piastrelle di ceramica non smaltate. Il metodo di prova e l'espressione dei risultati sono uguali a quelli riportati nelle precedenti Norme Europee (EN 102). È stata apportata solo una modifica per quanto riguarda il materiale da usare per la calibrazione dello strumento. La procedura di taratura rimane invariata.

² Method only applicable to unglazed ceramic tiles. The testing method and the expression of results are the same as those indicated in the previous European Standards (EN 102). Only one modification has been made regarding the material to be used for the calibration of the instrument. The calibration procedure remains unchanged.

³ Méthode applicable uniquement aux carreaux de céramique non émaillés. La méthode d'essai et l'expression des résultats sont les mêmes que celles reportées aux Normes européennes précédentes (EN 102). Il n'a été apporté qu'une modification en ce qui concerne le matériel à utiliser pour le calibrage de l'instrument. La procédure d'étalonnage reste inchangée.

⁴ Nur für unglasierte Keramikfliesen anwendbare Methode. Die Prüfmethode und die Auswertung der Ergebnisse entsprechen denen, die in den vorhergehenden europäischen Richtlinien (EN 102) aufgeführt sind. Es wurde nur in Bezug auf das für die Gerätekalibrierung verwendete Material eine Änderung vorgenommen. Die Eichmethode bleibt gleich.

⁵ Método aplicable sólo a los azulejos de cerámica no esmaltados. El método de prueba y la expresión de los resultados son iguales a aquellos indicados en las anteriores Normas Europeas (EN 102). Se aportó solamente una modificación a todo lo referido al material a utilizar para la calibración del instrumento. El procedimiento de calibración permanece invariable.

⁶ Метод применим только не эмальированным керамическим плиткам. Метод испытаний и выражение результатов соответствуют тем, которые указаны в предшествующих Европейских Нормах (EN 102). Единственная модификация касается использования материала для калибровки прибора. Процедура калибровки остается без изменений. Этот метод применим только для неэмальированных керамических плиток. Метод испытаний и выражение результатов соответствуют тем, которые указаны в предшествующих Европейских Нормах (EN 102). Единственная модификация касается использования материала для калибровки прибора. Процедура калибровки остается без изменений.

⁷ 此方法仅适用于无釉瓷砖。测试方法及结果的表达与之前欧洲标准 (EN 102) 中的结果是相同的。只有当涉及到用来校准的材料时，产生了一个改变。校准过程保持不变。

¹ Escluso i prodotti lappati ed i levigati.

² Semi-polished and polished products are excluded.

³ À exclusion des produits semi-polis et polis.

⁴ Ausgenommen polierte und anpolierte Produkte.

⁵ Los productos lapados y pulidos están excluidos.

⁶ За исключением полуполированных и полированных продуктов.

⁷ 不包括研磨和抛光产品。

¹ Escluso i prodotti lappati, i levigati e tutti quelli non contrassegnati.

² Semi-polished, polished and all products not marked are excluded.

³ À exclusion des produits semi-polis, polis et tous ceux qui n'ont pas été contrassegnés.

⁴ Ausgenommen polierte, anpolierte und alle nicht kenngezeichnete Produkte.

⁵ Los productos lapados, pulidos y todos los que no han sido mencionados están excluidos.

⁶ За исключением полуполированных, полированных и всех других неотмеченных продуктов.

⁷ 不包括抛光、研磨和所有那些没有标明的产品。

⁴ Certi effetti decorativi su decori e pezzi speciali possono provocare una tendenza al cavillo, quindi si intendono non soggetti alla prescrizione.

⁵ Certain decorative effects on accents and trim pieces can produce a tendency to craze, so they are not covered by the standard.

⁶ Certains effets décoratifs sur décors et pièces spéciales sont susceptibles de faire apparaître des craquelures, ils ne sont donc pas soumis à cette norme.

⁷ Gewisse Dekorationseffekte auf Dekor- und Formteile können zur Haarrißbildung neigen und müssen daher als normabweichende Ausnahme betrachtet werden.

⁸ Ciertos efectos decorativos sobre decoraciones y piezas especiales pueden provocar una tendencia al cuarteado, por lo tanto no están sujetos a la prescripción.

⁹ Некоторые декоративные эффекты на декоре и специальных изделиях могут вызвать тенденцию к кракелюрам, следовательно, они не подлежат рекомендации.

¹⁰ 装饰件及特殊件上的某些装饰效果可能会引起争辩，因此不纳在规范范围内。

Garanzia e reclami

WARRANTY AND COMPLAINTS • GARANTIE ET RECLAMATIONS • GARANTIE UND REKLAMATIONEN • GARANTÍA Y RECLAMACIONES • ГАРАНТИЯ И РЕКЛАМАЦИИ • 质保与申诉

Garanzia e Reclamo

I materiali di GARDENIA ORCHIDEA sono garantiti in conformità alle normative internazionali attualmente in vigore.

La nostra garanzia è limitata alla sola merce fornita in **prima scelta** che risulta oggetto della norma UNI EN 14411 a cui facciamo riferimento. Reclami relativi a merce di scelta differente (commerciale, secondaria, seconda, terza, stock etc.) non saranno presi in considerazione.

L'Acquirente ha l'obbligo di verificare la merce in termini di qualità e quantità entro breve tempo dal ricevimento della merce e, in caso di reclamo, darne comunicazione scritta, a

mezzo di lettera raccomandata con avviso di ricevimento, entro e non oltre **8 (otto) giorni** dal ricevimento della stessa, pena la decadenza da ogni diritto.

L'Acquirente che abbia avanzato reclamo in tempo utile dovrà tener ferma, a disposizione di GARDENIA ORCHIDEA per le verifiche che riterrà opportuno effettuare, tutta la partita di materiale e, ove siano accertati vizi o difetti di qualità egli avrà diritto alla sola sostituzione dei materiali difettosi; ogni ulteriore azione (reso, riparazione o altro) dovrà essere da noi preventivamente autorizzata per iscritto.

Reclami e richieste di intervento in garanzia dopo la posa in opera non verranno prese in considerazione nel caso in cui il difetto dovesse risultare palese (sbeccate, difetti di superficie, difetti dimensionali, differenze di tono etc.). Ogni installazione, anche parziale del materiale, costituisce accettazione incondizionata dei beni.

Si precisa che la prima scelta può contenere piastrelle difettose (ISO 10545/2) nel limite del 5% (cinque per cento) e che la tonalità del materiale fornito può differire dal campione esposto, essendo la ceramica intrinsecamente variabile come aspetto.

I reclami imputati a difetti occulti dovranno essere segnalati a noi per iscritto entro **8 (otto) giorni** dalla scoperta e, in ogni caso, entro un anno dalla consegna, pena la decadenza da ogni diritto.

Qualora il reclamo dovesse risultare infondato l'Acquirente dovrà risarcire GARDENIA ORCHIDEA di tutte le spese sostenute per l'accertamento (viaggi, alloggi, perizie etc.)

In ogni caso, la nostra garanzia comprende unicamente la sostituzione del materiale riscontrato difettoso, o alla riparazione, con espressa esclusione di ogni ulteriore e diversa obbligazione quali, a titolo indicativo e non limitativo, costi di rimozione e sistemazione del mobilio, attrezzature, macchinari, disagi, danni indiretti etc.

La presenza di piastrelle difettose non inficia la qualità dell'intera fornitura, né comporta l'obbligo della integrale sostituzione.

Eventuali contestazioni sul materiale non danno diritto all'Acquirente di sospendere, o ritardare in tutto o in parte, il pagamento nei termini pattuiti.

I limiti temporali della durata della garanzia sono quelli stabiliti dal codice civile italiano.

FORO COMPETENTE

Per qualsiasi controversia, comunque derivante dal contratto di fornitura, tanto da parte di Gardenia Orchidea come da parte dell'Acquirente, è esclusivamente competente il tribunale di Modena.

È comunque facoltà di GARDENIA ORCHIDEA adire autorità giudiziarie diverse.

FORO COMPETENTE

Per qualsiasi controversia, comunque derivante dal contratto di fornitura, tanto da parte di Gardenia Orchidea come da parte dell'Acquirente, è esclusivamente competente il tribunale di Modena.

È comunque facoltà di GARDENIA ORCHIDEA adire autorità giudiziarie diverse.

FORO COMPETENTE

Per qualsiasi controversia, comunque derivante dal contratto di fornitura, tanto da parte di Gardenia Orchidea come da parte dell'Acquirente, è esclusivamente competente il tribunale di Modena.

FORO COMPETENTE

The materials of GARDENIA ORCHIDEA are guaranteed in accordance with the international standards currently in force.

Our guarantee is limited to **first choice** products pursuant to reference standard UNI EN 14411. Complaints related to goods of different choice (commercial, secondary, second, third, stock, etc.) will not be considered.

The Purchaser is required to verify the quality and quantity of the goods shortly after having received them. In order for the purchaser not to lose his warranty rights, if a complaint is to be lodged, it must be made in writing, by registered letter with acknowledgment of receipt, within **8 (eight) days** of having received the goods.

A Purchaser who has made a complaint within the appropriate time limit must make all the materials received available to GARDENIA ORCHIDEA in order that any verifications that it deems appropriate can be carried out. If faults or quality defects are ascertained, the purchaser will be required to the replacement of the defective materials only. Any other option (return, repair or other), must be authorized in advance and in writing by us.

Claims and requests for assistance under warranty after installation will not be taken into consideration in the event that the defect is obvious (chips, surface defects, dimensional defects, differences in tone etc.). The installation, even partial, of the materials constitutes the unconditional acceptance of the goods.

Please note that the ‘first choice’ materials may contain up to 5% (five percent) defective tiles (ISO 10545/2) and that the shade of the materials supplied may differ from the sample displayed, because ceramics are inherently variable in appearance.

Claims in relation to hidden defects must be reported to us in writing within **8 (eight) days** of their discovery and, in any case, within a year of delivery. Failure to do so will result in the loss of the purchaser’s warranty rights.

In the event that a claim should prove to be unfounded, the Purchaser shall compensatе GARDENIA ORCHIDEA for all expenses incurred in relation to investigating the claim (travel, accommodation, appraisals etc.)

In any event, our guarantee is limited to the replacement or repair of the materials found to be defective, and explicitly excludes any further or different obligation, such as, but in no way limited to, costs of removal and rearrangement of furniture, equipment, machinery, inconvenience, indirect damages etc.

The presence of defective tiles in no way invalidates the quality of the entire supply, nor does it imply the obligation of full replacement.

Any claims made in respect to the materials do not give the purchaser the right to suspend or delay, in whole or in part, the payment within the agreed terms.

The time limit regarding the warranty period are those established by the Italian Civil Code.

JURISDICTION

The court of Modena has exclusive jurisdiction for any disputes, however arising, in relation to the supply contract, either on the part of Gardenia Orchidea or on that of the purchaser. GARDENIA ORCHIDEA is however entitled to bring proceedings before other courts.

FORO COMPETENTE

FORO COMPETENTE

FORO COMPETENTE

FORO COMPETENTE

Les matériaux de GARDENIA ORCHIDEA sont garantis conformes avec les normes internationales actuellement en vigueur.

Notre garantie se limite à la seule marchandise fournie de **premier choix** qui fait l'objet de la norme UNI EN 14411 à laquelle nous nous référons. Les réclamations se référant à une marchandise de choix différent (commerciale, secondaire, deuxième/troisième choix, en stock, etc.) ne seront pas prises en considération.

L'Acheteur est tenu de vérifier la marchandise en termes de qualité et quantité à court terme à partir de la réception de la marchandise et, en cas de réclamation, d'en donner communication écrite par lettre recommandée avec accusé de réception, au plus tard **8 (huit) jours** de la réception de celle-ci, sous peine de la déchéance de tout droit.

On tient à préciser que le premier choix peut présenter des carreaux défectueux (ISO 10545/2) dans la limite de 5% (cinq pour cent) et que la nuance du matériau fourni peut différer de l'échantillon exposé, la céramique étant intrinsèquement variable dans son aspect.

Les réclamations attribuées à des défauts occultes nous devront être signalées par écrit d'ici **8 (huit) jours** de leur apparition et, en tout cas, d'ici un an de la livraison, sous peine de la déchéance de tout droit.

Au cas où la réclamation devrait résulter infondée, l'Acheteur devra dédommager GARDENIA ORCHIDEA de tous les frais soutenus pour la vérification (voyages, hébergements, expertises, etc.)

En tout cas, notre garantie ne comprend que le remplacement du matériel relevé défectueux ou la réparation, avec exclusion expresse de toute autre et différente obligation telle que, à titre indicatif et non limitatif, coûts d'enlèvement et réaménagement du mobilier, équipements, outillages, gênes au travail, dommages indirects, etc.

La présence de carreaux défectueux n'infirmе pas la qualité de toute la fourniture, ni comporte l'obligation du remplacement intégral.

Les contestations éventuelles sur le matériel ne donnent aucun droit à l'Acheteur de suspendre ou de retarder, totalement ou partiellement, le paiement dans les délais établis.

Les limites temporelles de la durée de la garantie sont celles attribuées par le code civil italien.

TRIBUNAL COMPETENT

Pour toute controverse, dérivant de toute façon du contrat de fourniture, aussi bien de la part de Gardenia Orchidea que de la part de l'Acheteur, les parties reconnaissent exclusivement la compétence du Tribunal de Modène.

GARDENIA ORCHIDEA a de toute façon la faculté de faire appel à des juridictions différentes.

FORO COMPETENTE

FORO COMPETENTE

FORO COMPETENTE

FORO COMPETENTE

FORO COMPETENTE

FORO COMPETENTE

FORO COMPETENTE

Das GARDENIA ORCHIDEA-Material wird in Übereinstimmung mit den zur Zeit geltenden internationalen Richtlinien garantiert

Unsere Garantie beschränkt sich auf die **als erste Wahl** gelieferte Ware. , die der Norm UNI EN 14411 unterliegen, auf die wir uns beziehen. Reklamationen in Bezug auf Ware einer anderen Qualitätsstufe (kommerziell, sekundär, zweite Wahl Stockware, usw.) werden nicht berücksichtigt. Der Käufer hat die Pflicht die Qualität und Menge der Ware, innerhalb von kurzer Zeit nach ihrem Empfang zu prüfen und eine eventuelle Reklamation schriftlich, durch ein Einschreiben mit Rückschein, innerhalb von höchstens **8 (acht) Tagen** nach Wareneingang zu melden, bei sonstigem Verfall aller Rechte.

Der Käufer, der die Reklamation fristgerecht gemeldet hat, muss die gesamte Materialpartie der Fa. GARDENIA ORCHIDEA zur Verfügung halten, für eventuelle Überprüfungen, die diese für angebracht erachtet. Wenn Qualitätsmängel oder -defekte festgestellt werden, hat der Käufer nur Anrecht auf den Austausch des defekten Materials. Jede weitere Aktion (Rücksendung, Reparatur oder anderes) muss von uns im voraus schriftlich genehmigt werden.

Reklamationen und Garantieeingriffe nach der Verlegung werden nicht berücksichtigt, wenn der Defekt offensichtlich ist (abgeschlagene Stellen, Oberflächendefekte, Maßdefekte, Farbtonunterschiede, usw.). Jede Verlegung, auch Teilverlegung des Materials stellt die vorbehaltlo-se Annahme der Waren dar.

Es wird darauf hingewiesen, dass die erste Wahl bis zu einer Grenze von 5% (fünf Prozent) defekte Fliesen (ISO 10545/2) enthalten und, dass der Farbton des gelieferten Materials vom ausge-stellten Muster abweichen kann, da das Aussehen von Keramik an und für sich unterschiedlich ist. Reklamationen für versteckte Mängel müssen uns innerhalb von **8 (acht) Tagen** nach ihrer Entdeckung gemeldet werden und auf jeden Fall innerhalb von einem Jahr nach der Lieferung, bei sonstigem Verfall aller Rechte.

Wenn die Reklamation als gegenstandslos angesehen wird, muss der Käufer der Fa. GARDENIA ORCHIDEA alle für die Feststellung getragenen Kosten (Reise, Übernachtung, Gutachten, usw.) erstatten.

Auf jeden Fall enthält die Garantie ausschließlich den Austausch des als defekt angesehenen Materials oder die Reparatur, mit ausdrücklichem Ausschluss weiterer oder anderer Pflichten, wie nur als Beispiel und nicht darauf beschränkt die Kosten zum Entfernen und Wiederaufstellen der Möbel, Vorrichtungen, Maschinen, Unannehmlichkeiten, indirekte Schäden, usw.

Das Vorhandensein von defekten Fliesen entwertet die Qualität der gesamten Lieferung nicht, noch besteht die Pflicht zum Totalaustausch.

Eventuelle Reklamationen des Materials geben dem Käufer nicht das Recht die Zahlungen oder einen Teil davon innerhalb der vereinbarten Fristen einzustellen oder zu verzögern.

Die Dauer der Garantiezeit wird im italienischen Zivilgesetzbuch festgelegt.

GERICHTSSTAND

Für alle Streitfälle im Zusammenhang mit dem Liefervertrag, sowohl von Seiten der Fa. Gardenia Orchidea als auch des Käufers, ist der ausschließlich zuständige Gerichtsstand das Gericht Modena. Die Fa. GARDENIA ORCHIDEA ist auf jeden Fall berechtigt andere Justizbehörden anzurufen.

FORO COMPETENTE

FORO COMPETENTE

FORO COMPETENTE

Материалы GARDENIA ORCHIDEA полностью соответствуют действующим международным нормам. Наша гарантия распространяется исключительно на товар, относящийся к **первому сорту**, в соответствии с нормой UNI EN 14411, на которую мы ссылаемся. Жалобы, относящиеся к товарам других сортов (коммерческие, вторичные, второй сорт, третий сорт, складские запасы и т. д.), не будут рассматриваться.

Попкупатель обязан проверить товар на качество и количество сразу после получения товара, и, в случае наличия рекламаций, известить продавца в письменной форме, направив заказное письмо с уведомлением о получении, не позднее **8 (восемьи) дней** после получения товара; в противном случае какие-либо права утрачиваются.

Попкупатель, направивший рекламацию в указанные сроки, должен хранить всю партию материала, для проведения проверок, которые сочтет нужными выполнить GARDENIA ORCHIDEA; если будут обнаружены дефекты качества материала, покупатель имеет право только на замену материалов с дефектами; любые другие действия (возврат, ремонт или прочее) должны быть утверждены нами предварительно в письменной форме.

Рекламации и запросы о проведении работ по гарантии после укладки не принимаются во внимание, в том случае, если дефект носил очевидный характер (сколы, дефекты поверхности, дефекты размеров, различия в тональности и т. д.). Любая укладка материала, в том числе частичная, представляет собой безусловное принятие товара.

Уточняем, что первый сорт может содержать плитку с дефектами (ISO 10545/2) в количестве 5% (пять процентов) и что тональность поставляемого материала может отличаться от представленного образца, поскольку керамика характеризуется переменным внешним видом.

Рекламации, касающиеся скрытых дефектов, должны быть направлены в письменной форме не позднее **8 (восемьи) дней** после обнаружения дефекта и, в любом случае, в течение года после поставки; при несоблюдении этого условия какие-либо права утрачиваются.

Если жалоба окажется необоснованной, Покупатель должен будет возместить GARDENIA ORCHIDEA все расходы, понесенные в связи с проверкой (командировочные расходы, проживание, экспертиза и т. д.)

В любом случае наша гарантия включает в себя только замену материалов, имеющих дефекты, или ремонт, с полным исключением каких-либо дополнительных и иных обязательств, которые, в качестве указания, но не ограничиваясь, являются стоимостью снятия и повторной установки мебели, приспособлений, машинного оборудования, неудобств, непрямого ущерба и т. д.
Наличие плитки с дефектами не влияет на качество всей поставки, а также не ведет к обязанности заменить поставку полностью.
Возможные рекламации, касающиеся материала, не дают Покупателю права на задержку или приостановку оплаты, полностью или частично, в установленные сроки.
Временные сроки действия гарантии соответствуют срокам, установленным Гражданским кодексом Италии.

КОМПЕТЕНТНЫЙ СУДЕБНЫЙ ОКРУГ

Любые споры, связанные с договором на поставку, как со стороны Gardenia Orchidea, так и со стороны Покупателя, находятся в эксклюзивной компетенции суда г. Модена. GARDENIA ORCHIDEA имеет право обращаться в другие судебные органы.

FORO COMPETENTE

FORO COMPETENTE

FORO COMPETENTE

FORO COMPETENTE

Los materiales de GARDENIA ORCHIDEA están garantizados de conformidad con la normativa internacional actualmente vigente.

Nuestra garantía se limita únicamente a la mercancía suministrada como de **primera selección**, que está sujeta a la norma UNI EN 14411 a la que nos referimos. No se tendrán en cuenta las reclamaciones relacionadas con mercancía de calidad diferente (comercial, secundaria, de segunda, tercera, en stock, etc.).

El comprador tiene la obligación de comprobar la mercancía en términos de calidad y cantidad en el breve plazo desde la recepción de la mercancía y, en caso de reclamación debe enviar una comunicación por escrito con acuse de recibo, dentro y no superados los **8 (ocho) días** desde la recepción de la misma, bajo pena de pérdida de cualquier derecho.

El Comprador que haya enviado una reclamación en tiempo útil debe retener, a disposición de GARDENIA ORCHIDEA y para las comprobaciones que considere oportunas realizar, toda la partida de material y, donde sean comprobados defectos o anomalías de calidad tendrá derecho sólo al reemplazo del material defectuoso; cualquier acción posterior (devolución, reparación u otro) debe ser autorizada previamente por nosotros y por escrito.

Reclamaciones y solicitudes de intervención bajo garantía después de la colocación en obra no serán tomadas en consideración en el caso en el cual el defecto resultase obvio (defectos de superficie, de medidas, diferencias de color, despuntadas, etc.). La colocación, incluso parcial del material, constituye aceptación incondicional de los bienes.

Se precisa que la primera selección puede contener azulejos defectuosos (ISO 10545/2) dentro de un límite del 5% (cinco por ciento) y que el tono del material suministrado puede variar con respecto a la muestra expuesta, siendo la cerámica intrínsecamente variable como aspecto.

Los reclamos atribuidos a defectos ocultos se nos deberán indicar por escrito dentro de los **8 (ocho) días** de haberlos descubierto y, en cualquier caso, dentro de un año de la entrega, bajo pena de pérdida de cualquier derecho.

Si la reclamación resultase infundada, el Comprador deberá resarcir a GARDENIA ORCHIDEA por todos los gastos en que haya incurrido para la comprobación (viajes, alojamiento, pericias, etc.). **En cualquier caso, nuestra garantía comprende solamente el reemplazo del material defectuoso, o la reparación, con expresa exclusión de cualquier otra y diferente obligación, como, a título indicativo pero no limitado, costos de remoción y recolocación del mobiliario, equipamientos, maquinarias, molestias, daños indirectos, etc.**
La presencia de azulejos defectuosos no afecta la calidad de todo el suministro, ni implica la obligación del reemplazo completo.

Eventuales reclamaciones sobre el material no dan derecho al comprador a suspender o retrasar total o parcialmente el pago en los términos pactados.

Los límites temporales de la duración de la garantía quedan establecidos por el código civil italiano.

TRIBUNAL COMPETENTE

Para cualquier controversia, derivada del contrato de suministro, tanto por parte de Gardenia Orchidea como por parte del comprador es de competencia exclusiva del Tribunal de Módena. En facultad de GARDENIA ORCHIDEA adherir a autoridades judiciales diferentes.

FORO COMPETENTE

FORO COMPETENTE

FORO COMPETENTE

GARDENIA ORCHIDEA公司使用的材料，保证符合当前有效的国际标准。我们的保修仅限于提供的一等货物，符合UNI EN 14411标准。这是我们的参考标准。与其它等级（商业，次等，二等，三等，库存等）的货物有关的投诉将不予考虑。买方有义务在收货之后的短期内检验货物质量与数量，若需申诉，须提供书面通知，自收货日期起8（八）天且不超过8（八）天的时间内，以带回执的挂号信方式寄送，否则被视为放弃任何相关权利。

及时提出申诉的买方应妥善货物以提供给GARDENIA ORCHIDEA来审查，并在确认产品的质量问题的或缺陷的情况下有权利获得缺陷材料的更换；任何其他行为（退回、维修或其他)应事先经过本公司的书面授权。对于已进行放置的瓷砖申诉及维修申请，即使产品有着明显缺陷（碎裂，表面缺陷，尺寸缺陷，色泽不统一等），亦不予考虑。一旦进行安装，即使是部分安装，则视为无条件接受产品状况。

有明确指出，第一选择的产品在5%(百分之五)的范围内可以含有缺陷瓷砖（ISO 10545/2），且所提供的材料色泽与展示用的材料色泽可能会有差别，因为陶瓷本身外观上易发生变化。针对隐藏缺陷的申诉应该自发现之日起8（八）天之内向我们发出书面通知，并无论如何自收货之日起不超过一年，否则被视为放弃任何相关权利。

假如相关申诉毫无根据，买方应赔偿GARDENIA ORCHIDEA公司在检验中产生的所有费用(旅费，住宿，专家鉴定等等)

无论如何，本公司的质保仅涉及到检验出有缺陷的材料 的更换，或维修，明确免除更多其他义务，诸如，包含但不限于，搬运及重新安放家具、设备、机器、损伤、间接损失等费用。

部分有缺陷的瓷砖并不会影响整套产品的质量，且不带来更换整套产品的义务。关于材料问题的可能争议并不代表给予买方中止、或者部分或完全推迟按照双方协定付款的权利。质保的期限以意大利民法典的规定为准。

有管辖权的法院

在任何有关供应合同的争议情况下，Gardenia Orchidea公司和买方皆在Modena（摩德纳）法院的管辖之下。无论如何GARDENIA ORCHIDEA公司有权利向不同的司法当局求助。

Direzione e coordinamento a cura di: Ufficio Marketing Gardenia Orchidea

Catalogo: Generale 2020

Stampa: www.golinelli.it

Edito da: Ceramiche Gardenia Orchidea S.p.A., Via Canaletto 27,
41042 Spezzano di Fiorano (Modena), Italia

Edizione: Marzo 2020

“La proprietà intellettuale del presente catalogo è riservata per tutti i Paesi. La traduzione, riproduzione, memorizzazione elettronica e l’adattamento totale o parziale e con qualsiasi mezzo (compresi microfilm e le copie fotostatiche) dei suoi contenuti comporta la violazione dei diritti di copyright di Ceramiche Gardenia Orchidea S.p.A. I prodotti raffigurati nelle immagini del presente catalogo sono protetti secondo la normativa vigente in materia di proprietà industriale”.

“All the intellectual property rights of this catalogue are reserved in all countries. Translation, reproduction in print or electronic form, and adaptation, in whole or in part, using any means (including microfilm and photocopy formats) of the contents of the said catalogue constitute a violation of Ceramiche Gardenia Orchidea S.p.A.’s copyright. The products featured in the photographs in this catalogue are protected by current industrial property legislation.”

- I colori possono risultare falsati dai procedimenti litografici.
- The colours could be altered by the lithographic printing process.
- Les couleurs peuvent résulter faussées par les procédés lithographiques.
- Durch die Lithographie können farbliche Täuschungen entstehen.
- Los colores pueden resultar falseados por los procedimientos litográficos.
- ЦВЕТА МОГУТ БЫТЬ ИСКАЖЕНЫ ВСЛЕДСТВИЕ ЛИТОГРАФИЧЕСКОЙ ОБРАБОТКИ.
- 颜色可通过平版印刷处理而改变



