

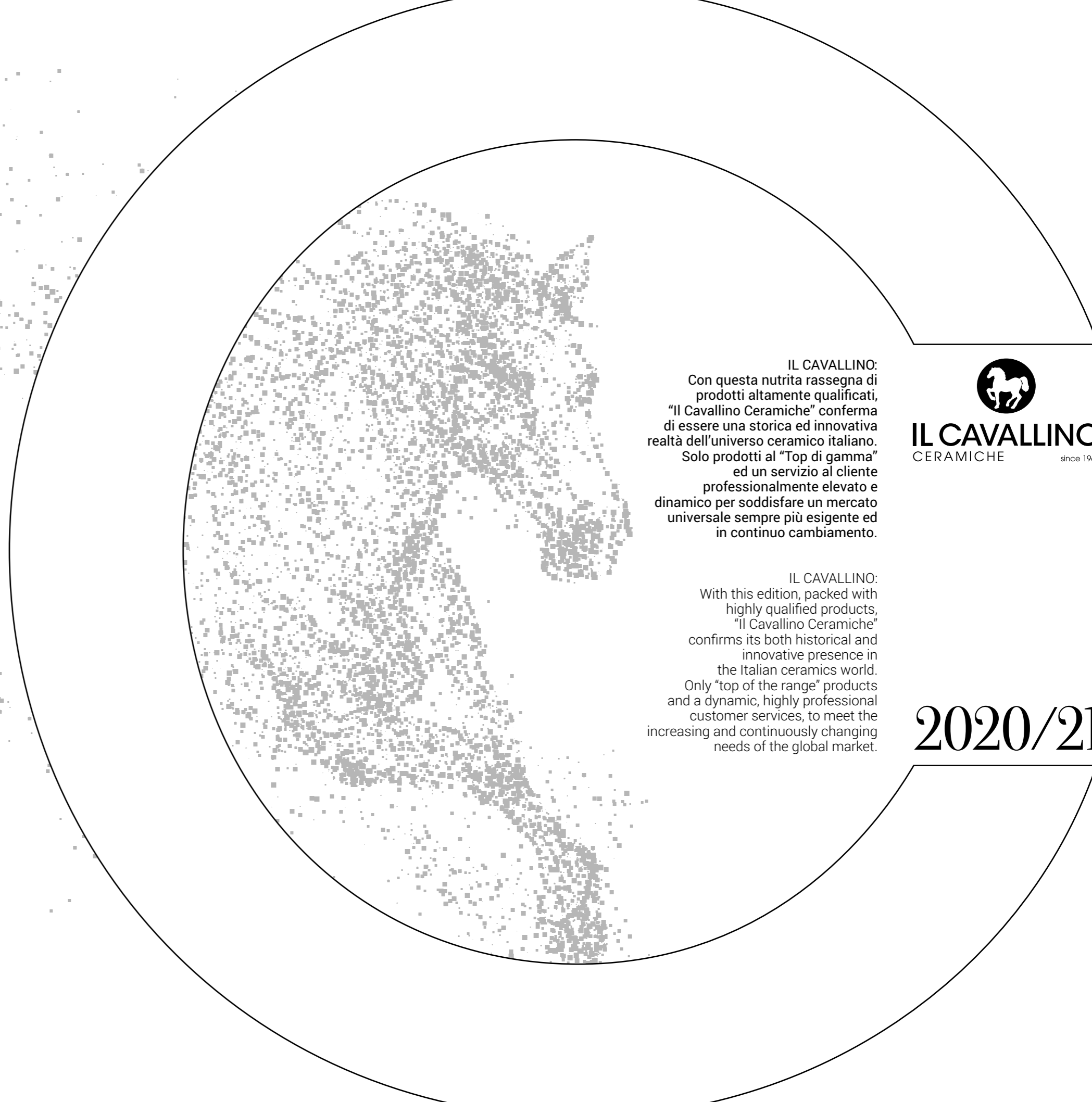

IL CAVALLINO
CERAMICHE

since 1968





IL CAVALLINO:
Con questa nutrita rassegna di prodotti altamente qualificati, "Il Cavallino Ceramiche" conferma di essere una storica ed innovativa realtà dell'universo ceramico italiano. Solo prodotti al "Top di gamma" ed un servizio al cliente professionalmente elevato e dinamico per soddisfare un mercato universale sempre più esigente ed in continuo cambiamento.

IL CAVALLINO:
With this edition, packed with highly qualified products, "Il Cavallino Ceramiche" confirms its both historical and innovative presence in the Italian ceramics world. Only "top of the range" products and a dynamic, highly professional customer services, to meet the increasing and continuously changing needs of the global market.



IL CAVALLINO
CERAMICHE since 1968

2020/21



IL CAVALLINO
CERAMICHE since 1968

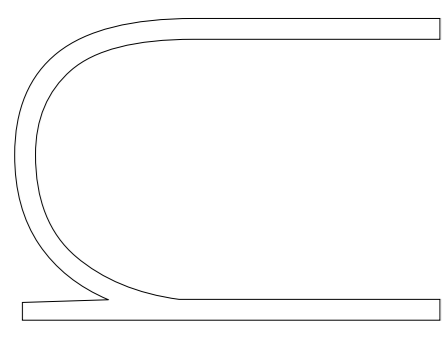
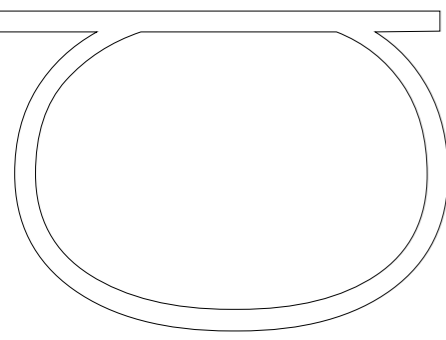
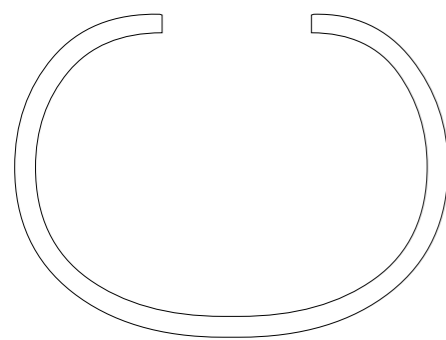
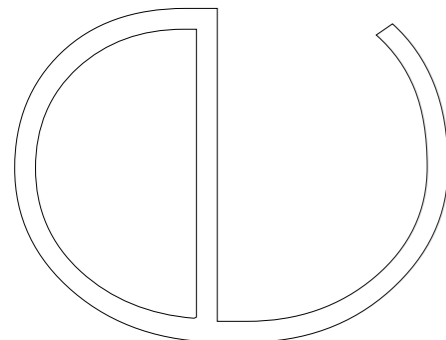

Indice

Index
Index
Inhaltsverzeichnis

SERIE . SERIE . GAMME . SERIE	PAGINA . PAGE . PAGE . SEITE
A	
agadir	62
athena	132
B	
beton	206
C	
caementum	20
caementum FP2	24
camelot	172
carociment	60
chalet	168
colosseo	70
colosseo FP2	74
crystal	218
D	
decapé floor	142
decapé wall	147
decapé FP2	148
devon	212
dimore 20x20 & 20x40	196
durango	96
durango FP2	100
E	
endless	122
endless FP2	126
etna	76
etna FP2	82
etruria	112
F	
fjord	150
fjord FP2	154
frühling dekore	54
frühling dekore FP2	58
G	
grey soul	40
grey soul FP2	46
I	
intarsio	164

SERIE . SERIE . GAMME . SERIE	PAGINA . PAGE . PAGE . SEITE
L	
la leccese	66
le leghe	14
level floor	48
level wall	53
limestone	84
limestone FP2	90
luserna 20x20 & 20x40	192
luxory	128
M	
meteora	26
meteora 20x20 & 20x40	200
meteora FP2	32
metropolitan	10
my s'tile	34
my s'tile FP2	38
modern	210
N	
north wind floor	156
north wind wall	161
north wind FP2	162
P	
pietre	102
R	
rall	184
river	138
S	
santi	110
T	
terraforte	106
terre toscane	178
trevis	220
tribeca	92
tribeca 20x20 & 20x40	194
V	
vals 20x20 & 20x40	188
W	
white marble	118
woody floor	216

Sezione tecnica

Technical section
Section technique
Technischen Teil

indice per formato	4
format index index des formats formateverzeichnis	
lettura del catalogo	6
reading the catalogue la lecture du catalogue benützung des kataloges	
esempi di posa multiformato	69
laying compositions multiformat exemple de pose multiformato verlegemuster multiformato	
esempi di posa 20x20 / 20x40	202
laying compositions 20x20 / 20x40 exemple de pose 20x20 / 20x40 verlegemuster 20x20 / 20x40	
simbologia caratteristiche tecniche	224
symboles technical characteristics symboles des caracteristiques techniques symbole technischen eigenschaften	
coefficiente di attrito (scivolosità)	225
coefficient of friction (slipperiness) coefficient de frottement (antidérapant) rutschfestigkeit	
consigli di posa	226
laying recommendations conseils de pose ratschläge für die verlegung	
consigli per la stuccatura e la pulizia dopo posa	227
recommendations for grouting and cleaning after installation conseils pour le stucage et le nettoyage après la pose ratschläge für die verfugung und erste reinigung nach der verlegung	
pulizia e manutenzione dei prodotti Il Cavallino	228
cleaning and care of Il Cavallino products nettoyage et entretien des articles Il Cavallino reinigung und pflege der produkte von Il Cavallino	
avvertenze	232
warning instructions instructions hinweise	
legenda	234
legend légend zeichenerklärung	
condizioni generali di vendita	235
general conditions of sale conditions générales de vente allgemeine verkaufsbedingungen	
tabella pesi ed imballi	236
sizes weight and packaging mesures poids et emballages tabelle der gewichte und verpackungen	



IL CAVALLINO
CERAMICHE since 1968

Indice sezioni

Section index
Index sections
Inhaltsverzeichnis abschnitte

SERIE . SERIE . GAMME . SERIE	PAGINA . PAGE . PAGE . SEITE
effetto metallo	8
metal-look . effet métallique . metalloptik	
le leghe	14
metropolitan	10
effetto cemento	18
concrete-look . effet ciment . zementoptik	
agadir	62
beton	206
caementum	20
carociment	60
frühling dekore	54
grey soul	40
level floor	48
meteora	26
my s'tile	34
modern	210
effetto pietra	64
stone-look . effet pierre . steinoptik	
colosseo	70
durango	96
etna	76
etruria	112
la leccese	66
limestone	84
pietre	102
santi	110
terraforte	106
trevis	220
tribeca	92
vals	188
effetto marmo	116
marble-look . effet marbre . marmoroptik	
athena	132
crystal	218
endless	122
luxory	128
white marble	118
effetto legno	136
wood-look . effet bois . holzoptik	
chalet	168
decapé floor	142
devon	212
fjord	150
intarsio	164
north wind floor	156
river	138
woody floor	216

SERIE . SERIE . GAMME . SERIE	PAGINA . PAGE . PAGE . SEITE
effetto cotto	170
cotto-look . effet cotto . cottooptik	
camelot	172
terre toscane	178
technical project	
caementum FP2	24
colosseo FP2	74
decapé FP2	148
durango FP2	100
endless FP2	126
etna FP2	82
fjord FP2	154
frühling dekore FP2	58
grey soul FP2	46
limestone FP2	90
meteora FP2	32
my s'tile FP2	38
north wind FP2	162
rall	184
20x20 & 20x40	186
dimore 20x20 & 20x40	196
luserna 20x20 & 20x40	192
meteora 20x20 & 20x40	200
tribeca 20x20 & 20x40	194
vals 20x20 & 20x40	188
rivestimenti	
wall tiles . faiences . wandfliesen	
decapé wall	147
level wall	53
north wind wall	161
	204
beton	206
crystal	218
devon	212
modern	210
trevis	220
woody floor	216

Lettura del catalogo

Feading the catalogue
La lecture du catalogue
Benützung des kataloges

2 grès porcellanato impasto colorato
color body porcelain stoneware . grès cérame coloré dans la masse . durchgefärbtes feinsteinzeug



Formati
Sizes - Formats - Formate

2 **R9** **10mm**
tutti i colori / all colors

90x90 cm R / 36"x36" R

3 **R9** **10mm**
tutti i colori / all colors

61,3x122,6 cm R / 24"x48" R
61,3x122,6 cm R / 24"x48" R - DECORO

R9 **10mm** **R9** **9mm**
tutti i colori / all colors tutti i colori / all colors

30,8x61,5 cm N / 12"x24" N
30,4x61,0 cm R / 12"x24" R
30,4x61,0 cm R / 12"x24" R - DECORO

61,0x61,0 cm R / 24"x24" R

Colori
Colours - Couleurs - Farbe

5

WHITE

GREY

DARK GREY

ANTHRACITE

4 **N** NATURALE NATURAL **R** RETTIFICATO RECTIFIED

Lettura del catalogo

Feading the catalogue
La lecture du catalogue
Benützung des kataloges

1 LEVEL

6

5 white

3

90x90 cm 36"x36"	R A000
61,3x122,6 cm 24"x48"	R A000
61,3x122,6 cm 24"x48" DECORO	R A000
61,0x61,0 cm 24"x24"	R A000
30,8x61,5 cm 12"x24"	N A000
30,4x61,0 cm 12"x24"	R A000
30,4x61,0 cm 12"x24" DECORO	R A000

4 **9**

decori - decors - décors - dekors

7 mosaico monocolor 36 tessere 5x5 **P000** **0**
30x30 cm 12"x12"



5 white

pezzi speciali - special pieces -
pièces spéciales - formteile

7 battiscopa
6,5x61,0 cm 2 1/2"x24" **P000** **00**



5 white

1 Nome serie
Series name
Nom série
Serienbezeichnung

2 Caratteristiche tecniche
Technical characteristics
Caractéristiques techniques
Technische daten

3 Formati
Sizes
Formats
Formate

4 Finitura
Product types
Finition produit
Ausführung des Produkts

5 Colore
Colour
Couleur
Farbe

6 Tacche colore
Colour samples
Couleurs disponibles
Farbmuster

7 Descrizione articolo
Product types
Description de l'article
Beschreibung des artikel

8 Pz/scatola
Pieces/box
Pièces/bôte
Stücke/karton

9 Codice fascia prezzo al metro quadro
Price range code per square meter
Code fourchette de prix par mètre carré
Preisspanne Code pro Quadratmeter

10 Codice fascia prezzo al pezzo
Price range code per piece
Code fourchette de prix par pièce
Preisspanne Code pro Stück



IL CAVALLINO
CERAMICHE since 1968

effetto metallo - metal-look - effet métallique - metalloptik



<u>le leghe</u>	14
<u>metropolitan</u>	10



IL CAVALLINO
CERAMICHE since 1968

METROPOLITAN

effetto metallo
metal-look
effet métallique
metalloptik

grès porcellanato impasto colorato
color body porcelain stoneware . grès cérame coloré dans la masse . durchgefärbtes feinsteinzeug



Formati Sizes - Formats - Formate

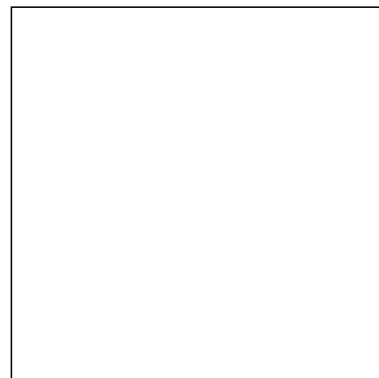

R10 nichel, iron, blue

122,6x122,6 cm R / 48"x48" R

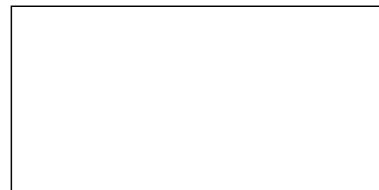

R10 nichel, iron, blue

61,3x122,6 cm R / 24"x48" R

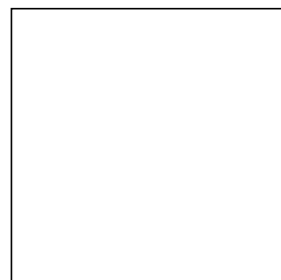

R10 tutti i colori / all colors

90x90 cm R / 36"x36" R



R10 tutti i colori / all colors

61,0x61,0 cm R / 24"x24" R

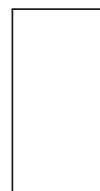

R10 nichel, iron, blue

30,4x61,0 cm R / 12"x24" R

Colori Colours - Couleurs - Farbe



NICHEL



CORTEN



IRON



BLUE



floor: Iron 122,6x122,6 cm . 48"x48" R
wall: Nichel 61,3x122,6 cm . 24"x48" R

METROPOLITAN



nichel

122,6x122,6 cm 48"x48"	R	A230
90x90 cm 36"x36"	R	A220
61,3x122,6 cm 24"x48"	R	A180
61,0x61,0 cm 24"x24"	R	A192
30,4x61,0 cm 12"x24"	R	A110



corten

90x90 cm 36"x36"	R	A220
61,0x61,0 cm 24"x24"	R	A192



iron

122,6x122,6 cm 48"x48"	R	A230
90x90 cm 36"x36"	R	A220
61,3x122,6 cm 24"x48"	R	A180
61,0x61,0 cm 24"x24"	R	A192
30,4x61,0 cm 12"x24"	R	A110



blue

122,6x122,6 cm 48"x48"	R	A230
90x90 cm 36"x36"	R	A220
61,3x122,6 cm 24"x48"	R	A180
61,0x61,0 cm 24"x24"	R	A192
30,4x61,0 cm 12"x24"	R	A110

METROPOLITAN

decori - decors - décors - dekors

mosaico monocolore 81 tessere 3x3 - 30x30 cm 12"x12" 7 **P73**

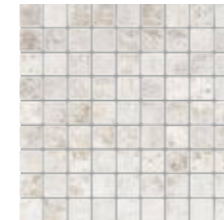

nichel

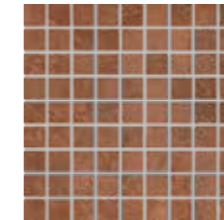

corten

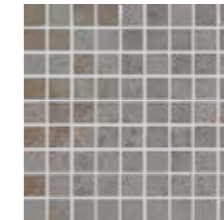

iron

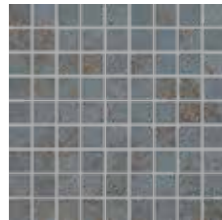

blue

mosaico asimmetrico 18 pz - 30x30 cm 12"x12" 9 **P77**



nichel

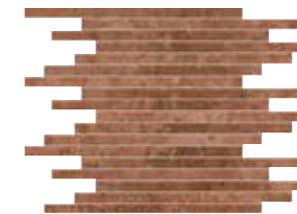

corten



iron



blue

pezzi speciali - special pieces - pièces spéciales - formteile

step
30,4x61,0 cm 12"x24" **P90**

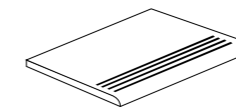

nichel

iron

blue

battiscopa
*6,5x122,6 cm 2 1/2"x48" **P05** 10
*6,5x90 cm 2 1/2"x36" **P03** 10



*nichel

*iron

*blue

*corten

angolare costa retta dx/sx
*34x122,6x4 cm 13"x48"x1 3/4" **P41**
*34x34x4 cm 13"x13"x1 3/4" **P40**

vista frontale



/ nichel

• corten

/ iron

/ blue

vista dal retro



gradino costa retta
*34x122,6x4 cm 13"x48"x1 3/4" **P32**
*34x61,0x4 cm 13"x24"x1 3/4" **P31**



/ nichel

• corten

/ iron

/ blue

Note - Notes - Notes - Anmerkungen
I battiscopa vengono venduti a pz. e a scatola completa. Tutti gli altri pezzi speciali vengono venduti al pezzo. I gradini vengono prodotti solo su ordinazione (tempo minimo di consegna 20 gg lavorativi).
All skirting priced per piece, are sold in full box. All other special trims are sold by piece. Steps are produced only on request (minimum delivery terms of 20 days).
Les plinthes sont vendues la pièce et par boîte complète. Les autres pièces spéciales sont vendus la pièce. Le plat de marche sont produit sur demande (délai minimum de 20 jours).
Die Sockelleisten werden pro Stk. und Vollen Kartons verkauft. Stufen und Stufenecken werden nur auf Bestellung produziert (Lieferzeiten mindesten 20 arbeitstagen ab Auftragserteilung).

LE LEGHE

grès porcellanato impasto colorato
color body porcelain stoneware . grès cérame coloré dans la masse . durchgefärbtes Feinsteinzeug

effetto metallo
metal-look
effet métallique
metalloptik



Formati Sizes - Formats - Formate

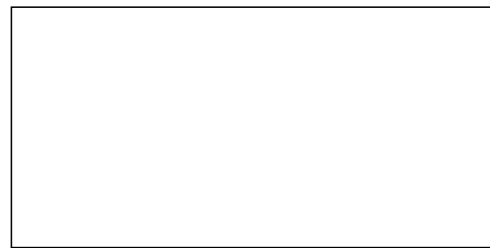

stagno, platino

80,0x160,0 cm R / 31"x62" R

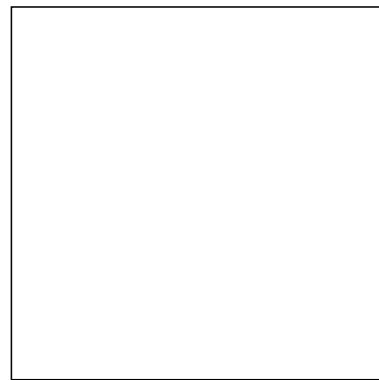

stagno, platino

122,6x122,6 cm R / 48"x48" R



tutti i colori / all colors

61,3x122,6 cm R / 24"x48" R

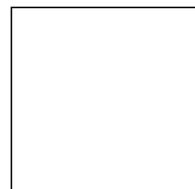

tutti i colori / all colors

61,0x61,0 cm R / 24"x24" R

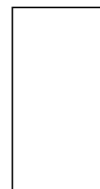

tutti i colori / all colors

30,4x61,0 cm R / 12"x24" R

Colori Colours - Couleurs - Farbe

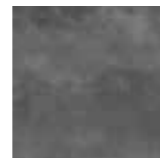

COBALTO



STAGNO



PLATINO



NIELLO



BRONZO



floor: Niello 61,0x61,0 cm . 24"x24" R
wall: Stagno 61,3x122,6 cm . 24"x48" R

LE LEGHE

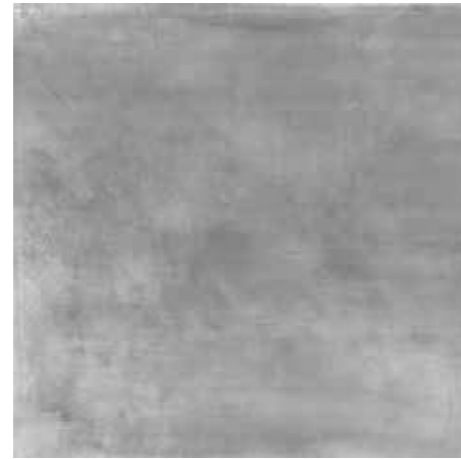

stagno

122,6x122,6 cm 48"x48"	R A230
80,0x160,0 cm 31"x62"	R A210
61,3x122,6 cm 24"x48"	R A180
61,0x61,0 cm 24"x24"	R A192
30,4x61,0 cm 12"x24"	R A110

platino

122,6x122,6 cm 48"x48"	R A230
80,0x160,0 cm 31"x62"	R A210
61,3x122,6 cm 24"x48"	R A180
61,0x61,0 cm 24"x24"	R A192
30,4x61,0 cm 12"x24"	R A110

niello

61,3x122,6 cm 24"x48"	R A180
61,0x61,0 cm 24"x24"	R A192
30,4x61,0 cm 12"x24"	R A110



cobalto

61,3x122,6 cm 24"x48"	R A180
61,0x61,0 cm 24"x24"	R A192
30,4x61,0 cm 12"x24"	R A110

bronzo

61,3x122,6 cm 24"x48"	R A180
61,0x61,0 cm 24"x24"	R A192
30,4x61,0 cm 12"x24"	R A110

LE LEGHE

decori - decors - décors - dekors

mosaico monocolore 81 tessere 3x3 - 30x30 cm 12"x12" **7** **P73**



stagno

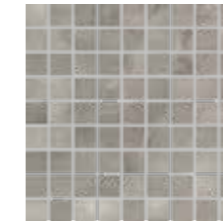

platino

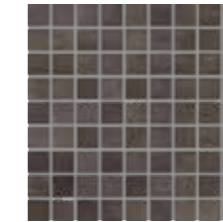

niello

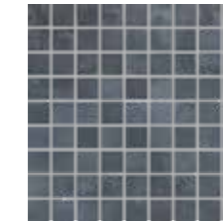

cobalto

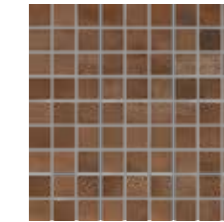

bronzo

mosaico asimmetrico 18 pz - 30x30 cm 12"x12" **9** **P77**



stagno



platino



niello



cobalto



bronzo

pezzi speciali - special pieces - pièces spéciales - formteile

step
30,4x61,0 cm 12"x24" **R** **P90**

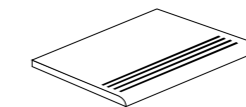

stagno

cobalto

platino

niello

bronzo

battiscopa
6,5x122,6 cm 2 1/2"x48" **R** **P05** **10**



stagno

cobalto

platino

niello

bronzo

angolare costa retta dx/sx
34x122,6x4 cm 13"x48"x1 3/4" **R** **P41**
34x34x4 cm 13"x13"x1 3/4" **R** **P40**

vista frontale



vista dal retro

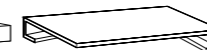

stagno

cobalto

platino

niello

bronzo

gradino costa retta
34x122,6x4 cm 13"x48"x1 3/4" **R** **P32**
34x61,0x4 cm 13"x24"x1 3/4" **R** **P31**



stagno

cobalto

platino

niello

bronzo

Note - Notes - Notes - Anmerkungen

I battiscopa vengono venduti a pz. e a scatola completa. Tutti gli altri pezzi speciali vengono venduti al pezzo. I gradini vengono prodotti solo su ordinazione (tempo minimo di consegna 20 gg lavorativi).
All skirting priced per piece, are sold in full box. All other special trims are sold by piece. Steps are produced only on request (minimum delivery terms of 20 days).
Les plinthes sont vendues la pièce et par boîte complète. Les autres pièces spéciales sont vendus la pièce. Le plat de marche sont produit sur demande (délai minimum de 20 jours).
Die Sockelleisten werden pro Stk. und Vollen Kartons verkauft. Stufen und Stufenecken werden nur auf Bestellung produziert (Lieferzeiten mindesten 20 arbeitstagen ab Auftragserteilung).

effetto cemento - concrete-look - effet ciment - zementoptik



agadir	62
caementum	20
caementum FP2	24
carociment	60
frühling dekore	54
frühling dekore FP2	58
grey soul	40
grey soul FP2	46
level floor	48
level floor	53
meteora	26
meteora FP2	32
my s'tile	34
my s'tile FP2	38



IL CAVALLINO
CERAMICHE since 1968





CAEMENTUM

grès porcellanato impasto colorato
color body porcelain stoneware . grès cérame coloré dans la masse . durchgefärbtes Feinsteinzeug

effetto cemento
concrete-look
effet ciment
zementoptik

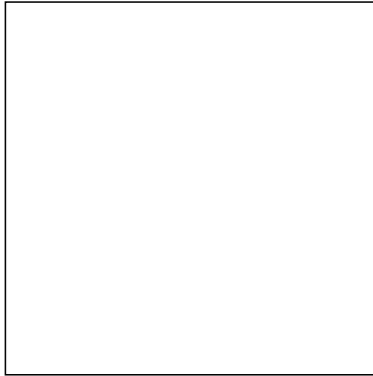
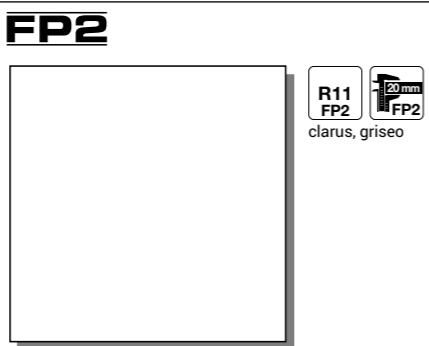

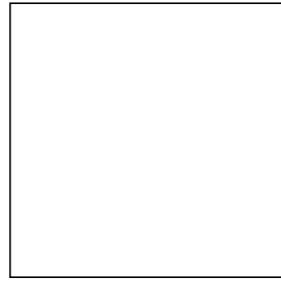
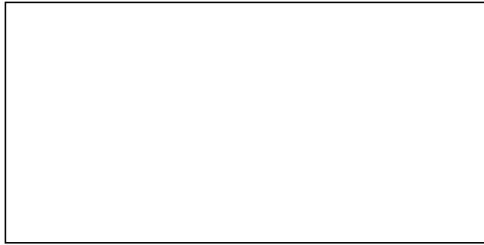
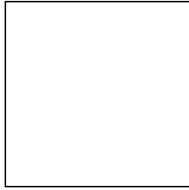
Formati Sizes - Formats - Formate

 122,6x122,6 cm R / 48"x48" R R10 albus, clarus, pulis, griseo	 FP2 90x90 cm RS / 36"x36" RS R11 FP2 clarus, griseo	
 61,3x122,6 cm R / 24"x48" R R10 tutti i colori / all colors	 90x90 cm R / 36"x36" R R10 clarus, pulvis, griseo	
 80,0x160,0 cm R / 31"x62" R R10 albus, clarus, pulis, griseo		
 61,0x61,0 cm R / 24"x24" R 61,0x61,0 cm R - outdoor/ 24"x24" R - outdoor R10 tutti i colori / all colors R11 outdoor clarus, pulvis, griseo	 30,4x61,0 cm R / 12"x24" R R10 tutti i colori / all colors	 45,5x45,5 cm N / 18"x18" N R10 clarus, pulvis, griseo

R RETTIFICATO RECTIFIED
 RS RETTIFICATO/STRUTTURATO RECTIFIED/TEXTURED
 N NATURALE NATURAL

Colori Colours - Couleurs - Farbe



floor: Griseo 122,6x122,6 cm . 48"x48" R
wall: Clarus 61,3x122,6 cm . 24"x48" R

CAEMENTUM

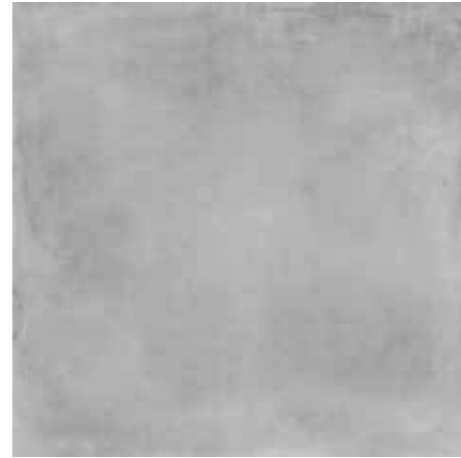

albus

122,6x122,6 cm 48"x48"	R	A230
80,0x160,0 cm 31"x62"	R	A210
61,3x122,6 cm 24"x48"	R	A180
61,0x61,0 cm 24"x24"	R	A192
30,4x61,0 cm 12"x24"	R	A110

clarus

122,6x122,6 cm 48"x48"	R	A230
90x90 cm 36"x36"	R	A220
80,0x160,0 cm 31"x62"	R	A210
61,3x122,6 cm 24"x48"	R	A180
61,0x61,0 cm 24"x24"	R	A192
61,0x61,0 cm 24"x24" OUTDOOR	R	A193
45,5x45,5 cm 18"x18"	N	A160
30,4x61,0 cm 12"x24"	R	A110

pulvis

122,6x122,6 cm 48"x48"	R	A230
90x90 cm 36"x36"	R	A220
80,0x160,0 cm 31"x62"	R	A210
61,3x122,6 cm 24"x48"	R	A180
61,0x61,0 cm 24"x24"	R	A192
61,0x61,0 cm 24"x24" OUTDOOR	R	A193
45,5x45,5 cm 18"x18"	N	A160
30,4x61,0 cm 12"x24"	R	A110

FP2

90x90 cm 36"x36" FP2	RS	A225
----------------------	----	------

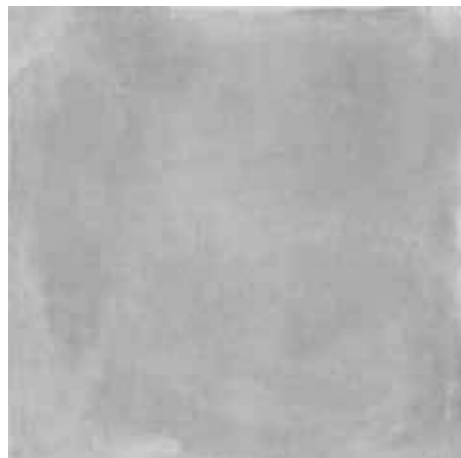

griseo

122,6x122,6 cm 48"x48"	R	A230
90x90 cm 36"x36"	R	A220
80,0x160,0 cm 31"x62"	R	A210
61,3x122,6 cm 24"x48"	R	A180
61,0x61,0 cm 24"x24"	R	A192
61,0x61,0 cm 24"x24" OUTDOOR	R	A193
45,5x45,5 cm 18"x18"	N	A160
30,4x61,0 cm 12"x24"	R	A110



furvus

61,3x122,6 cm 24"x48"	R	A180
61,0x61,0 cm 24"x24"	R	A192
30,4x61,0 cm 12"x24"	R	A110

FP2

90x90 cm 36"x36" FP2	RS	A225
----------------------	----	------

CAEMENTUM

decori - decors - décors - dekors

mosaico monocolori 81 tessere 3x3 - 30x30 cm 12"x12" 7 **P73**

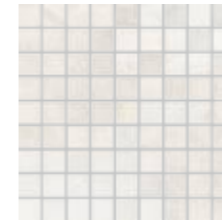

albus



clarus

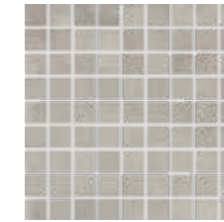

pulvis

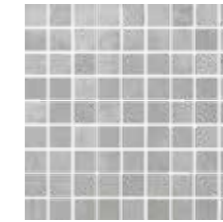

griseo

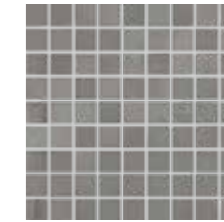

furvus

pezzi speciali - special pieces - pièces spéciales - formteile

elemento "L" monolitico outdoor **P51** 2
15x61x4 cm 6"x24"x1 3/4"



clarus



pulvis



griseo

battiscopa **P05** 10
6,5x122,6 cm 2 1/2"x48"



albus



clarus



griseo

furvus

step **P90**
30,4x61,0 cm 12"x24"

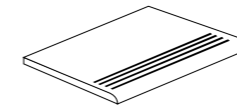

albus

clarus

pulvis

griseo

furvus

gradino costa retta **P32** **P31**
34x122,6x4 cm 13"x48"x1 3/4"
34x61,0x4 cm 13"x24"x1 3/4"

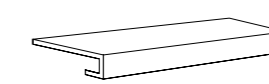

albus

clarus

pulvis

griseo

furvus

angolare costa retta dx/sx **P41** **P40**
34x122,6x4 cm 13"x48"x1 3/4"
34x34x4 cm 13"x13"x1 3/4"

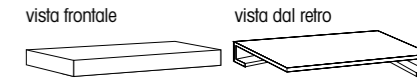

albus

clarus

pulvis

griseo

furvus

Note - Notes - Notes - Anmerkungen
I battiscopa e gli elementi "L" vengono venduti a pz. e a scatola completa. Tutti gli altri pezzi speciali vengono venduti al pezzo. I gradini vengono prodotti solo su ordinazione (tempo minimo di consegna 20 gg lavorativi).
All skirting and monolithic L elements, priced per piece, are sold in full box. All other special trims are sold by piece. Steps are produced only on request (minimum delivery terms of 20 days).
Les plinthes et élément "L" sont vendues la pièce et par boîte complète. Les autres pièces spéciales sont vendus la pièce. Le plat de marche sont produit sur demande (délai minimum de 20 jours).
Die Sockelleisten und Stufen werden pro Stk. und Vollen Kartons verkauft. Stufen und Stufenecken werden nur auf Bestellung produziert (Lieferzeiten mindesten 20 arbeitstagen ab Auftragserteilung).

CAEMENTUM **FP2**

technical project
FP2
outdoor



clarus

90x90 cm 36"x36" **FP2**

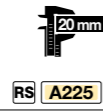

griseo

90x90 cm 36"x36" **FP2**



FP2 pezzi speciali - special pieces - pièces spéciales - formteile

elemento "L"
45x90x5 cm 18"x36"x2" **RS P101**

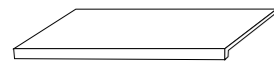

clarus
griseo

angolare elemento "L"
45x90x5 cm 18"x36"x2" **RS P104**



clarus
griseo

griglia
20x90 cm 8"x36" **RS P118**

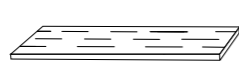

clarus
griseo

griglia angolo
20x90 cm 8"x36" **RS P108 COPPIA**



clarus
griseo

round lineare
45x90 cm 18"x36" **RS P111**

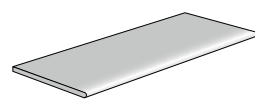

clarus
griseo

round angolare
45x90 cm 18"x36" **RS P120 COPPIA**

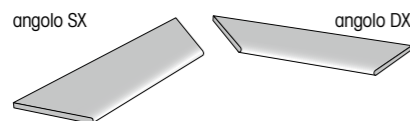

clarus
griseo

angolo bordo tondo
45x90 cm 18"x36" **RS P115**

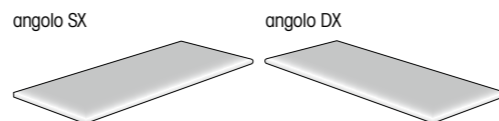

clarus
griseo

Note - Notes - Notes - Anmerkungen

I pezzi speciali FP2 vengono venduti al pezzo e solo su ordinazione (tempo minimo di consegna 20 gg lavorativi dall'ordine)
The special pieces FP2 are sold by piece and only on request (minimum delivery time 20 working days from date of order).
Les pièces spéciales FP2 sont vendus à la pièce et uniquement sur commande (délai minimum de livraison 20 jours ouvrés à partir de la commande).
Spezial Teile FP2 sind pro Stück verkauft und nur auf Bestellungen produziert. (Lieferzeiten mindesten 20 arbeitstage ab Auftragbestätigung)

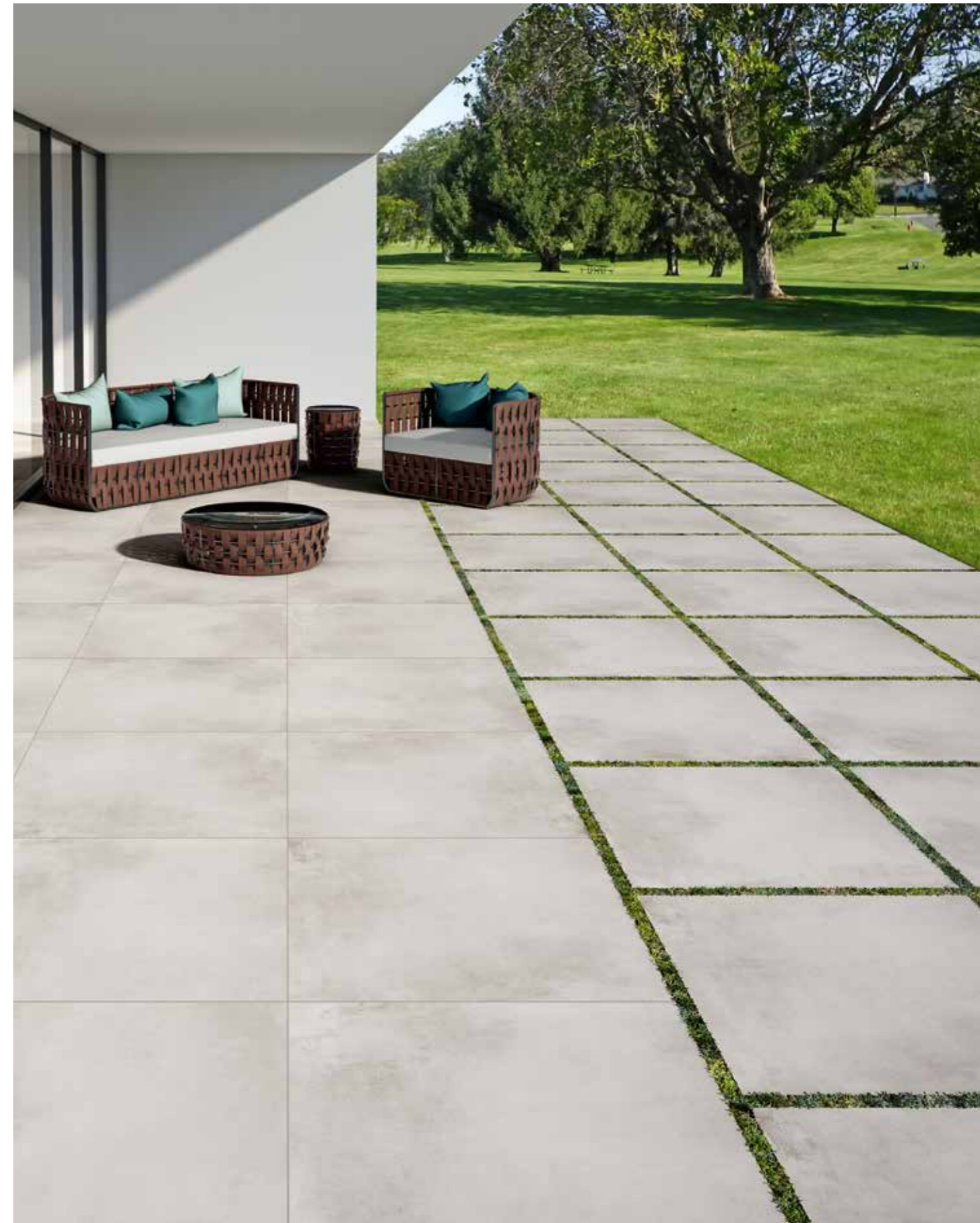

FP2 Clarus
90x90 cm . 36"x36" **RS**

METEORA

grès porcellanato impasto colorato

color body porcelain stoneware . grès cérame coloré dans la masse . durchgefärbtes feinsteinzeug
90x90 cm . 36"x36" - 61,5x61,5 cm . 24"x24" - 61,0x61,0 cm . 24"x24" - 30,8x61,5 cm . 12"x24"

grès porcellanato

porcelain stoneware . grès cérame . feinsteinzeug
20x40 cm . 8"x16" - 20x20 cm . 8"x8" - 15,1x30,6 cm . 6"x12"

Formati

Sizes - Formats - Formate

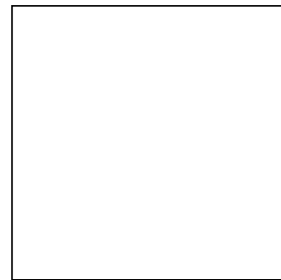

R10
tutti i colori / all colors

90x90 cm RS / 36"x36" RS

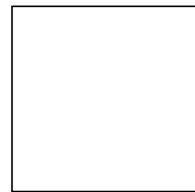

R10
tutti i colori / all colors
R11 outdoor
beige, grigio, mix

61,5x61,5 cm NS / 24"x24" NS
61,5x61,5 cm NS - outdoor/
24"x24" NS - outdoor
61,0x61,0 cm RS / 24"x24" RS
61,0x61,0 cm RS - DECORO/
24"x24" RS - DECORO



R10
tutti i colori / all colors

30,8x61,5 cm NS / 12"x24" NS

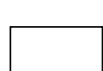

R11 outdoor
beige, cotto, bianco, mix

15,1x30,6 cm NS - outdoor/
6"x12" NS - outdoor

FP2

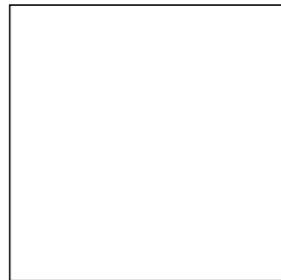

R11 FP2
beige, cotto,
grigio, mix

FP2 90x90 cm RS / 36"x36" RS

FP2 90x90 cm RS - DECORO/
36"x36" RS - DECORO

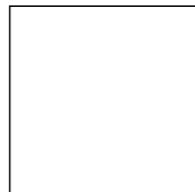

R11 FP2
beige, grigio, mix

FP2 61,0x61,0 cm RS / 24"x24" RS

FP2 61,0x61,0 cm RS - DECORO/
24"x24" RS - DECORO

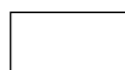

R11 outdoor
grigio, beige, cotto

20x40 cm NS - outdoor/
8"x16" NS - outdoor



R11 outdoor
grigio, beige, cotto

20x20 cm NS - outdoor/
8"x8" NS - outdoor



R10
*beige, cotto,
bianco, mix

*20x20 cm NS / 8"x8" NS
*20x20 cm NS - DECORO /
8"x8" NS - DECORO
*20x20 cm NS - outdoor/
8"x8" NS - outdoor

NS NATURALE/STRUTTURATO
NATURAL/TEXTURED
RS RETTIFICATO/STRUTTURATO
RECTIFIED/TEXTURED

effetto cemento
concrete-look
effet ciment
zementoptik



Colori

Colours - Couleurs - Farbe



BEIGE

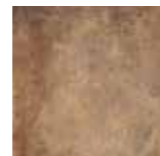

COTTO



BIANCO



GRIGIO



MIX







indoor: Grigio 90x90 cm . 36"x36" RS
outdoor: Grigio FP2 90x90 cm . 36"x36" RS

METEORA



beige





90x90 cm 36"x36"	RS	A220
61,5x61,5 cm 24"x24"	NS	A190
61,5x61,5 cm 24"x24" OUTDOOR	NS	A191
61,0x61,0 cm 24"x24"	RS	A192
61,0x61,0 cm 24"x24" DECORO	RS	A194
30,8x61,5 cm 12"x24"	NS	A140
20x40 cm 8"x16" OUTDOOR 	NS	A51
20x20 cm 8"x8" OUTDOOR 	NS	A43
20x20 cm 8"x8" 	NS	A40
20x20 cm 8"x8" DECORO 	NS	A42
15,1x30,6 cm 6"x12" OUTDOOR	NS	A01

FP2

90x90 cm 36"x36" FP2	RS	A225
90x90 cm 36"x36" DECORO FP2	RS	A226
61,0x61,0 cm 24"x24" FP2	RS	A198
61,0x61,0 cm 24"x24" DECORO FP2	RS	A199



cotto



90x90 cm 36"x36"	RS	A220
61,5x61,5 cm 24"x24"	NS	A190
61,0x61,0 cm 24"x24"	RS	A192
61,0x61,0 cm 24"x24" DECORO	RS	A194
30,8x61,5 cm 12"x24"	NS	A140
20x40 cm 8"x16" OUTDOOR 	NS	A51
20x20 cm 8"x8" OUTDOOR 	NS	A43
20x20 cm 8"x8" 	NS	A40
20x20 cm 8"x8" DECORO 	NS	A42
15,1x30,6 cm 6"x12" OUTDOOR	NS	A01

FP2

90x90 cm 36"x36" FP2	RS	A225
90x90 cm 36"x36" DECORO FP2	RS	A226





bianco

90x90 cm 36"x36"	RS	A220
61,5x61,5 cm 24"x24"	NS	A190
61,0x61,0 cm 24"x24"	RS	A192
61,0x61,0 cm 24"x24" DECORO	RS	A194
30,8x61,5 cm 12"x24"	NS	A140
20x20 cm 8"x8" 	NS	A40
20x20 cm 8"x8" DECORO 	NS	A42
20x20 cm 8"x8" OUTDOOR 	NS	A46
15,1x30,6 cm 6"x12" OUTDOOR	NS	A01



grigio

90x90 cm 36"x36"	RS	A220
61,5x61,5 cm 24"x24"	NS	A190
61,5x61,5 cm 24"x24" OUTDOOR	NS	A191
61,0x61,0 cm 24"x24"	RS	A192
61,0x61,0 cm 24"x24" DECORO	RS	A194
30,8x61,5 cm 12"x24"	NS	A140
20x40 cm 8"x16" OUTDOOR 	NS	A51
20x20 cm 8"x8" OUTDOOR 	NS	A43



FP2

90x90 cm 36"x36" FP2	RS	A225
90x90 cm 36"x36" DECORO FP2	RS	A226
61,0x61,0 cm 24"x24" FP2	RS	A198
61,0x61,0 cm 24"x24" DECORO FP2	RS	A199

METEORA



mix

90x90 cm 36"x36"	RS	A220
61,5x61,5 cm 24"x24"	NS	A190
61,5x61,5 cm 24"x24" OUTDOOR	NS	A191
61,0x61,0 cm 24"x24"	RS	A192
61,0x61,0 cm 24"x24" DECORO	RS	A194
30,8x61,5 cm 12"x24"	NS	A140
20x20 cm 8"x8" 	NS	A40
20x20 cm 8"x8" DECORO 	NS	A42
20x20 cm 8"x8" OUTDOOR 	NS	A46
15,1x30,6 cm 6"x12" OUTDOOR	NS	A01

FP2

90x90 cm 36"x36" FP2	RS	A225
90x90 cm 36"x36" DECORO FP2	RS	A226
61,0x61,0 cm 24"x24" FP2	RS	A198
61,0x61,0 cm 24"x24" DECORO FP2	RS	A199

METEORA

decori - decors - décors - dekors

decoro 61,0x61,0 cm 24"x24" **RS** **mix** - 20x20 cm 8"x8" **NS** **mix** - 90x90 cm 36"x36" **FP2** **RS** **mix** - 61,0x61,0 cm 24"x24" **FP2** **RS** **mix**

20 soggetti diversi, miscelazione casuale. Disponibile in tutti i colori. - 20 assorted motifs, random mix. Available in all colours.
20 sujets différents, mélange aléatoire. Disponible dans toutes les gammes de couleur. - 20 verschiedene Motive, Zufallsmischung. In allen Farben verfügbar.



beige
61,0x61,0 cm 24"x24" DECORO **RS** **A194**
20x20 cm 8"x8" DECORO **NS** **A42**

cotto
61,0x61,0 cm 24"x24" DECORO **RS** **A194**
20x20 cm 8"x8" DECORO **NS** **A42**

FP2
90x90 cm 36"x36" DECORO **FP2** **RS** **A226**
61,0x61,0 cm 24"x24" DECORO **FP2** **RS** **A199**

FP2
90x90 cm 36"x36" DECORO **FP2** **RS** **A226**
61,0x61,0 cm 24"x24" DECORO **FP2** **RS** **A199**



bianco
61,0x61,0 cm 24"x24" DECORO **RS** **A194**
20x20 cm 8"x8" DECORO **NS** **A42**

grigio
61,0x61,0 cm 24"x24" DECORO **RS** **A194**
20x20 cm 8"x8" DECORO **NS** **A42**

FP2
90x90 cm 36"x36" DECORO **FP2** **RS** **A226**
61,0x61,0 cm 24"x24" DECORO **FP2** **RS** **A199**

mix
61,0x61,0 cm 24"x24" DECORO **RS** **A194**
20x20 cm 8"x8" DECORO **NS** **A42**

FP2
90x90 cm 36"x36" DECORO **FP2** **RS** **A226**
61,0x61,0 cm 24"x24" DECORO **FP2** **RS** **A199**

METEORA

decori - decors - décors - dekors

mosaico mix 81 tessere 3x3 - 30x30 cm 12"x12" **NS** **7** **P73**

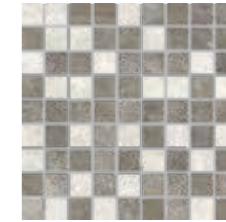

mix cold
bianco, grigio, mix



mix warm
bianco, beige, cotto

mosaico asimmetrico 18 pz - 30x30 cm 12"x12" **NS** **9** **P77**



beige

cotto

bianco

grigio

mix

pezzi speciali - special pieces - pièces spéciales - formteile

elemento "L" monolitico outdoor **NS** **4** **P50**
15x30x4 cm 6"x12"x1 3/4"

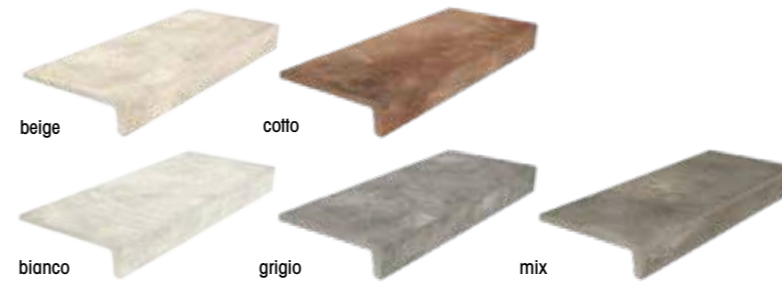

beige

cotto

bianco

grigio

mix

battiscopa
*6,5x61,0 cm 2 1/2"x24" **RS** **P07** **12**
*6,5x20 cm 2 1/2"x8" **NS** **P01** **30**



*beige

*cotto

*bianco

*grigio

*mix

step
30,8x61,5 cm 12"x24" **NS** **P92**

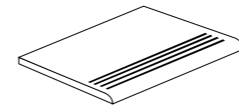

beige

cotto

bianco

grigio

mix

gradino costa retta
34x61,5x4 cm 13"x24"x1 3/4" **NS** **P31**

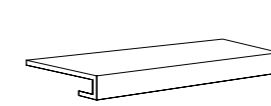

beige

cotto

bianco

grigio

mix

angolare costa retta dx/sx
34x34x4 cm 13"x13"x1 3/4" **NS** **P40**

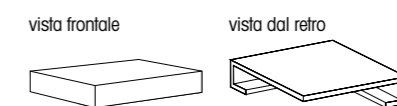

vista frontale

vista dal retro

beige

cotto

bianco

grigio

mix

Note - Notes - Notes - Anmerkungen
I battiscopa e gli elementi "L" vengono venduti a pz. e a scatola completa. Tutti gli altri pezzi speciali vengono venduti al pezzo. I gradini vengono prodotti solo su ordinazione (tempo minimo di consegna 20 gg lavorativi).
All skirting and monolithic L elements, priced per piece, are sold in full box. All other special trims are sold by piece. Steps are produced only on request (minimum delivery terms of 20 days).
Les plinthes et élément "L" sont vendues la pièce et par boîte complète. Les autres pièces spéciales sont vendus la pièce. Le plat de marche sont produit sur demande (délai minimum de 20 jours).
Die Sockelleisten und Stufen werden pro Stk. und Vollen Kartons verkauft. Stufen und Stufenecken werden nur auf Bestellung produziert (Lieferzeiten mindesten 20 arbeitstagen ab Auftragserteilung).

METEORA **FP2**

technical project
FP2
outdoor



beige

90x90 cm 36"x36" FP2	RS A225
90x90 cm 36"x36" DECORO FP2	RS A226
61,0x61,0 cm 24"x24" FP2	RS A198
61,0x61,0 cm 24"x24" DECORO FP2	RS A199



caffè

90x90 cm 36"x36" FP2	RS A225
90x90 cm 36"x36" DECORO FP2	RS A226



grigio

90x90 cm 36"x36" FP2	RS A225
90x90 cm 36"x36" DECORO FP2	RS A226
61,0x61,0 cm 24"x24" FP2	RS A198
61,0x61,0 cm 24"x24" DECORO FP2	RS A199



mix

90x90 cm 36"x36" FP2	RS A225
90x90 cm 36"x36" DECORO FP2	RS A226
61,0x61,0 cm 24"x24" FP2	RS A198
61,0x61,0 cm 24"x24" DECORO FP2	RS A199

FP2 pezzi speciali - special pieces - pièces spéciales - formteile

<p>elemento "L"</p> <p>*45x90x5 cm 18"x36"x2" RS P101</p> <p>*30x61,0x5 cm 12"x24"x2" RS P100</p> <p>*/•beige</p> <p>*caffè</p> <p>*/•grigio</p> <p>*/•mix</p>	<p>angolare elemento "L"</p> <p>*45x90x5 cm 18"x36"x2" RS P104</p> <p>*30x30x5 cm 12"x12"x2" RS P103</p> <p>*/•beige</p> <p>*caffè</p> <p>*/•grigio</p> <p>*/•mix</p>	<p>griglia</p> <p>*20x90 cm 8"x36" RS P118</p> <p>*20x61,0 cm 8"x24" RS P117</p> <p>*/•beige</p> <p>*caffè</p> <p>*/•grigio</p> <p>*/•mix</p>	<p>griglia angolo</p> <p>*20x90 cm 8"x36" RS P108 COPPIA</p> <p>*20x61,0 cm 8"x24" RS P107 COPPIA</p> <p>angolo SX</p> <p>angolo DX</p> <p>*/•beige</p> <p>*caffè</p> <p>*/•grigio</p> <p>*/•mix</p>
<p>round lineare</p> <p>*45x90 cm 18"x36" RS P111</p> <p>*30x61,0 cm 12"x24" RS P110</p> <p>*/•beige</p> <p>*caffè</p> <p>*/•grigio</p> <p>*/•mix</p>	<p>round angolare</p> <p>*45x90 cm 18"x36" RS P120 COPPIA</p> <p>*30x61,0 cm 12"x24" RS P119 COPPIA</p> <p>angolo SX</p> <p>angolo DX</p> <p>*/•beige</p> <p>*caffè</p> <p>*/•grigio</p> <p>*/•mix</p>	<p>angolo bordo toro</p> <p>*45x90 cm 18"x36" RS P115</p> <p>*30x61,0 cm 12"x24" RS P114</p> <p>angolo SX</p> <p>angolo DX</p> <p>*/•beige</p> <p>*caffè</p> <p>*/•grigio</p> <p>*/•mix</p>	

Note - Notes - Notes - Anmerkungen
I pezzi speciali FP2 vengono venduti al pezzo e solo su ordinazione (tempo minimo di consegna 20 gg lavorativi dall'ordine)
The special pieces FP2 are sold by piece and only on request (minimum delivery time 20 working days from date of order).
Les pièces spéciales FP2 sont vendus à la pièce et uniquement sur commande (délai minimum de livraison 20 jours ouvrés à partir de la commande).
Spezial Teile FP2 sind pro Stück verkauft und nur auf Bestellungen produziert. (Lieferzeiten mindesten 20 arbeitstage ab Auftragbestätigung)

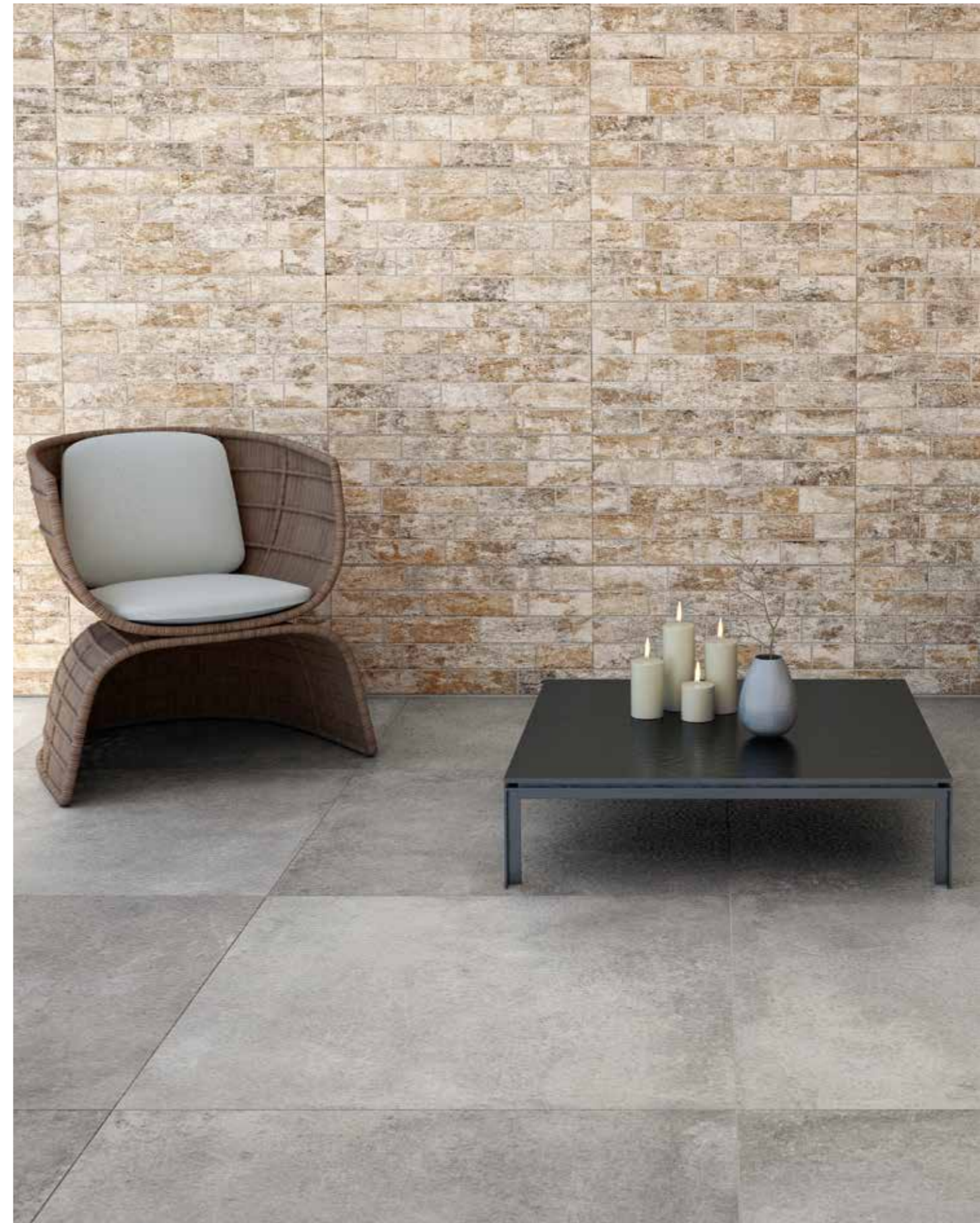

FP2 Grigio
90x90 cm . 36"x36" RS











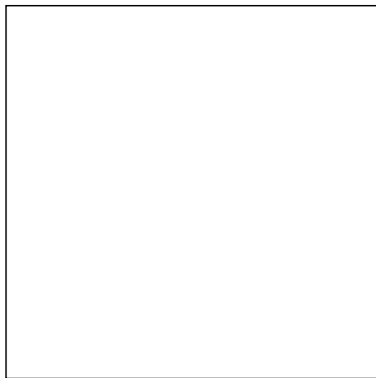

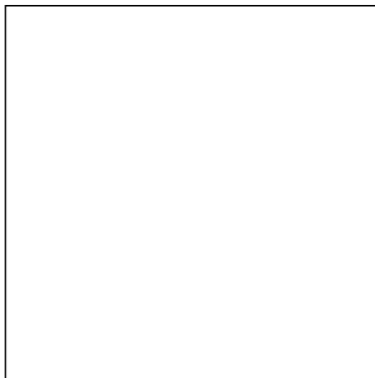

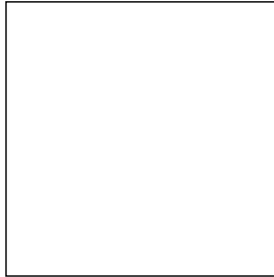
MY S'TILE

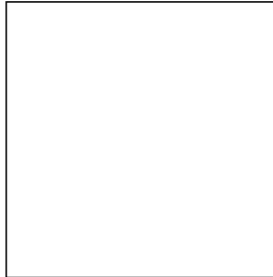
grès porcellanato impasto colorato
color body porcelain stoneware . grès cérame coloré dans la masse . durchgefärbtes feinsteinzeug

effetto cemento
concrete-look
effet ciment
zementoptik

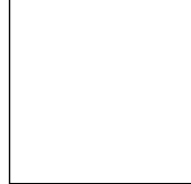

Formati Sizes - Formats - Formate

 <p>R10  tutti i colori / all colors</p> <p>122,6x122,6 cm R / 48"x48" R</p>	<p>FP2</p>  <p>R11 FP2  my grey</p> <p>FP2 122x122 cm RS / 48"x48" RS</p>
 <p>R10  tutti i colori / all colors</p> <p>90x90 cm R / 36"x36" R</p> <p>R11 outdoor  my sand, my grey</p> <p>90x90 cm R - outdoor / 36"x36" R - outdoor</p>	 <p>R11 FP2  my sand, my camel, my grey</p> <p>FP2 90x90 cm RS / 36"x36" RS</p>
 <p>R10  tutti i colori / all colors</p> <p>61,3x122,6 cm R / 24"x48" R</p>	
 <p>R10  tutti i colori /all colors</p> <p>61,0x61,0 cm R / 24"x24" R</p> <p>R11 outdoor  my sand, my grey</p> <p>61,0x61,0 cm R - outdoor / 24"x24" R - outdoor</p>	 <p>R10  tutti i colori / all colors</p> <p>30,4x61,0 cm R / 12"x24" R</p>

Colori Colours - Couleurs - Farbe



My Grey
122,6x122,6 cm . 48"x48" R

MY S'TILE



my sand

122,6x122,6 cm 48"x48"	R	A230
90x90 cm 36"x36"	R	A220
90x90 cm 36"x36" OUTDOOR	R	A224
61,3x122,6 cm 24"x48"	R	A180
61,0x61,0 cm 24"x24"	R	A192
61,0x61,0 cm 24"x24" OUTDOOR	R	A193
30,4x61,0 cm 12"x24"	R	A110

FP2

90x90 cm 36"x36" FP2	RS	A225
----------------------	----	------



my white

122,6x122,6 cm 48"x48"	R	A230
90x90 cm 36"x36"	R	A220
61,3x122,6 cm 24"x48"	R	A180
61,0x61,0 cm 24"x24"	R	A192
30,4x61,0 cm 12"x24"	R	A110



my camel

122,6x122,6 cm 48"x48"	R	A230
90x90 cm 36"x36"	R	A220
61,3x122,6 cm 24"x48"	R	A180
61,0x61,0 cm 24"x24"	R	A192
30,4x61,0 cm 12"x24"	R	A110

FP2

90x90 cm 36"x36" FP2	RS	A225
----------------------	----	------



my grey

122,6x122,6 cm 48"x48"	R	A230
90x90 cm 36"x36"	R	A220
90x90 cm 36"x36" OUTDOOR	R	A224
61,3x122,6 cm 24"x48"	R	A180
61,0x61,0 cm 24"x24"	R	A192
61,0x61,0 cm 24"x24" OUTDOOR	R	A193
30,4x61,0 cm 12"x24"	R	A110

FP2

122x122 cm 48"x48" FP2	RS	A232
90x90 cm 36"x36" FP2	RS	A225

MY S'TILE

decori - decors - décors - dekors

mosaico monocolor 81 tessere 3x3 - 30x30 cm 12"x12" 7 **P73**

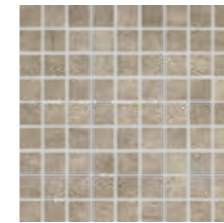

my camel



my sand



my grey



my white

mosaico asimmetrico 18 pz - 30x30 cm 12"x12" 9 **P77**



my camel

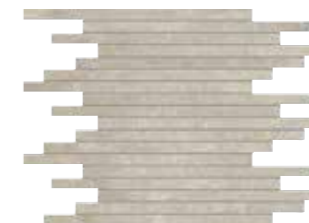

my sand

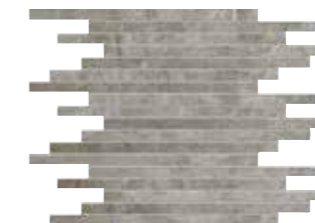

my grey



my white

pezzi speciali - special pieces - pièces spéciales - formteile

elemento "L" monolitico outdoor **P51** 2
15x61x4 cm 6"x24"x1 3/4"



my sand

my grey

battiscopa **P05** 10
6,5x122,6 cm 2 1/2"x48"



my camel

my sand

my grey

my white

step **P90**
30,4x61,0 cm 12"x24"

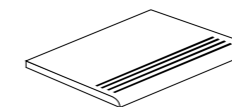

my camel

my sand

my white

my grey

gradino costa retta **P32** **P31**
34x122,6x4 cm 13"x48"x1 3/4"
34x61,0x4 cm 13"x24"x1 3/4"



my camel

my sand

my white

my grey

angolare costa retta dx/sx **P41** **P40**
34x122,6x4 cm 13"x48"x1 3/4"
34x34x4 cm 13"x13"x1 3/4"

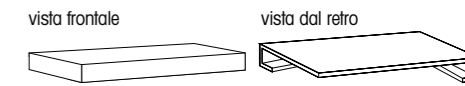

my camel

my sand

my white

my grey

Note - Notes - Notes - Anmerkungen

I battiscopa e gli elementi "L" vengono venduti a pz. e a scatola completa. Tutti gli altri pezzi speciali vengono venduti al pezzo. I gradini vengono prodotti solo su ordinazione (tempo minimo di consegna 20 gg lavorativi).
All skirting and monolithic L elements, priced per piece, are sold in full box. All other special trims are sold by piece. Steps are produced only on request (minimum delivery terms of 20 days).
Les plinthes et élément "L" sont vendues la pièce et par boîte complète. Les autres pièces spéciales sont vendus la pièce. Le plat de marche sont produit sur demande (délai minimum de 20 jours).
Die Sockelleisten und Stufen werden pro Stk. und Vollen Kartons verkauft. Stufen und Stufenecken werden nur auf Bestellung produziert (Lieferzeiten mindesten 20 arbeitstagen ab Auftragserteilung).

MY S'TILE **FP2**

technical project
FP2
outdoor



my grey

122x122 cm 48"x48" **FP2**

90x90 cm 36"x36" **FP2**



RS **A232**

RS **A225**



my sand

90x90 cm 36"x36" **FP2**



RS **A225**



my camel

90x90 cm 36"x36" **FP2**



RS **A225**

FP2 pezzi speciali - special pieces - pièces spéciales - formteile

elemento "L"

•45x90x5 cm 18"x36"x2" **RS P101**
•40x122x5 cm 16"x48"x2" **RS P102**

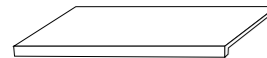

•my sand
•my camel
•/*my grey

angolare elemento "L"

•45x90x5 cm 18"x36"x2" **RS P104**
•40x122x5 cm 16"x48"x2" **RS P105**



•my sand
•my camel
•/*my grey

griglia

•20x90 cm 8"x36" **RS P118**
•20x61,0 cm 8"x24" **RS P106**

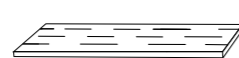

•my sand
•my camel
•/*my grey

* Griglia e griglia angolo 20x61 cm abbinata al formato 40x122 cm.
Grille and corner grille 8"x24" combined with the 16"x48" size.

griglia angolo

•20x90 cm 8"x36" **RS P108 COPPIA**
•20x61,0 cm 8"x24" **RS P109 COPPIA**

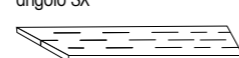

•my sand
•my camel
•/*my grey

angolo SX

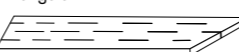

•my sand
•my camel
•/*my grey

angolo DX

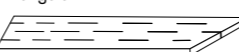

•my sand
•my camel
•/*my grey

round lineare

•45x90 cm 18"x36" **RS P111**
•40x122 cm 16"x48" **RS P112**

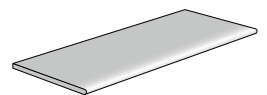

•my sand
•my camel
•/*my grey

round angolare

•45x90 cm 18"x36" **RS P120 COPPIA**
•40x122 cm 16"x48" **RS P113 COPPIA**

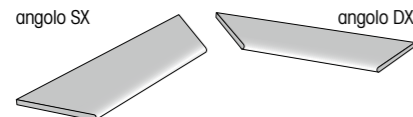

•my sand
•my camel
•/*my grey

angolo bordo toro

•45x90 cm 18"x36" **RS P115**
•40x122 cm 16"x48" **RS P116**

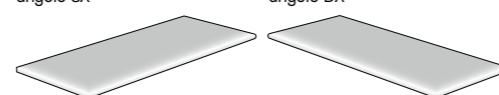

•my sand
•my camel
•/*my grey

Note - Notes - Notes - Anmerkungen

I pezzi speciali FP2 vengono venduti al pezzo e solo su ordinazione (tempo minimo di consegna 20 gg lavorativi dall'ordine)

The special pieces FP2 are sold by piece and only on request (minimum delivery time 20 working days from date of order).

Les pièces spéciales FP2 sont vendus à la pièce et uniquement sur commande (délai minimum de livraison 20 jours ouvrés à partir de la commande).

Spezial Teile FP2 sind pro Stück verkauft und nur auf Bestellungen produziert. (Lieferzeiten mindesten 20 arbeitstage ab Auftragbestätigung)



FP2 Sand
90x90 cm . 36"x36" RS - elemento a L 45x90x5 cm . 18"x36"x2"

GREY SOUL

effetto cemento
concrete-look
effet ciment
zementoptik

grès porcellanato impasto colorato
color body porcelain stoneware . grès cérame coloré dans la masse . durchgefärbtes feinsteinzeug



Formati Sizes - Formats - Formate

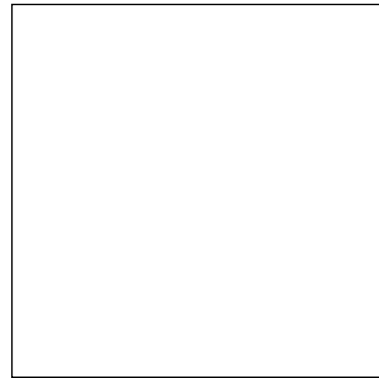

122,6x122,6 cm R / 48"x48" R



tutti i colori / all colors

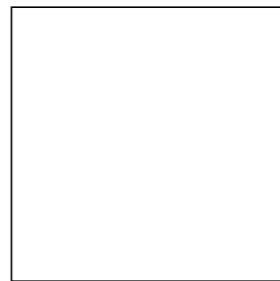

90x90 cm R / 36"x36" R
90x90 cm R - outdoor / 36"x36" R - outdoor



tutti i colori / all colors



mid, dark



61,3x122,6 cm R / 24"x48" R



sand, light, mid, dark

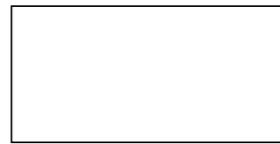

45x90 cm R / 18"x36" R



light, mid, dark

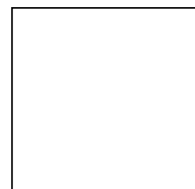

61,5x61,5 cm N / 24"x24" N
61,5x61,5 cm N - outdoor / 24"x24" N - outdoor
61,0x61,0 cm R / 24"x24" R



tutti i colori / all colors



sand, mid, dark

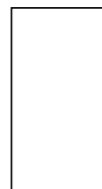

30,8x61,5 cm N / 12"x24" N
30,8x61,5 cm N - outdoor / 12"x24" N - outdoor
30,4x61,0 cm R / 12"x24" R



tutti i colori / all colors



sand, mid, dark

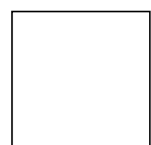

45,5x45,5 cm N / 18"x18" N
45,5x45,5 cm N - outdoor / 18"x18" N - outdoor



mid, dark



mid, dark

Colori Colours - Couleurs - Farbe



WHITE



SAND



LIGHT



MID



DARK

Formati Sizes - Formats - Formate **FP2**

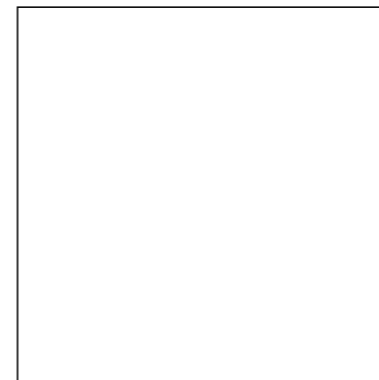

FP2 122x122 cm RS / 48"x48" RS



mid, dark

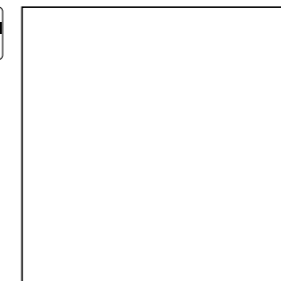

FP2 90x90 cm RS / 36"x36" RS



sand, light, mid, dark

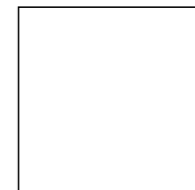

FP2 61,0x61,0 cm RS / 24"x24" RS



sand, light, mid, dark

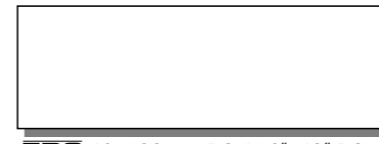

FP2 40x122 cm RS / 16"x48" RS



light, mid, dark

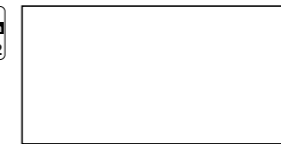

FP2 45x90 cm RS / 18"x36" RS



sand, light, mid, dark



R RETTIFICATO RECTIFIED **RS** RETTIFICATO/STRUTTURATO RECTIFIED/TEXTURED **N** NATURALE NATURAL

Light
61,3x122,6 cm . 24"x48" R

GREY SOUL



sand

122,6x122,6 cm 48"x48"	R	A230
90x90 cm 36"x36"	R	A220
61,3x122,6 cm 24"x48"	R	A180
61,5x61,5 cm 24"x24"	N	A190
61,5x61,5 cm 24"x24" OUTDOOR	N	A191
61,0x61,0 cm 24"x24"	R	A192
30,8x61,5 cm 12"x24"	N	A140
30,8x61,5 cm 12"x24" OUTDOOR	N	A141
30,4x61,0 cm 12"x24"	R	A110

FP2

90x90 cm 36"x36" FP2	RS	A225
61,0x61,0 cm 24"x24" FP2	RS	A198
45x90 cm 18"x36" FP2	RS	A171



white

122,6x122,6 cm 48"x48"	R	A230
90x90 cm 36"x36"	R	A220
61,5x61,5 cm 24"x24"	N	A190
61,0x61,0 cm 24"x24"	R	A192
30,8x61,5 cm 12"x24"	N	A140
30,4x61,0 cm 12"x24"	R	A110



light

122,6x122,6 cm 48"x48"	R	A230
90x90 cm 36"x36"	R	A220
61,3x122,6 cm 24"x48"	R	A180
61,5x61,5 cm 24"x24"	N	A190
61,0x61,0 cm 24"x24"	R	A192
45x90 cm 18"x36"	R	A170
30,8x61,5 cm 12"x24"	N	A140
30,4x61,0 cm 12"x24"	R	A110

FP2

90x90 cm 36"x36" FP2	RS	A225
61,0x61,0 cm 24"x24" FP2	RS	A198
45x90 cm 18"x36" FP2	RS	A171
40x122 cm 16"x48" FP2	RS	A150



mid

122,6x122,6 cm 48"x48"	R	A230
90x90 cm 36"x36"	R	A220
90x90 cm 36"x36" OUTDOOR	R	A224
61,3x122,6 cm 24"x48"	R	A180
61,5x61,5 cm 24"x24"	N	A190
61,5x61,5 cm 24"x24" OUTDOOR	N	A191
61,0x61,0 cm 24"x24"	R	A192
45,5x45,5 cm 18"x18"	N	A160
45,5x45,5 cm 18"x18" OUTDOOR	N	A161
45x90 cm 18"x36"	R	A170
30,8x61,5 cm 12"x24"	N	A140
30,8x61,5 cm 12"x24" OUTDOOR	N	A141
30,4x61,0 cm 12"x24"	R	A110

FP2

122x122 cm 48"x48" FP2	RS	A232
90x90 cm 36"x36" FP2	RS	A225
61,0x61,0 cm 24"x24" FP2	RS	A198
45x90 cm 18"x36" FP2	RS	A171
40x122 cm 16"x48" FP2	RS	A150



dark

122,6x122,6 cm 48"x48"	R	A230
90x90 cm 36"x36"	R	A220
90x90 cm 36"x36" OUTDOOR	R	A224
61,3x122,6 cm 24"x48"	R	A180
61,5x61,5 cm 24"x24"	N	A190
61,5x61,5 cm 24"x24" OUTDOOR	N	A191
61,0x61,0 cm 24"x24"	R	A192
45,5x45,5 cm 18"x18"	N	A160
45,5x45,5 cm 18"x18" OUTDOOR	N	A161
45x90 cm 18"x36"	R	A170
30,8x61,5 cm 12"x24"	N	A140
30,8x61,5 cm 12"x24" OUTDOOR	N	A141
30,4x61,0 cm 12"x24"	R	A110

FP2

122x122 cm 48"x48" FP2	RS	A232
90x90 cm 36"x36" FP2	RS	A225
61,0x61,0 cm 24"x24" FP2	RS	A198
45x90 cm 18"x36" FP2	RS	A171
40x122 cm 16"x48" FP2	RS	A150

GREY SOUL

decori - decors - décors - dekors

mosaico monocolor 36 tessere 5x5 - 30x30 cm 12"x12"  7 **P71**



sand white light mid dark

mosaico mix 81 tessere 3x3 - 30x30 cm 12"x12"  7 **P73**

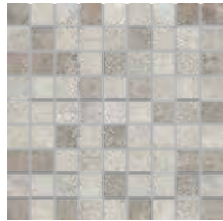

light / mid / dark

listello patchwork - 30,2x61 cm 12"x24"  4 **P83**



sand



light



dark



white



mid

GREY SOUL

Mid 30,8x61,5 cm . 12"x24" N outdoor
elemento "L" monolitico outdoor 15x61x4 cm . 6"x24"x1^{3/4}"



pezzi speciali - special pieces - pièces spéciales - formteile

elemento "L" monolitico outdoor **P51**  2
15x61x4 cm 6"x24"x1^{3/4}"



sand mid dark

battiscopa
6,5x61,5 cm 2^{1/2}"x24" **N** **P10**  12

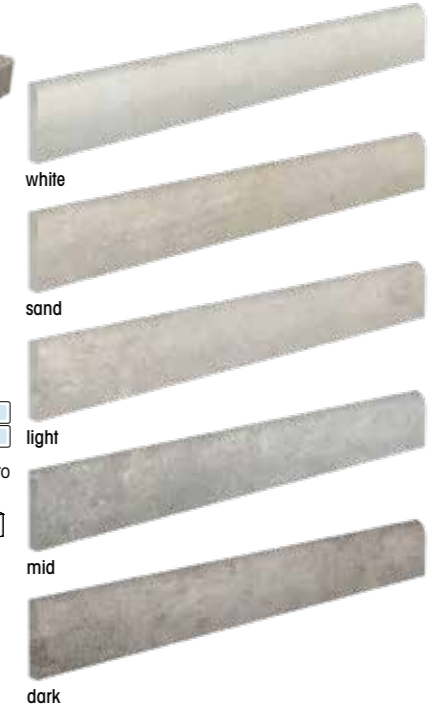

white
sand
light
mid
dark

step
30,8x61,5 cm 12"x24" **N** **P92**

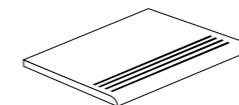

white
sand
light
mid
dark

gradino costa retta
34x122,6x4 cm 13"x48"x1^{3/4}" **R** **P32**
34x61,5x4 cm 13"x24"x1^{3/4}" **N** **P31**

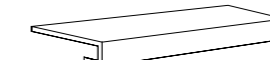

white
sand
light
mid
dark

angolare costa retta dx/sx
34x122,6x4 cm 13"x48"x1^{3/4}" **R** **P41**
34x34x4 cm 13"x13"x1^{3/4}" **N** **P40**

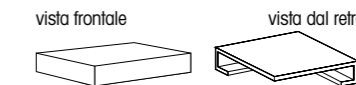

white
sand
light
mid
dark

Note - Notes - Notes - Anmerkungen
I battiscopa e gli elementi "L" vengono venduti a pz. e a scatola completa. Tutti gli altri pezzi speciali vengono venduti al pezzo. I gradini vengono prodotti solo su ordinazione (tempo minimo di consegna 20 gg lavorativi).
All skirting and monolithic L elements, priced per piece, are sold in full box. All other special trims are sold by piece. Steps are produced only on request (minimum delivery terms of 20 days).
Les plinthes et élément "L" sont vendues la pièce et par boîte complète. Les autres pièces spéciales sont vendus la pièce. Le plat de marche sont produit sur demande (délai minimum de 20 jours).
Die Sockelleisten und Stufen werden pro Stk. und Vollen Kartons verkauft. Stufen und Stufenecken werden nur auf Bestellung produziert (Lieferzeiten mindesten 20 arbeitstagen ab Auftragserteilung).

GREY SOUL **FP2**

technical project
FP2
outdoor



sand

90x90 cm 36"x36" FP2	RS A225
61,0x61,0 cm 24"x24" FP2	RS A198
45x90 cm 18"x36" FP2	RS A171



mid

122x122 cm 48"x48" FP2	RS A232
90x90 cm 36"x36" FP2	RS A225
61,0x61,0 cm 24"x24" FP2	RS A198
45x90 cm 18"x36" FP2	RS A171
40x122 cm 16"x48" FP2	RS A150



light

90x90 cm 36"x36" FP2	RS A225
61,0x61,0 cm 24"x24" FP2	RS A198
45x90 cm 18"x36" FP2	RS A171
40x122 cm 16"x48" FP2	RS A150



dark

122x122 cm 48"x48" FP2	RS A232
90x90 cm 36"x36" FP2	RS A225
61,0x61,0 cm 24"x24" FP2	RS A198
45x90 cm 18"x36" FP2	RS A171
40x122 cm 16"x48" FP2	RS A150

FP2 pezzi speciali - special pieces - pièces spéciales - formteile

* Griglia e griglia angolo 20x61 cm abbinare ai formati 122x122 cm e 40x122 cm.
Grille and corner grille 8"x24" combined with the 48"x48" and 16"x48" size.

elemento "L"
*45x90x5 cm 18"x36"x2" **RS P101**
*30x61,0x5 cm 12"x24"x2" **RS P100**
*40x122x5 cm 16"x48"x2" **RS P102**

angolare elemento "L"
*45x90x5 cm 18"x36"x2" **RS P104**
*30x30x5 cm 12"x12"x2" **RS P103**
*40x122x5 cm 16"x48"x2" **RS P105**

griglia
*20x90 cm 8"x36" **RS P118**
*20x61,0 cm 8"x24" **RS P117**
*20x61,0 cm 8"x24" **RS P106**

griglia angolo
*20x90 cm 8"x36" **RS P108 COPPIA**
*20x61,0 cm 8"x24" **RS P107 COPPIA**
*20x61,0 cm 8"x24" **RS P109 COPPIA**



* / • sand
* / • / ♦ light
* / • / ♦ mid
* / • / ♦ dark

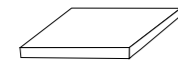

* / • sand
* / • / ♦ light
* / • / ♦ mid
* / • / ♦ dark

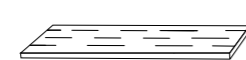

* / • sand
* / • / ♦ light
* / • / ♦ mid
* / • / ♦ dark

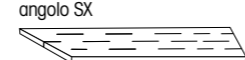

* / • sand
* / • / ♦ light
* / • / ♦ mid
* / • / ♦ dark

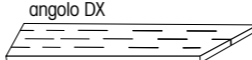

round lineare
*45x90 cm 18"x36" **RS P111**
*30x61,0 cm 12"x24" **RS P110**
*40x122 cm 16"x48" **RS P112**

round angolare
*45x90 cm 18"x36" **RS P120 COPPIA**
*30x61,0 cm 12"x24" **RS P119 COPPIA**
*40x122 cm 16"x48" **RS P113 COPPIA**

angolo SX
angolo DX

angolo bordo toro
*45x90 cm 18"x36" **RS P115**
*30x61,0 cm 12"x24" **RS P114**
*40x122 cm 16"x48" **RS P116**

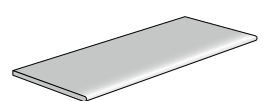

* / • sand
* / • / ♦ light
* / • / ♦ mid
* / • / ♦ dark

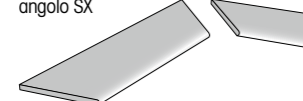

* / • sand
* / • / ♦ light
* / • / ♦ mid
* / • / ♦ dark

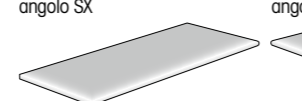
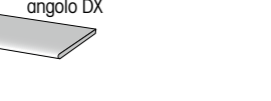

* / • sand
* / • / ♦ light
* / • / ♦ mid
* / • / ♦ dark

Note - Notes - Notes - Anmerkungen

I pezzi speciali FP2 vengono venduti al pezzo e solo su ordinazione (tempo minimo di consegna 20 gg lavorativi dall'ordine)

The special pieces FP2 are sold by piece and only on request (minimum delivery time 20 working days from date of order).

Les pièces spéciales FP2 sont vendus à la pièce et uniquement sur commande (délai minimum de livraison 20 jours ouvrés à partir de la commande).

Spezial Teile FP2 sind pro Stück verkauft und nur auf Bestellungen produziert. (Lieferzeiten mindesten 20 arbeitstage ab Auftragbestätigung)

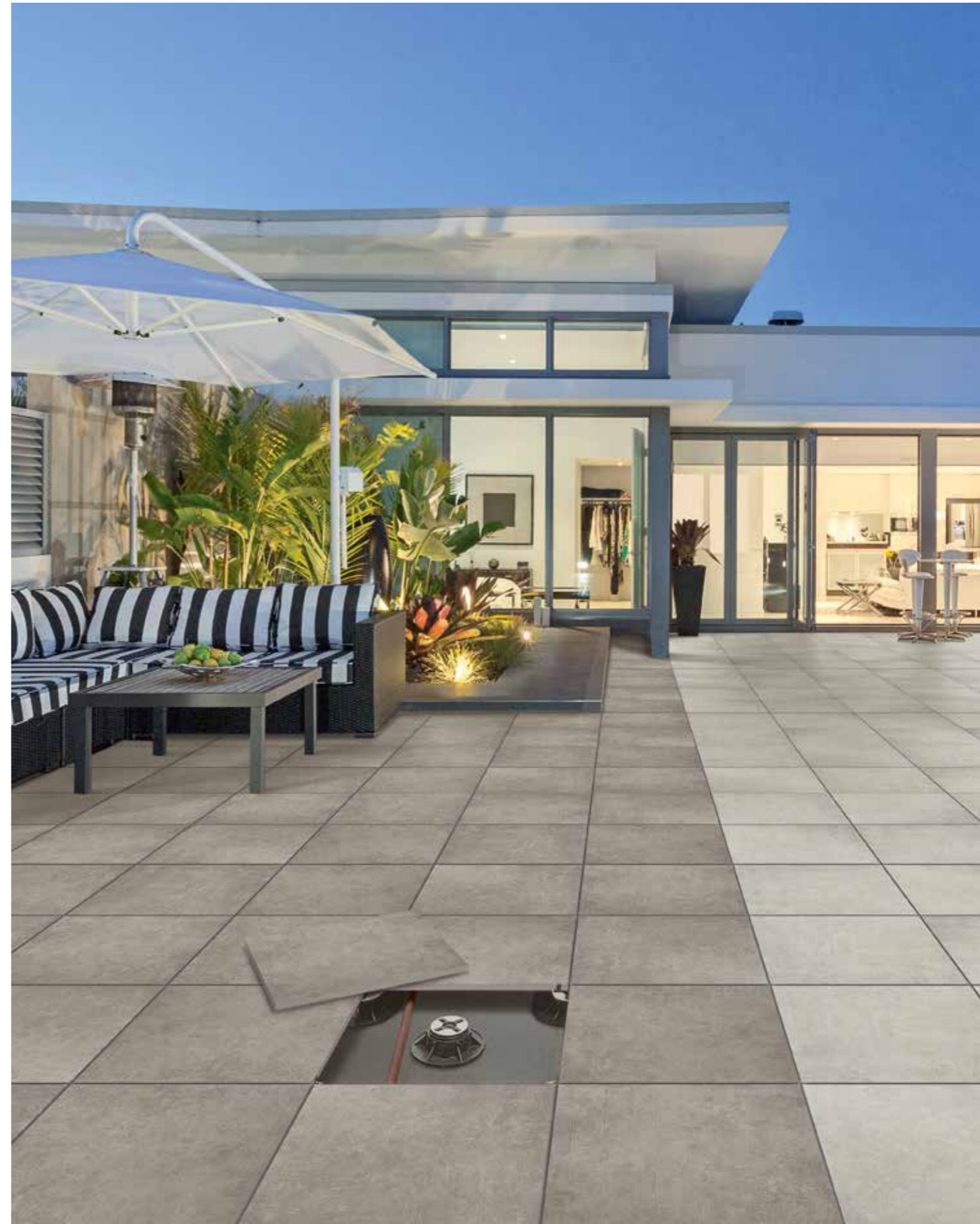

FP2 Dark e Light
61,0x61,0 cm . 24"x24" RS

LEVEL

effetto cemento
concrete-look
effet ciment
zementoptik

grès porcellanato impasto colorato
color body porcelain stoneware . grès cérame coloré dans la masse . durchgefärbtes feinsteinzeug



Formati
Sizes - Formats - Formate

90x90 cm R / 36"x36" R

61,3x122,6 cm R / 24"x48" R
61,3x122,6 cm R / 24"x48" R - DECORO

61,0x61,0 cm R / 24"x24" R

30,4x61,0 cm R / 12"x24" R

N NATURALE NATURAL **R** RETTIFICATO RECTIFIED

Colori
Colours - Couleurs - Farbe

WHITE

GREY

DARK GREY

ANTHRACITE

rivestimento coordinato - matching wall tiles - faïences coordonnées - koordinierte wandfliesen:
Level 20x50 cm . 8"x20"

bicottura tradizionale
traditional double fired - traditionnelle double feue - zweibrandfliesen

Formati
Sizes - Formats - Formate

20x50 cm / 8"x20" N

Colori
Colours - Couleurs - Farbe

WHITE

GREY

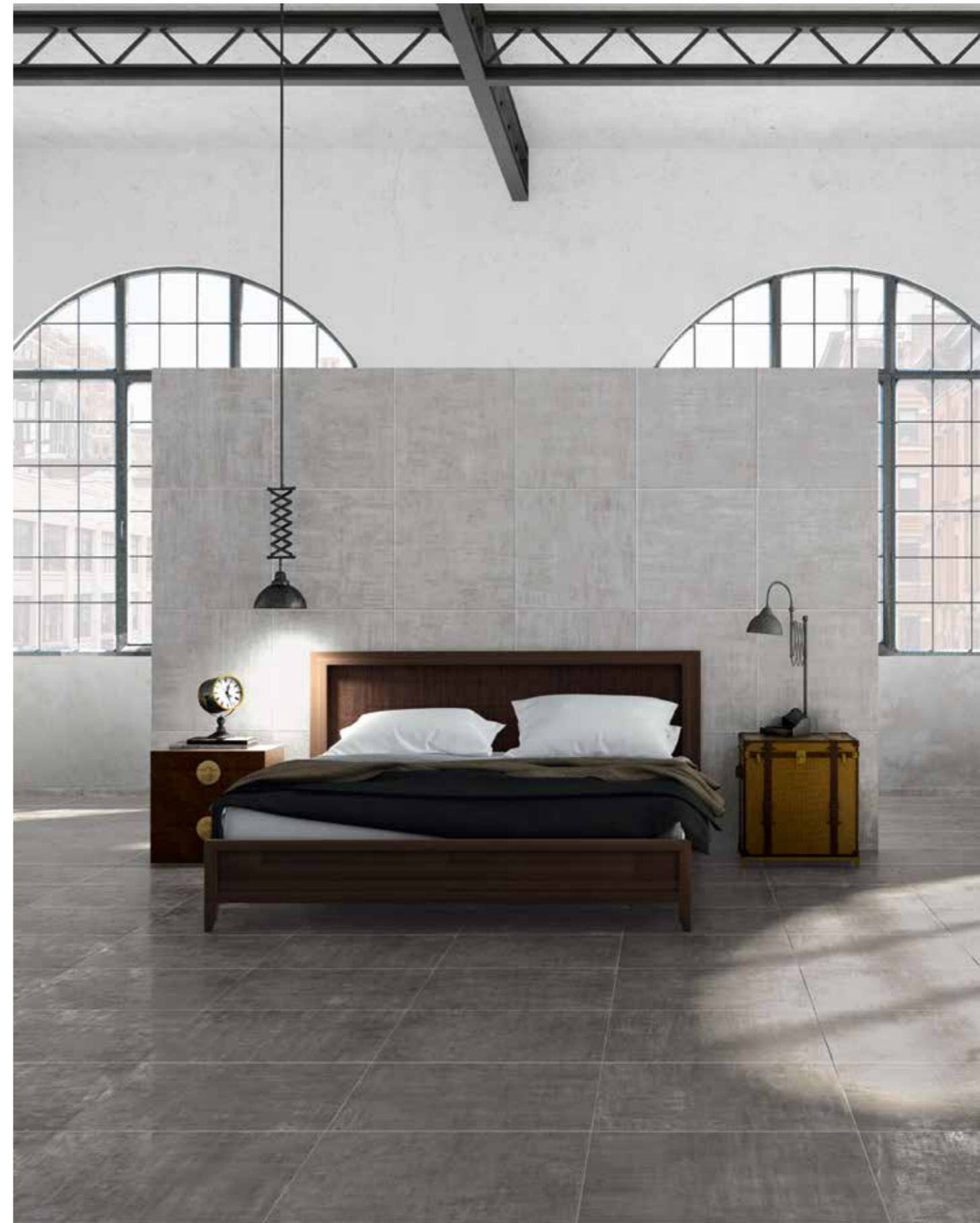

floor: Anthracite 61,0x61,0 cm . 24"x24" R
wall: Grey 61,0x61,0 cm . 24"x24" R

LEVEL

white

90x90 cm 36"x36"	R A220
61,3x122,6 cm 24"x48"	R A180
61,3x122,6 cm 24"x48" DECORO	R A181
61,0x61,0 cm 24"x24"	R A192
30,4x61,0 cm 12"x24"	R A110



dark grey

90x90 cm 36"x36"	R A220
61,3x122,6 cm 24"x48"	R A180
61,3x122,6 cm 24"x48" DECORO	R A181
61,0x61,0 cm 24"x24"	R A192
30,4x61,0 cm 12"x24"	R A110



grey

90x90 cm 36"x36"	R A220
61,3x122,6 cm 24"x48"	R A180
61,3x122,6 cm 24"x48" DECORO	R A181
61,0x61,0 cm 24"x24"	R A192
30,4x61,0 cm 12"x24"	R A110



anthracite

90x90 cm 36"x36"	R A220
61,3x122,6 cm 24"x48"	R A180
61,3x122,6 cm 24"x48" DECORO	R A181
61,0x61,0 cm 24"x24"	R A192
30,4x61,0 cm 12"x24"	R A110

LEVEL

decori - decors - décors - dekors

decoro - 61,3x122,6 cm 24"x48" R



white 61,3x122,6 cm 24"x48"

R A181

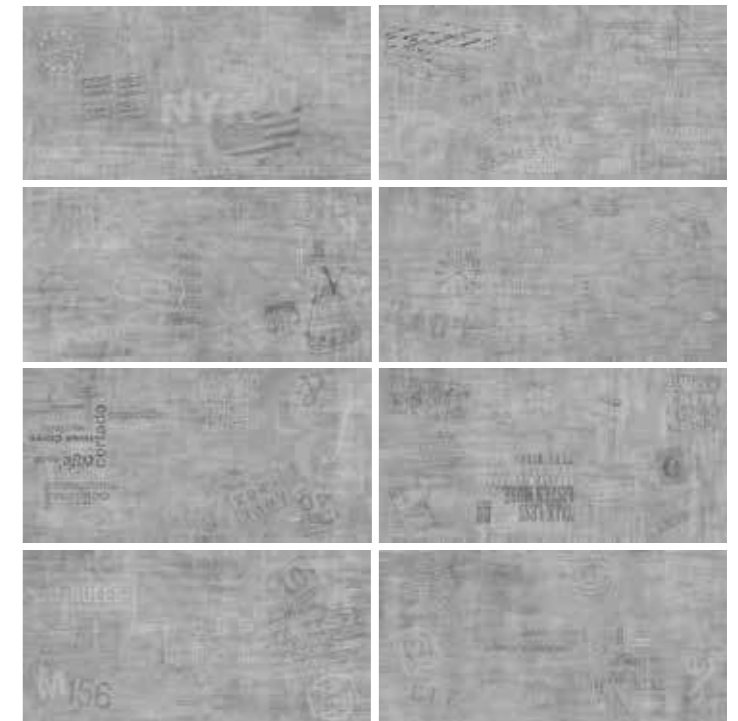

grey 61,3x122,6 cm 24"x48"

R A181

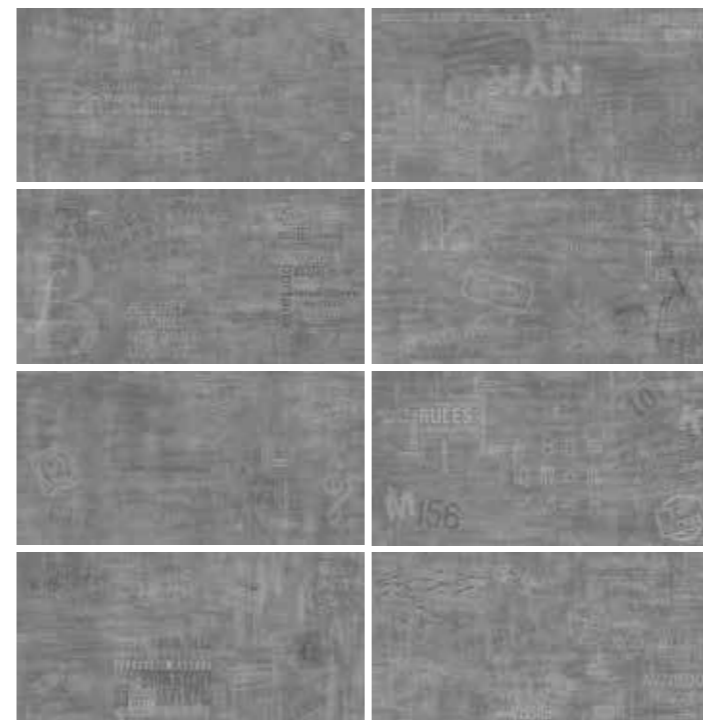

dark grey 61,3x122,6 cm 24"x48"

R A181

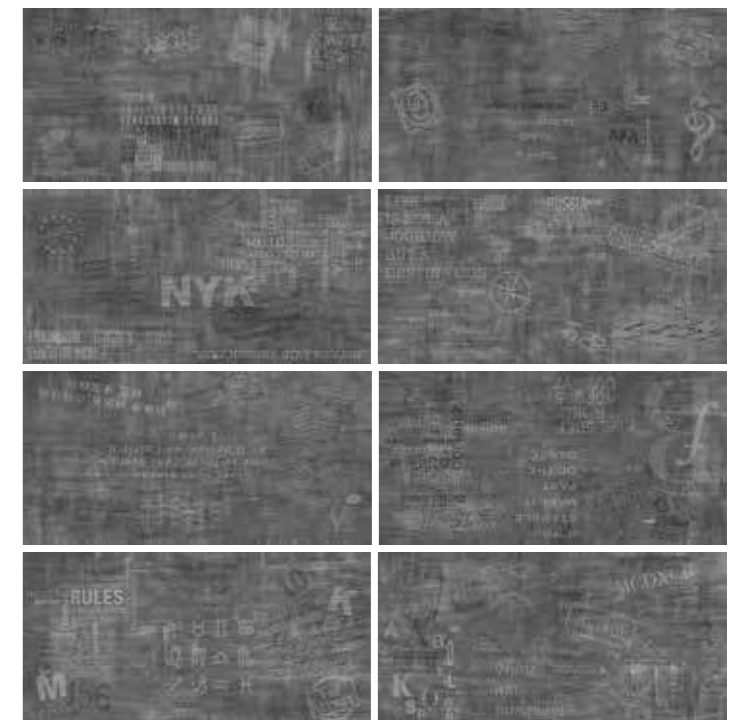

anthracite 61,3x122,6 cm 24"x48"

R A181

LEVEL

LEVEL wall

decori - decors - décors - dekors

mosaico monocolor 36 tessere 5x5 - 30x30 cm 12"x12"  7 **P71**



white



grey



dark grey

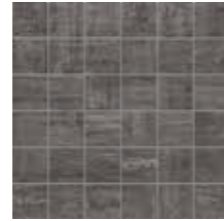

anthracite

mosaico monocolor 81 tessere 3x3 - 30x30 cm 12"x12"  7 **P73**



white



grey

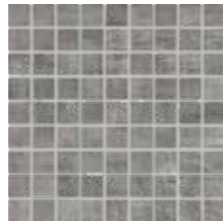

dark grey

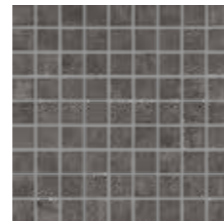

anthracite

mosaico asimmetrico 18 pz - 30x30 cm 12"x12"  9 **P77**



white



grey



dark grey



anthracite

pezzi speciali - special pieces - pièces spéciales - formteile

battiscopa
6,5x61,0 cm 2 1/2"x24" **R P07**  12



white



grey



dark grey



anthracite

step
30,4x61,0 cm 12"x24" **R P90**

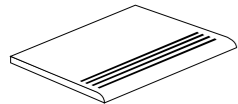

white

grey

dark grey

anthracite

gradino costa retta
34x122,6x4 cm 13"x48"x1 3/4"
34x61,0x4 cm 13"x24"x1 3/4" **R P32**
R P31

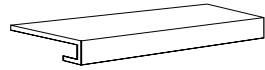

white

grey

dark grey

anthracite

angolare costa retta dx/sx
34x122,6x4 cm 13"x48"x1 3/4"
34x34x4 cm 13"x13"x1 3/4" **R P41**
R P40

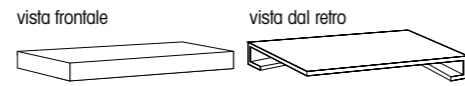

white

grey

dark grey

anthracite

Note - Notes - Notes - Anmerkungen
I battiscopa vengono venduti a pz. e a scatola completa. Tutti gli altri pezzi speciali vengono venduti al pezzo. I gradini vengono prodotti solo su ordinazione (tempo minimo di consegna 20 gg lavorativi).
All skirting priced per piece, are sold in full box. All other special trims are sold by piece. Steps are produced only on request (minimum delivery terms of 20 days).
Les plinthes sont vendues la pièce et par boîte complète. Les autres pièces spéciales sont vendus la pièce. Le plat de marche sont produit sur demande (délai minimum de 20 jours).
Die Sockelleisten werden pro Stk. und Vollen Kartons verkauft. Stufen und Stufenecken werden nur auf Bestellung produziert (Lieferzeiten mindesten 20 arbeitstagen ab Auftragserteilung).

bicottura tradizionale
traditional double fired - traditionnelle double feue - zweibrandfliesen
rivestimento coordinato - matching wall tiles - faïences coordonnées - koordinierte wandfliesen



white

20x50 cm 8"x20"

N A60





grey

20x50 cm 8"x20"

N A60

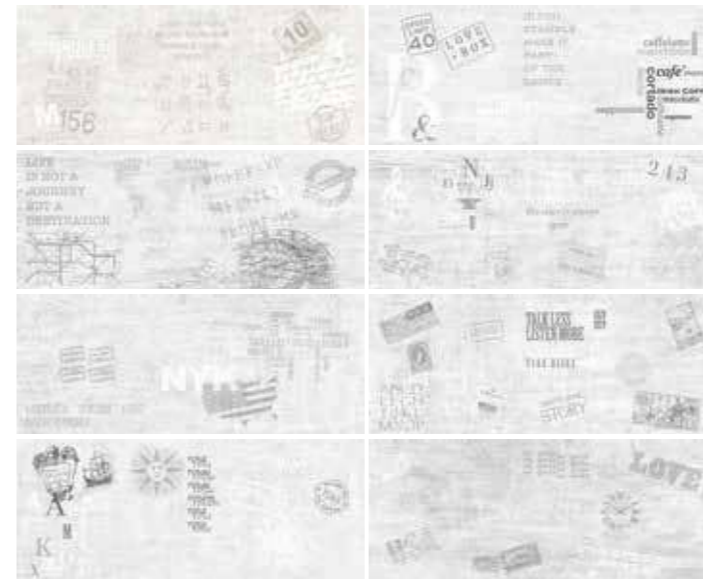
decori - decors - décors - dekors



decoro white 20x50 cm 8"x20" 

N A61

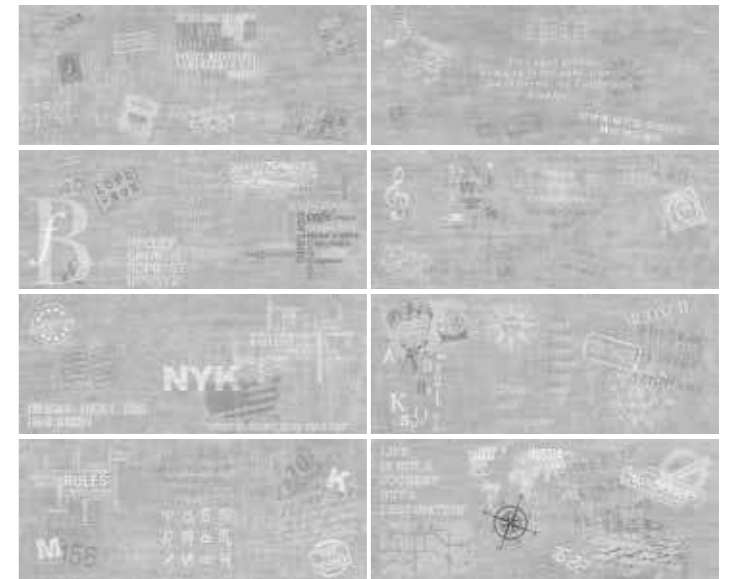

decoro grey 20x50 cm 8"x20" 

N A61

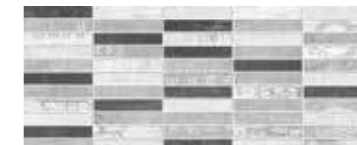

mosaico level

20x50 cm 8"x20" 

N A61

FRÜHLING DEKORE

effetto pietra
stone-look
effet pierre
steinoptik

grès porcellanato
porcelain stoneware . grès cérame . feinsteinzeug

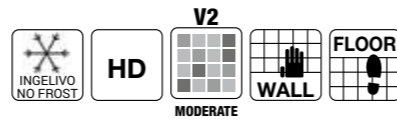

Formati
Sizes - Formats - Formate

Colori
Colours - Couleurs - Farbe

R9
tutti i colori / all colors
20x20 cm N / 8"x8" N

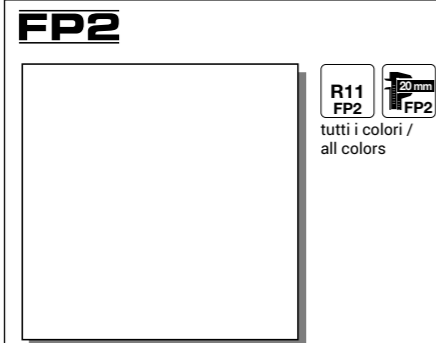

R11 FP2
tutti i colori / all colors

FP2 90x90 cm RS /
36"x36" RS

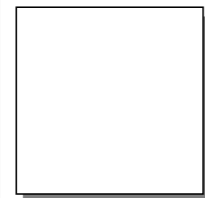

R11 FP2
tutti i colori / all colors

FP2 61,0x61,0 cm RS /
24"x24" RS

N NATURALE
NATURAL

RS RETTIFICATO/STRUTTURATO
RECTIFIED/TEXTURED



ARABISCH



LILIE



GEOMETRISCH



BLUMEN



Frühling Dekore Arabisch
20x20 cm . 8"x8" N

Frühling Dekore Lilie
20x20 cm . 8"x8" N



Frühling Dekore Geometrisch
20x20 cm . 8"x8" N

FRÜHLING DEKORE



monofaccia arabisch

20x20 cm 8"x8"

N A45

FP2

90x90 cm 36"x36" **FP2**

RS B226

61,0x61,0 cm 24"x24" **FP2**

RS B199

8 soggetti diversi, miscelazione casuale. 8 assorted motifs, random mix.
8 sujets differents, melange aleatoire. 8 verschiedene Motive, Zufallsmischung.



monofaccia lillie

20x20 cm 8"x8"

N A45

FP2

90x90 cm 36"x36" **FP2**

RS B226

61,0x61,0 cm 24"x24" **FP2**

RS B199

8 soggetti diversi, miscelazione casuale. 8 assorted motifs, random mix.
8 sujets differents, melange aleatoire. 8 verschiedene Motive, Zufallsmischung.



monofaccia geometricisch

20x20 cm 8"x8"

N A45

FP2

90x90 cm 36"x36" **FP2**

RS B226

61,0x61,0 cm 24"x24" **FP2**

RS B199

8 soggetti diversi, miscelazione casuale. 8 assorted motifs, random mix.
8 sujets differents, melange aleatoire. 8 verschiedene Motive, Zufallsmischung.

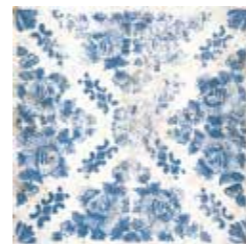
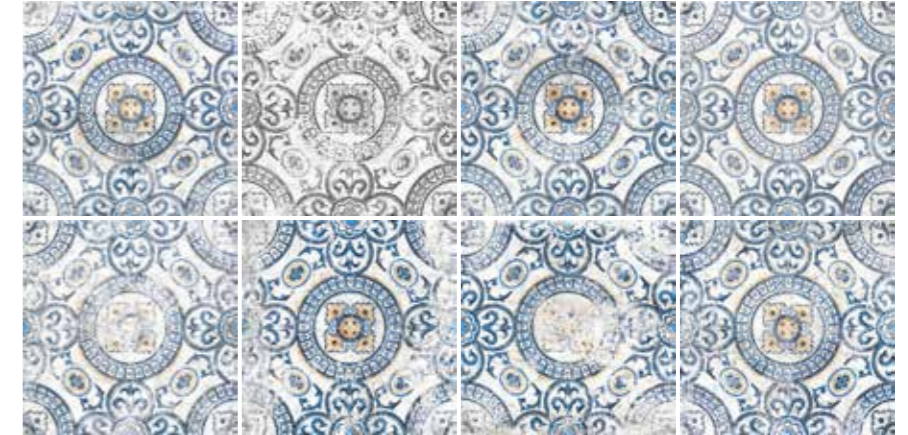

monofaccia blumen

20x20 cm 8"x8"

N A45

FP2

90x90 cm 36"x36" **FP2**

RS B226

61,0x61,0 cm 24"x24" **FP2**

RS B199

8 soggetti diversi, miscelazione casuale. 8 assorted motifs, random mix.
8 sujets differents, melange aleatoire. 8 verschiedene Motive, Zufallsmischung.

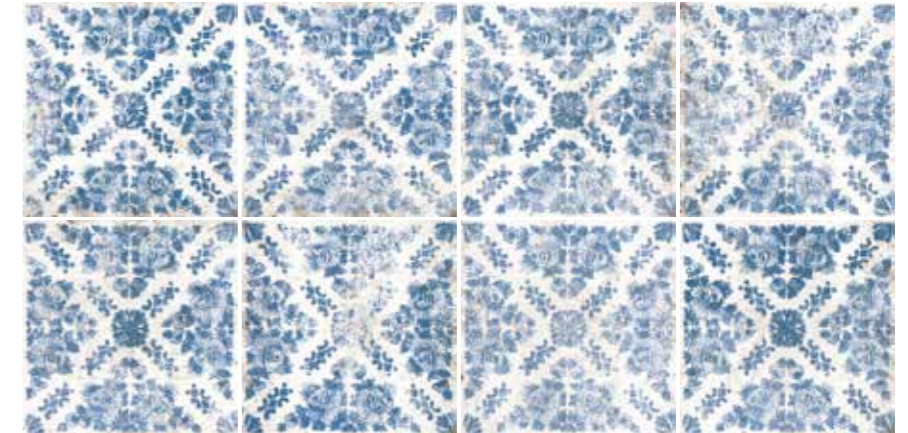

FRÜHLING DEKORE **FP2**

technical project
FP2
outdoor

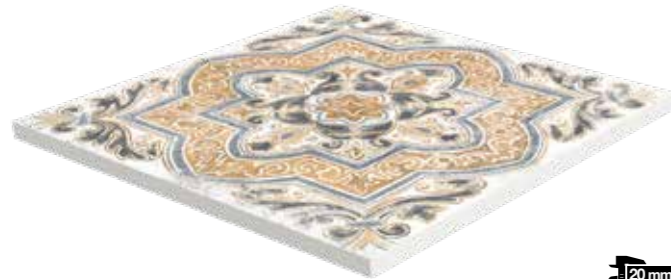

monofaccia arabisch

90x90 cm 36"x36" **FP2**

61,0x61,0 cm 24"x24" **FP2**



RS **B226**

RS **B199**



monofaccia geometrisch

90x90 cm 36"x36" **FP2**

61,0x61,0 cm 24"x24" **FP2**



RS **B226**

RS **B199**



monofaccia lillie

90x90 cm 36"x36" **FP2**

61,0x61,0 cm 24"x24" **FP2**



RS **B226**

RS **B199**

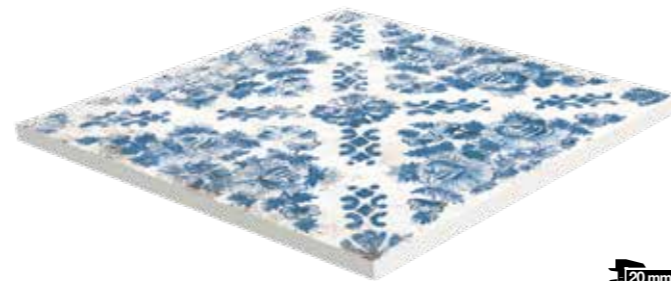

monofaccia blumen

90x90 cm 36"x36" **FP2**

61,0x61,0 cm 24"x24" **FP2**



RS **B226**

RS **B199**



floor: **FP2** Frühling Dekore Blumen 61,0x61,0 cm . 24"x24" RS
wall: Decapé Miele 26,0x160,0 cm . 10"x62" R



floor: **FP2** Frühling Dekore Blumen 61,0x61,0 cm . 24"x24" RS
wall: Decapé Miele 26,0x160,0 cm . 10"x62" R

CAROCIMENT

effetto cemento
concrete-look
effet ciment
zementoptik

grès porcellanato
porcelain stoneware . grès cérame . feinsteinzeug

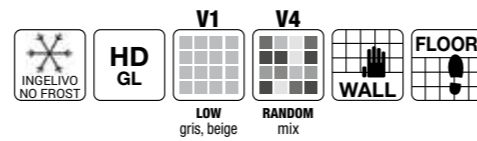

Formati
Sizes - Formats - Formate



Colori
Colours - Couleurs - Farbe



N NATURALE
NATURAL



Mix
20x20 cm . 8"x8" N

CAROCIMENT

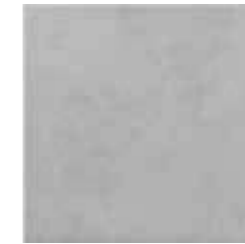

gris
20x20 cm 8"x8" **N** **A40**



beige
20x20 cm 8"x8" **N** **A40**

decori - decors - décors - dekors

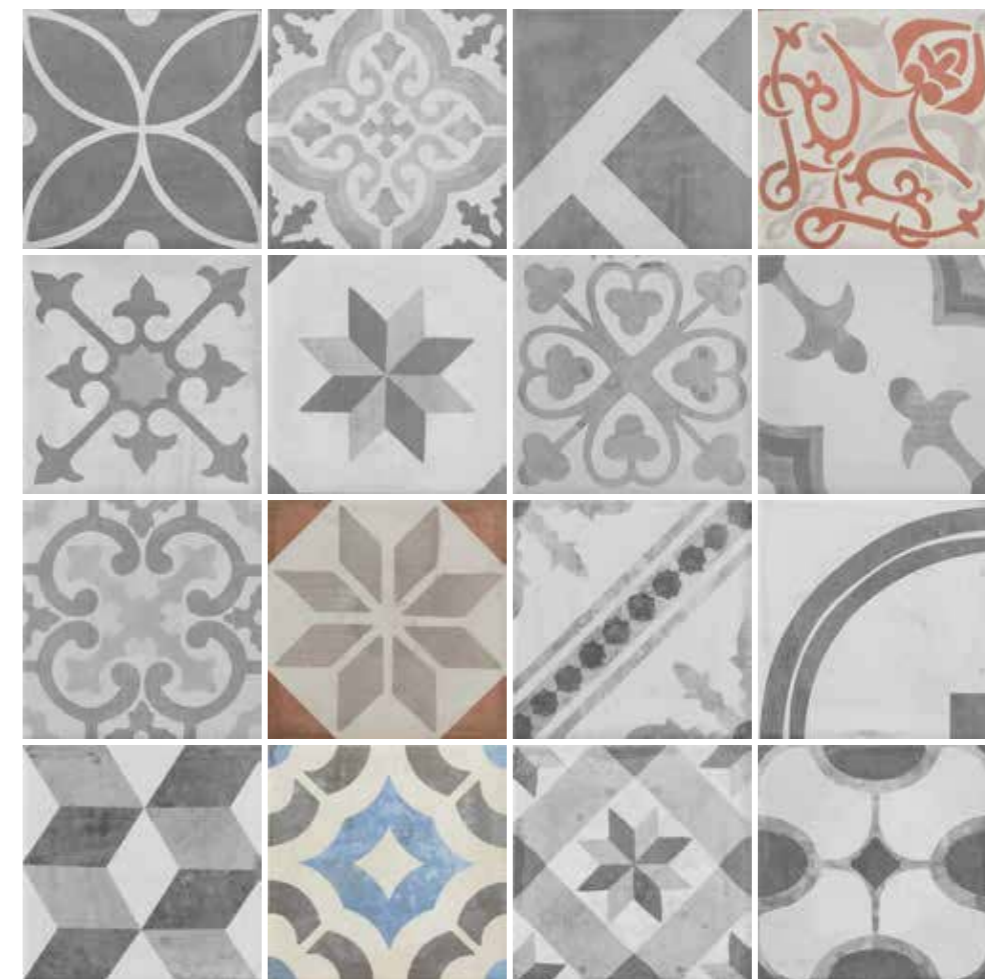

* carociment mix 20x20 cm 8"x8" **N** **A45**

* La tonalità del materiale è da ritenersi puramente indicativa.
Please consider the shades of material as indicative only.
La tonalité du matériel est tout à fait indicative.
Farbabweichungen sind möglich und können deshalb nicht beanstandet werden.

AGADIR

effetto cemento
concrete-look
effet ciment
zementoptik

grès porcellanato
porcelain stoneware . grès cérame . feinsteinzeug

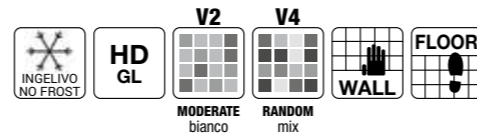

Formati
Sizes - Formats - Formate



Colori
Colours - Couleurs - Farbe



N NATURALE
NATURAL



wall: Mix 20x20 cm . 8"x8" N - Fjord Honning 20,3x122,6 cm . 8"x48" R
floor: Grey Soul Mid 61,3x122,6 cm . 24"x48" R

AGADIR

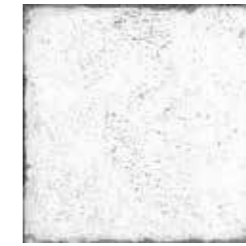

bianco
20x20 cm 8"x8" **N** **A40**

decori - decors - décors - dekors



agadir mix 20x20 cm 8"x8" **N** **A45**

decoro monofaccia - 20x20 cm 8"x8"



fiordaliso
20x20 cm 8"x8" **N** **A45**



stella alpina
20x20 cm 8"x8" **N** **A45**



viola blu
20x20 cm 8"x8" **N** **A45**



giglio nero
20x20 cm 8"x8" **N** **A45**

effetto pietra - stone-look - effet pierre - steinoptik



colosseo	70
colosseo FP2	74
durango	96
durango FP2	100
etna	76
etna FP2	82
etruria	112
la leccese	66
limestone	84
limestone FP2	90
pietre	102
santi	110
terraforte	106
tribeca	92
vals	188



IL CAVALLINO
CERAMICHE since 1968

LA LECCESE

grès porcellanato
porcelain stoneware . grès cérame . feinsteinzeug

effetto pietra
stone-look
effet pierre
steinoptik



Formati Sizes - Formats - Formate

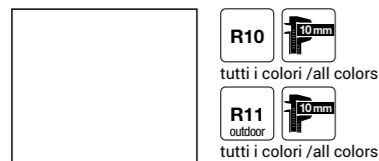

61,0x61,0 cm RS-BM / 24"x24" RS-BM
61,0x61,0 cm RS-BM - outdoor/
24"x24" RS-BM - outdoor

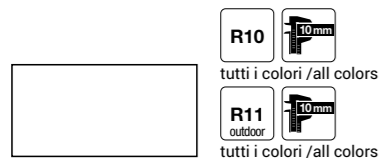

30,4x61,0 cm RS-BM /
12"x24" RS-BM
30,4x61,0 cm RS-BM - outdoor/
12"x24" RS-BM - outdoor

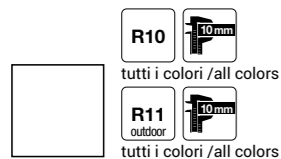

30,4x30,4 cm RS-BM /
12"x12" RS-BM
30,4x30,4 cm RS-BM - outdoor/
12"x12" RS-BM - outdoor

Colori Colours - Couleurs - Farbe



RS/BM RETTIFICATO STRUTTURATO/BORDO MOSSO
RECTIFIED TEXTURED/LIGHT EDGES

Leccese Almond
61,0x61,0 cm . 24"x24" RS-BM - 30,4x61,0 cm . 12"x24" RS-BM - 30,4x30,4 cm . 12"x12" RS-BM

LA LECCESE

LA LECCESE / DURANGO pag. 96



leccese almond

61,0x61,0 cm 24"x24"

RS/BM A196

61,0x61,0 cm 24"x24" OUTDOOR

RS/BM A197



leccese almond

30,4x61,0 cm 12"x24"

RS/BM A112

30,4x61,0 cm 12"x24" OUTDOOR

RS/BM A113



leccese almond

30,4x30,4 cm 12"x12"

RS/BM A101

30,4x30,4 cm 12"x12" OUTDOOR

RS/BM A102

pezzi speciali - special pieces - pièces spéciales - formteile

battiscopa
6,5x61,0 cm 2 1/2"x24" R P07 12



leccese almond

elemento "L" monolitico outdoor P51 2



leccese almond

step
30,4x61,0 cm 12"x24" R P90

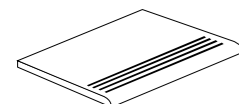

leccese almond

gradino con toro incollito
30,4x30,4 cm 12"x12" R P20

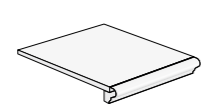

leccese almond

angolare con toro incollito
30,4x30,4 cm 12"x12" R P21

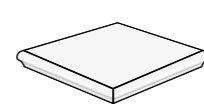

leccese almond

decori - decors - décors - dekors

mosaico burattato 36 tessere 5x5 -
30x30 cm 12"x12" 7 P71



leccese almond

Esempi di posa . Laying compositions . Exemple de pose . Verlegemuster multiformato . multiformat

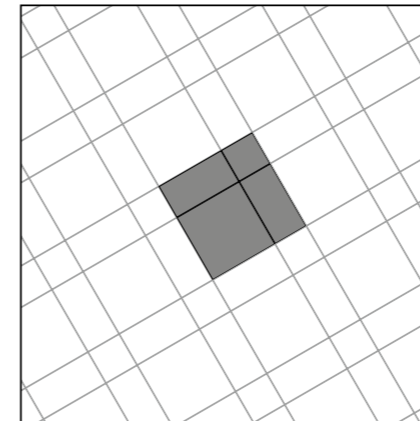

1		
61x61 - 24"x24"		44,45%
30,4x61 - 12"x24"		44,44%
30,4x30,4 - 12"x12"		11,11%

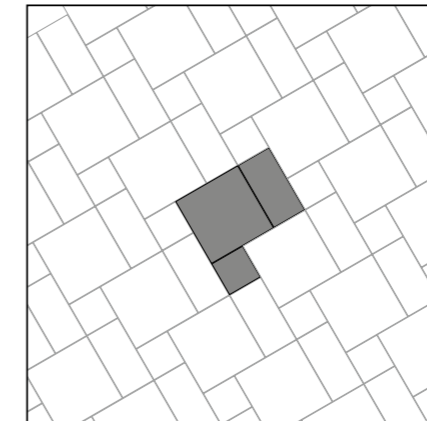

2		
61x61 - 24"x24"		57,14%
30,4x61 - 12"x24"		28,57%
30,4x30,4 - 12"x12"		14,29%

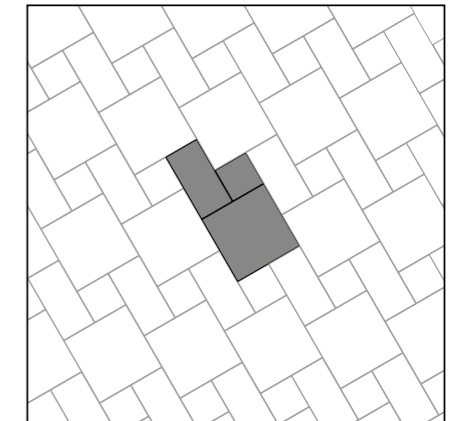

3		
61x61 - 24"x24"		57,14%
30,4x61 - 12"x24"		28,57%
30,4x30,4 - 12"x12"		14,29%

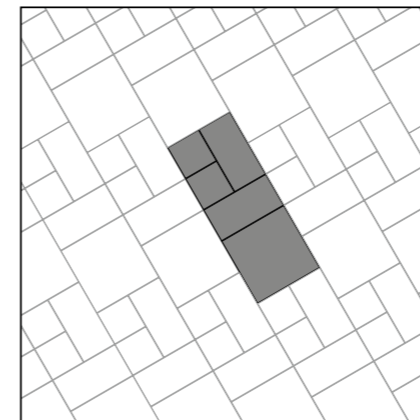

4		
61x61 - 24"x24"		40,00%
30,4x61 - 12"x24"		40,00%
30,4x30,4 - 12"x12"		20,00%

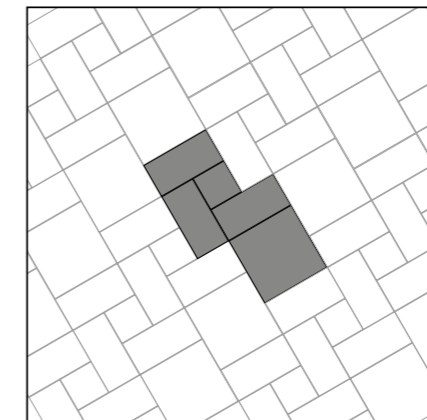

5		
61x61 - 24"x24"		36,45%
30,4x61 - 12"x24"		54,50%
30,4x30,4 - 12"x12"		9,05%

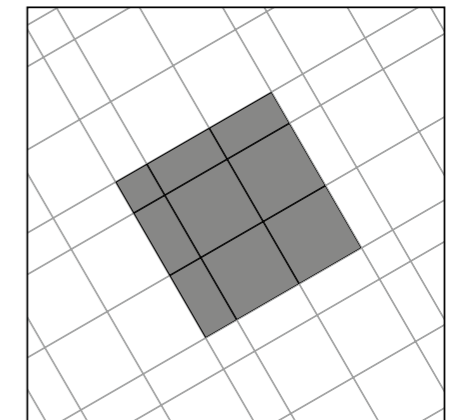

6		
61x61 - 24"x24"		64,00%
30,4x61 - 12"x24"		32,00%
30,4x30,4 - 12"x12"		4,00%

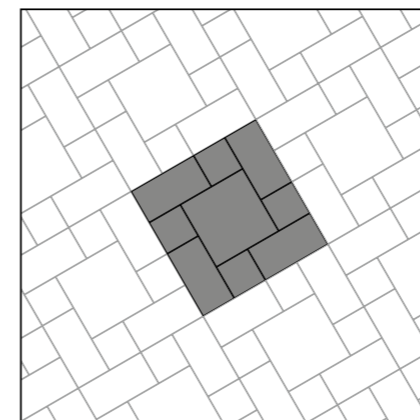

7		
61x61 - 24"x24"		25,00%
30,4x61 - 12"x24"		50,00%
30,4x30,4 - 12"x12"		25,00%

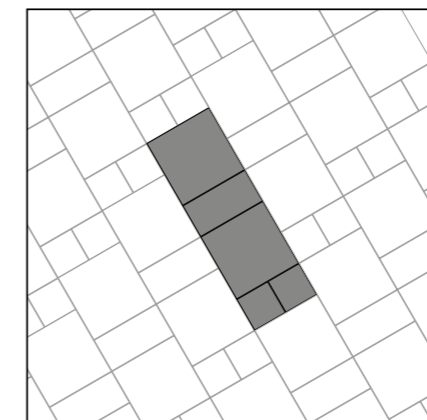

8		
61x61 - 24"x24"		66,78%
30,4x61 - 12"x24"		16,64%
30,4x30,4 - 12"x12"		16,58%

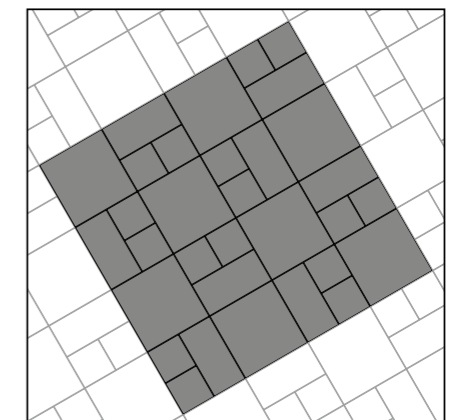

9		
61x61 - 24"x24"		50,00%
30,4x61 - 12"x24"		24,90%
30,4x30,4 - 12"x12"		25,10%

Note - Notes - Notes - Anmerkungen
I battiscopa e gli elementi "L" vengono venduti a pz. e a scatola completa. Tutti gli altri pezzi speciali vengono venduti al pezzo. I gradini vengono prodotti solo su ordinazione (tempo minimo di consegna 20 gg lavorativi).
All skirting and monolithic L elements, priced per piece, are sold in full box. All other special trims are sold by piece. Steps are produced only on request (minimum delivery terms of 20 days).
Les plinthes et élément "L" sont vendues la pièce et par boîte complète. Les autres pièces spéciales sont vendues la pièce. Le plat de marche sont produit sur demande (délai minimum de 20 jours).
Die Sockelleisten und Stufen werden pro Stk. und Vollen Kartons verkauft. Stufen und Stufenecken werden nur auf Bestellung produziert (Lieferzeiten mindesten 20 arbeitstagen ab Auftragserteilung).











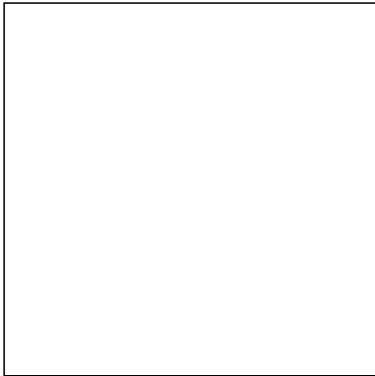

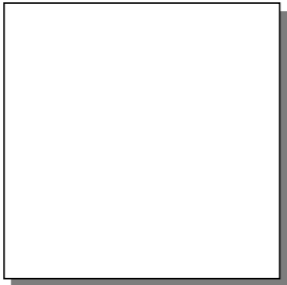
COLOSSEO

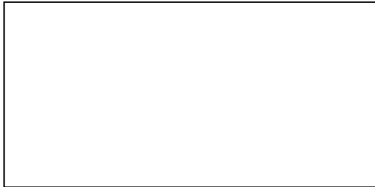
grès porcellanato
porcelain stoneware . grès cérame . feinsteinzeug

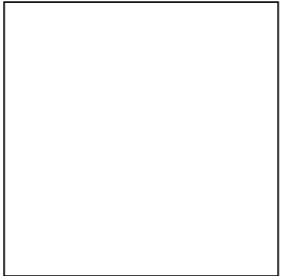
effetto pietra
stone-look
effet pierre
steinoptik

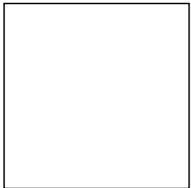

Formati
Sizes - Formats - Formate

 <p>R10  10mm beige, panna</p> <p>122,6x122,6 cm RS / 48"x48" RS</p>	<p>FP2</p>  <p>R11  20mm FP2 beige, grigio</p> <p>FP2 90x90 cm RS / 36"x36" RS</p>
 <p>R10  10mm beige, panna</p> <p>61,3x122,6 cm RS / 24"x48" RS</p>	 <p>R10  10mm tutti i colori / all colors</p> <p>90x90 cm RS / 36"x36" RS</p>
 <p>R10  10mm tutti i colori /all colors</p> <p>61,0x61,0 cm RS / 24"x24" RS</p>	
 <p>R10  9mm tutti i colori /all colors</p> <p>R11  10mm outdoor grigio, panna</p> <p>30,8x61,5 cm NS / 12"x24" NS 30,8x61,5 cm NS - outdoor/ 12"x24" NS - outdoor</p>	

Colori
Colours - Couleurs - Farbe



RS RETTIFICATO/STRUTTURATO
RECTIFIED/TEXTURED

NS NATURALE/STRUTTURATO
NATURAL/TEXTURED



Grigio
90x90 cm . 36"x36" RS

COLOSSEO



panna

122,6x122,6 cm 48"x48"	RS	A230
90x90 cm 36"x36"	RS	A220
61,3x122,6 cm 24"x48"	RS	A180
61,0x61,0 cm 24"x24"	RS	A192
30,8x61,5 cm 12"x24"	NS	A140
30,8x61,5 cm 12"x24" OUTDOOR	NS	A141



grigio

90x90 cm 36"x36"	RS	A220
61,0x61,0 cm 24"x24"	RS	A192
30,8x61,5 cm 12"x24"	NS	A140
30,8x61,5 cm 12"x24" OUTDOOR	NS	A141
FP2		
90x90 cm 36"x36" FP2	RS	A225



beige

122,6x122,6 cm 48"x48"	RS	A230
90x90 cm 36"x36"	RS	A220
61,3x122,6 cm 24"x48"	RS	A180
61,0x61,0 cm 24"x24"	RS	A192
30,8x61,5 cm 12"x24"	NS	A140

FP2

90x90 cm 36"x36" FP2	RS	A225
-----------------------------	----	------

floor: **FP2** Beige 90x90 cm . 36"x36" RS - wall: Beige 90x90 cm . 36"x36" RS



COLOSSEO

decori - decors - décors - dekors

mosaico monocolore 36 tessere 5x5 - 30x30 cm 12"x12" **P71**



panna

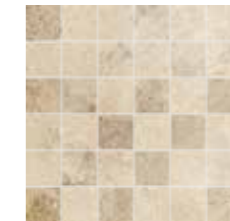

beige



grigio

mosaico asimmetrico 18 pz - 30x30 cm 12"x12" **P77**



panna



beige

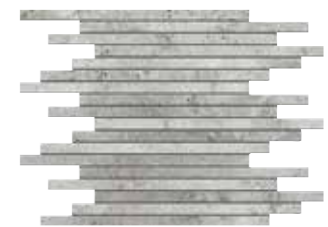

grigio

pezzi speciali - special pieces - pièces spéciales - formteile

elemento "L" monolitico outdoor **P51** **2**
15x61x4 cm 6"x24"x1 3/4"



panna



grigio

battiscopa **P07** **12**
6,5x61,0 cm 2 1/2"x24"



panna



beige



grigio

step **P92**
30,8x61,5 cm 12"x24"

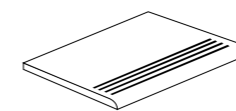

panna

beige

grigio

gradino costa retta **P32** **P31**
*34x122,6x4 cm 13"x48"x1 3/4"
34x61,0x4 cm 13"x24"x1 3/4"

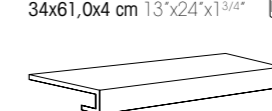

*panna

*beige

grigio

angolare costa retta dx/sx **P41** **P40**
*34x122,6x4 cm 13"x48"x1 3/4"
34x34x4 cm 13"x13"x1 3/4"

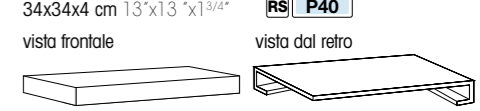

*panna

*beige

grigio

Note - Notes - Notes - Anmerkungen
I battiscopa e gli elementi "L" vengono venduti a pz. e a scatola completa. Tutti gli altri pezzi speciali vengono venduti al pezzo. I gradini vengono prodotti solo su ordinazione (tempo minimo di consegna 20 gg lavorativi).
All skirting and monolithic L elements, priced per piece, are sold in full box. All other special trims are sold by piece. Steps are produced only on request (minimum delivery terms of 20 days).
Les plinthes et élément "L" sont vendues la pièce et par boîte complète. Les autres pièces spéciales sont vendus la pièce. Le plat de marche sont produit sur demande (délai minimum de 20 jours).
Die Sockelleisten und Stufen werden pro Stk. und Vollen Kartons verkauft. Stufen und Stufenecken werden nur auf Bestellung produziert (Lieferzeiten mindesten 20 arbeitstagen ab Auftragserteilung).

COLOSSEO **FP2**

technical project
FP2
outdoor



beige

90x90 cm 36"x36" **FP2**

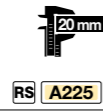

grigio

90x90 cm 36"x36" **FP2**



FP2 pezzi speciali - special pieces - pièces spéciales - formteile

elemento "L"
45x90x5 cm 18"x36"x2" **RS P101**

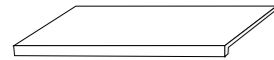

beige
grigio

angolare elemento "L"
45x90x5 cm 18"x36"x2" **RS P104**

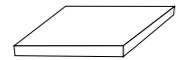

beige
grigio

griglia
20x90 cm 8"x36" **RS P118**

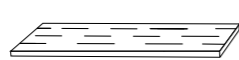

beige
grigio

griglia angolo
20x90 cm 8"x36" **RS P108 COPPIA**



beige
grigio

round lineare
45x90 cm 18"x36" **RS P111**

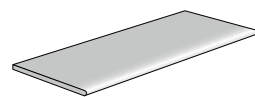

beige
grigio

round angolare
45x90 cm 18"x36" **RS P120 COPPIA**

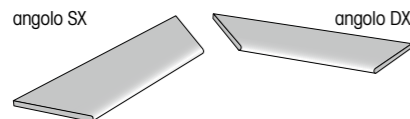

beige
grigio

angolo bordo toro
45x90 cm 18"x36" **RS P115**

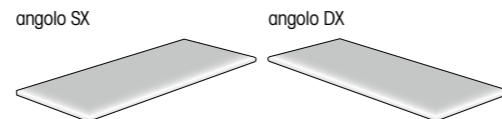

beige
grigio

Note - Notes - Notes - Anmerkungen

I pezzi speciali FP2 vengono venduti al pezzo e solo su ordinazione (tempo minimo di consegna 20 gg lavorativi dall'ordine)

The special pieces FP2 are sold by piece and only on request (minimum delivery time 20 working days from date of order).

Les pièces spéciales FP2 sont vendus à la pièce et uniquement sur commande (délai minimum de livraison 20 jours ouvrés à partir de la commande).

Spezial Teile FP2 sind pro Stück verkauft und nur auf Bestellungen produziert. (Lieferzeiten mindesten 20 arbeitstage ab Auftragbestätigung)



FP2 BEIGE 90x90 cm . 36"x36" RS
elemento "L" 45x90x5 cm_18"x36"x2"

ETNA

grès porcellanato impasto colorato
color body porcelain stoneware . grès cérame coloré dans la masse . durchgefärbtes Feinsteinzeug



effetto pietra
stone-look
effet pierre
steinoptik





Formati
Sizes - Formats - Formate

Colori
Colours - Couleurs - Farbe





R10  
tutti i colori / all colors

R11 outdoor  
tutti i colori / all colors

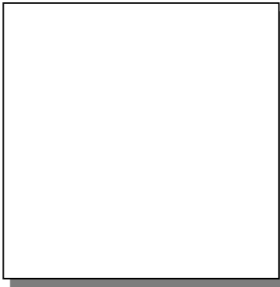

61,3x122,6 cm RS / 24"x48" RS
61,3x122,6 cm RS - outdoor /
24"x48" RS - outdoor



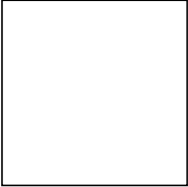

R11 FP2  
greige, anthracite

FP2 90x90 cm RS /
36"x36" RS





R10  
tutti i colori / all colors

R11 outdoor  
tutti i colori / all colors

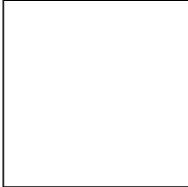

61,0x61,0 cm RS / 24"x24" RS
61,0x61,0 cm RS / 24"x24" RS - DECORO
61,0x61,0 cm RS - outdoor /
24"x24" RS - outdoor



R11 FP2  
white, beige

FP2 61,0x61,0 cm RS /
24"x24" RS



R10  
tutti i colori / all colors

30,4x61,0 cm RS / 12"x24" RS

WHITE



BEIGE



GREIGE



ANTHRACITE



Greige 61,3x122,6 cm . 24"x48" RS
61,0x61,0 cm . 24"x24" RS outdoor



white

61,3x122,6 cm 24"x48"	RS	A180
61,3x122,6 cm 24"x48" OUTDOOR	RS	A182
61,0x61,0 cm 24"x24"	RS	A192
61,0x61,0 cm 24"x24" DECORO	RS	A194
61,0x61,0 cm 24"x24" OUTDOOR	RS	A193
30,4x61,0 cm 12"x24"	RS	A110

FP2

61,0x61,0 cm 24"x24" FP2	RS	A198
--------------------------	----	------

decori - decors - décors - dekors

decoro - 61,0x61,0 cm 24"x24"  



white

61,0x61,0 cm 24"x24" DECORO 	RS	A194
---	----	------



beige

61,3x122,6 cm 24"x48"	RS	A180
61,3x122,6 cm 24"x48" OUTDOOR	RS	A182
61,0x61,0 cm 24"x24"	RS	A192
61,0x61,0 cm 24"x24" DECORO	RS	A194
61,0x61,0 cm 24"x24" OUTDOOR	RS	A193
30,4x61,0 cm 12"x24"	RS	A110

FP2

61,0x61,0 cm 24"x24" FP2	RS	A198
--------------------------	----	------

decori - decors - décors - dekors

decoro - 61,0x61,0 cm 24"x24"  



beige

61,0x61,0 cm 24"x24" DECORO 	RS	A194
---	----	------



greige

61,3x122,6 cm 24"x48"	RS	A180
61,3x122,6 cm 24"x48" OUTDOOR	RS	A182
61,0x61,0 cm 24"x24"	RS	A192
61,0x61,0 cm 24"x24" DECORO	RS	A194
61,0x61,0 cm 24"x24" OUTDOOR	RS	A193
30,4x61,0 cm 12"x24"	RS	A110

FP2

90x90 cm 36"x36" FP2	RS	A225
----------------------	----	------

decori - decors - décors - dekors

decoro - 61,0x61,0 cm 24"x24"  



greige

61,0x61,0 cm 24"x24" DECORO 	RS	A194
---	----	------



anthracite

61,3x122,6 cm 24"x48"	RS	A180
61,3x122,6 cm 24"x48" OUTDOOR	RS	A182
61,0x61,0 cm 24"x24"	RS	A192
61,0x61,0 cm 24"x24" DECORO	RS	A194
61,0x61,0 cm 24"x24" OUTDOOR	RS	A193
30,4x61,0 cm 12"x24"	RS	A110

FP2

90x90 cm 36"x36" FP2	RS	A225
----------------------	----	------

decori - decors - décors - dekors

decoro - 61,0x61,0 cm 24"x24"  



anthracite

61,0x61,0 cm 24"x24" DECORO 	RS	A194
---	----	------

ETNA

decori - decors - décors - dekors

mosaico monocolor 36 tessere 5x5 - 30x30 cm 12"x12" **P71**  7



white



beige



greige

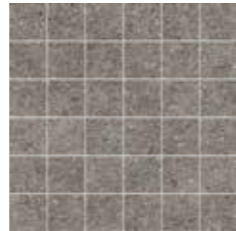

anthracite

pezzi speciali - special pieces - pièces spéciales - formteile

battiscopa
6,5x61,0 cm 2 1/2"x24" **RS P07**  12



white



beige



greige



anthracite

elemento "L" monolitico outdoor **P51**  2
15x61x4 cm 6"x24"x1 3/4"



white



greige



beige



anthracite

step
30,4x61,0 cm 12"x24" **RS P90**

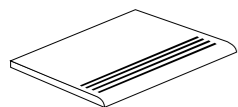

white

beige

greige

anthracite

gradino costa retta
34x122,6x4 cm 13"x48"x1 3/4" **RS P32**
34x61,0x4 cm 13"x24"x1 3/4" **RS P31**

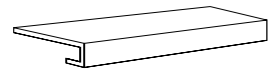

white

beige

greige

anthracite

angolare costa retta dx/sx
34x122,6x4 cm 13"x48"x1 3/4" **RS P41**
34x34x4 cm 13"x13"x1 3/4" **RS P40**

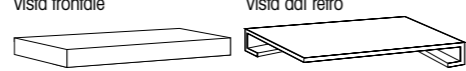

white

beige

greige

anthracite

Note - Notes - Notes - Anmerkungen

I battiscopa e gli elementi "L" vengono venduti a pz. e a scatola completa. Tutti gli altri pezzi speciali vengono venduti al pezzo. I gradini vengono prodotti solo su ordinazione (tempo minimo di consegna 20 gg lavorativi).
All skirting and monolithic L elements, priced per piece, are sold in full box. All other special trims are sold by piece. Steps are produced only on request (minimum delivery terms of 20 days).
Les plinthes et élément "L" sont vendues la pièce et par boîte complète. Les autres pièces spéciales sont vendus la pièce. Le plot de marche sont produit sur demande (délai minimum de 20 jours).
Die Sockelleisten und Stufen werden pro Stk. und Vollen Kartons verkauft. Stufen und Stufenecken werden nur auf Bestellung produziert (Lieferzeiten mindesten 20 arbeitstagen ab Auftragserteilung).



White 61,0x61,0 cm . 24"x24" RS
White Decoro 61,0x61,0 cm . 24"x24" RS



white

61,0x61,0 cm 24"x24" **FP2**

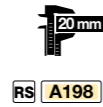

beige

61,0x61,0 cm 24"x24" **FP2**

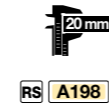

greige

90x90 cm 36"x36" **FP2**

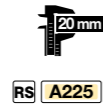

anthracite

90x90 cm 36"x36" **FP2**

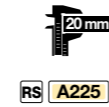

FP2 pezzi speciali - special pieces - pièces spéciales - formteile

elemento "L"

*45x90x5 cm 18"x36"x2" **RS P101**
*30x61,0x5 cm 12"x24"x2" **RS P100**

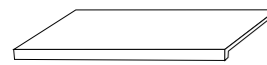

• white
• beige
* greige
* anthracite

angolare elemento "L"

*45x90x5 cm 18"x36"x2" **RS P104**
*30x30x5 cm 12"x12"x2" **RS P103**

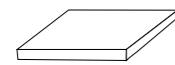

• white
• beige
* greige
* anthracite

griglia

*20x90 cm 8"x36" **RS P118**
*20x61,0 cm 8"x24" **RS P117**

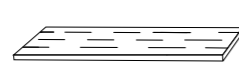

• white
• beige
* greige
* anthracite

griglia angolo

*20x90 cm 8"x36" **RS P108 COPPIA**
*20x61,0 cm 8"x24" **RS P107 COPPIA**



• white
• beige
* greige
* anthracite

round lineare

*45x90 cm 18"x36" **RS P111**
*30x61,0 cm 12"x24" **RS P110**

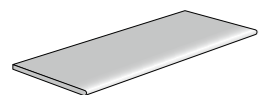

• white
• beige
* greige
* anthracite

round angolare

*45x90 cm 18"x36" **RS P120 COPPIA**
*30x61,0 cm 12"x24" **RS P119 COPPIA**

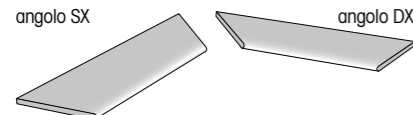

• white
• beige
* greige
* anthracite

angolo bordo toro

*45x90 cm 18"x36" **RS P115**
*30x61,0 cm 12"x24" **RS P114**

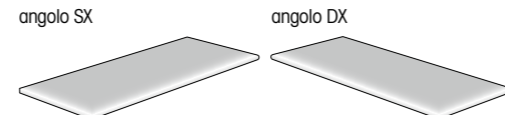

• white
• beige
* greige
* anthracite

Note - Notes - Notes - Anmerkungen

I pezzi speciali FP2 vengono venduti al pezzo e solo su ordinazione (tempo minimo di consegna 20 gg lavorativi dall'ordine)

The special pieces FP2 are sold by piece and only on request (minimum delivery time 20 working days from date of order).

Les pièces spéciales FP2 sont vendus à la pièce et uniquement sur commande (délai minimum de livraison 20 jours ouvrés à partir de la commande).

Spezial Teile FP2 sind pro Stück verkauft und nur auf Bestellungen produziert. (Lieferzeiten mindesten 20 arbeitstage ab Auftragbestätigung)



FP2 Beige
61,0x61,0 cm . 24"x24" RS

LIMESTONE

grès porcellanato impasto colorato
color body porcelain stoneware . grès cérame coloré dans la masse . durchgefärbtes Feinsteinzeug

effetto pietra
stone-look
effet pierre
steinoptik



Formati Sizes - Formats - Formate

R10

tutti i colori / all colors

R11 outdoor

tutti i colori / all colors

FP2

tutti i colori / all colors

FP2

tutti i colori / all colors

FP2

61,0x61,0 cm RS / 24"x24" RS

R10

tutti i colori / all colors

61,0x61,0 cm R / 24"x24" R

R10

tutti i colori / all colors

R11 outdoor

tutti i colori / all colors

30,4x61,0 cm R / 12"x24" R
30,8x61,5 cm N - outdoor/
12"x24" N - outdoor

Colori Colours - Couleurs - Farbe

- ICE
- GUN METAL
- COAL
- BEIGE
- ASH



floor: Beige 61,3x122,6 cm . 24"x48" R
wall: Beige 30,4x61,0 cm . 12"x24" R

N NATURALE NATURAL **R** RETTIFICATO RECTIFIED **RS** RETTIFICATO/STRUTTURATO RECTIFIED/TEXTURED

LIMESTONE



ice

61,3x122,6 cm 24"x48"	R	A180
61,3x122,6 cm 24"x48" OUTDOOR	R	A182
61,0x61,0 cm 24"x24"	R	A192
30,4x61,0 cm 12"x24"	R	A110
30,8x61,5 cm 12"x24" OUTDOOR	N	A141

FP2

61,0x61,0 cm 24"x24" FP2	RS	A198
---------------------------------	----	------

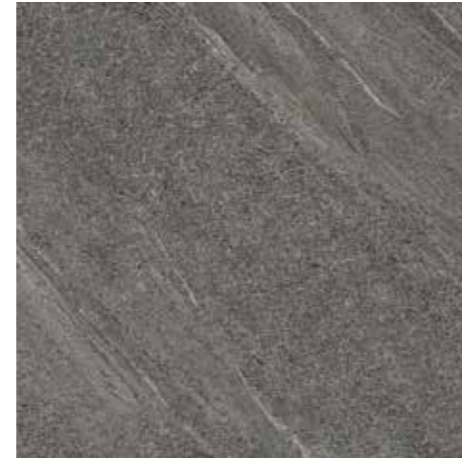

coal

61,3x122,6 cm 24"x48"	R	A180
61,3x122,6 cm 24"x48" OUTDOOR	R	A182
61,0x61,0 cm 24"x24"	R	A192
30,4x61,0 cm 12"x24"	R	A110
30,8x61,5 cm 12"x24" OUTDOOR	N	A141

FP2

61,0x61,0 cm 24"x24" FP2	RS	A198
---------------------------------	----	------



gun metal

61,3x122,6 cm 24"x48"	R	A180
61,3x122,6 cm 24"x48" OUTDOOR	R	A182
61,0x61,0 cm 24"x24"	R	A192
30,4x61,0 cm 12"x24"	R	A110
30,8x61,5 cm 12"x24" OUTDOOR	N	A141

FP2

61,0x61,0 cm 24"x24" FP2	RS	A198
---------------------------------	----	------

LIMESTONE



beige

61,3x122,6 cm 24"x48"	R	A180
61,3x122,6 cm 24"x48" OUTDOOR	R	A182
61,0x61,0 cm 24"x24"	R	A192
30,4x61,0 cm 12"x24"	R	A110
30,8x61,5 cm 12"x24" OUTDOOR	N	A141

FP2

61,0x61,0 cm 24"x24" FP2	RS	A198
---------------------------------	----	------



ash

61,3x122,6 cm 24"x48"	R	A180
61,3x122,6 cm 24"x48" OUTDOOR	R	A182
61,0x61,0 cm 24"x24"	R	A192
30,4x61,0 cm 12"x24"	R	A110
30,8x61,5 cm 12"x24" OUTDOOR	N	A141

FP2

61,0x61,0 cm 24"x24" FP2	RS	A198
---------------------------------	----	------

Ice 61,3x122,6 cm . 24"x48" R



LIMESTONE

decori - decors - décors - dekors

mosaico monocolore 36 tessere 5x5 - 30x30 cm 12"x12" **P71**  7

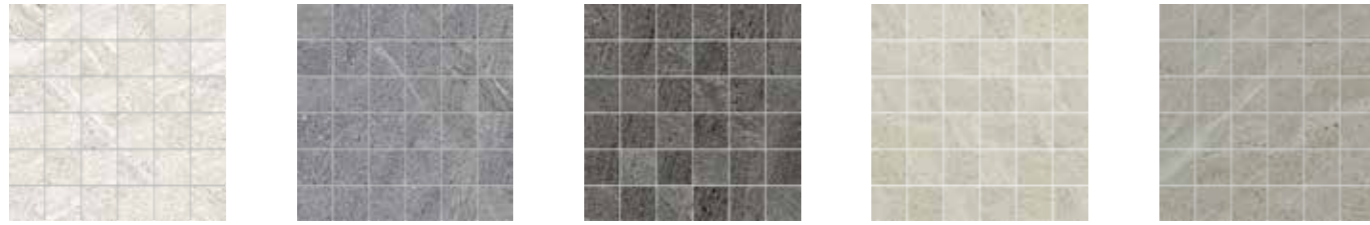

ice gun metal coal beige ash

mosaico asimmetrico 18 pz - 30x30 cm 12"x12" **P77**  9

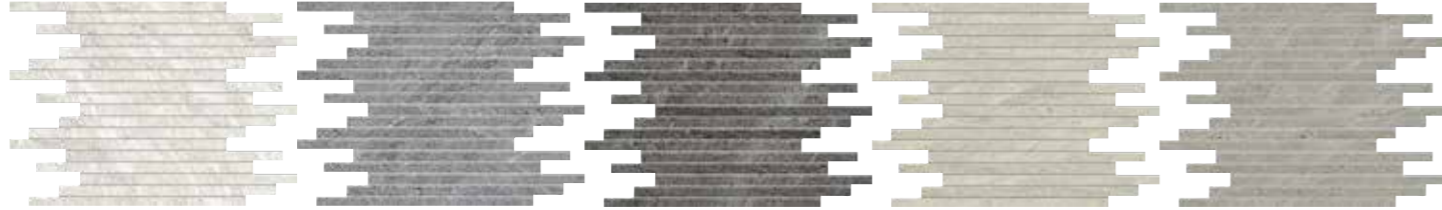

ice gun metal coal beige ash

pezzi speciali - special pieces - pièces spéciales - formteile

battiscopa
6,5x61,0 cm 2 1/2"x24" **R** **P07**  12

elemento "L" monolitico outdoor **P51**  2
15x61x4 cm 6"x24"x1 3/4"



ice
gun metal
coal
beige
ash



ice gun metal coal
beige ash

step
30,4x61,0 cm 12"x24" **R** **P90**

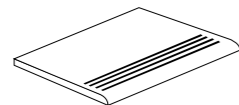

ice
gun metal
coal
beige
ash

gradino costa retta
34x122,6x4 cm 13"x48"x1 3/4" **R** **P32**
34x61,0x4 cm 13"x24"x1 3/4" **R** **P31**

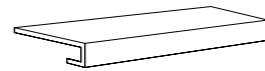

ice
gun metal
coal
beige
ash

angolare costa retta dx/sx
34x122,6x4 cm 13"x48"x1 3/4" **R** **P41**
34x34x4 cm 13"x13"x1 3/4" **R** **P40**

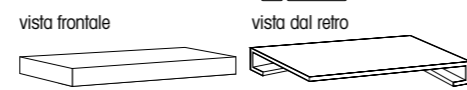

ice
gun metal
coal
beige
ash

Note - Notes - Notes - Anmerkungen
I battiscopa e gli elementi "L" vengono venduti a pz. e a scatola completa. Tutti gli altri pezzi speciali vengono venduti al pezzo. I gradini vengono prodotti solo su ordinazione (tempo minimo di consegna 20 gg lavorativi).
All skirting and monolithic L elements, priced per piece, are sold in full box. All other special trims are sold by piece. Steps are produced only on request (minimum delivery terms of 20 days).
Les plinthes et élément "L" sont vendues la pièce et par boîte complète. Les autres pièces spéciales sont vendus la pièce. Le plot de marche sont produit sur demande (délai minimum de 20 jours).
Die Sockelleisten und Stufen werden pro Stk. und Vollen Kartons verkauft. Stufen und Stufenecken werden nur auf Bestellung produziert (Lieferzeiten mindesten 20 arbeitstagen ab Auftragserteilung).



Ash
61,3x122,6 cm . 24"x48" R

LIMESTONE **FP2**

technical project
FP2
outdoor



ash

61,0x61,0 cm 24"x24" **FP2**

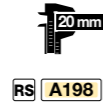

beige

61,0x61,0 cm 24"x24" **FP2**

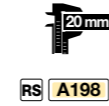

gun metal

61,0x61,0 cm 24"x24" **FP2**

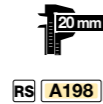

ice

61,0x61,0 cm 24"x24" **FP2**

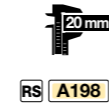

coal

61,0x61,0 cm 24"x24" **FP2**

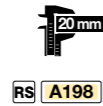

Coal 61,0x61,0 cm . 24"x24" RS - griglia 20x61,0 cm . 8"x24" - griglia angolo SX 20x61,0 cm . 8"x24" - griglia angolo DX 20x61,0 cm . 8"x24"

FP2 pezzi speciali - special pieces - pièces spéciales - formteile

elemento "L"

30x61,0x5 cm 12"x24"x2" **RS P100**

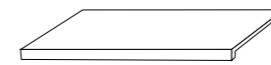

ice
gun metal
coal
beige
ash

angolare elemento "L"

30x30x5 cm 12"x12"x2" **RS P103**

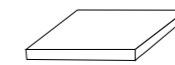

ice
gun metal
coal
beige
ash

griglia

20x61,0 cm 8"x24" **RS P117**

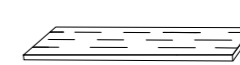

ice
gun metal
coal
beige
ash

griglia angolo

20x61,0 cm 8"x24" **RS P107 COPPIA**

angolo SX angolo DX

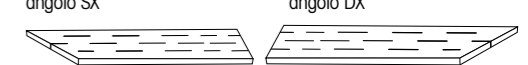

ice
gun metal
coal
beige
ash

round lineare

30x61,0 cm 12"x24" **RS P110**

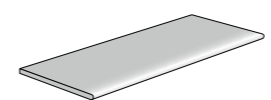

ice
gun metal
coal
beige
ash

round angolare

30x61,0 cm 12"x24" **RS P119 COPPIA**

angolo SX angolo DX



ice
gun metal
coal
beige
ash

angolo bordo toro

30x61,0 cm 12"x24" **RS P114**

angolo SX angolo DX

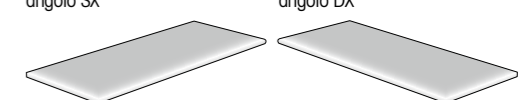

ice
gun metal
coal
beige
ash

Note - Notes - Notes - Anmerkungen

I pezzi speciali FP2 vengono venduti al pezzo e solo su ordinazione (tempo minimo di consegna 20 gg lavorativi dall'ordine).
The special pieces FP2 are sold by piece and only on request (minimum delivery time 20 working days from date of order).
Les pièces spéciales FP2 sont vendus à la pièce et uniquement sur commande (délai minimum de livraison 20 jours ouvrés à partir de la commande).
Spezial Teile FP2 sind pro Stück verkauft und nur auf Bestellungen produziert. (Lieferzeiten mindesten 20 arbeitstage ab Auftragbestätigung)

TRIBECA

grès porcellanato impasto colorato

color body porcelain stoneware . grès cérame coloré dans la masse . durchgefärbtes feinsteinzeug
61,3x122,6 cm . 24"x48" - 61,0x61,0 cm . 24"x24" - 30,8x61,5 cm . 12"x24"

grès porcellanato

porcelain stoneware . grès cérame . feinsteinzeug
20x40 cm . 8"x16" - 20x20 cm . 8"x8" - 15,1x30,6 cm . 6"x12"

Formati

Sizes - Formats - Formate



tutti i colori / all colors

61,3x122,6 cm RS / 24"x48" RS

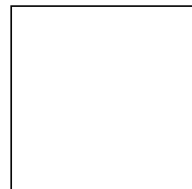

tutti i colori / all colors

61,0x61,0 cm RS / 24"x24" RS



tutti i colori / all colors



tutti i colori / all colors

30,8x61,5 cm NS / 12"x24" NS
30,8x61,5 cm NS - outdoor/
12"x24" NS - outdoor

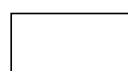

beige, grey

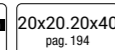

20x40 cm NS - outdoor/
8"x16" NS - outdoor



beige, grey

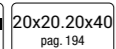

20x20 cm NS - outdoor/
8"x8" NS - outdoor



tutti i colori / all colors

15,1x30,6 cm NS - outdoor/
6"x12" NS - outdoor



effetto pietra
stone-look
effet pierre
steinoptik



WHITE



GREY



DARK GREY



BEIGE



wall: Dark Grey 61,3x122,6 cm . 24"x48" RS
floor: Beige 15,1x30,6 cm . 6"x12" NS outdoor - Elemento "L" monolitico outdoor 15x30x4 cm . 6"x12"x1^{3/4}"

TRIBECA



white

61,3x122,6 cm 24"x48"	RS	A180
61,0x61,0 cm 24"x24"	RS	A192
30,8x61,5 cm 12"x24"	NS	A140
30,8x61,5 cm 12"x24" OUTDOOR	NS	A141
15,1x30,6 cm 6"x12" OUTDOOR	NS	A01



grey

61,3x122,6 cm 24"x48"	RS	A180
61,0x61,0 cm 24"x24"	RS	A192
30,8x61,5 cm 12"x24"	NS	A140
30,8x61,5 cm 12"x24" OUTDOOR	NS	A141
20x40 cm 8"x16" OUTDOOR	NS	A51
20x20 cm 8"x8" OUTDOOR	NS	A43
15,1x30,6 cm 6"x12" OUTDOOR	NS	A01



dark grey

61,3x122,6 cm 24"x48"	RS	A180
61,0x61,0 cm 24"x24"	RS	A192
30,8x61,5 cm 12"x24"	NS	A140
30,8x61,5 cm 12"x24" OUTDOOR	NS	A141
15,1x30,6 cm 6"x12" OUTDOOR	NS	A01



beige

61,3x122,6 cm 24"x48"	RS	A180
61,0x61,0 cm 24"x24"	RS	A192
30,8x61,5 cm 12"x24"	NS	A140
30,8x61,5 cm 12"x24" OUTDOOR	NS	A141
20x40 cm 8"x16" OUTDOOR	NS	A51
20x20 cm 8"x8" OUTDOOR	NS	A43
15,1x30,6 cm 6"x12" OUTDOOR	NS	A01

TRIBECA

decori - decors - décors - dekors
mosaico esagona - 30x30 cm 12"x12" P78 7



white grey dark grey beige
mosaico basket - 30x30 cm 12"x12" - tessere: 2,3x2,3 . 1"x1" - 2,3x4,8 . 1"x2" - 4,8x4,8 . 2"x2" - 4,8x7,3 . 2"x3" P76 7



white grey dark grey beige
mosaico monocolor 36 tessere 5x5 - 30x30 cm 12"x12" P71 7

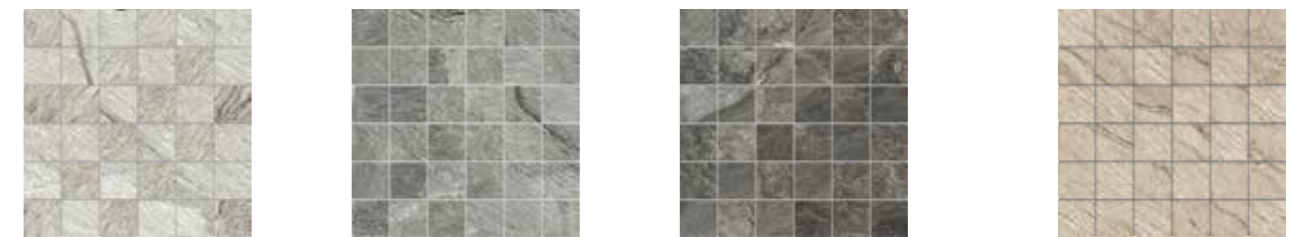

white grey dark grey beige
pezzi speciali - special pieces - pièces spéciales - formteile

elemento "L" monolitico outdoor P50 4
15x30x4 cm 6"x12"x1 3/4"



step
30,8x61,5 cm 12"x24" N P90

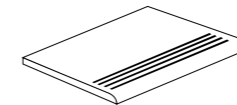

white
grey
dark grey
beige

battiscopa
*6,5x61,0 cm 2 1/2"x24" R P07 12
*6,5x40,0 cm 2 1/2"x16" N P02 20



gradino costa retta
34x122,6x4 cm 13"x48"x1 3/4" R P32
34x61,0x4 cm 13"x24"x1 3/4" R P31

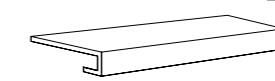

white
grey
dark grey
beige

angolare costa retta dx/sx
34x122,6x4 cm 13"x48"x1 3/4" R P41
34x34x4 cm 13"x13"x1 3/4" R P40

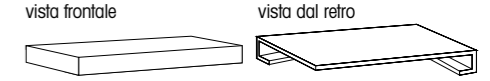

white
grey
dark grey
beige

Note - Notes - Notes - Anmerkungen
I battiscopa e gli elementi "L" vengono venduti a pz. e a scatola completa. Tutti gli altri pezzi speciali vengono venduti al pezzo. I gradini vengono prodotti solo su ordinazione (tempo minimo di consegna 20 gg lavorativi).
All skirting and monolithic L elements, priced per piece, are sold in full box. All other special items are sold by piece. Steps are produced only on request (minimum delivery terms of 20 days).
Les plinthes et élément "L" sont vendues la pièce et par boîte complète. Les autres pièces spéciales sont vendues la pièce. Le plat de marche sont produit sur demande (délai minimum de 20 jours).
Die Sockelleisten und Stufen werden pro Stk. und Vollen Kartons verkauft. Stufen und Stufenecken werden nur auf Bestellung produziert (Lieferzeiten mindesten 20 arbeitstagen ab Auftragserteilung).

DURANGO

grès porcellanato impasto colorato
color body porcelain stoneware . grès cérame coloré dans la masse . durchgefärbtes feinsteinzeug

effetto pietra
stone-look
effet pierre
steinoptik



Formati

Sizes - Formats - Formate

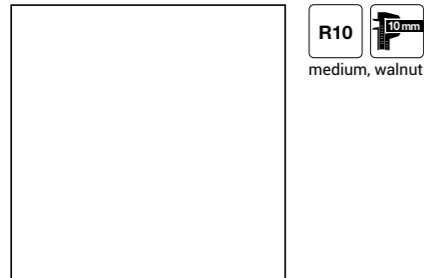

R10
10mm
medium, walnut

90x90 cm RS / 36"x36" RS



R10
10mm
tutti i colori / all colors

61,0x61,0 cm RS / 24"x24" RS

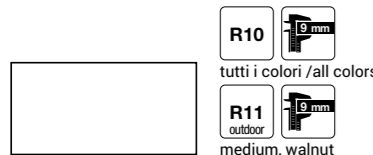

R10
9mm
tutti i colori / all colors
R11
9mm
outdoor
medium, walnut

30,8x61,5 cm NS / 12"x24" NS
30,8x61,5 cm NS - outdoor/
12"x24" NS - outdoor
30,4x61,0 cm RS / 12"x24" RS



R10
9mm
tutti i colori / all colors

30,4x30,4 cm RS /
12"x12" RS

I formati 61,0x61,0 - 30,4x61,0 - 30,4x30,4 sono modulari tra loro. Per schemi di posa vedi pag. 69.
The sizes 61.0x61.0 - 30.4x61.0 - 30.4x30.4 are combined laying. For laying patterns see page 69.
Les formats 61.0x61.0 - 30.4x61.0 - 30.4x30.4 sont modulaires entre eux. Pour les plans de pose, voir page 69.
Die Formate 61.0x61.0 - 30.4x61.0 - 30.4x30.4 sind untereinander modular aufgebaut. Zum Verlegebeispiele siehe Seite 69.



Colori

Colours - Couleurs - Farbe



MEDIUM

WALNUT

WASHED

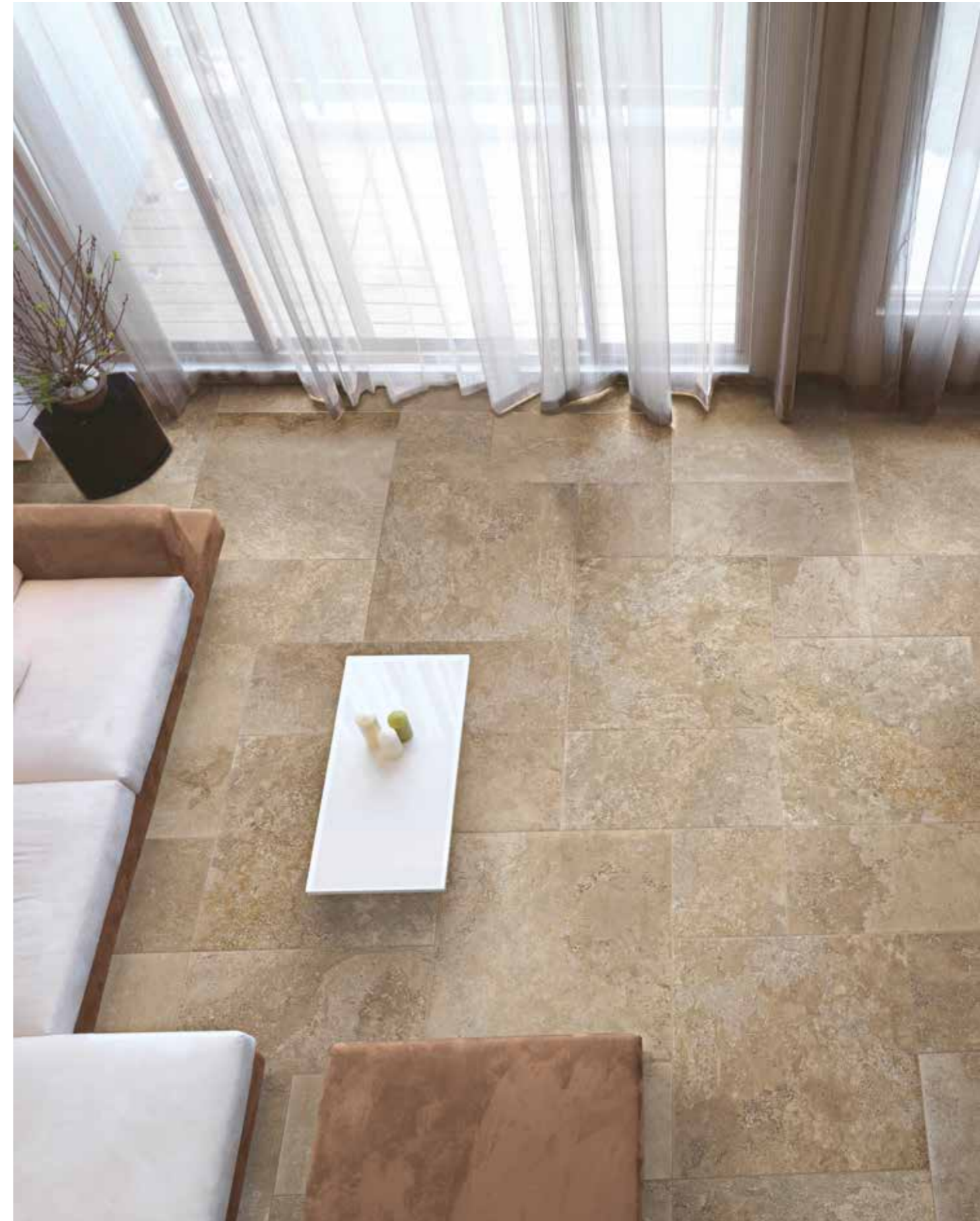

Walnut
61,0x61,0 cm . 24"x24" RS - 30,4x61,0 cm . 12"x24" RS - 30,4x30,4 cm . 12"x12" RS

decori - decors - décors - dekors



medium

90x90 cm 36"x36"	RS	A220
61,0x61,0 cm 24"x24"	RS	A192
30,8x61,5 cm 12"x24"	NS	A140
30,8x61,5 cm 12"x24" OUTDOOR	NS	A141
30,4x61,0 cm 12"x24"	RS	A110
30,4x30,4 cm 12"x12"	RS	A100

FP2

61,0x61,0 cm 24"x24" FP2	RS	A198
--------------------------	----	------



walnut

90x90 cm 36"x36"	RS	A220
61,0x61,0 cm 24"x24"	RS	A192
30,8x61,5 cm 12"x24"	NS	A140
30,8x61,5 cm 12"x24" OUTDOOR	NS	A141
30,4x61,0 cm 12"x24"	RS	A110
30,4x30,4 cm 12"x12"	RS	A100



washed

61,0x61,0 cm 24"x24"	RS	A192
30,8x61,5 cm 12"x24"	NS	A140
30,4x61,0 cm 12"x24"	RS	A110
30,4x30,4 cm 12"x12"	RS	A100

Washed 61,0x61,0 cm . 24"x24" RS



mosaico monocolore 36 tessere 5x5 - 30x30 cm 12"x12" P71 7



medium



walnut



washed

mosaico basket - 30x30 cm 12"x12" P76 7
tessere: 2,3x2,3 . 1"x1" - 2,3x4,8 . 1"x2" - 4,8x4,8 . 2"x2" - 4,8x7,3 . 2"x3"



medium



walnut



washed

pezzi speciali - special pieces - pièces spéciales - formteile

elemento "L" monolitico outdoor P51 2
15x61x4 cm 6"x24"x1 3/4"



medium



walnut

battiscopa
6,5x61,0 cm 2 1/2"x24" R P07 12



medium



walnut



washed

step
30,8x61,5 cm 12"x24" N P90

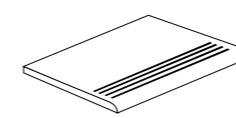

medium

walnut

washed

gradino costa retta
34x61,0x4 cm 13"x24"x1 3/4" R P31

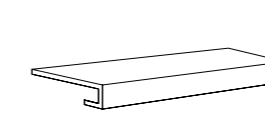

medium

walnut

washed

angolare costa retta dx/sx
34x34x4 cm 13"x13"x1 3/4" R P40

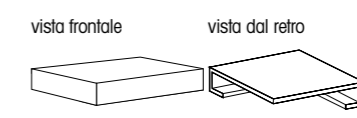

medium

walnut

washed

I formati 61,0x61,0 - 30,4x61,0 - 30,4x30,4 sono modulari tra loro. Per schemi di posa vedi pag. 69.
The sizes 61.0x61.0 - 30.4x61.0 - 30.4x30.4 are combined laying. For laying patterns see page 69.
Les formats 61.0x61.0 - 30.4x61.0 - 30.4x30.4 sont modulaires entre eux. Pour les plans de pose, voir page 69.
Die Formate 61.0x61.0 - 30.4x61.0 - 30.4x30.4 sind untereinander modular aufgebaut. Zum Verlegebeispiele siehe Seite 69.

Note - Notes - Notes - Anmerkungen
I battiscopa e gli elementi "L" vengono venduti a pz. e a scatola completa. Tutti gli altri pezzi speciali vengono venduti al pezzo. I gradini vengono prodotti solo su ordinazione (tempo minimo di consegna 20 gg lavorativi).
All skirting and monolithic L elements, priced per piece, are sold in full box. All other special trims are sold by piece. Steps are produced only on request (minimum delivery terms of 20 days).
Les plinthes et élément "L" sont vendues la pièce et par boîte complète. Les autres pièces spéciales sont vendues la pièce. Le plat de marche sont produit sur demande (délai minimum de 20 jours).
Die Sockelleisten und Stufen werden pro Stk. und Vollen Kartons verkauft. Stufen und Stufenecken werden nur auf Bestellung produziert (Lieferzeiten mindesten 20 arbeitstagen ab Auftragserteilung).

DURANGO **FP2**

technical project
FP2
outdoor



medium

61,0x61,0 cm 24"x24" **FP2**

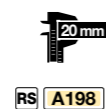

FP2 pezzi speciali - special pieces - pièces spéciales - formteile

elemento "L"
30x61,0x5 cm 12"x24"x2" **RS P100**



medium

angolare elemento "L"
30x30x5 cm 12"x12"x2" **RS P103**

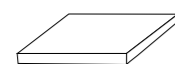

medium

griglia
20x61,0 cm 8"x24" **RS P117**

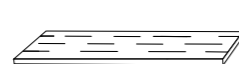

medium

griglia angolo
20x61,0 cm 8"x24" **RS P107 COPPIA**



medium

round lineare
30x61,0 cm 12"x24" **RS P110**

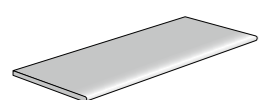

medium

round angolare
30x61,0 cm 12"x24" **RS P119 COPPIA**

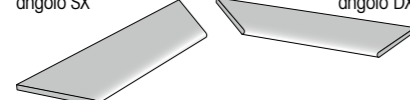

medium

angolo bordo toro
30x61,0 cm 12"x24" **RS P114**

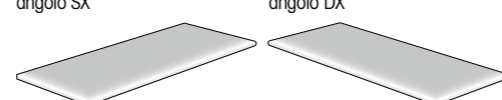

medium

Note - Notes - Notes - Anmerkungen

I pezzi speciali FP2 vengono venduti al pezzo e solo su ordinazione (tempo minimo di consegna 20 gg lavorativi dall'ordine)

The special pieces FP2 are sold by piece and only on request (minimum delivery time 20 working days from date of order).

Les pièces spéciales FP2 sont vendus à la pièce et uniquement sur commande (délai minimum de livraison 20 jours ouvrés à partir de la commande).

Spezial Teile FP2 sind pro Stück verkauft und nur auf Bestellungen produziert. (Lieferzeiten mindesten 20 arbeitstage ab Auftragbestätigung)

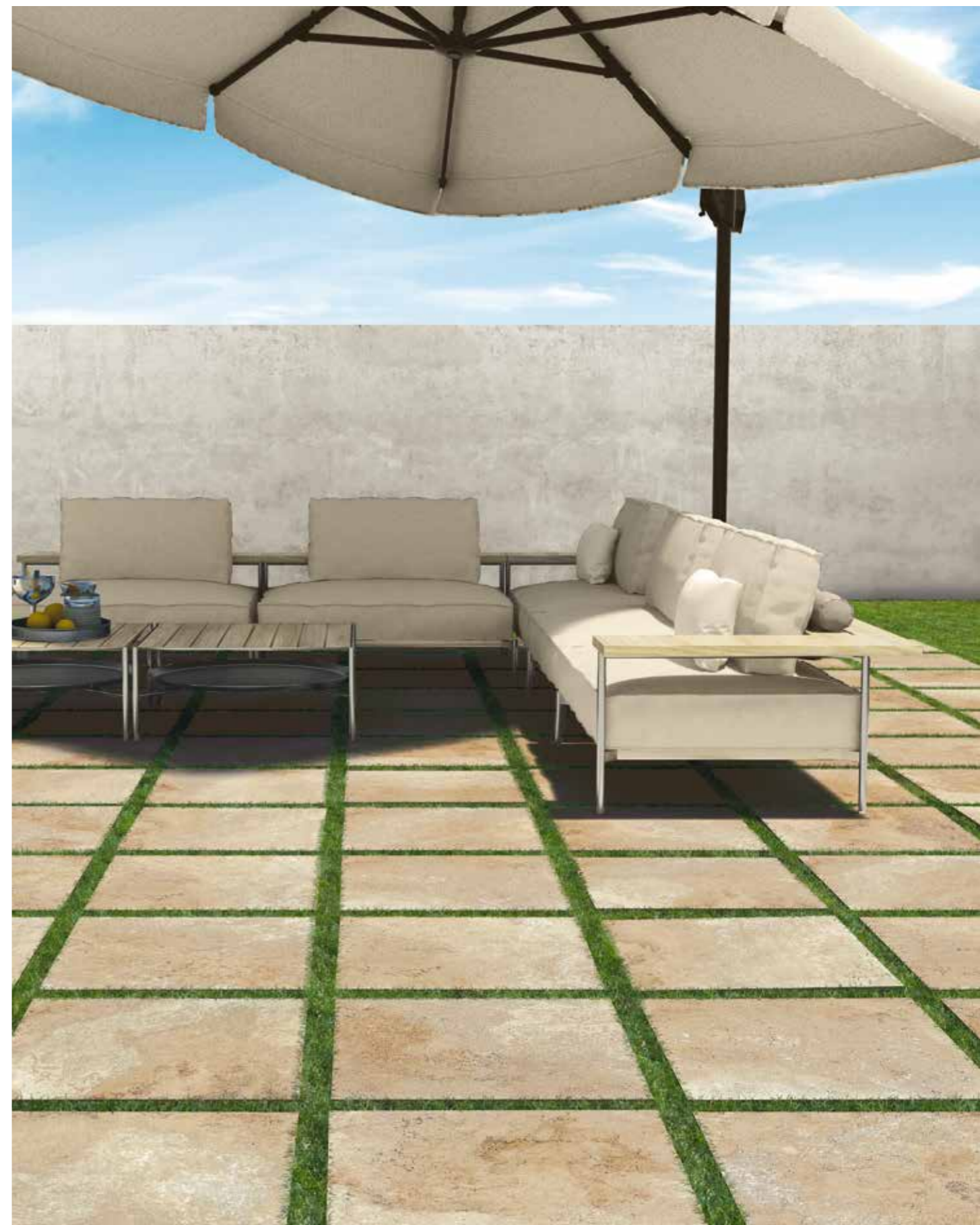

FP2 Medium
61,0x61,0 cm . 24"x24" **RS**

PIETRE

grès porcellanato
porcelain stoneware . grès cérame . feinsteinzeug

effetto pietra
stone-look
effet pierre
steinoptik



Formati
Sizes - Formats - Formate



30,8x61,5 cm NS - outdoor/
12"x24" NS - outdoor



30,4x61,0 cm RS /
12"x24" RS

*rivestimento per interno piscine
covering for indoor swimming pools
revêtement pour l'intérieur des piscines
Verkleidung für Schwimmbäder

NS NATURALE/STRUTTURATO
NATURAL/TEXTURED

RS RETTIFICATO/STRUTTURATO
RECTIFIED/TEXTURED

Colori
Colours - Couleurs - Farbe



PIETRA DI SERRA



PIETRA DI BALI



Pietra di Bali
30,4x61,0 cm .12"x24" RS



Pietra di Serra
30,8x61,5 cm .12"x24" NS outdoor

PIETRE



pietra di serra

30,8x61,5 cm 12"x24" OUTDOOR

NS A141



***pietra di bali**

30,4x61,0 cm 12"x24"

RS A110

*rivestimento per interno piscine
covering for indoor swimming pools
revêtement pour l'intérieur des piscines
Verkleidung für Schwimmbäder

pezzi speciali - special pieces - pièces spéciales - formteile

battiscopa
*7,5x61,5 cm 3"x24" NS P10 12
*7,5x61,0 cm 3"x24" RS P07 12

elemento "L" monolitico outdoor R11 P51 2
15x61x4 cm 6"x24"x1 3/4"



*pietra di serra

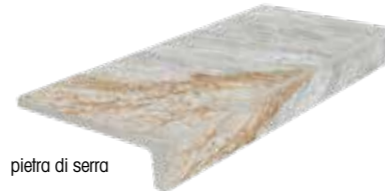

pietra di serra



*pietra di bali



pietra di bali

step
30,8x61,5 cm 12"x24" NS R11 P92

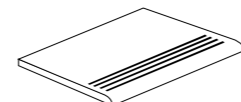

pietra di serra

Note - Notes - Notes - Anmerkungen
I battiscopa e gli elementi "L" vengono venduti a pz. e a scatola completa. Tutti gli altri pezzi speciali vengono venduti al pezzo. I gradini vengono prodotti solo su ordinazione (tempo minimo di consegna 20 gg lavorativi).
All skirting and monolithic L elements, priced per piece, are sold in full box. All other special trims are sold by piece. Steps are produced only on request (minimum delivery terms of 20 days).
Les plinthes et élément "L" sont vendues la pièce et par boîte complète. Les autres pièces spéciales sont vendus la pièce. Le plat de marche sont produit sur demande (délai minimum de 20 jours).
Die Sockelleisten und Stufen werden pro Stk. und Vollen Kartons verkauft. Stufen und Stufenecken werden nur auf Bestellung produziert (Lieferzeiten mindesten 20 arbeitstagen ab Auftragserteilung).

PIETRE

sviluppo grafico - design development - développement graphique - grafische entwicklung
(40 grafiche diverse - 40 different design - 40 graphiques différents - 40 verschiedene Grafische)



pietra di serra
30,8x61,5 cm NS
12"x24" NS outdoor



pietra di bali
30,4x61,0 cm RS
12"x24" RS

TERRAFORTE

grès porcellanato
porcelain stoneware . grès cérame . feinsteinzeug

effetto pietra
stone-look
effet pierre
steinoptik



Formati

Sizes - Formats - Formate



30,8x61,5 cm NS-BD - outdoor /
12"x24" NS-BD - outdoor



30,6x30,6 cm NS-BD - outdoor /
12"x12" NS-BD - outdoor

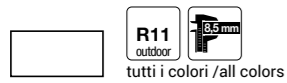

15,1x30,6 cm NS-BD - outdoor /
6"x12" NS-BD - outdoor

Il formato 30,8x61,5 non è modulare con i formati 15,1x30,6 e 30,6x30,6.
Combined laying is not possible because size 30,8x61,5 can not be modular with 15,1x30,6 and 30,6x30,6.
Le format 30,8x61,5 n'est pas modulable aux format 15,1x30,6 at 30,6x30,6.
Das Format 30,8x61,5 ist nicht modular mit die Formate 15,1x30,6 und 30,6x30,6.

NS/BD NATURALE STRUTTURATO/BORDO DRITTO
NATURAL TEXTURED/STRAIGHT EDGES

Colori

Colours - Couleurs - Farbe



BIANCO

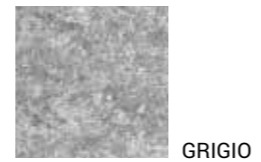

GRIGIO



CENERE



RUGGINE

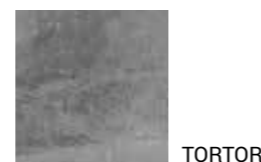

TORTORA



DORATO



CUOIO

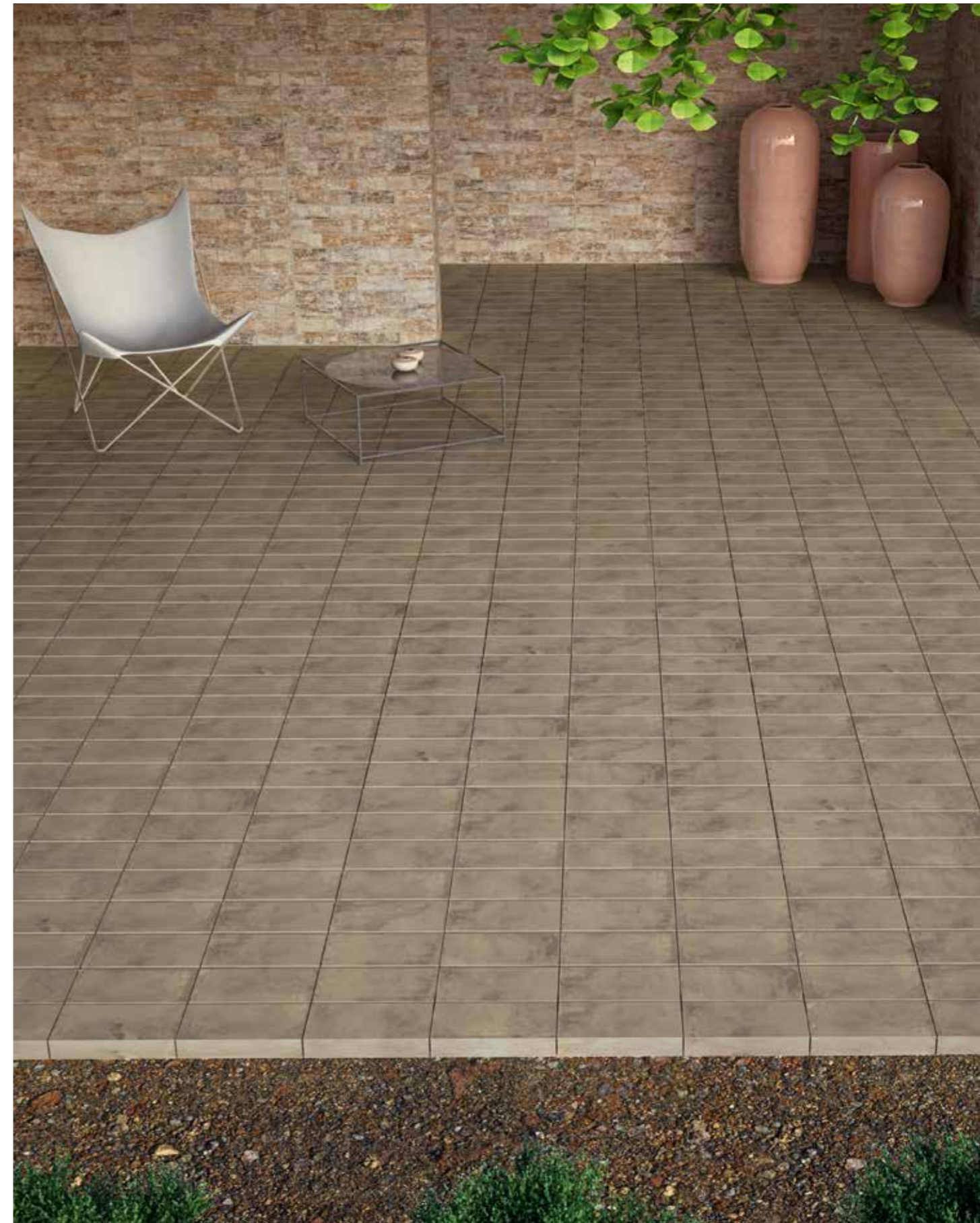

Tortora 15,1x30,6 cm . 6"x12" NS/BD outdoor
elemento "L" monolitico outdoor 15x30x4 cm . 6"x12"x1^{3/4}"

TERRAFORTE



bianco

30,8x61,5 cm 12"x24" OUTDOOR **NS/BD** **A141**

30,6x30,6 cm 12"x12" OUTDOOR **NS/BD** **A130**

15,1x30,6 cm 6"x12" OUTDOOR **NS/BD** **A01**



grigio

30,8x61,5 cm 12"x24" OUTDOOR **NS/BD** **A141**

30,6x30,6 cm 12"x12" OUTDOOR **NS/BD** **A130**

15,1x30,6 cm 6"x12" OUTDOOR **NS/BD** **A01**



cenere

15,1x30,6 cm 6"x12" OUTDOOR **NS/BD** **A01**



dorato

30,8x61,5 cm 12"x24" OUTDOOR **NS/BD** **A141**

30,6x30,6 cm 12"x12" OUTDOOR **NS/BD** **A130**

15,1x30,6 cm 6"x12" OUTDOOR **NS/BD** **A01**



cuoio

15,1x30,6 cm 6"x12" OUTDOOR **NS/BD** **A01**



ruggine

15,1x30,6 cm 6"x12" OUTDOOR **NS/BD** **A01**



tortora

15,1x30,6 cm 6"x12" OUTDOOR **NS/BD** **A01**



Dorato 15,1x30,6 cm . 6"x12" NS/BD outdoor
Elemento "L" monolitico outdoor 15x30x4 cm . 6"x12"x1^{3/4}"

pezzi speciali - special pieces - pièces spéciales - formteile

battiscopa **P08** 36
7,5x30,6 cm 3"x12"



elemento "L" monolitico outdoor **P50** 4
15x30x4 cm 6"x12"x1^{3/4}"

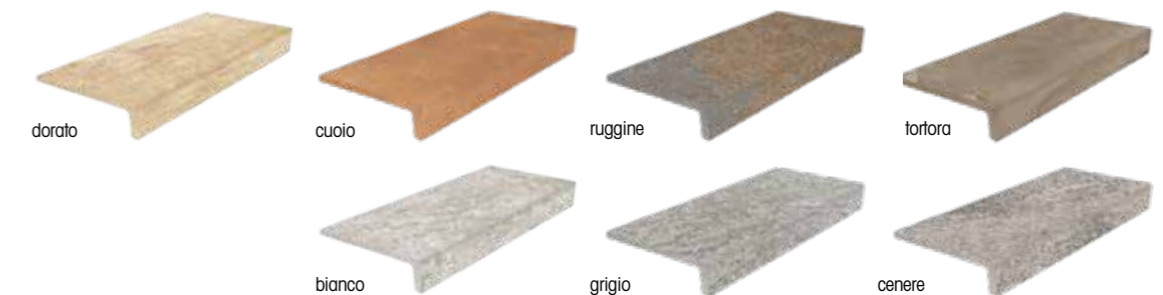

Note - Notes - Notes - Anmerkungen
I battiscopa e gli elementi "L" vengono venduti a pz. e a scatola completa. - All skirting and monolithic L elements, priced per piece, are sold in full box.
Les plinthes et élément "L" sont vendues la pièce et par boîte complète. - Die Sockelleisten und Stufen werden pro Stk. und Vollen Kartons verkauft.

Il formato 30,8x61,5 non è modulare con il formato 15,1x30,6.
Combined laying is not possible because size 30,8x61,5 can not be modular with 15,1x30,6.
Le format 30,8x61,5 n'est pas modulable aux format 15,1x30,6.
Das Format 30,8x61,5 ist nicht modular mit die Formate 15,1x30,6.

SANTI

effetto pietra
stone-look
effet pierre
steinoptik

grès porcellanato
porcelain stoneware . grès cérame . feinsteinzeug



Formati
Sizes - Formats - Formate

Colori
Colours - Couleurs - Farbe

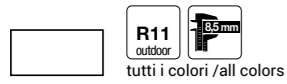

15,1x30,6 cm NS-BD - outdoor/
6"x12" NS-BD - outdoor

NS/BD NATURALE STRUTTURATO/BORDO DRITTO
NATURAL TEXTURED/STRAIGHT EDGES



San Bartolomeo 15,1x30,6 cm . 6"x12" NS/BD outdoor - Elemento "L" monolitico outdoor 15x30x4 cm . 6"x12"x1³/₄"

SANTI



san bartolomeo
15,1x30,6 cm 6"x12" OUTDOOR NS/BD A01



sant' antonio
15,1x30,6 cm 6"x12" OUTDOOR NS/BD A01

pezzi speciali - special pieces - pièces spéciales - formteile

elemento "L" monolitico outdoor P50 4
15x30x4 cm 6"x12"x1³/₄"

battiscopa P08 36
7,5x30,6 cm 3"x12"



Note - Notes - Notes - Anmerkungen
I battiscopa e gli elementi "L" vengono venduti a pz. e a scatola completa. - All skirting and monolithic L elements, priced per piece, are sold in full box.
Les plinthes et élément "L" sont vendues la pièce et par boîte complète. - Die Sockelleisten und Stufen werden pro Stk. und Vollen Kartons verkauft.



Sant'Antonio 15,1x30,6 cm . 6"x12" NS/BD outdoor - Elemento "L" monolitico outdoor 15x30x4 cm . 6"x12"x1³/₄"

ETRURIA

grès porcellanato
porcelain stoneware . grès cérame . feinsteinzeug

effetto pietra
stone-look
effet pierre
steinoptik



Formati
Sizes - Formats - Formate



30,6x30,6 cm NS-BM - outdoor/
12"x12" NS-BM - outdoor



15,1x30,6 cm NS-BM - outdoor/
6"x12" NS-BM - outdoor

Formati 30,6x30,6 e 15,1x30,6 prodotti con bordi irregolari e angoli arrotondati.
30,6x30,6 and 15,1x30,6 sizes produced with uneven edges and rounded corners.
Formats 30,6x30,6 et 15,1x30,6 produits avec bords irréguliers et angles arrondis.
Format 30,6x30,6 und 15,1x30,6, mit unregelmäßigen Kanten und abgerundeten Ecken.

Materiale non esattamente calibrato; prevedere fuga di 5 mm.
Calibration of this product is not exact; please consider a 5 mm joint.
Matériel non calibré de manière précise; prévoir un joint de 5 mm.
Nicht exakt rektifiziertes Material, es muss eine Fuge von 5 mm vorgesehen werden.

NS/BM NATURALE STRUTTURATO/BORDO MOSSO
NATURAL TEXTURED/SLIGHT EDGES

Colori
Colours - Couleurs - Farbe

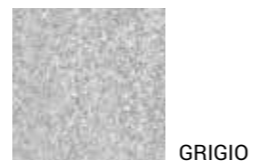

GRIGIO

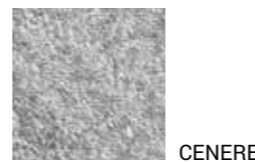

CENERE



BEIGE

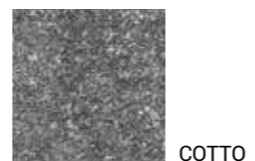

COTTO



Beige 30,6x30,6 cm . 12"x12" NS/BM outdoor
elemento "L" monolitico outdoor 15x30x4 cm . 6"x12"x1^{3/4}"



grigio

30,6x30,6 cm 12"x12" OUTDOOR **NS/BM A133**
 15,1x30,6 cm 6"x12" OUTDOOR **NS/BM A02**



beige

30,6x30,6 cm 12"x12" OUTDOOR **NS/BM A133**
 15,1x30,6 cm 6"x12" OUTDOOR **NS/BM A02**



cenere

30,6x30,6 cm 12"x12" OUTDOOR **NS/BM A133**
 15,1x30,6 cm 6"x12" OUTDOOR **NS/BM A02**



coffo

30,6x30,6 cm 12"x12" OUTDOOR **NS/BM A133**
 15,1x30,6 cm 6"x12" OUTDOOR **NS/BM A02**

Grigio 30,6x30,6 cm . 12"x12" NS/BM **outdoor**
 15,1x30,6 cm . 6"x12" NS/BM **outdoor**



Beige 30,6x30,6 cm . 12"x12" NS/BM **outdoor**



Cenere 15,1x30,6 cm . 6"x12" NS/BM **outdoor**



Coffo 15,1x30,6 cm . 6"x12" NS/BM **outdoor**



pezzi speciali - special pieces - pièces spéciales - formteile

battiscopa **P08** 36
 7,5x30,6 cm 3"x12"



elemento "L" monolitico outdoor **P50** 4
 15x30x4 cm 6"x12" 3/4"



Formati 30,6x30,6 e 15,1x30,6 prodotti con bordi irregolari e angoli arrotondati.
 30,6x30,6 and 15,1x30,6 sizes produced with uneven edges and rounded corners.
 Formats 30,6x30,6 et 15,1x30,6 produits avec bords irréguliers et angles arrondis.
 Format 30,6x30,6 und 15,1x30,6, mit unregelmäßigen Kanten und abgerundeten Ecken.

Materiale non esattamente calibrato; prevedere fuga di 5 mm.
 Calibration of this product is not exact; please consider a 5 mm joint.
 Matériel non calibré de manière précise; prévoir un joint de 5 mm.
 Nicht exakt rektifiziertes Material, es muss eine Fuge von 5 mm vorgesehen werden.

Note - Notes - Notes - Anmerkungen
 I battiscopa e gli elementi "L" vengono venduti a pz. e a scatola completa. - All skirting and monolithic L elements, priced per piece, are sold in full box.
 Les plinthes et élément "L" sont vendues la pièce et par boîte complète. - Die Sockelleisten und Stufen werden pro Stk. und Vollen Kartons verkauft.

effetto marmo - marble-look - effet marbre - marmoroptik



<u>athena</u>	<u>132</u>
<u>endless</u>	<u>122</u>
<u>endless FP2</u>	<u>126</u>
<u>luxory</u>	<u>128</u>
<u>white marble</u>	<u>118</u>



IL CAVALLINO
CERAMICHE since 1968

WHITE MARBLE

effetto marmo
marble-look
effet marbre
marmoroptik

grès porcellanato
porcelain stoneware . grès cérame . feinsteinzeug



Formati Sizes - Formats - Formate

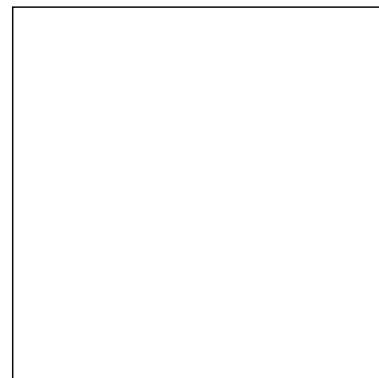

122,6x122,6 cm R / 48"x48" R
122,6x122,6 cm LR / 48"x48" LR

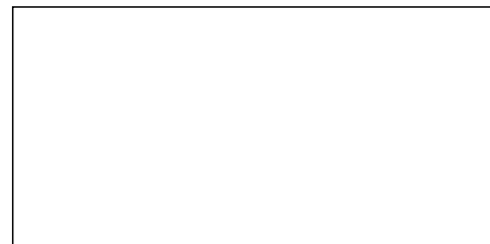

80,0x160,0 cm R / 31"x62" R
80,0x160,0 cm LR / 31"x62" LR



61,3x122,6 cm R / 24"x48" R
60,0x121,0 cm LR / 24"x48" LR

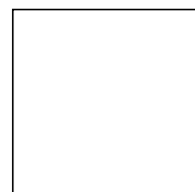

61,0x61,0 cm R / 24"x24" R



30,4x61,0 cm R / 12"x24" R

Colori Colours - Couleurs - Farbe



CALACATTA ORO



STATUARIO



Avvertenze: i formati rettificati non sono modulari in nessun formato con i formati lappati.
Note: the rectified formats cannot be combined with the lapped formats.
Avertissement: les formats rectifiés ne sont modulaires en aucun format avec les formats polis.
Hinweis: Gleichgerichtete Formate sind in keinem Format mit geläpften Formaten modular.

Calacatta Oro
122,6x122,6 cm . 48"x48" LR

WHITE MARBLE



calacatta oro

122,6x122,6 cm 48"x48"	R	A230
122,6x122,6 cm 48"x48"	LR	A231
80,0x160,0 cm 31"x62"	R	A210
80,0x160,0 cm 31"x62"	LR	A211
61,3x122,6 cm 24"x48"	R	A180
60,0x121,0 cm 24"x48"	LR	A183
61,0x61,0 cm 24"x24"	R	A192
30,4x61,0 cm 12"x24"	R	A110

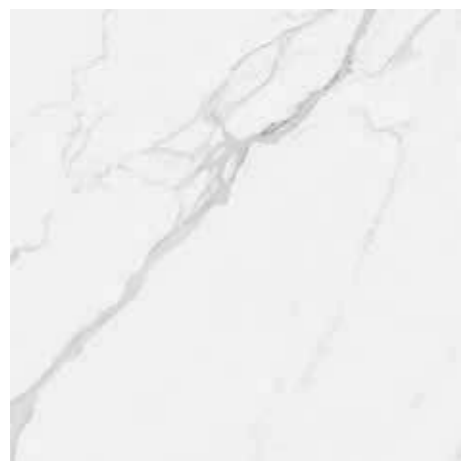

statuario

122,6x122,6 cm 48"x48"	R	A230
122,6x122,6 cm 48"x48"	LR	A231
80,0x160,0 cm 31"x62"	R	A210
80,0x160,0 cm 31"x62"	LR	A211
61,3x122,6 cm 24"x48"	R	A180
60,0x121,0 cm 24"x48"	LR	A183
61,0x61,0 cm 24"x24"	R	A192
30,4x61,0 cm 12"x24"	R	A110

sviluppo grafico - design development - développement graphique -
grafische entwicklung 122,6x122,6 cm . 48"x48" LR
(6 grafiche diverse - 6 different design - 6 graphiques différents - verschiedene Grafische)



sviluppo grafico - design development - développement graphique -
grafische entwicklung 122,6x122,6 cm . 48"x48" LR
(6 grafiche diverse - 6 different design - 6 graphiques différents - verschiedene Grafische)

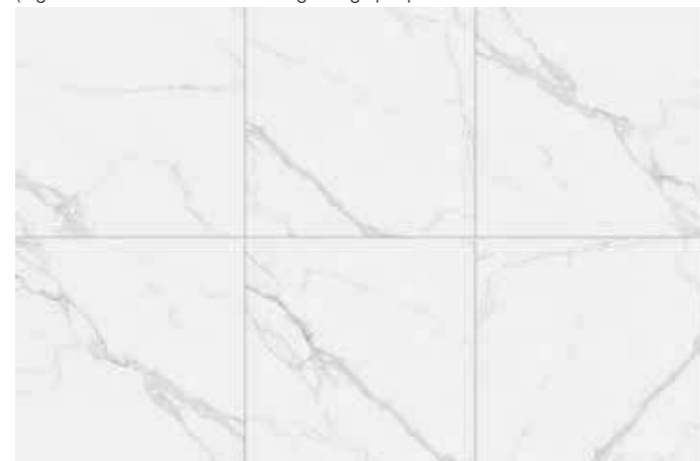

WHITE MARBLE

decori - decors - décors - dekors

mosaico esagona - 30x30 cm 12"x12" N L 7 N P78 L P79



calacatta oro



statuario

mosaico monocolore 36 tessere 5x5 - 30x30 cm 12"x12" N L 7 N P71 L P72



calacatta oro



statuario

pezzi speciali - special pieces - pièces spéciales - fornteile

battiscopa
6,5x61,0 cm 2 1/2"x24" R P07 12
6,5x121,0 cm 2 1/2"x48" LR P04 10



calacatta oro

statuario

step
30,4x61,0 cm 12"x24" R P90

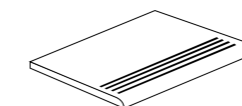

calacatta oro

statuario

gradino costa retta
34x122,6x4 cm 13"x48"x1 3/4" R P32
34x61,0x4 cm 13"x24"x1 3/4" R P31

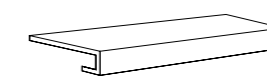

calacatta oro

statuario

angolare costa retta dx/sx
34x122,6x4 cm 13"x48"x1 3/4" R P41
34x34x4 cm 13"x13"x1 3/4" R P40

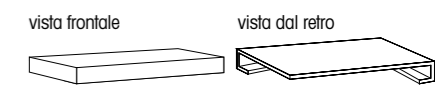

calacatta oro

statuario

Avvertenze: i formati rettificati non sono modulari in nessun formato con i formati lappati.
Note: the rectified formats cannot be combined with the lapped formats.
Avertissement: les formats rectifiés ne sont modulaires en aucun format avec les formats polis.
Hinweis: Gleichgerichtete Formate sind in keinem Format mit geläpften Formaten modular.

Note - Notes - Notes - Anmerkungen
I battiscopa vengono venduti a pz. e a scatola completa. Tutti gli altri pezzi speciali vengono venduti al pezzo. I gradini vengono prodotti solo su ordinazione (tempo minimo di consegna 20 gg lavorativi).
All skirting priced per piece, are sold in full box. All other special trims are sold by piece. Steps are produced only on request (minimum delivery terms of 20 days).
Les plinthes sont vendues la pièce et par boîte complète. Les autres pièces spéciales sont vendus la pièce. Le plot de marche sont produit sur demande (délai minimum de 20 jours).
Die Sockelleisten werden pro Stk. und Vollen Kartons verkauft. Stufen und Stufenecken werden nur auf Bestellung produziert (Lieferzeiten mindesten 20 arbeitstagen ab Auftragserteilung).

ENDLESS

grès porcellanato
 orcelain stoneware . grès cérame . feinsteinzeug

effetto marmo
 marble-look
 effet marbre
 marmoroptik



Formati Sizes - Formats - Formate

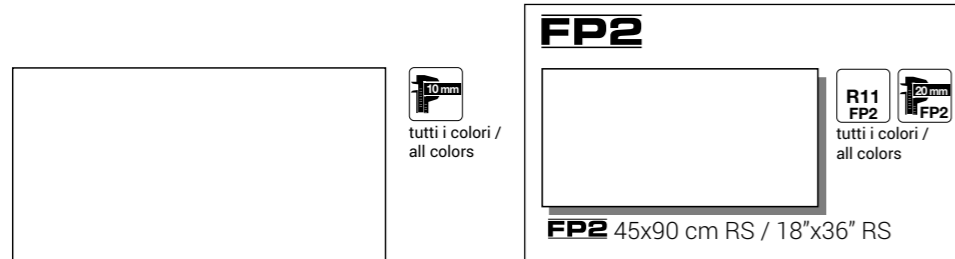

122,6x122,6 cm LR / 48"x48" LR



80,0x160,0 cm LR / 31"x62" LR

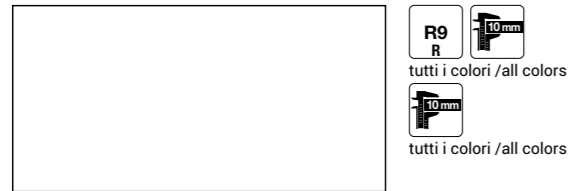

61,3x122,6 cm R / 24"x48" R
 60,0x121,0 cm LR / 24"x48" LR

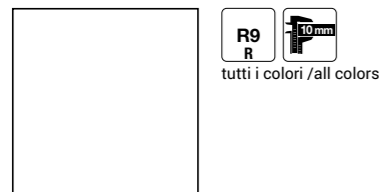

61,0x61,0 cm R / 24"x24" R

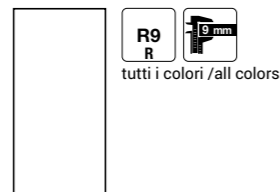

30,4x61,0 cm R / 12"x24" R

Colori Colours - Couleurs - Farbe



Avvertenze: i formati rettificati non sono modulari in nessun formato con i formati lappati.
 Note: the rectified formats cannot be combined with the lapped formats.
 Avertissement : les formats rectifiés ne sont modulaires en aucun format avec les formats polis.
 Hinweis: Gleichgerichtete Formate sind in keinem Format mit geläpften Formaten modular.



floor: 122,6x122,6 cm . 48"x48" LR - wall: 60,0x121,0 cm . 24"x48" LR Silver

ENDLESS



white

122,6x122,6 cm 48"x48"	LR	A231
80,0x160,0 cm 31"x62"	LR	A211
61,3x122,6 cm 24"x48"	R	A180
60,0x121,0 cm 24"x48"	LR	A183
61,0x61,0 cm 24"x24"	R	A192
30,4x61,0 cm 12"x24"	R	A110

FP2

45x90 cm 18"x36" FP2	RS	A171
----------------------	----	------



silver

122,6x122,6 cm 48"x48"	LR	A231
80,0x160,0 cm 31"x62"	LR	A211
61,3x122,6 cm 24"x48"	R	A180
60,0x121,0 cm 24"x48"	LR	A183
61,0x61,0 cm 24"x24"	R	A192
30,4x61,0 cm 12"x24"	R	A110

FP2

45x90 cm 18"x36" FP2	RS	A171
----------------------	----	------



bone

122,6x122,6 cm 48"x48"	LR	A231
80,0x160,0 cm 31"x62"	LR	A211
61,3x122,6 cm 24"x48"	R	A180
60,0x121,0 cm 24"x48"	LR	A183
61,0x61,0 cm 24"x24"	R	A192
30,4x61,0 cm 12"x24"	R	A110

FP2

45x90 cm 18"x36" FP2	RS	A171
----------------------	----	------

Bone floor: 122,6x122,6 cm . 48"x48" LR - wall: 61,0x61,0 cm . 24"x24" R



Avvertenze: i formati rettificati non sono modulari in nessun formato con i formati lappati.
 Note: the rectified formats cannot be combined with the lapped formats.
 Avertissement: les formats rectifiés ne sont modulaires en aucun format avec les formats polis.
 Hinweis: Gleichgerichtete Formate sind in keinem Format mit geläpften Formaten modular.

ENDLESS

decori - decors - décors - dekors

mosaico esagona - 30x30 cm 12"x12" N P78 7



white silver bone

mosaico monocolore N 36 tessere 5x5 - 30x30 cm 12"x12" N P71 7



white silver bone

mosaico monocolore mix N/L 81 tessere 3x3 - 30x30 cm 12"x12" N/L MIX P74 7

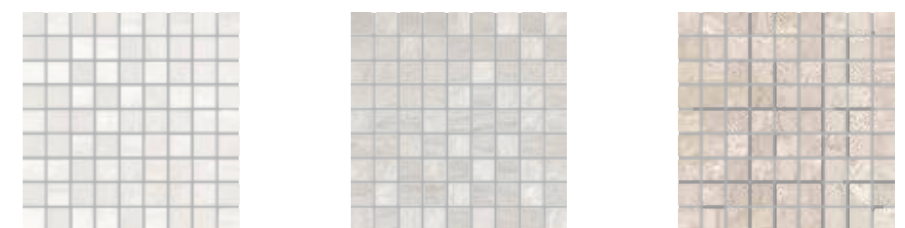

white silver bone

pezzi speciali - special pieces - pièces spéciales - formteile

step
 30,4x61,0 cm 12"x24" R P90

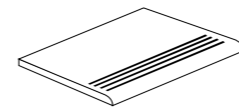

white
 silver
 bone

gradino costa retta
 34x122,6x4 cm 13"x48"x1^{3/4}" R P32
 34x61,0x4 cm 13"x24"x1^{3/4}" R P31

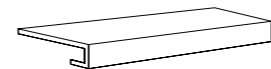

white
 silver
 bone

angolare costa retta dx/sx
 34x122,6x4 cm 13"x48"x1^{3/4}" R P41
 34x34x4 cm 13"x13"x1^{3/4}" R P40

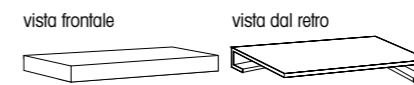

white
 silver
 bone

battiscopa
 6,5x61,0 cm 2^{1/2}"x24" R P07 12
 6,5x121,0 cm 2^{1/2}"x48" LR P04 10



white

silver

bone

Note - Notes - Notes - Anmerkungen
 I battiscopa vengono venduti a pz. e a scatola completa. Tutti gli altri pezzi speciali vengono venduti al pezzo. I gradini vengono prodotti solo su ordinazione (tempo minimo di consegna 20 gg lavorativi).
 Skirlings are sold by piece and full boxes. All other special trims are sold by piece. Steps are produced only on request (minimum delivery terms of 20 days).
 Les plinthes sont vendues la pièce et par boîte complète. Les autres pièces spéciales sont vendues la pièce. Le plat de marche sont produit sur demande (délai minimum de 20 jours).
 Die Sockelleisten werden pro Stk. und Vollen Kartons verkauft. Stufen und Stufenecken werden nur auf Bestellung produziert (Lieferzeiten mindesten 20 arbeitstagen ab Auftragserteilung).

ENDLESS **FP2**

technical project
FP2
outdoor



white

45x90 cm 18"x36" **FP2**

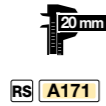

silver

45x90 cm 18"x36" **FP2**

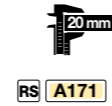

bone

45x90 cm 18"x36" **FP2**

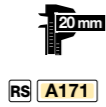

FP2 pezzi speciali - special pieces - pièces spéciales - formteile

elemento "L"
45x90x5 cm 18"x36"x2" **RS P101**



white
silver
bone

angolare elemento "L"
45x90x5 cm 18"x36"x2" **RS P104**



white
silver
bone

griglia
20x90 cm 8"x36" **RS P118**

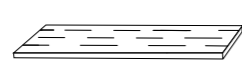

white
silver
bone

griglia angolo
20x90 cm 8"x36" **RS P108 COPPIA**



white
silver
bone

angolo SX angolo DX

round lineare
45x90 cm 18"x36" **RS P111**

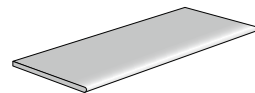

white
silver
bone

round angolare
45x90 cm 18"x36" **RS P120 COPPIA**

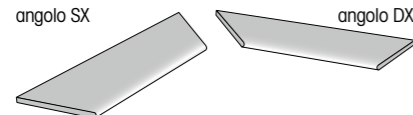

white
silver
bone

angolo SX angolo DX

angolo bordo toro
45x90 cm 18"x36" **RS P115**

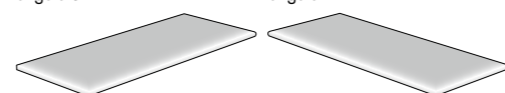

white
silver
bone

angolo SX angolo DX

Note - Notes - Notes - Anmerkungen

I pezzi speciali FP2 vengono venduti al pezzo e solo su ordinazione (tempo minimo di consegna 20 gg lavorativi dall'ordine)

The special pieces FP2 are sold by piece and only on request (minimum delivery time 20 working days from date of order).

Les pièces spéciales FP2 sont vendus à la pièce et uniquement sur commande (délai minimum de livraison 20 jours ouvrés à partir de la commande).

Spezial Teile FP2 sind pro Stück verkauft und nur auf Bestellungen produziert. (Lieferzeiten mindesten 20 arbeitstage ab Auftragbestätigung)

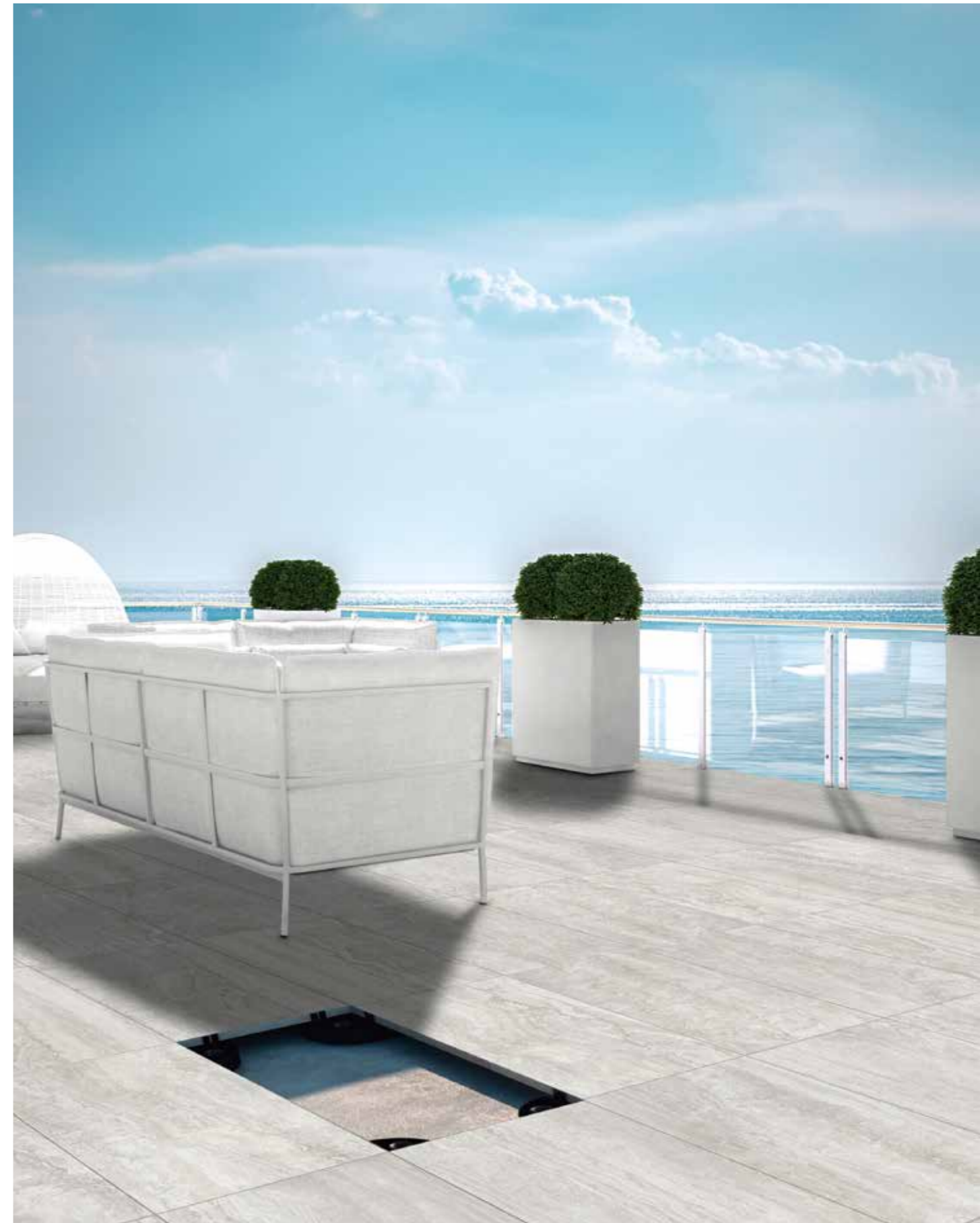

FP2 Silver
45x90 cm . 18"x36" RS

LUXORY

grès porcellanato
porcelain stoneware . grès cérame . feinsteinzeug

Formati
Sizes - Formats - Formate

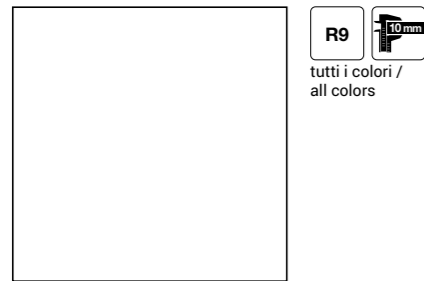

90x90 cm LUX-R / 36"x36" LUX-R

LUX-R LUX/RETTIFICATO
LUX/RECTIFIED

effetto marmo
marble-look
effet marbre
marmoroptik



Colori
Colours - Couleurs - Farbe

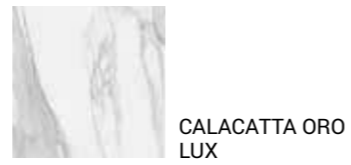

CALACATTA ORO
LUX

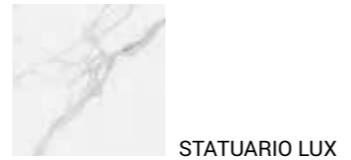

STATUARIO LUX



ENDLESS WHITE
LUX



ENDLESS SILVER
LUX



ENDLESS BONE
LUX



floor: Statuario 90x90 cm . 36"x36" LUX-R
wall: Statuario 60,0x121,0 cm . 24"x48" LR

LUXORY



endless white lux

90x90 cm 36"x36"

LUX-R A223



endless silver lux

90x90 cm 36"x36"

LUX-R A223

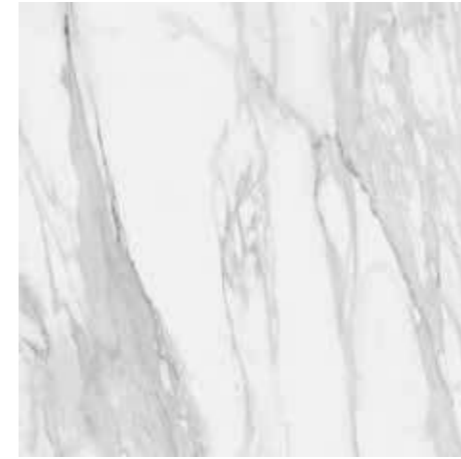

calacatta oro lux

90x90 cm 36"x36"

LUX-R A223



statuario lux

90x90 cm 36"x36"

LUX-R A223



endless bone lux

90x90 cm 36"x36"

LUX-R A223

Bone 90x90 cm . 36"x36" LUX-R



pezzi speciali - special pieces - pièces spéciales - formteile

battiscopa
6,5x90,0 cm 2 1/2"x36" LUX-R P03 10



statuario lux

Note - Notes - Notes - Anmerkungen
I battiscopa vengono venduti a pz. e a scatola completa. / Il skirting, priced per piece, are sold in full box.
Les plinthes sont vendues la pièce et par boîte complete. / Die Sockelleisten werden pro Stk. und Vollen Kartons verkauft.

ATHENA

effetto marmo
marble-look
effet marbre
marmoroptik

grès porcellanato impasto colorato
color body porcelain stoneware . grès cérame coloré dans la masse . durchgefärbtes feinsteinzeug



Formati Sizes - Formats - Formate

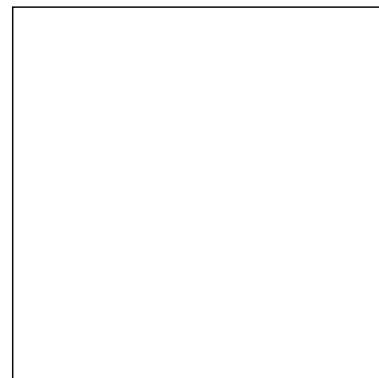

tutti i colori / all colors

122,6x122,6 cm LR / 48"x48" LR

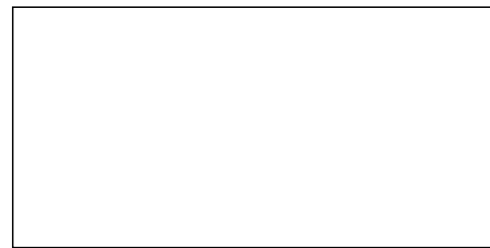

bianco, nero

80,0x160,0 cm LR / 31"x62" LR



tutti i colori / all colors

60,0x121,0 cm LR / 24"x48" LR



tutti i colori / all colors

61,0x61,0 cm R / 24"x24" R

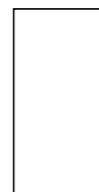

tutti i colori / all colors

30,4x61,0 cm R / 12"x24" R

Colori Colours - Couleurs - Farbe



BIANCO



GRIGIO

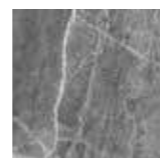

NERO



ALMOND



R RETTIFICATO
RECTIFIED

LR LAPPATO/RETTIFICATO
LAPPED/RECTIFIED

Avvertenze: i formati rettificati non sono modulari in nessun formato con i formati lappati.
Note: the rectified formats cannot be combined with the lapped formats.
Avertissement: les formats rectifiés ne sont modulaires en aucun format avec les formats polis.
Hinweis: Gleichgerichtete Formate sind in keinem Format mit geläpften Formaten modular.

Nero
60,0x121,0 cm . 24"x48" LR

ATHENA

ATHENA

decori - decors - décors - dekors



bianco

122,6x122,6 cm 48"x48"	LR A231
80,0x160,0 cm 31"x62"	LR A211
60,0x121,0 cm 24"x48"	LR A183
61,0x61,0 cm 24"x24"	R A192
30,4x61,0 cm 12"x24"	R A110



grigio

122,6x122,6 cm 48"x48"	LR A231
60,0x121,0 cm 24"x48"	LR A183
61,0x61,0 cm 24"x24"	R A192
30,4x61,0 cm 12"x24"	R A110



nero

122,6x122,6 cm 48"x48"	LR A231
80,0x160,0 cm 31"x62"	LR A211
60,0x121,0 cm 24"x48"	LR A183
61,0x61,0 cm 24"x24"	R A192
30,4x61,0 cm 12"x24"	R A110



almond

122,6x122,6 cm 48"x48"	LR A231
60,0x121,0 cm 24"x48"	LR A183
61,0x61,0 cm 24"x24"	R A192
30,4x61,0 cm 12"x24"	R A110



bianco



grigio

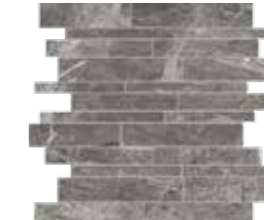

nero



almond

patchwork - 30x30 cm 12"x12" N P80 7



bianco



grigio

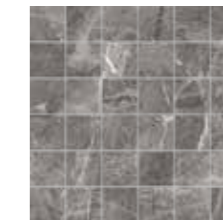

nero



almond

mosaico monocolore 36 tessere 5x5 - 30x30 cm 12"x12" N P71 7



bianco



grigio

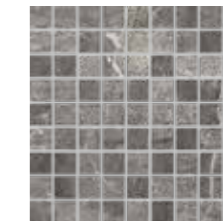

nero



almond

mosaico monocolore mix N/L 81 tessere 3x3 - 30x30 cm 12"x12" N/L MIX P74 7

step
30,4x61,0 cm 12"x24" R P90

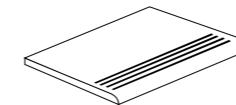

- almond
- bianco
- grigio
- nero

gradino costa retta
34x61,0x4 cm 13"x24"x1^{3/4}" R P31

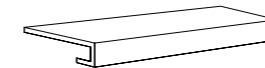

- almond
- bianco
- grigio
- nero

angolare costa retta dx/sx
34x34x4 cm 13"x13"x1^{3/4}" R P40

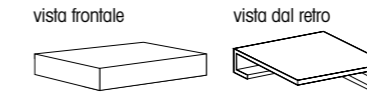

- almond
- bianco
- grigio
- nero

battiscopa
6,5x61,0 cm 2^{1/2}"x24" R P07 12
6,5x121,0 cm 2^{1/2}"x48" LR P04 10



Avvertenze: i formati rettificati non sono modulari in nessun formato con i formati lappati.
Note: the rectified formats cannot be combined with the lapped formats.
Avertissement: les formats rectifiés ne sont modulaires en aucun format avec les formats polis.
Hinweis: Gleichgerichtete Formate sind in keinem Format mit geläpften Formaten modular.

Note - Notes - Notes - Anmerkungen
I battiscopa vengono venduti a pz. e a scatola completa. Tutti gli altri pezzi speciali vengono venduti al pezzo. I gradini vengono prodotti solo su ordinazione (tempo minimo di consegna 20 gg lavorativi).
Skirtings are sold by piece and full boxes. All other special pieces are sold by piece. Steps are produced only on request (minimum delivery terms of 20 days).
Les plinthes sont vendues la pièce et par boîte complète. Les autres pièces spéciales sont vendues la pièce. Le plat de marche sont produit sur demande (délai minimum de 20 jours).
Die Sockelleisten werden pro Stk. und Vollen Kartons verkauft. Stufen und Stufenecken werden nur auf Bestellung produziert (Lieferzeiten mindesten 20 arbeitstagen ab Auftragserteilung).

effetto legno - wood-look - effet bois - holzoptik



chalet	168
decapé floor	142
decapé wall	147
decapé FP2	148
fjord	150
fjord FP2	154
intarsio	164
north wind floor	156
north wind wall	161
north wind FP2	162
river	138



IL CAVALLINO
CERAMICHE since 1968

RIVER

grès porcellanato
porcelain stoneware . grès cérame . feinsteinzeug

effetto legno
wood-look
effet bois
holzoptik



Formati
Sizes - Formats - Formate

Colori
Colours - Couleurs - Farbe



26,0x160,0 cm R / 10"x62" R



WHITE



SMOKE



BROWN

R RETTIFICATO
RECTIFIED



White
26,0x160,0 cm . 10"x62" R



Brown
26,0x160,0 cm . 10"x62" R

RIVER



white

26,0x160,0 cm 10"x62"

R A90



smoke

26,0x160,0 cm 10"x62"

R A90



brown

26,0x160,0 cm 10"x62"

R A90

pezzi speciali - special pieces - pièces spéciales - formteile

battiscopa
6,5x160,0 cm 2 1/2"x62" **R P06**  6



white

smoke

brown

Note - Notes - Notes - Anmerkungen
I battiscopa vengono venduti a pz. e a scatola completa. Skirtings are sold by piece and full boxes.
Les plinthes sont vendues la pièce et par boîte complète. Die Sockelleisten werden pro Stk. und Vollen Kartons verkauft.

RIVER

sviluppo grafico - design development - développement graphique - grafische entwicklung 26,0x160,0 cm . 10"x62" R
(15 grafiche diverse . 15 different design . 15 graphiques différents . 15 verschiedene Grafische)



white



smoke



brown

DECAPÉ

effetto legno
wood-look
effet bois
holzoptik

grès porcellanato
porcelain stoneware . grès cérame . feinsteinzeug

Formati
Sizes - Formats - Formate

Colori
Colours - Couleurs - Farbe



R10 **10mm**
grigio, bianco, miele, noce

26,0x160,0 cm R / 10"x62" R

R10 **10mm**
tutti i colori / all colors

30,5x122,6 cm R / 12"x48" R

R10 **10mm**
tutti i colori / all colors

20,3x122,6 cm R / 8"x48" R
20,3x122,6 cm R - outdoor/
8"x48" R - outdoor

R11 outdoor **10mm**
grigio, miele, noce

R10 **10mm**
tutti i colori / all colors

22x90 cm R / 9"x36" R

R10 **10mm**
tutti i colori / all colors

15x90 cm R / 6"x36" R
15x90 cm R - outdoor/
6"x36" R - outdoor

R11 outdoor **10mm**
grigio, miele, noce

R10 **9mm**
tutti i colori / all colors

15x61 cm R / 6"x24" R

R RETTIFICATO
RECTIFIED **RS** RETTIFICATO/STRUTTURATO
RECTIFIED/TEXTURED **N** NATURALE
NATURAL

FP2

FP2 40x122 cm RS / 16"x48" RS

R11 FP2 **20mm**
miele, noce

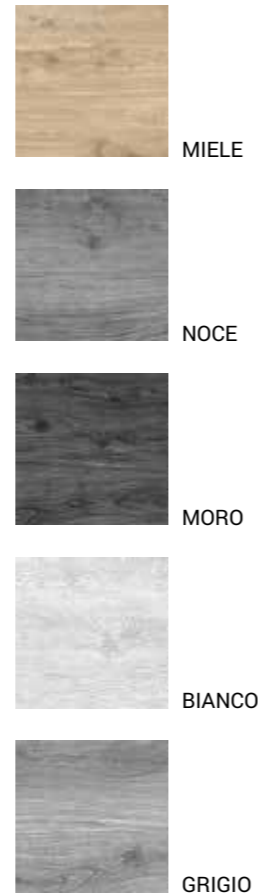

rivestimento coordinato - matching wall tiles - faïences coordonnées - koordinierte wandfliesen:

Decapé 25x60 cm . 10"x24" - **8mm**

bicottura tradizionale
traditional double fired - traditionnelle double feue - zweibrandfliesen

Formati
Sizes - Formats - Formate

Colori
Colours - Couleurs - Farbe

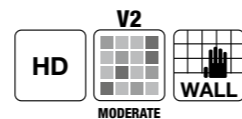

8mm **N**
tutti i colori / all colors

25x60 cm / 10"x24"

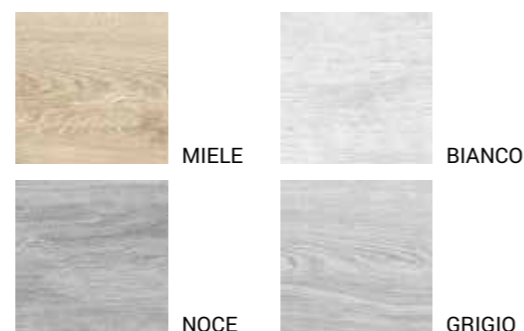

Miele
20,3x122,6 cm . 8"x48" R

DECAPÉ



miele

26,0x160,0 cm 10"x62"	R A90
30,5x122,6 cm 12"x48"	R A120
20,3x122,6 cm 8"x48"	R A30
20,3x122,6 cm 8"x48" OUTDOOR	R A31
22x90 cm 9"x36"	R A70
15x90 cm 6"x36"	R A20
15x90 cm 6"x36" OUTDOOR	R A21
15x61 cm 6"x24"	R A10

FP2

40x122 cm 16"x48" FP2	RS A150
------------------------------	-----------------------



noce

26,0x160,0 cm 10"x62"	R A90
30,5x122,6 cm 12"x48"	R A120
20,3x122,6 cm 8"x48"	R A30
20,3x122,6 cm 8"x48" OUTDOOR	R A31
22x90 cm 9"x36"	R A70
15x90 cm 6"x36"	R A20
15x90 cm 6"x36" OUTDOOR	R A21
15x61 cm 6"x24"	R A10

FP2

40x122 cm 16"x48" FP2	RS A150
------------------------------	-----------------------



moro

30,5x122,6 cm 12"x48"	R A120
20,3x122,6 cm 8"x48"	R A30
22x90 cm 9"x36"	R A70
15x90 cm 6"x36"	R A20
15x61 cm 6"x24"	R A10

DECAPÉ

sviluppo grafico - design development - développement graphique - grafische entwicklung 20,3x122,6 cm . 8"x48" R
(18 grafiche diverse . 18 different design . 18 graphiques différents . 18 verschiedene Grafische)



bianco



grigio



miele



noce



moro

DECAPÉ

pezzi speciali - special pieces - pièces spéciales - formteile

battiscopa
6,5x122,6 cm 2 1/2"x48" **R** **P05**  10



miele
noce
moro
bianco
grigio

elemento "L" monolitico outdoor **P51**  2
15x61x4 cm 6"x24"x1 3/4"



miele

noce

grigio

step
30,4x61,0 cm 12"x24" **R** **P90**

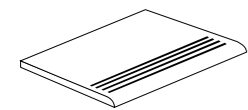

miele
noce
moro
bianco
grigio

gradino costa retta
34x122,6x4 cm 13"x48"x1 3/4" **R** **P32**

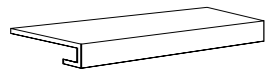

miele
noce
moro
bianco
grigio

angolare costa retta dx/sx
34x122,6x4 cm 13"x48"x1 3/4" **R** **P41**

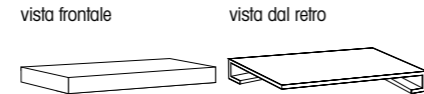

miele
noce
moro
bianco
grigio

Note - Notes - Notes - Anmerkungen
I battiscopa e gli elementi "L" vengono venduti a pz. e a scatola completa. Tutti gli altri pezzi speciali vengono venduti al pezzo. I gradini vengono prodotti solo su ordinazione (tempo minimo di consegna 20 gg lavorativi).
All skirting and monolithic L elements, priced per piece, are sold in full box. All other special trims are sold by piece. Steps are produced only on request (minimum delivery terms of 20 days).
Les plinthes et élément "L" sont vendues la pièce et par boîte complète. Les autres pièces spéciales sont vendus la pièce. Le plat de marche sont produit sur demande (délai minimum de 20 jours).
Die Sockelleisten und Stufen werden pro Stk. und Vollen Kartons verkauft. Stufen und Stufenecken werden nur auf Bestellung produziert (Lieferzeiten mindesten 20 arbeitstagen ab Auftragserteilung).

DECAPÉ wall

bicottura tradizionale
traditional double fired - traditionnelle double feue - zweibrandfliesen
rivestimento coordinato - matching wall tiles - faiences coordonnes - koordinierte wandfliesen



miele
25x60 cm 10"x24" **N** **A80**



bianco
25x60 cm 10"x24" **N** **A80**



noce
25x60 cm 10"x24" **N** **A80**



grigio
25x60 cm 10"x24" **N** **A80**

decori - decors - décors - dekors



mosaico mix warm
25x60 cm 10"x24"  **N** **A81**

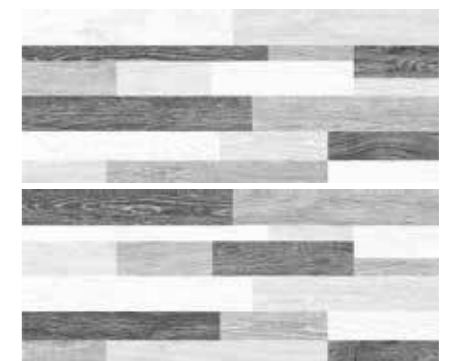

mosaico mix cold
25x60 cm 10"x24"  **N** **A81**

DECAPÉ **FP2**

technical project
FP2
outdoor



miele

40x122 cm 16"x48" **FP2**

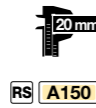

noce

40x122 cm 16"x48" **FP2**

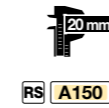

FP2 pezzi speciali - special pieces - pièces spéciales - formteile

*Griglia e griglia angolo 20x61 cm abbinare al formato 40x122 cm.
Grille and corner grille 8"x24" combined with the 16"x48" size.

elemento "L"
40x122x5 cm 16"x48"x2" **RS P102**

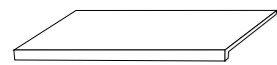

miele

noce

angolare elemento "L"
40x122x5 cm 16"x48"x2" **RS P105**

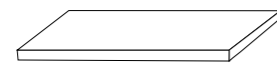

miele

noce

griglia
*20x61,0 cm 8"x24" **RS P106**

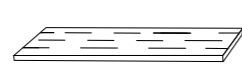

miele

noce

griglia angolo
*20x61,0 cm 8"x24" **RS P109 COPPIA**



miele

noce

round lineare
40x122 cm 16"x48" **RS P112**

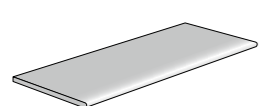

miele

noce

round angolare
40x122 cm 16"x48" **RS P113 COPPIA**

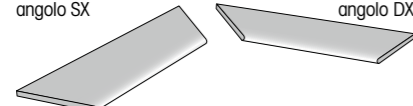

miele

noce

angolo bordo toro
40x122 cm 16"x48" **RS P116**

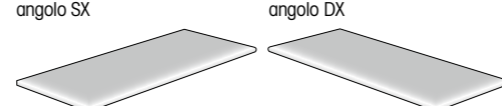

miele

noce

Note - Notes - Notes - Anmerkungen

I pezzi speciali FP2 vengono venduti al pezzo e solo su ordinazione (tempo minimo di consegna 20 gg lavorativi dall'ordine)

The special pieces FP2 are sold by piece and only on request (minimum delivery time 20 working days from date of order).

Les pièces spéciales FP2 sont vendus à la pièce et uniquement sur commande (délai minimum de livraison 20 jours ouvrés à partir de la commande).

Spezial Teile FP2 sind pro Stück verkauft und nur auf Bestellungen produziert. (Lieferzeiten mindesten 20 arbeitstage ab Auftragbestätigung)



FP2 Noce
40x122 cm . 16"x48" RS

FJORD

grès porcellanato
porcelain stoneware . grès cérame . feinsteinzeug

Formati
Sizes - Formats - Formate

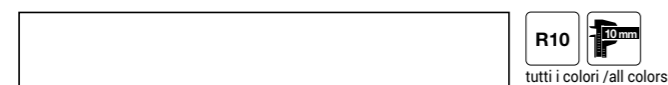

26,0x160,0 cm R / 10"x62" R

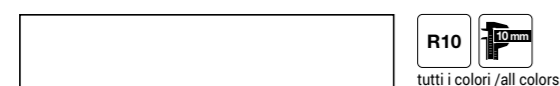

30,5x122,6 cm R / 12"x48" R

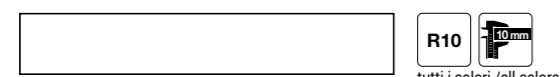

20,3x122,6 cm R / 8"x48" R
20,3x122,6 cm R - outdoor/
8"x48" R - outdoor

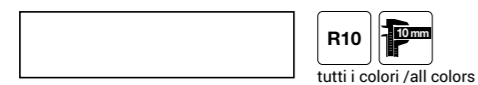

22x90 cm R / 9"x36" R

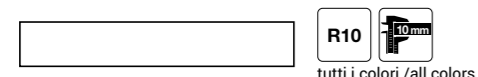

15x90 cm R / 6"x36" R



15x61 cm R / 6"x24" R

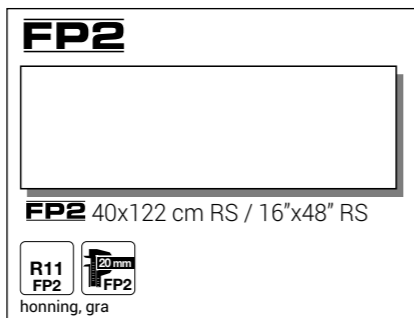

FP2 40x122 cm RS / 16"x48" RS



R11 FP2

FP2

honning, gra

effetto legno
wood-look
effet bois
holzoptik



Colori
Colours - Couleurs - Farbe

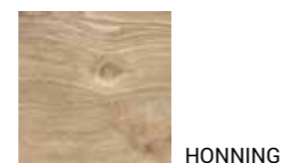

HONNING



BRUN



VIT

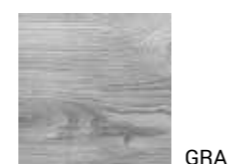

GRA



Honning 30,5x122,6 cm . 12"x48" R - 20,3x122,6 cm . 8"x48" R - 20,3x122,6 cm R . 8"x48" R outdoor
elemento "L" monolitico outdoor 15x61x4 cm . 6"x24"x13/4"

R RETTIFICATO
RECTIFIED **RS** RETTIFICATO/STRUTTURATO
RECTIFIED/TEXTURED

FJORD



honning

26,0x160,0 cm 10"x62"	R A90
30,5x122,6 cm 12"x48"	R A120
20,3x122,6 cm 8"x48"	R A30
20,3x122,6 cm 8"x48" OUTDOOR	R A31
22x90 cm 9"x36"	R A70
15x90 cm 6"x36"	R A20
15x61 cm 6"x24"	R A10

FP2

40x122 cm 16"x48" FP2	RS A150
------------------------------	-----------------------



brun

26,0x160,0 cm 10"x62"	R A90
30,5x122,6 cm 12"x48"	R A120
20,3x122,6 cm 8"x48"	R A30
22x90 cm 9"x36"	R A70
15x90 cm 6"x36"	R A20



vit

26,0x160,0 cm 10"x62"	R A90
30,5x122,6 cm 12"x48"	R A120
20,3x122,6 cm 8"x48"	R A30
22x90 cm 9"x36"	R A70
15x90 cm 6"x36"	R A20
15x61 cm 6"x24"	R A10



gra

26,0x160,0 cm 10"x62"	R A90
30,5x122,6 cm 12"x48"	R A120
20,3x122,6 cm 8"x48"	R A30
20,3x122,6 cm 8"x48" OUTDOOR	R A31
22x90 cm 9"x36"	R A70
15x90 cm 6"x36"	R A20
15x61 cm 6"x24"	R A10

FP2

40x122 cm 16"x48" FP2	RS A150
------------------------------	-----------------------

FJORD

decori - decors - décors - dekors

inserto sticky 3D - 18,5x59,4 cm 7^{1/2}"x24" **P84** **4**



mosaico norge 36x32,5 cm 14^{1/2}"x13" **P85** **7**

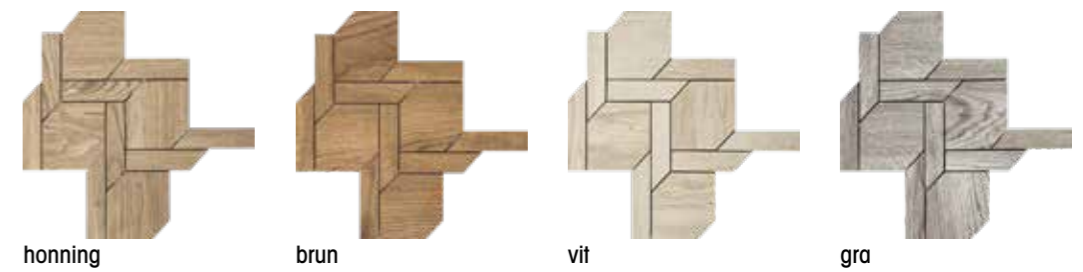

pezzi speciali - special pieces - pièces spéciales - formteile

elemento "L" monolitico outdoor **P51** **2**
15x61x4 cm 6"x24"x1^{3/4}"



battiscopa
6,5x122,6 cm 2^{1/2}"x48" **R** **P05** **10**



gradino costa retta
34x122,6x4 cm 13"x48"x1^{3/4}" **R** **P32**

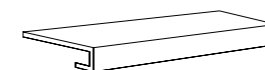

honning
brun
vit
gra

angolare costa retta dx/sx
34x122,6x4 cm 13"x48"x1^{3/4}" **R** **P41**
vista frontale vista dal retro

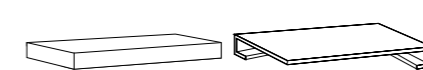

honning
brun
vit
gra

Note - Notes - Notes - Anmerkungen
I battiscopa e gli elementi "L" vengono venduti a pz. e a scatola completa. Tutti gli altri pezzi speciali vengono venduti al pezzo. I gradini vengono prodotti solo su ordinazione (tempo minimo di consegna 20 gg lavorativi).
All skirting and monolithic L elements, priced per piece, are sold in full box. All other special trims are sold by piece. Steps are produced only on request (minimum delivery terms of 20 days).
Les plinthes et élément "L" sont vendues la pièce et par boîte complète. Les autres pièces spéciales sont vendus la pièce. Le plat de marche sont produit sur demande (délai minimum de 20 jours).
Die Sockelleisten und Stufen werden pro Stk. und Vollen Kartons verkauft. Stufen und Stufenecken werden nur auf Bestellung produziert (Lieferzeiten mindesten 20 arbeitstagen ab Auftragserteilung).

FJORD **FP2**

technical project
FP2
outdoor



honing

40x122 cm 16"x48" **FP2**



RS **A150**



gra

40x122 cm 16"x48" **FP2**



RS **A150**

FP2 pezzi speciali - special pieces - pièces spéciales - formteile

*Griglia e griglia angolo 20x61 cm abbinare al formato 40x122 cm.
Grille and corner grille 8"x24" combined with the 16"x48" size.

elemento "L"
40x122x5 cm 16"x48"x2" **RS P102**

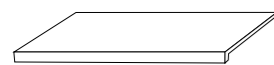

honing
gra

angolare elemento "L"
40x122x5 cm 16"x48"x2" **RS P105**

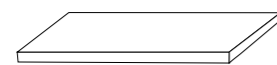

honing
gra

griglia
*20x61,0 cm 8"x24" **RS P106**

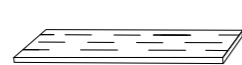

honing
gra

griglia angolo
*20x61,0 cm 8"x24" **RS P109 COPPIA**

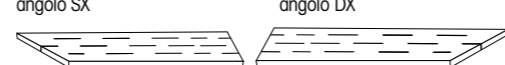

honing
gra

round lineare
40x122 cm 16"x48" **RS P112**

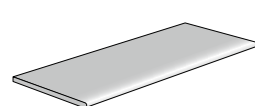

honing
gra

round angolare
40x122 cm 16"x48" **RS P113 COPPIA**

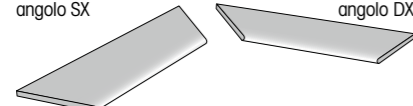

honing
gra

angolo bordo toro
40x122 cm 16"x48" **RS P116**

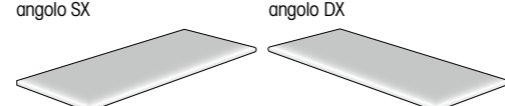

honing
gra

Note - Notes - Notes - Anmerkungen

I pezzi speciali FP2 vengono venduti al pezzo e solo su ordinazione (tempo minimo di consegna 20 gg lavorativi dall'ordine)

The special pieces FP2 are sold by piece and only on request (minimum delivery time 20 working days from date of order).

Les pièces spéciales FP2 sont vendus à la pièce et uniquement sur commande (délai minimum de livraison 20 jours ouvrés à partir de la commande).

Spezial Teile FP2 sind pro Stück verkauft und nur auf Bestellungen produziert. (Lieferzeiten mindesten 20 arbeitstage ab Auftragbestätigung)

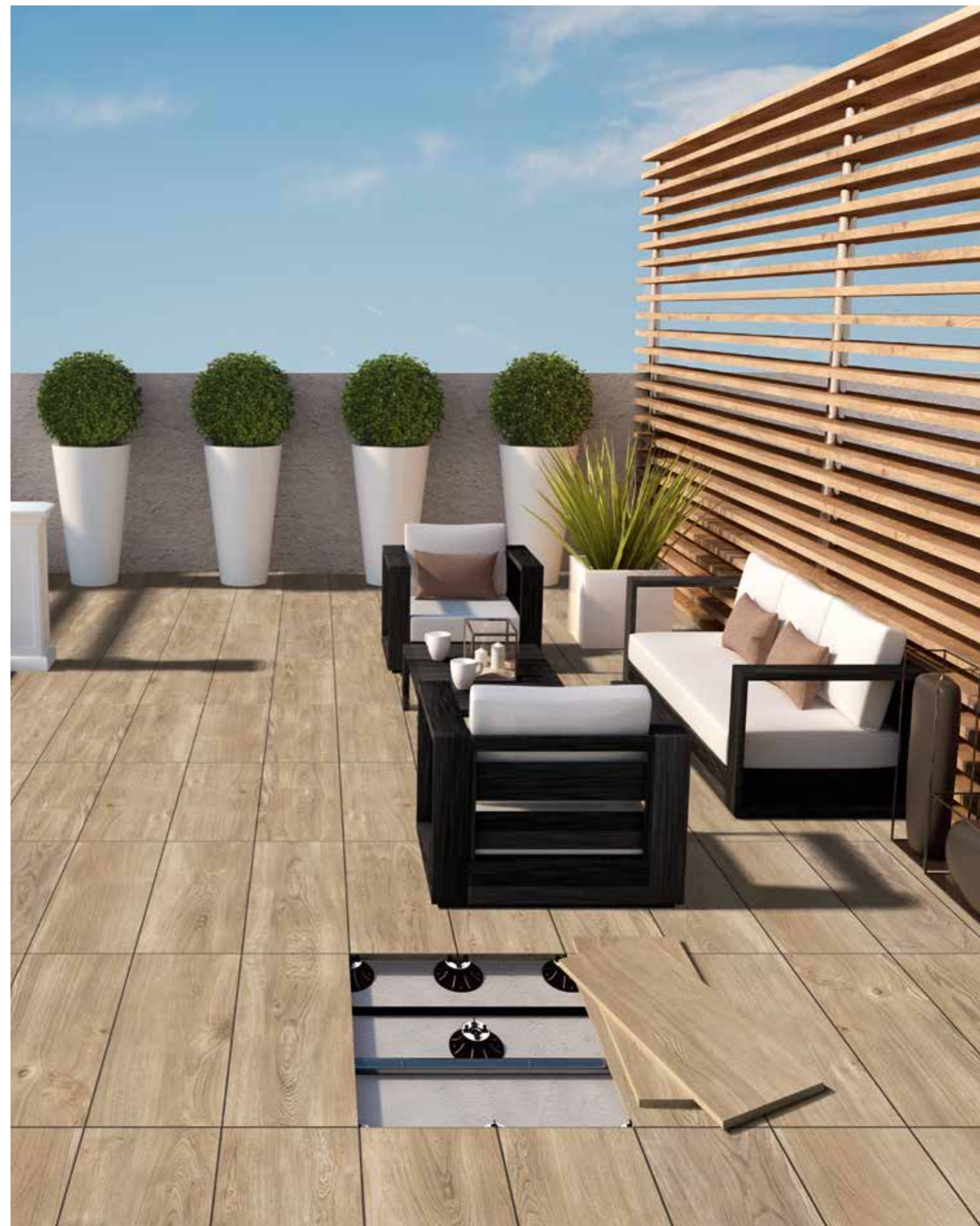

FP2 Honning
40x122 cm . 16"x48" RS

NORTH WIND

grès porcellanato
porcelain stoneware . grès cérame . feinsteinzeug

Formati
Sizes - Formats - Formate



26,0x160,0 cm R / 10"x62" R



30,5x122,6 cm R / 12"x48" R



20,3x122,6 cm R / 8"x48" R
20,3x122,6 cm R - outdoor/
8"x48" R - outdoor

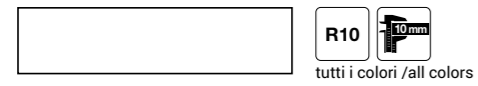

22x90 cm R / 9"x36" R

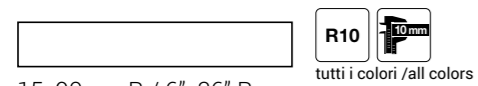

15x90 cm R / 6"x36" R
15x90 cm R - outdoor/
6"x36" R - outdoor



FP2 40x122 cm RS / 16"x48" RS

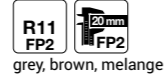

FP2 45x90 cm RS / 18"x36" RS



15x61 cm R / 6"x24" R
15x61 cm R - outdoor/
6"x24" R - outdoor



Colori
Colours - Couleurs - Farbe

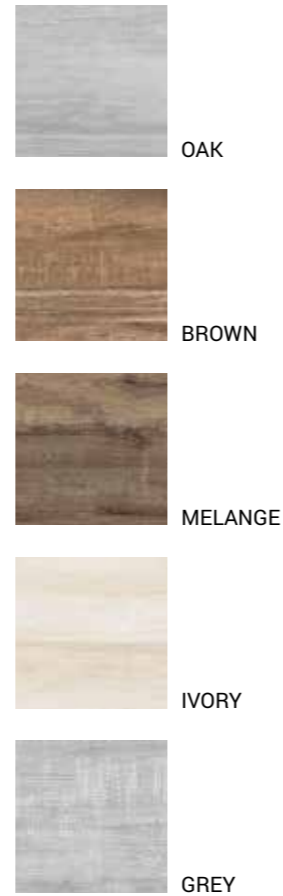

effetto legno
wood-look
effet bois
holzoptik

rivestimento coordinato - matching wall tiles - faïences coordonnées - koordinierte wandfliesen:

North Wind 20x50 cm . 8"x20" - 18mm

bicottura tradizionale
traditional double fired - traditionnelle double feue - zweibrandfliesen

Formati
Sizes - Formats - Formate

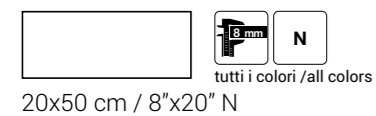

20x50 cm / 8"x20" N

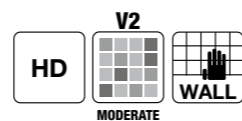

Colori
Colours - Couleurs - Farbe



Grey
30,5x122,6 cm . 12"x48" R - 20,3x122,6 cm . 8"x48" R

NORTH WIND



oak

26,0x160,0 cm 10"x62"	R	A90
30,5x122,6 cm 12"x48"	R	A120
20,3x122,6 cm 8"x48"	R	A30
22x90 cm 9"x36"	R	A70
15x90 cm 6"x36"	R	A20
15x61 cm 6"x24"	R	A10



brown

26,0x160,0 cm 10"x62"	R	A90
30,5x122,6 cm 12"x48"	R	A120
20,3x122,6 cm 8"x48"	R	A30
20,3x122,6 cm 8"x48" OUTDOOR	R	A31
22x90 cm 9"x36"	R	A70
15x90 cm 6"x36"	R	A20
15x90 cm 6"x36" OUTDOOR	R	A21
15x61 cm 6"x24"	R	A10
15x61 cm 6"x24" OUTDOOR	R	A11

FP2

45x90 cm 18"x36" FP2	RS	A171
40x122 cm 16"x48" FP2	RS	A150



melange

26,0x160,0 cm 10"x62"	R	A90
30,5x122,6 cm 12"x48"	R	A120
20,3x122,6 cm 8"x48"	R	A30
22x90 cm 9"x36"	R	A70
15x90 cm 6"x36"	R	A20
15x90 cm 6"x36" OUTDOOR	R	A21
15x61 cm 6"x24"	R	A10

FP2

45x90 cm 18"x36" FP2	RS	A171
40x122 cm 16"x48" FP2	RS	A150



ivory

26,0x160,0 cm 10"x62"	R	A90
30,5x122,6 cm 12"x48"	R	A120
20,3x122,6 cm 8"x48"	R	A30
22x90 cm 9"x36"	R	A70
15x90 cm 6"x36"	R	A20
15x90 cm 6"x36" OUTDOOR	R	A21
15x61 cm 6"x24"	R	A10
15x61 cm 6"x24" OUTDOOR	R	A11



grey

26,0x160,0 cm 10"x62"	R	A90
30,5x122,6 cm 12"x48"	R	A120
20,3x122,6 cm 8"x48"	R	A30
20,3x122,6 cm 8"x48" OUTDOOR	R	A31
22x90 cm 9"x36"	R	A70
15x90 cm 6"x36"	R	A20
15x90 cm 6"x36" OUTDOOR	R	A21
15x61 cm 6"x24"	R	A10
15x61 cm 6"x24" OUTDOOR	R	A11

FP2

45x90 cm 18"x36" FP2	RS	A171
40x122 cm 16"x48" FP2	RS	A150

NORTH WIND

sviluppo grafico - design development - développement graphique - grafische entwicklung 20,3x122,6 cm . 8"x48" R
(21 grafiche diverse . 21 different design . 21 graphiques différents . 21 verschiedene Grafische)



oak



brown



melange



ivory



grey

NORTH WIND

decori - decors - décors - dekors

stripe monocolora 18 tessere 5x10 - 30x30 cm 12"x12" **P82** 7



ivory

grey

melange

stripe mix 18 tessere 5x10
30x30 cm 12"x12" **P82** 7



brown/oak

mosaico mix 36 tessere 5x5
30x30 cm 12"x12" **P71** 7



ivory/ grey

brown/oak

pezzi speciali - special pieces
pièces spéciales - formteile

battiscopa
7x90 cm 2 7/8"x36" **R P03** 10



ivory

grey

oak

brown

melange

elemento "L" monolitico outdoor **P51** 2
15x61x4 cm 6"x24"x1 3/4"



ivory

brown

grey

melange

step
30,4x61,0 cm 12"x24" **R P90**

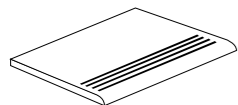

ivory

grey

oak

brown

melange

gradino costa retta
34x122,6x4 cm 13"x48"x1 3/4" **R P32**
34x61,0x4 cm 13"x24"x1 3/4" **R P31**



ivory

grey

oak

brown

melange

angolare costa retta dx/sx
34x122,6x4 cm 13"x48"x1 3/4" **R P41**
34x34x4 cm 13"x13"x1 3/4" **R P40**

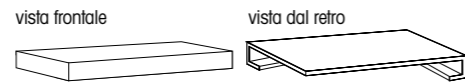

vista frontale

vista dal retro

ivory

grey

oak

brown

melange

Note - Notes - Notes - Anmerkungen

I battiscopa e gli elementi "L" vengono venduti a pz. e a scatola completa. Tutti gli altri pezzi speciali vengono venduti al pezzo. I gradini vengono prodotti solo su ordinazione (tempo minimo di consegna 20 gg lavorativi).
All skirting and monolithic L elements, priced per piece, are sold in full box. All other special trims are sold by piece. Steps are produced only on request (minimum delivery terms of 20 days).
Les plinthes et élément "L" sont vendues la pièce et par boîte complète. Les autres pièces spéciales sont vendus la pièce. Le plat de marche sont produit sur demande (délai minimum de 20 jours).
Die Sockelleisten und Stufen werden pro Stk. und Vollen Kartons verkauft. Stufen und Stufenecken werden nur auf Bestellung produziert (Lieferzeiten mindesten 20 arbeitstagen ab Auftragserteilung).

NORTH WIND wall

bicottura tradizionale

traditional double fired - traditionnelle double feue - zweibrandfliesen

rivestimento coordinato - matching wall tiles - faïences coordonnées - koordinierte wandfliesen



white

20x50 cm 8"x20"

N A60



ivory

20x50 cm 8"x20"

N A60



grey

20x50 cm 8"x20"

N A60



oak

20x50 cm 8"x20"

N A60

decori - decors - décors - dekors



muretto 3D cold
20x50 cm 8"x20"

N A61



muretto 3D warm
20x50 cm 8"x20"

N A61



muretto 3D WARM 20x50 cm . 8"x20" N

NORTH WIND **FP2**

technical project
FP2
outdoor



brown

45x90 cm 18"x36" **FP2**

40x122 cm 16"x48" **FP2**



RS **A171**

RS **A150**



melange

45x90 cm 18"x36" **FP2**

40x122 cm 16"x48" **FP2**



RS **A171**

RS **A150**



grey

45x90 cm 18"x36" **FP2**

40x122 cm 16"x48" **FP2**



RS **A171**

RS **A150**

FP2 pezzi speciali - special pieces - pièces spéciales - formteile

*Griglia e griglia angolo 20x61 cm abbinare al formato 40x122 cm.
Grille and corner grille 8"x24" combined with the 16"x48" size.

elemento "L"

45x90x5 cm 18"x36"x2" **RS P101**
40x122x5 cm 16"x48"x2" **RS P102**

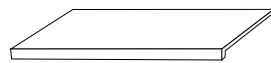

brown
melange
grey

angolare elemento "L"

45x90x5 cm 18"x36"x2" **RS P104**
40x122x5 cm 16"x48"x2" **RS P105**



brown
melange
grey

griglia

20x90 cm 8"x36" **RS P118**
*20x61,0 cm 8"x24" **RS P106**

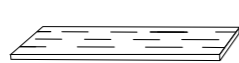

brown
melange
grey

griglia angolo

20x90 cm 8"x36" **RS P108 COPPIA**
*20x61,0 cm 8"x24" **RS P109 COPPIA**



brown
melange
grey

round lineare

45x90 cm 18"x36" **RS P111**
40x122 cm 16"x48" **RS P112**

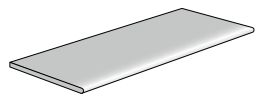

brown
melange
grey

round angolare

45x90 cm 18"x36" **RS P120 COPPIA**
40x122 cm 16"x48" **RS P113 COPPIA**

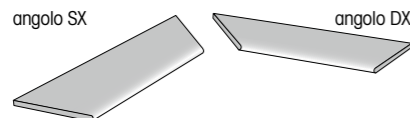

brown
melange
grey

angolo bordo toro

45x90 cm 18"x36" **RS P115**
40x122 cm 16"x48" **RS P116**

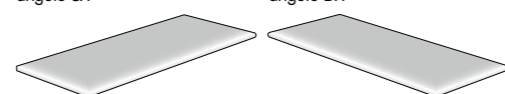

brown
melange
grey

Note - Notes - Notes - Anmerkungen

I pezzi speciali FP2 vengono venduti al pezzo e solo su ordinazione (tempo minimo di consegna 20 gg lavorativi dall'ordine)

The special pieces FP2 are sold by piece and only on request (minimum delivery time 20 working days from date of order).

Les pièces spéciales FP2 sont vendus à la pièce et uniquement sur commande (délai minimum de livraison 20 jours ouvrés à partir de la commande).

Spezial Teile FP2 sind pro Stück verkauft und nur auf Bestellungen produziert. (Lieferzeiten mindesten 20 arbeitstage ab Auftragbestätigung)



FP2 Grey
40x122 cm . 16"x48" RS

INTARSIO

grès porcellanato
porcelain stoneware . grès cérame . feinsteinzeug

effetto legno
wood-look
effet bois
holzoptik



Formati
Sizes - Formats - Formate

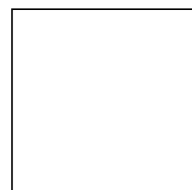

61,0x61,0 cm R /
24"x24" R

Colori
Colours - Couleurs - Farbe



BIANCO



GRIGIO



MIELE



MORO

R RETTIFICATO
RECTIFIED



Grigio
61,0x61,0 cm . 24"x24" R

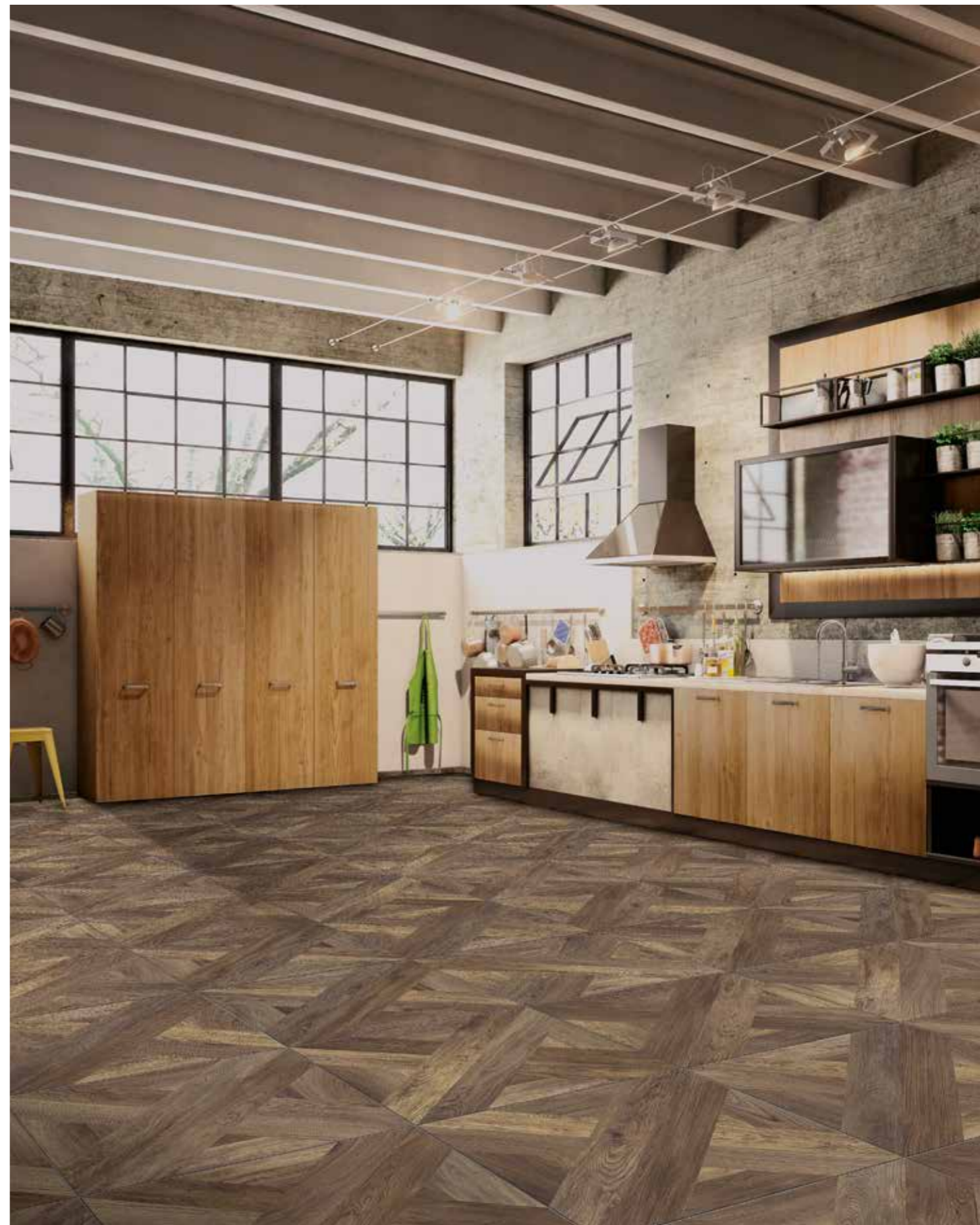

Moro
61,0x61,0 cm . 24"x24" R

INTARSIO



bianco

61,0x61,0 cm 24"x24"

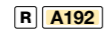

grigio

61,0x61,0 cm 24"x24"

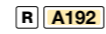

miele

61,0x61,0 cm 24"x24"

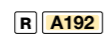

moro

61,0x61,0 cm 24"x24"

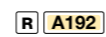

INTARSIO

sviluppo grafico - design development - développement graphique - grafische entwicklung 61,0x61,0 cm . 24x24" R
(8 grafiche diverse . 8 different design . 8 graphiques différents . 8 verschiedene Grafische)



bianco



grigio



miele



moro

CHALET

grès porcellanato
porcelain stoneware . grès cérame . feinsteinzeug

effetto legno
wood-look
effet bois
holzoptik



Formati
Sizes - Formats - Formate

Colori
Colours - Couleurs - Farbe

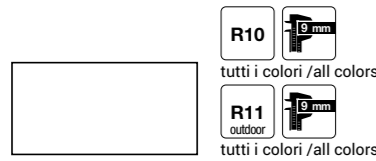

30,8x61,5 cm N / 12"x24" N
30,8x61,5 cm N - outdoor/
12"x24" N - outdoor

N NATURALE
NATURAL

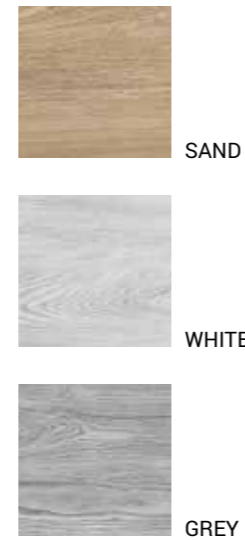

Sand
30,8x61,5 cm . 12"x24" N

CHALET



white

30,8x61,5 cm 12"x24" **N** **A142**
30,8x61,5 cm 12"x24" OUTDOOR **N** **A143**

sand

30,8x61,5 cm 12"x24" **N** **A142**
30,8x61,5 cm 12"x24" OUTDOOR **N** **A143**

grey

30,8x61,5 cm 12"x24" **N** **A142**
30,8x61,5 cm 12"x24" OUTDOOR **N** **A143**

decori - decors - décors - dekors

mosaico monocolor 36 tessere 5x5 - 30x30 cm 12"x12" **P71** **7**



pezzi speciali - special pieces - pièces spéciales - formteile

elemento "L" monolitico outdoor
15x61x4 cm 6"x24"x1 3/4" **P51** **2**

battiscopa
7,5x61,5 cm 3"x24" **N** **P10** **12**



sand

step
30,8x61,5 cm 12"x24" **N** **P92**

gradino costa retta
30,8x61,5x4 cm 12"x24"x1 3/4" **N** **P31**

angolare costa retta dx/sx
30,8x30,8x4 cm 12"x12"x1 3/4" **N** **P40**

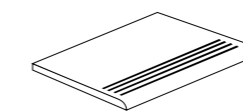

sand
white
grey

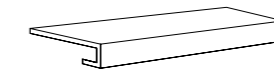

sand
white
grey

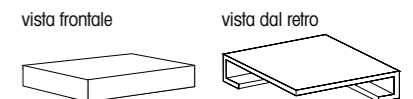

sand
white
grey

Note - Notes - Notes - Anmerkungen
I battiscopa e gli elementi "L" vengono venduti a pz. e a scatola completa. Tutti gli altri pezzi speciali vengono venduti al pezzo. I gradini vengono prodotti solo su ordinazione (tempo minimo di consegna 20 gg lavorativi).
All skirting and monolithic L elements, priced per piece, are sold in full box. All other special trims are sold by piece. Steps are produced only on request (minimum delivery terms of 20 days).
Les plinthes et élément "L" sont vendues la pièce et par boîte complète. Les autres pièces spéciales sont vendues la pièce. Le plat de marche sont produit sur demande (délai minimum de 20 jours).
Die Sockelleisten und Stufen werden pro Stk. und Vollen Kartons verkauft. Stufen und Stufenecken werden nur auf Bestellung produziert (Lieferzeiten mindesten 20 arbeitstagen ab Auftragserteilung).

effetto cotto - cotto-look - effet cotto - cottooptik



effetto cotto
cotto-look
effet cotto
cottooptik

camelot	172
terre toscane	178



IL CAVALLINO
CERAMICHE since 1968

CAMELOT

grès porcellanato
porcelain stoneware . grès cérame . feinsteinzeug

effetto cotto
cotto-look
effet cotto
cottooptik



Formati
Sizes - Formats - Formate

Colori
Colours - Couleurs - Farbe



30,6x30,6 cm N-BM /
12"x12" N-BM

15,1x30,6 cm N-BM /
6"x12" N-BM
15,1x30,6 cm N-BM - outdoor/
6"x12" N-BM - outdoor

Materiale non esattamente calibrato; prevedere fuga di 5 mm.
Calibration of this product is not exact; please considerer a 5 mm joint.
Matériel non calibré de manière précise; prévoir un joint de 5 mm.
Nicht exakt rektifiziertes Material, es muss eine Fuge von 5 mm vorgesehen werden.

Formati 30,6x30,6 e 15,1x30,6 prodotti con bordi irregolari e angoli arrotondati.
30,6x30,6 and 15,1x30,6 sizes produced with uneven edges and rounded corners.
Formats 30,6x30,6 et 15,1x30,6 produits avec bords irréguliers et angles arrondis.
Format 30,6x30,6 und 15,1x30,6, mit unregelmäßigen Kanten und abgerundeten Ecken.

N/BM NATURALE/BORDO MOSSO
NATURAL/SLIGHT EDGES



BEIGE



TRAMONTO



COTTO



Cotto
30,6x30,6 cm . 12"x12" N/BM - 15,1x30,6 cm . 6"x12" N/BM



indoor: Beige 30,6x30,6 cm . 12"x12" N/BM
outdoor: Beige 15,1x30,6 cm . 6"x12" N/BM outdoor - elemento "L" monolitico outdoor 15x30x4 cm . 6"x12"x1^{3/4}"



beige

30,6x30,6 cm 12"x12"

N/BM A132



beige

15,1x30,6 cm 6"x12"

N/BM A01

15,1x30,6 cm 6"x12" OUTDOOR

N/BM A02

Materiale non esattamente calibrato; prevedere fuga di 5 mm.
Calibration of this product is not exact; please consider a 5 mm joint.
Matériel non calibré de manière précise; prévoir un joint de 5 mm.
Nicht exakt rektifiziertes Material, es muss eine Fuge von 5 mm vorgesehen werden.

Formati 30,6x30,6 e 15,1x30,6 prodotti con bordi irregolari e angoli arrotondati.
30,6x30,6 and 15,1x30,6 sizes produced with uneven edges and rounded corners.
Formats 30,6x30,6 et 15,1x30,6 produits avec bords irréguliers et angles arrondis.
Format 30,6x30,6 und 15,1x30,6, mit unregelmäßigen Kanten und abgerundeten Ecken.



cotto

30,6x30,6 cm 12"x12"

N/BM A132



cotto

15,1x30,6 cm 6"x12"

N/BM A01

15,1x30,6 cm 6"x12" OUTDOOR

N/BM A02

Materiale non esattamente calibrato; prevedere fuga di 5 mm.
Calibration of this product is not exact; please consider a 5 mm joint.
Matériel non calibré de manière précise; prévoir un joint de 5 mm.
Nicht exakt rektifiziertes Material, es muss eine Fuge von 5 mm vorgesehen werden.

Formati 30,6x30,6 e 15,1x30,6 prodotti con bordi irregolari e angoli arrotondati.
30,6x30,6 and 15,1x30,6 sizes produced with uneven edges and rounded corners.
Formats 30,6x30,6 et 15,1x30,6 produits avec bords irréguliers et angles arrondis.
Format 30,6x30,6 und 15,1x30,6, mit unregelmäßigen Kanten und abgerundeten Ecken.

esempi di posa . laying compositions . exemple de pose . verlegemuster

Beige 30,6x30,6 cm . 12"x12" N/BM



Beige 15,1x30,6 cm . 6"x12" N/BM



esempi di posa . laying compositions . exemple de pose . verlegemuster

Cotto 30,6x30,6 cm . 12"x12" N/BM



Cotto 15,1x30,6 cm . 6"x12" N/BM



CAMELOT



tramonto

30,6x30,6 cm 12"x12"

N/BM A132

Materiale non esattamente calibrato; prevedere fuga di 5 mm.
Calibration of this product is not exact; please considerer a 5 mm joint.
Matériel non calibré de manière précise; prévoir un joint de 5 mm.
Nicht exakt rektifiziertes Material, es muss eine Fuge von 5 mm vorgesehen werden.

Formati 30,6x30,6 e 15,1x30,6 prodotti con bordi irregolari e angoli arrotondati.
30,6x30,6 and 15,1x30,6 sizes produced with uneven edges and rounded corners.
Formats 30,6x30,6 et 15,1x30,6 produits avec bords irréguliers et angles arrondis.
Format 30,6x30,6 und 15,1x30,6, mit unregelmäßigen Kanten und abgerundeten Ecken.



tramonto

15,1x30,6 cm 6"x12"

N/BM A01

15,1x30,6 cm 6"x12" OUTDOOR

N/BM A02

esempi di posa . laying compositions . exemple de pose . verlegemuster

Tramonto 30,6x30,6 cm . 12"x12" N/BM



Tramonto 15,1x30,6 cm . 6"x12" N/BM



CAMELOT



Tramonto

15,1x30,6 cm . 6"x12" N/BM outdoor

elemento "L" monolitico outdoor 15x30x4 cm . 6"x12"x1^{3/4}"

decori - decors - décors - dekors

mosaico mix 36 tessere 5x5

30x30 cm 12"x12" **P71**  7



pezzi speciali - special pieces - pièces spéciales - formteile

elemento "L" monolitico outdoor
15x30x4 cm 6"x12"x1^{3/4}" **P50**  4

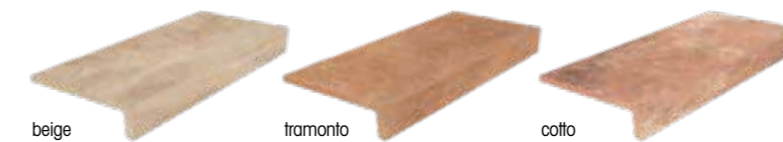

beige

tramonto

cotto

battiscopa
7,5x30,6 cm 3"x12" **P08**  36



beige

tramonto

cotto

step
30,6x30,6 cm 12"x12" **N P91**

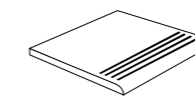

beige

tramonto

cotto

gradino con toro incollato
30,6x30,6 cm 12"x12" **N P20**

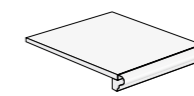

beige

tramonto

cotto

angolare con toro incollato
30,6x30,6 cm 12"x12" **N P21**

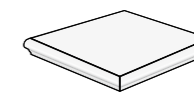

beige

tramonto

cotto

Note - Notes - Notes - Anmerkungen

I battiscopa e gli elementi "L" vengono venduti a pz. e a scatola completa. Tutti gli altri pezzi speciali vengono venduti al pezzo. I gradini vengono prodotti solo su ordinazione (tempo minimo di consegna 20 gg lavorativi).
All skirting and monolithic L elements, priced per piece, are sold in full box. All other special trims are sold by piece. Steps are produced only on request (minimum delivery terms of 20 days).
Les plinthes et élément "L" sont vendues la pièce et par boîte complète. Les autres pièces spéciales sont vendus la pièce. Le plat de marche sont produit sur demande (délai minimum de 20 jours).
Die Sockelleisten und Stufen werden pro Stk. und Vollen Kartons verkauft. Stufen und Stufenecken werden nur auf Bestellung produziert (Lieferzeiten mindesten 20 arbeitstagen ab Auftragserteilung).

TERRE TOSCANE

grès porcellanato
porcelain stoneware . grès cérame . feinsteinzeug

effetto cotto
cotto-look
effet cotto
cottooptik



Formati
Sizes - Formats - Formate

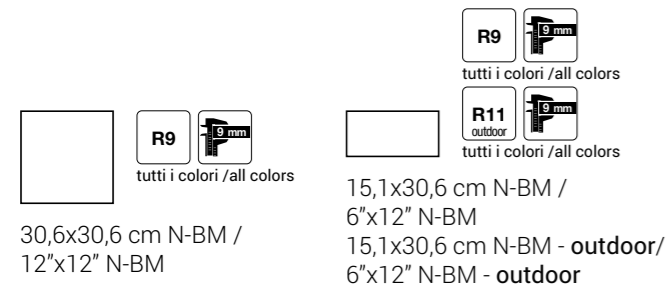

Materiale non esattamente calibrato; prevedere fuga di 5 mm.
Calibration of this product is not exact; please considerer a 5 mm joint.
Matériel non calibré de manière précise; prévoir un joint de 5 mm.
Nicht exakt rektifiziertes Material, es muss eine Fuge von 5 mm vorgesehen werden.

Formati 30,6x30,6 e 15,1x30,6 prodotti con bordi irregolari e angoli arrotondati.
30,6x30,6 and 15,1x30,6 sizes produced with uneven edges and rounded corners.
Formats 30,6x30,6 et 15,1x30,6 produits avec bords irréguliers et angles arrondis.
Format 30,6x30,6 und 15,1x30,6, mit unregelmäßigen Kanten und abgerundeten Ecken.

N/BM NATURALE/BORDO MOSSO
NATURAL/SLIGHT EDGES

Colori
Colours - Couleurs - Farbe



Volterra
15,1x30,6 cm . 6"x12" N/BM outdoor



Vinci
30,6x30,6 cm . 12"x12" N/BM - formella Mix B 30,6x30,6 cm . 12"x12" N

TERRE TOSCANE



volterra
30,6x30,6 cm 12"x12" N/BM **A132**



volterra
15,1x30,6 cm 6"x12" N/BM **A01**
15,1x30,6 cm 6"x12" OUTDOOR N/BM **A02**

Materiale non esattamente calibrato; prevedere fuga di 5 mm.
Calibration of this product is not exact; please considerer a 5 mm joint.
Matériel non calibré de manière précise; prévoir un joint de 5 mm.
Nicht exakt rektifiziertes Material, es muss eine Fuge von 5 mm vorgesehen werden.

Formati 30,6x30,6 e 15,1x30,6 prodotti con bordi irregolari e angoli arrotondati.
30,6x30,6 and 15,1x30,6 sizes produced with uneven edges and rounded corners.
Formats 30,6x30,6 et 15,1x30,6 produits avec bords irréguliers et angles arrondis.
Format 30,6x30,6 und 15,1x30,6, mit unregelmäßigen Kanten und abgerundeten Ecken.

esempi di posa . laying compositions . exemple de pose . verlegemuster

Volterra 30,6x30,6 cm . 12"x12" N/BM



Volterra 15,1x30,6 cm . 6"x12" N/BM



TERRE TOSCANE



san gimignano
30,6x30,6 cm 12"x12" N/BM **A132**



san gimignano
15,1x30,6 cm 6"x12" N/BM **A01**
15,1x30,6 cm 6"x12" OUTDOOR N/BM **A02**

Materiale non esattamente calibrato; prevedere fuga di 5 mm.
Calibration of this product is not exact; please considerer a 5 mm joint.
Matériel non calibré de manière précise; prévoir un joint de 5 mm.
Nicht exakt rektifiziertes Material, es muss eine Fuge von 5 mm vorgesehen werden.

Formati 30,6x30,6 e 15,1x30,6 prodotti con bordi irregolari e angoli arrotondati.
30,6x30,6 and 15,1x30,6 sizes produced with uneven edges and rounded corners.
Formats 30,6x30,6 et 15,1x30,6 produits avec bords irréguliers et angles arrondis.
Format 30,6x30,6 und 15,1x30,6, mit unregelmäßigen Kanten und abgerundeten Ecken.

esempi di posa . laying compositions . exemple de pose . verlegemuster

San Gimignano 30,6x30,6 cm . 12"x12" N/BM



San Gimignano 15,1x30,6 cm . 6"x12" N/BM



TERRE TOSCANE



vinci
30,6x30,6 cm 12"x12" **N/BM A132**



vinci
15,1x30,6 cm 6"x12" **N/BM A01**
15,1x30,6 cm 6"x12" OUTDOOR **N/BM A02**

Materiale non esattamente calibrato; prevedere fuga di 5 mm.
Calibration of this product is not exact; please consider a 5 mm joint.
Matériel non calibré de manière précise; prévoir un joint de 5 mm.
Nicht exakt rektifiziertes Material, es muss eine Fuge von 5 mm vorgesehen werden.

Formati 30,6x30,6 e 15,1x30,6 prodotti con bordi irregolari e angoli arrotondati.
30,6x30,6 and 15,1x30,6 sizes produced with uneven edges and rounded corners.
Formats 30,6x30,6 et 15,1x30,6 produits avec bords irréguliers et angles arrondis.
Format 30,6x30,6 und 15,1x30,6, mit unregelmäßigen Kanten und abgerundeten Ecken.

esempi di posa . laying compositions . exemple de pose . verlegemuster

Vinci 30,6x30,6 cm . 12"x12" N/BM



Vinci 15,1x30,6 cm . 6"x12" N/BM



TERRE TOSCANE

decori - decors - décors - dekors

formella mix B (12 facce) - 30,6x30,6 cm 12"x12" **N/BM A131**



mosaico monocolor 36 tessere 5x5 - 30x30 cm 12"x12" **P71**



volterra



san gimignano



vinci

pezzi speciali - special pieces - pièces spéciales - formteile

elemento "L" monolitico outdoor
15x30x4 cm 6"x12"x1 3/4" **P50** **4**

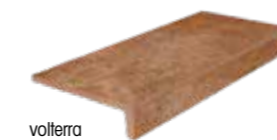

volterra



san gimignano



vinci

battiscopa
7,5x30,6 cm 3"x12" **P08** **36**



volterra



san gimignano



vinci

step
30,6x30,6 cm 12"x12" **N/BM P91**

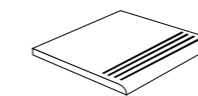

volterra

san gimignano

vinci

gradino con toro incollito
30,6x30,6 cm 12"x12" **N/BM P20**

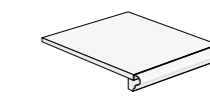

volterra

san gimignano

vinci

angolare con toro incollito
30,6x30,6 cm 12"x12" **N/BM P21**

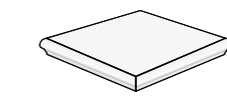

volterra

san gimignano

vinci

Note - Notes - Notes - Anmerkungen
I battiscopa e gli elementi "L" vengono venduti a pz. e a scatola completa. Tutti gli altri pezzi speciali vengono venduti al pezzo. I gradini vengono prodotti solo su ordinazione (tempo minimo di consegna 20 gg lavorativi).
All skirting and monolithic L elements, priced per piece, are sold in full box. All other special trims are sold by piece. Steps are produced only on request (minimum delivery terms of 20 days).
Les plinthes et élément "L" sont vendues la pièce et par boîte complète. Les autres pièces spéciales sont vendues la pièce. Le plat de marche sont produit sur demande (délai minimum de 20 jours).
Die Sockelleisten und Stufen werden pro Stk. und Vollen Kartons verkauft. Stufen und Stufenecken werden nur auf Bestellung produziert (Lieferzeiten mindesten 20 arbeitstagen ab Auftragserteilung).

grès porcellanato
porcelain stoneware . grès cérame . feinsteinzeug

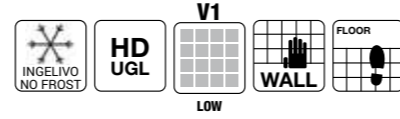

Formati
Sizes - Formats - Formate

Colori
Colours - Couleurs - Farbe

tutti i colori / all colors
20x20 cm N / 8"x8" N

NEVE

GRIGIO

BEIGE

neve
20x20 cm 8"x8"

grigio
20x20 cm 8"x8"

beige
20x20 cm 8"x8"

Beige, Neve 20x20 cm . 8"x8" N

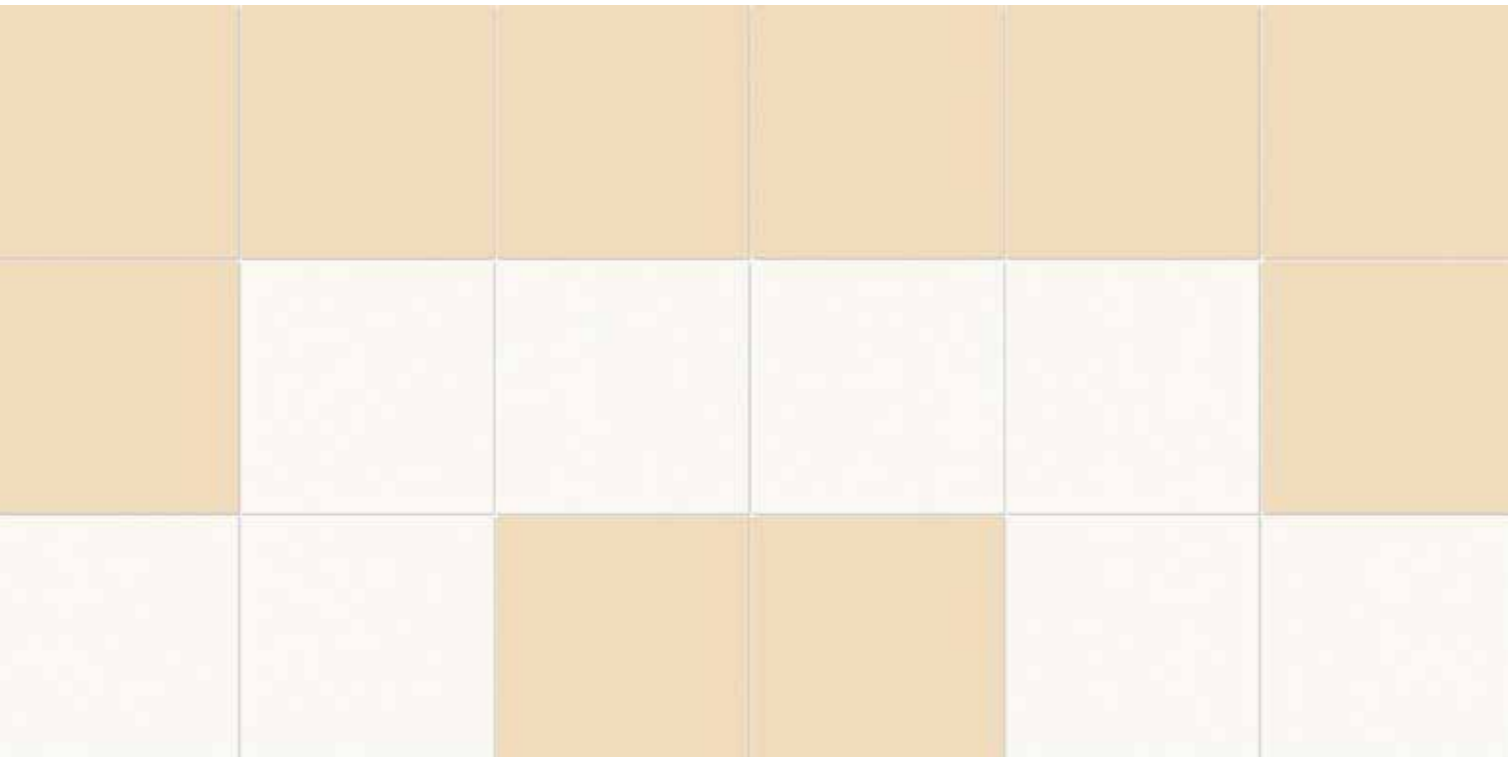

Grigio, Neve 20x20 cm . 8"x8" N

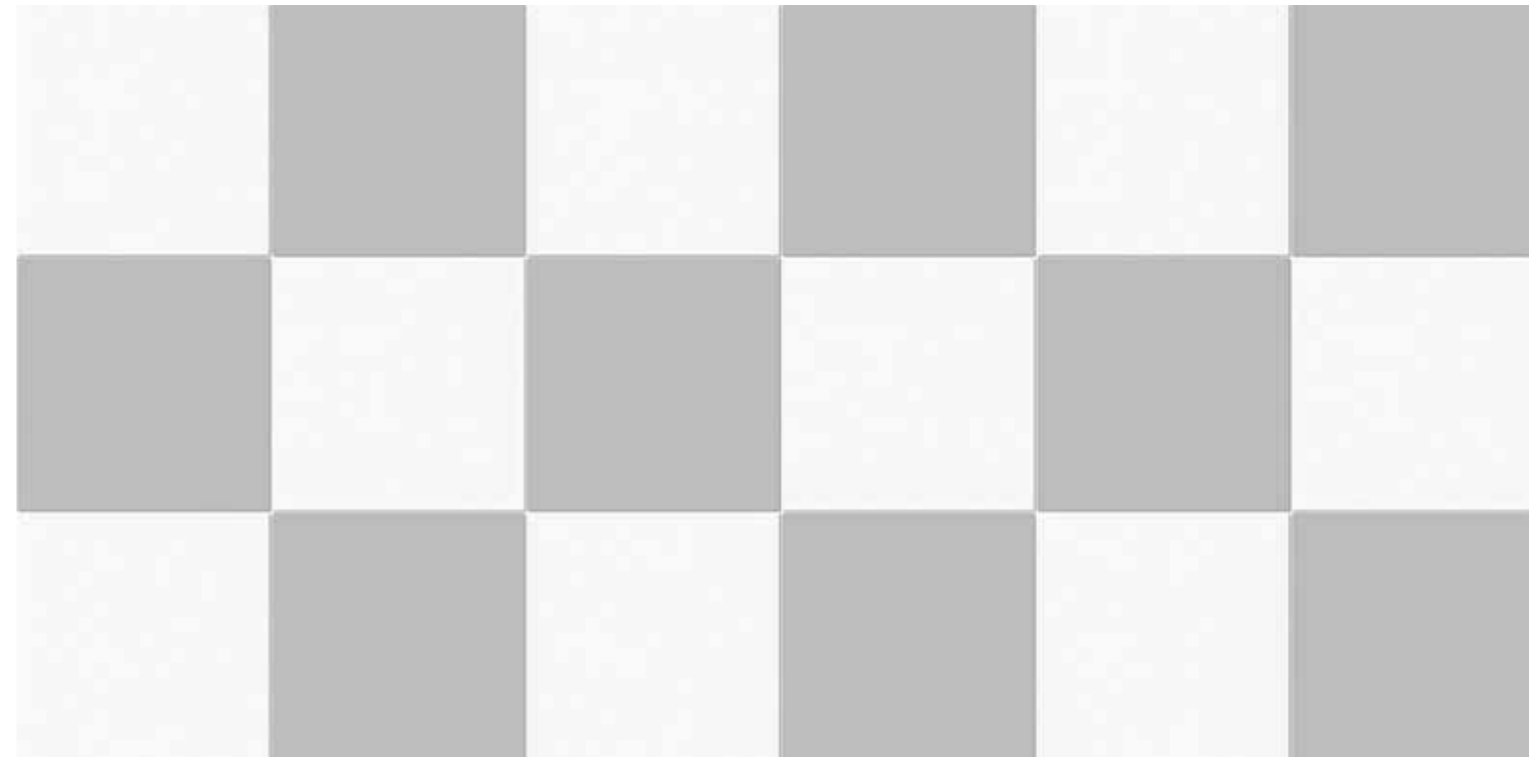

20x20 / 20x40

20x20
20x40



dimore 20x20 & 20x40	196
luserna 20x20 & 20x40	192
meteora 20x20 & 20x40	200
tribeca 20x20 & 20x40	194
vals 20x20 & 20x40	188



IL CAVALLINO
CERAMICHE since 1968

VALS 20x20/20x40

effetto pietra
stone-look
effet pierre
steinoptik

grès porcellanato
porcelain stoneware . grès cérame . feinsteinzeug



Formati
Sizes - Formats - Formate



30,8x61,5 cm NS - outdoor/
12"x24" NS - outdoor



20x40 cm NS - outdoor/
8"x16" NS - outdoor



20x20 cm NS - outdoor/
8"x8" NS - outdoor

Prevedere fuga di 4 mm.
Please considerer a 4 mm joint.
Prévoir un joint de 4 mm.
Es muss eine Fuge von 4 mm vorgesehen werden.

Il formato 30,8x61,5 non è modulare con i formati 20x40 e 20x20.
Combined laying is not possible because size 30,8x61,5 can not be modular with 20x40 e 20x20.
Le format 30,8x61,5 n'est pas modulable aux format 20x40 e 20x20.
Das Format 30,8x61,5 ist nicht modular mit die Formate 20x40 e 20x20.

NS NATURALE STRUTTURATO
NATURAL TEXTURED

Colori
Colours - Couleurs - Farbe



GHIACCIO



GRIGIO



MINERAL



BEIGE



Beige
20x40 cm . 8"x16" NS outdoor - 20x20 cm . 8"x8" NS outdoor

POSA 1

VALS 20x20/20x40



beige

30,8x61,5 cm 12"x24" OUTDOOR **NS** **A141**

20x40 cm 8"x16" OUTDOOR **NS** **A51**



beige

20x20 cm 8"x8" OUTDOOR **NS** **A43**



ghiaccio

30,8x61,5 cm 12"x24" OUTDOOR **NS** **A141**

20x40 cm 8"x16" OUTDOOR **NS** **A51**



ghiaccio

20x20 cm 8"x8" OUTDOOR **NS** **A43**



grigio

30,8x61,5 cm 12"x24" OUTDOOR **NS** **A141**

20x40 cm 8"x16" OUTDOOR **NS** **A51**



grigio

20x20 cm 8"x8" OUTDOOR **NS** **A43**



mineral

30,8x61,5 cm 12"x24" OUTDOOR **NS** **A141**

20x40 cm 8"x16" OUTDOOR **NS** **A51**



mineral

20x20 cm 8"x8" OUTDOOR **NS** **A43**

VALS 20x20/20x40

Grigio
20x40 cm . 8"x16" NS outdoor - 20x20 cm . 8"x8" NS outdoor

POSA 3



pezzi speciali - special pieces - pièces spéciales - formteile

battiscopa
6,5x40 cm 2 1/2"x16" **N** **P02** **20**

elemento "L" monolitico outdoor
15x30x4 cm 6"x12"x1 3/4" **P50** **4**

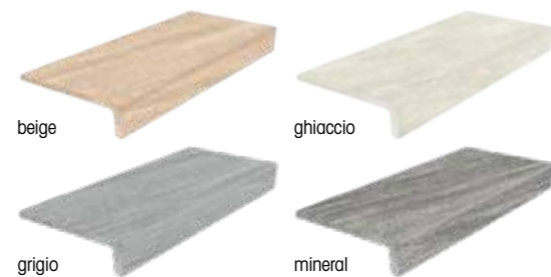

Note - Notes - Notes - Anmerkungen
I battiscopa e gli elementi "L" vengono venduti a pz. e a scatola completa. - All skirting and monolithic L elements, priced per piece, are sold in full box.
Les plinthes et élément "L" sont vendues la pièce et par boîte complète. - Die Sockelleisten und Stufen werden pro Stk. und Vollen Kartons verkauft.

VALS 20x20/20x40

sviluppo grafico - design development - développement graphique - grafische entwicklung 20x40 cm . 8"x16" NS
(30 grafiche diverse . 30 different design . 30 graphiques différents . 30 verschiedene Grafische)



beige



ghiaccio



grigio



mineral

LUSERNA 20x20/20x40

effetto pietra
stone-look
effet pierre
steinoptik

grès porcellanato
porcelain stoneware . grès cérame . feinsteinzeug



Formati
Sizes - Formats - Formate

R11 outdoor
tutti i colori / all colors
20x40 cm NS - outdoor/
8"x16" NS - outdoor

R11 outdoor
tutti i colori / all colors
20x20 cm NS - outdoor/
8"x8" NS - outdoor

Prevedere fuga di 4 mm.
Please considerer a 4 mm joint.
Prévoir un joint de 4 mm.
Es muss eine Fuge von 4 mm vorgesehen werden.

NS NATURALE STRUTTURATO
NATURAL TEXTURED

Colori
Colours - Couleurs - Farbe



Grey
20x40 cm . 8"x16" NS outdoor - 20x20 cm . 8"x8" NS outdoor

POSA 1

LUSERNA 20x20/20x40

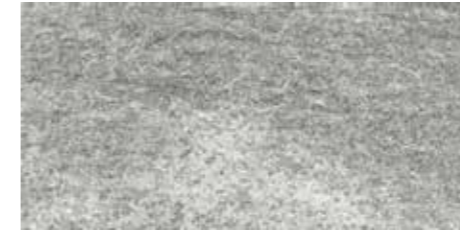

grey
20x40 cm 8"x16" OUTDOOR **NS A51**



ice
20x40 cm 8"x16" OUTDOOR **NS A51**



gold
20x40 cm 8"x16" OUTDOOR **NS A51**

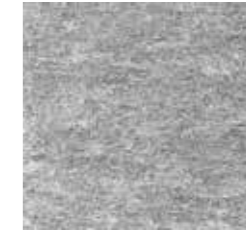

grey
20x20 cm 8"x8" OUTDOOR **NS A43**



ice
20x20 cm 8"x8" OUTDOOR **NS A43**

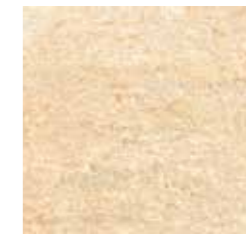

gold
20x20 cm 8"x8" OUTDOOR **NS A43**

pezzi speciali - special pieces - pièces spéciales - formteile

elemento "L" monolitico outdoor
15x30x4 cm 6"x12"x1 3/4" **P50**



battiscopa
6,5x40 cm 2 1/2"x16" **N P02**



Note - Notes - Notes - Anmerkungen
I battiscopa e gli elementi "L" vengono venduti a pz. e a scatola completa. - All skirting and monolithic L elements, priced per piece, are sold in full box.
Les plinthes et élément "L" sont vendues la pièce et par boîte complète. - Die Sockelleisten und Stufen werden pro Stk. und Vollen Kartons verkauft.

TRIBECA 20x20/20x40

effetto pietra
stone-look
effet pierre
steinoptik

grès porcellanato
porcelain stoneware . grès cérame . feinsteinzeug



Formati
Sizes - Formats - Formate

R11 outdoor
tutti i colori / all colors
20x40 cm NS - outdoor/
8"x16" NS - outdoor

R11 outdoor
tutti i colori / all colors
20x20 cm NS - outdoor/
8"x8" NS - outdoor

Prevedere fuga di 4 mm.
Please considerer a 4 mm joint.
Prévoir un joint de 4 mm.
Es muss eine Fuge von 4 mm vorgesehen werden.

NS NATURALE STRUTTURATO
NATURAL TEXTURED

Colori
Colours - Couleurs - Farbe

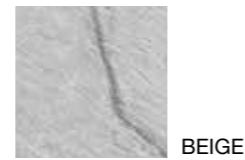
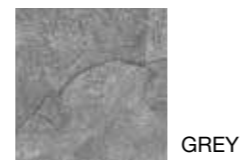

Grey
20x40 cm . 8"x16" NS outdoor - 20x20 cm . 8"x8" NS outdoor

POSA 1

TRIBECA 20x20/20x40

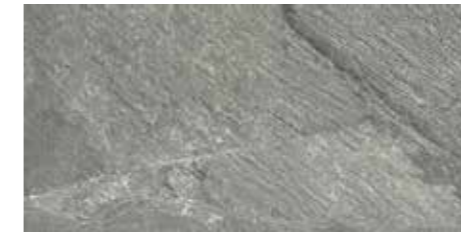

grey
20x40 cm 8"x16" OUTDOOR **NS A51**

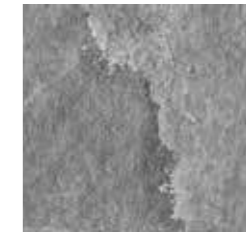

grey
20x20 cm 8"x8" OUTDOOR **NS A43**



beige
20x40 cm 8"x16" OUTDOOR **NS A51**

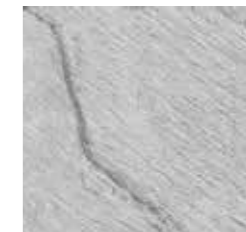

beige
20x20 cm 8"x8" OUTDOOR **NS A43**

pezzi speciali - special pieces - pièces spéciales - formteile

elemento "L" monolitico outdoor
15x30x4 cm 6"x12"x1 3/4" **P50** 4



battiscopa
6,5x61,0 cm 2 1/2"x24" **R P07** 12
6,5x40 cm 2 1/2"x16" **N P02** 20



Note - Notes - Notes - Anmerkungen
I battiscopa e gli elementi "L" vengono venduti a pz. e a scatola completa. - All skirting and monolithic L elements, priced per piece, are sold in full box.
Les plinthes et élément "L" sont vendues la pièce et par boîte complète. - Die Sockelleisten und Stufen werden pro Stk. und Vollen Kartons verkauft.

DIMORE 20x20/20x40

decoro

effetto cotto
cotto-look
effet cotto
cottooptik

grès porcellanato
porcelain stoneware . grès cérame . feinsteinzeug



Formati
Sizes - Formats - Formate

Colori
Colours - Couleurs - Farbe

R9 **5 mm**
tutti i colori / all colors

R11 outdoor **5 mm**
tutti i colori / all colors

20x40 cm NS / 8"x16" NS
20x40 cm NS - outdoor/
8"x16" NS - outdoor

R9 **5 mm**
caldo / freddo

20x20 cm NS - decoro/
8"x8" NS - decoro

NS NATURALE STRUTTURATO
NATURAL TEXTURED

Prevedere fuga di 4 mm.
Please considerer a 4 mm joint.
Prévoir un joint de 4 mm.
Es muss eine Fuge von 4 mm vorgesehen werden.

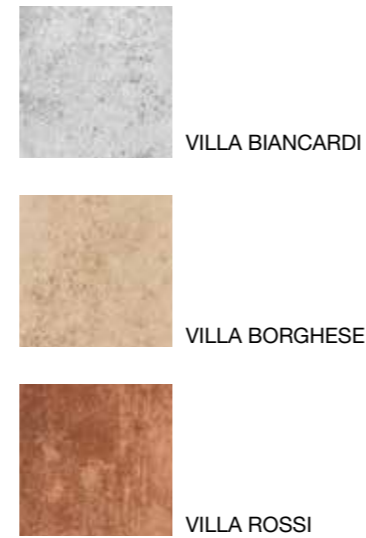

floor: Villa Rossi 20x40 cm . 8"x16" NS
wall: decoro Caldo 20x20 cm . 8"x8" NS

DIMORE 20x20/20x40

decoro



villa rossi
20x40 cm 8"x16" **NS A50**
20x40 cm 8"x16" OUTDOOR **NS A51**



villa borghese
20x40 cm 8"x16" **NS A50**
20x40 cm 8"x16" OUTDOOR **NS A51**

decori - decors - décors - dekors

fascia dimore mix - 20x40 cm 8"x16" **mix** **8** **P60**



villa biancardi
20x40 cm 8"x16" **NS A50**
20x40 cm 8"x16" OUTDOOR **NS A51**

pezzi speciali - special pieces - pièces spéciales - formteile

elemento "L" monolitico outdoor
15x30x4 cm 6"x12"x1 3/4" **P50** **4**



battiscopa
6,5x40 cm 2 1/2"x16" **N** **P02** **20**





Note - Notes - Notes - Anmerkungen
I battiscopa e gli elementi "L" vengono venduti a pz. e a scatola completa. - All skirting and monolithic L elements, priced per piece, are sold in full box.
Les plinthes et élément "L" sont vendues la pièce et par boîte complète. - Die Sockelleisten und Stufen werden pro Stk. und Vollen Kartons verkauft.

DIMORE 20x20/20x40

decoro

decori - decors - décors - dekors



decoro 20x20 cm 8"x8"  

12 soggetti diversi, miscelazione casuale. Disponibile in tutti i colori. - 12 assorted motifs, random mix. Available in all colours.
 12 sujets différents, mélange aléatoire. Disponible dans toutes les gammes de couleur. - 12 verschiedene Motive, Zufallsmischung. In allen Farben verfügbar.



decoro caldo



20x20 cm 8"x8" DECORO 



decoro freddo

20x20 cm 8"x8" DECORO 

DIMORE 20x20/20x40

decoro

sviluppo grafico - design development - développement graphique - grafische entwicklung 20x40 cm . 8"x16" NS
 (27 grafiche diverse . 27 different design . 27 graphiques différents . 27 verschiedene Grafische)



villa rossi



villa borghese



villa biancardi

METEORA 20x20/20x40

effetto cemento
concrete-look
effet ciment
zementoptik

grès porcellanato
porcelain stoneware . grès cérame . feinsteinzeug



Formati
Sizes - Formats - Formate

Colori
Colours - Couleurs - Farbe

 **R11** outdoor 
tutti i colori / all colors
20x40 cm NS - outdoor/
8"x16" NS - outdoor

 **R11** outdoor 
tutti i colori / all colors
20x20 cm NS - outdoor/
8"x8" NS - outdoor

Prevedere fuga di 4 mm.
Please considerer a 4 mm joint.
Prévoir un joint de 4 mm.
Es muss eine Fuge von 4 mm vorgesehen werden.

NS NATURALE STRUTTURATO
NATURAL TEXTURED

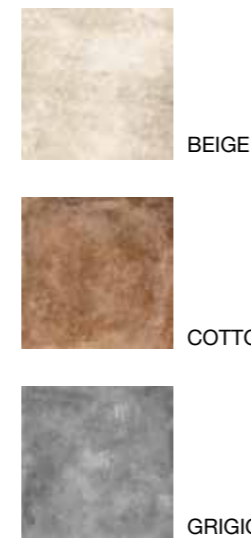

Beige
20x40 cm . 8"x16" NS outdoor - 20x20 cm . 8"x8" NS outdoor

POSA 7

METEORA 20x20/20x40



beige
20x40 cm 8"x16" OUTDOOR **NS A51**



cotto
20x40 cm 8"x16" OUTDOOR **NS A51**



grigio
20x40 cm 8"x16" OUTDOOR **NS A51**



beige
20x20 cm 8"x8" OUTDOOR **NS A43**



cotto
20x20 cm 8"x8" OUTDOOR **NS A43**





grigio
20x20 cm 8"x8" OUTDOOR **NS A43**

pezzi speciali - special pieces - pièces spéciales - formteile

elemento "L" monolitico outdoor
15x30x4 cm 6"x12"x1 3/4" **P50**  4



battiscopa
*6,5x61,0 cm 2 1/2"x24" **R P07**  12
*6,5x40 cm 2 1/2"x16" **N P01**  20



Note - Notes - Notes - Anmerkungen
I battiscopa e gli elementi "L" vengono venduti a pz. e a scatola completa. - All skirting and monolithic L elements, priced per piece, are sold in full box.
Les plinthes et élément "L" sont vendues la pièce et par boîte complète. - Die Sockelleisten und Stufen werden pro Stk. und Vollen Kartons verkauft.

20x20/20x40

Esempi di posa . Laying compositions . Exemple de pose . Verlegemuster **multiformato** . **multiformat**

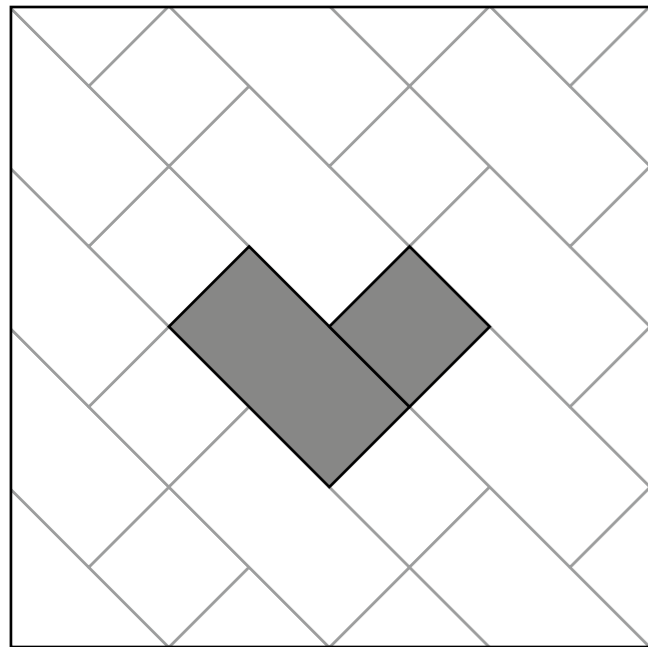

1	
20x40 - 8"x16"	66,60%
20x20 - 8"x8"	33,30%

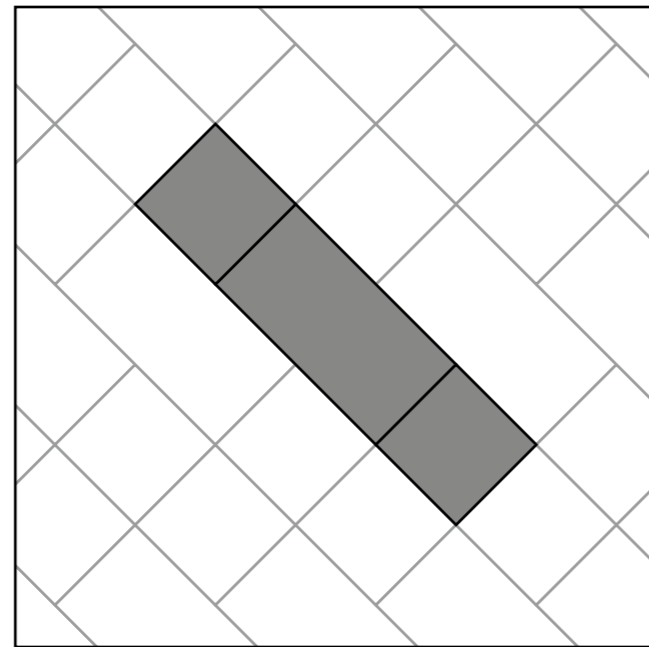

2	
20x40 - 8"x16"	50%
20x20 - 8"x8"	50%

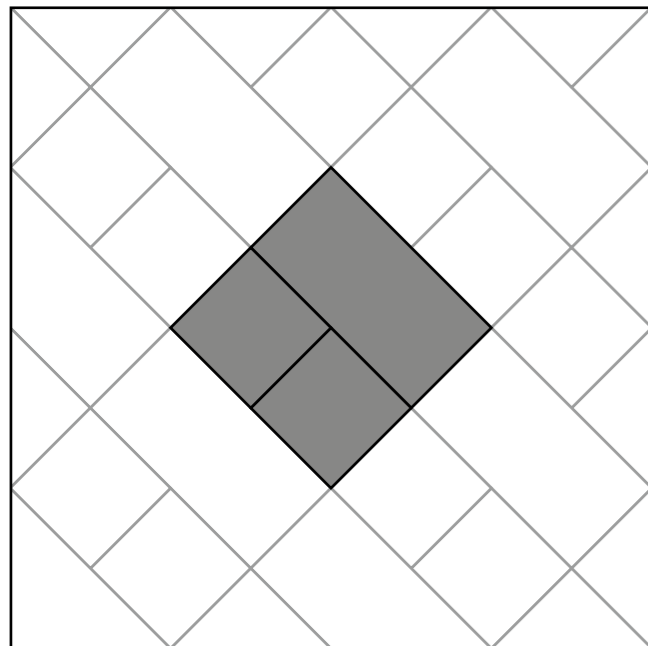

3	
20x40 - 8"x16"	50%
20x20 - 8"x8"	50%

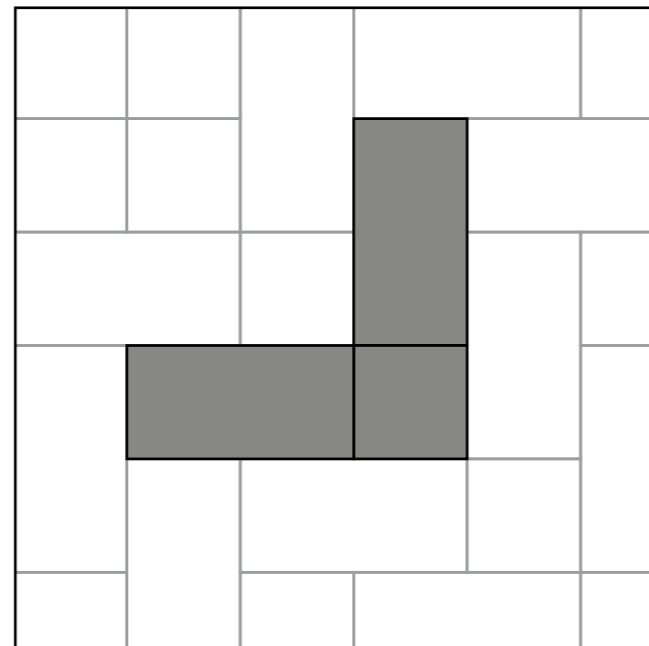

4	
20x40 - 8"x16"	80%
20x20 - 8"x8"	20%

20x20/20x40

Esempi di posa . Laying compositions . Exemple de pose . Verlegemuster **multiformato** . **multiformat**

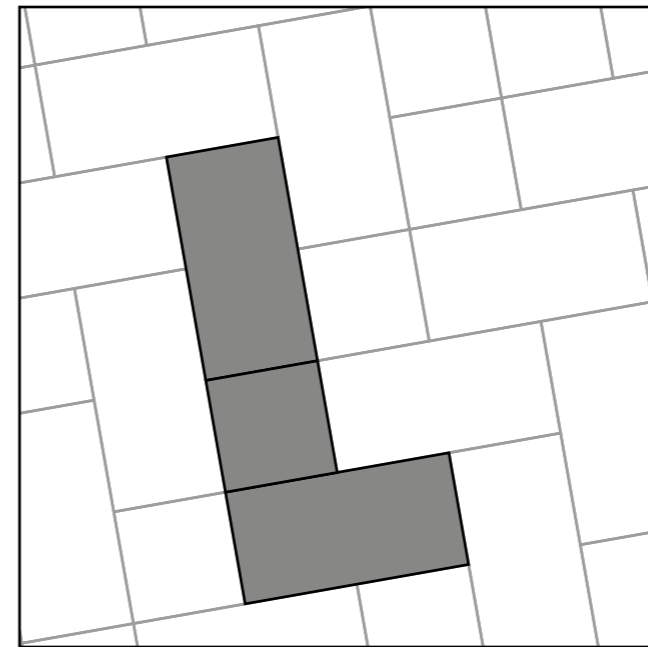

5	
20x40 - 8"x16"	80%
20x20 - 8"x8"	20%

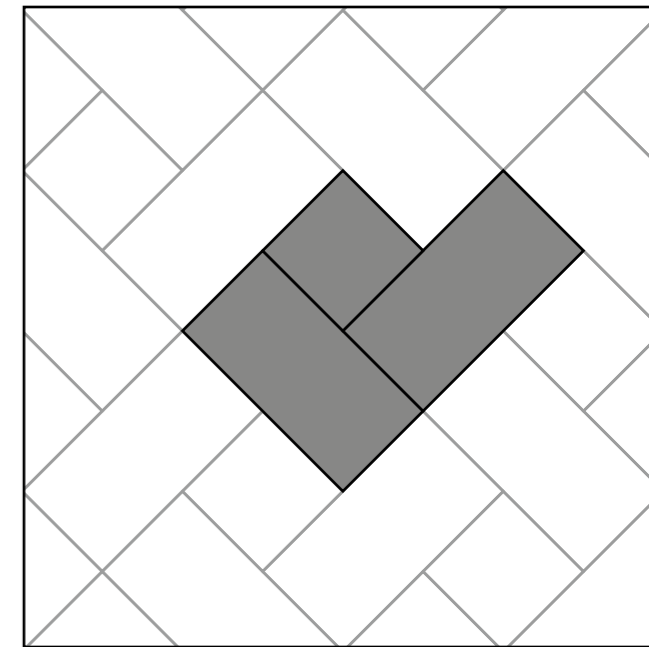

6	
20x40 - 8"x16"	80%
20x20 - 8"x8"	20%

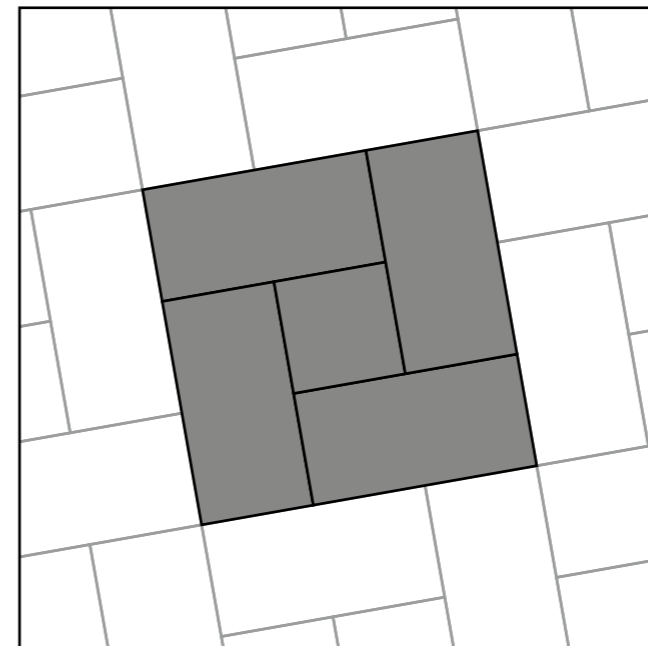

7	
20x40 - 8"x16"	88,89%
20x20 - 8"x8"	11,11%

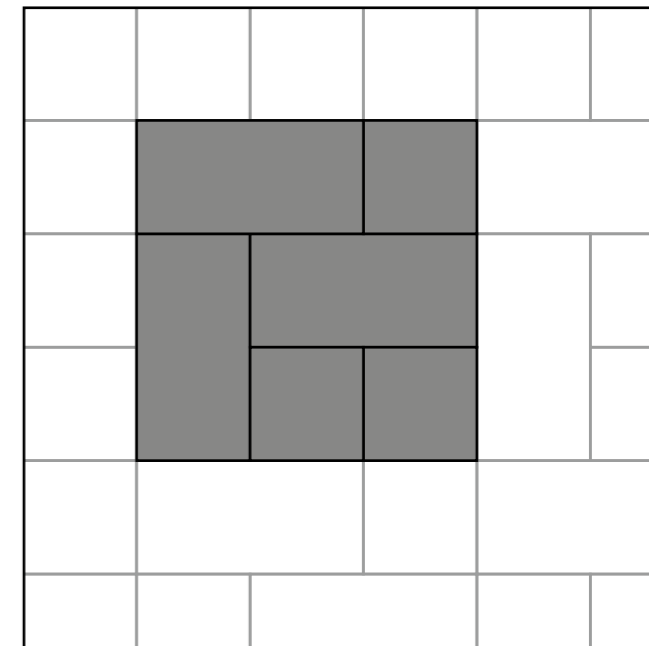

8	
20x40 - 8"x16"	66,70%
20x20 - 8"x8"	33,30%



EASY COLLECTION

by tuscania



easy
collection

beton		EASY COLLECTION	206
crystal		EASY COLLECTION	216
devon		EASY COLLECTION	212
modern		EASY COLLECTION	210
trevi		EASY COLLECTION	220
woody floor		EASY COLLECTION	216



IL CAVALLINO
CERAMICHE since 1968

BETON EASY COLLECTION

effetto cemento
concrete-look
effet ciment
zementoptik

grès porcellanato
porcelain stoneware . grès cérame . feinsteinzeug



Formati
Sizes - Formats - Formate

Colori
Colours - Couleurs - Farbe

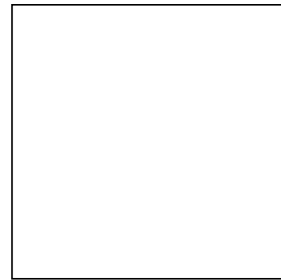

R9 
tutti i colori / all colors

90x90 cm RS / 36"x36" RS

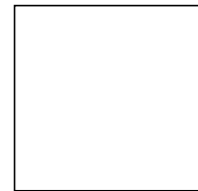

R9 
tutti i colori / all colors

61,0x61,0 cm RS / 24"x24" RS



R9 
tutti i colori / all colors
R11 outdoor 
gris, marron

30,8x61,5 cm NS / 12"x24" NS
30,8x61,5 cm NS - outdoor /
12"x24" NS - outdoor -

NS NATURALE STRUTTURATO
NATURAL TEXTURED **RS** RETTIFICATO/STRUTTURATO
RECTIFIED/TEXTURED



BLANC



GRIS



TAUPE



MARRON



floor: Blanc 61,0x61,0 cm . 24"x24" RS
wall: Blanc e Gris 30,8x61,5 cm . 12"x24" NS



floor: Blanc 61,0x61,0 cm . 24"x24" RS
wall: Blanc e Gris 30,8x61,5 cm . 12"x24" NS



blanc

90x90 cm 36"x36"	RS	A222
61,0x61,0 cm 24"x24"	RS	A195
30,8x61,5 cm 12"x24"	NS	A144



gris

90x90 cm 36"x36"	RS	A222
61,0x61,0 cm 24"x24"	RS	A195
30,8x61,5 cm 12"x24"	NS	A144
30,8x61,5 cm 12"x24" OUTDOOR	NS	A145



taupe

90x90 cm 36"x36"	RS	A222
61,0x61,0 cm 24"x24"	RS	A195
30,8x61,5 cm 12"x24"	NS	A144



marron

90x90 cm 36"x36"	RS	A222
61,0x61,0 cm 24"x24"	RS	A195
30,8x61,5 cm 12"x24"	NS	A144
30,8x61,5 cm 12"x24" OUTDOOR	NS	A145

decori - decors - décors - dekors

mosaico mix 36 tessere 5x5 - 30x30 cm 12"x12" **P71**  7

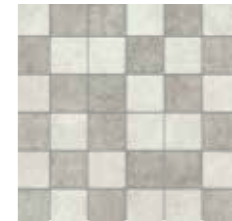

blanc/gris



taupe/marron

pezzi speciali - special pieces - pièces spéciales - formteile

elemento "L" monolitico outdoor
15x61x4 cm 6"x24"x1 3/4" **P51**  2



marron



gris

battiscopa
6,5x61,0 cm 2 1/2"x24" **P10**  12



blanc



gris



taupe



marron

step
30,8x61,5 cm 12"x24" **NS** **P92**

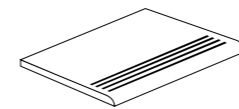

blanc

gris

taupe

marron

gradino costa retta
34x61,0x4 cm 13"x24"x1 3/4" **RS** **P31**

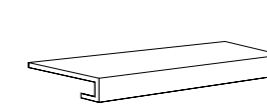

blanc

gris

taupe

marron

angolare costa retta dx/sx
34x34x4 cm 13"x13"x1 3/4" **RS** **P40**

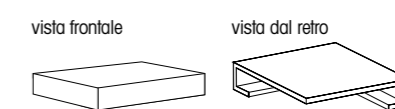

blanc

gris

taupe

marron

Note - Notes - Notes - Anmerkungen
I battiscopa e gli elementi "L" vengono venduti a pz. e a scatola completa. Tutti gli altri pezzi speciali vengono venduti al pezzo. I gradini vengono prodotti solo su ordinazione (tempo minimo di consegna 20 gg lavorativi).
All skirting and monolithic L elements, priced per piece, are sold in full box. All other special trims are sold by piece. Steps are produced only on request (minimum delivery terms of 20 days).
Les plinthes et élément "L" sont vendues la pièce et par boîte complète. Les autres pièces spéciales sont vendus la pièce. Le plat de marche sont produit sur demande (délai minimum de 20 jours).
Die Sockelleisten und Stufen werden pro Stk. und Vollen Kartons verkauft. Stufen und Stufenecken werden nur auf Bestellung produziert (Lieferzeiten mindesten 20 arbeitstagen ab Auftragserteilung).

effetto cemento
concrete-look
effet ciment
zementoptik

grès porcellanato impasto colorato
color body porcelain stoneware . grès cérame coloré dans la masse . durchgefärbtes feinsteinzeug



Formati Sizes - Formats - Formate

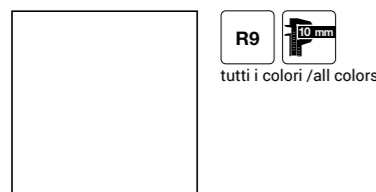

61,0x61,0 cm R / 24"x24" R



30,8x61,5 cm N / 12"x24" N



45,5x45,5 cm N / 18"x18" N

Colori Colours - Couleurs - Farbe

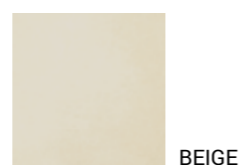

grey

61,0x61,0 cm 24"x24" R **A195**

45,5x45,5 cm 18"x18" N **A160**

30,8x61,5 cm 12"x24" N **A144**



black

61,0x61,0 cm 24"x24" R **A195**

45,5x45,5 cm 18"x18" N **A160**

30,8x61,5 cm 12"x24" N **A144**

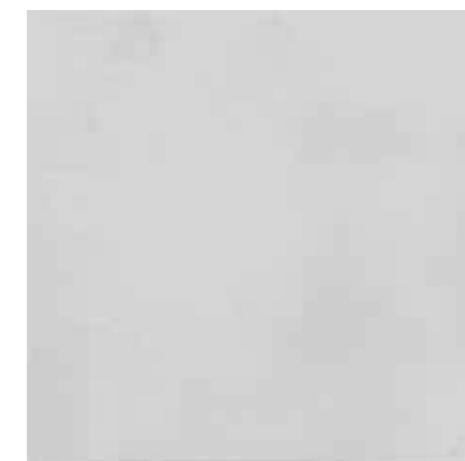

beige

61,0x61,0 cm 24"x24" R **A195**

45,5x45,5 cm 18"x18" N **A160**

30,8x61,5 cm 12"x24" N **A144**

pezzi speciali - special pieces - pièces spéciales - formteile

step
30,8x61,5 cm 12"x24" N **P92**
45,5x45,5 cm 18"x18" N **P93**

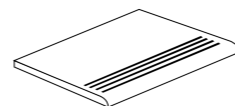

beige
grey
black

gradino costa retta
34x61,0x4 cm 13"x24"x1^{3/4}" R **P31**
34x45,5x4 cm 13"x18"x1^{3/4}" N **P30**

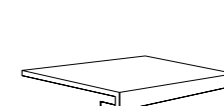

beige
grey
black

angolare costa retta dx/sx
34x34x4 cm 13"x13"x1^{3/4}" R **P40**
34x34x4 cm 13"x13"x1^{3/4}" N **P40**

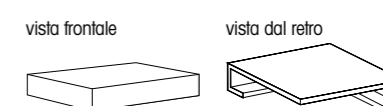

beige
grey
black

battiscopa
7,5x45,5 cm 3"x18" N **P09**  20



black

Note - Notes - Notes - Anmerkungen
I battiscopa vengono venduti a pz. e a scatola completa. Tutti gli altri pezzi speciali vengono venduti al pezzo. I gradini vengono prodotti solo su ordinazione (tempo minimo di consegna 20 gg lavorativi).
Skirtings are sold by piece and full boxes. All other special trims are sold by piece. Steps are produced only on request (minimum delivery terms of 20 days).
Les plinthes sont vendues la pièce et par boîte complète. Les autres pièces spéciales sont vendus la pièce. Le plat de marche sont produit sur demande (délai minimum de 20 jours).
Die Sockelleisten werden pro Stk. und Vollen Kartons verkauft. Stufen und Stufenecken werden nur auf Bestellung produziert (Lieferzeiten mindesten 20 arbeitstagen ab Auftragserteilung).

DEVON

 EASY COLLECTION

effetto legno
wood-look
effet bois
holzoptik

grès porcellanato
porcelain stoneware . grès cérame . feinsteinzeug

Formati
Sizes - Formats - Formate



20,3x122,6 cm R / 8"x48" R



tutti i colori / all colors

Colori
Colours - Couleurs - Farbe



ALMOND



BEIGE



WHITE



GREY

R RETTIFICATO
RECTIFIED



Almond
20,3x122,6 cm . 8"x48" R



Beige
20,3x122,6 cm . 8"x48" R



almond

20,3x122,6 cm 8"x48"

R **A32**



white

20,3x122,6 cm 8"x48"

R **A32**



beige

20,3x122,6 cm 8"x48"

R **A32**



grey

20,3x122,6 cm 8"x48"

R **A32**

pezzi speciali - special pieces - pièces spéciales - formteile

battiscopa
6,5x122,6 cm 2 1/2"x48" **R** **P05**  10



beige



almond



white



grey

gradino costa retta
34x122,6x4 cm 13"x48"x1 3/4" **R** **P32**

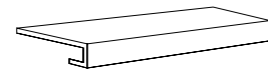

beige

almond

white

grey

angolare costa retta dx/sx
34x122,6x4 cm 13"x48"x1 3/4" **R** **P41**

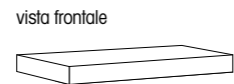

vista frontale

vista dal retro

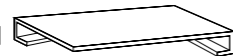

beige

almond

white

grey

sviluppo grafico - design development - développement graphique - grafische entwicklung 20,3x122,6 cm . 8"x48" R
(24 grafiche diverse . 24 different design . 24 graphiques différents . 24 verschiedene Grafische)



almond



beige



white



grey

Note - Notes - Notes - Anmerkungen
I battiscopa vengono venduti a pz. e a scatola completa. Tutti gli altri pezzi speciali vengono venduti al pezzo. I gradini vengono prodotti solo su ordinazione (tempo minimo di consegna 20 gg lavorativi).
Skirlings are sold by piece and full boxes. All other special trims are sold by piece. Steps are produced only on request (minimum delivery terms of 20 days).
Les plinthes sont vendues la pièce et par boîte complète. Les autres pièces spéciales sont vendus la pièce. Le plat de marche sont produit sur demande (délai minimum de 20 jours).
Die Sockelleisten werden pro Stk. und Vollen Kartons verkauft. Stufen und Stufenecken werden nur auf Bestellung produziert (Lieferzeiten mindesten 20 arbeitstagen ab Auftragserteilung).

WOODY FLOOR



effetto legno
wood-look
effet bois
holzoptik

grès porcellanato
porcelain stoneware . grès cérame . feinsteinzeug



Formati
Sizes - Formats - Formate

tutti i colori / all colors
 grigio, beige
 15x61 cm R / 6"x24" R
 15x61 cm R - outdoor / 6"x24" R - outdoor

Colori
Colours - Couleurs - Farbe



R RETTIFICATO
RECTIFIED



Beige
15x61 cm . 6"x24" R - 15x61 cm R . 6"x24" R outdoor



WOODY FLOOR



avorio
15x61 cm 6"x24"



grigio
15x61 cm 6"x24"
15x61 cm 6"x24" OUTDOOR



beige
15x61 cm 6"x24"
15x61 cm 6"x24" OUTDOOR



noce
15x61 cm 6"x24"

pezzi speciali - special pieces - pièces spéciales - formteile

step
30,4x61,0 cm 12"x24"

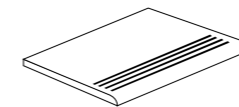

avorio
grigio
beige
noce

elemento "L" monolitico outdoor
15x30x4 cm 6"x12"x1 3/4" 4

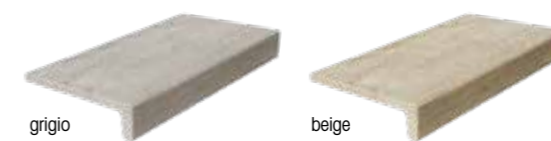

battiscopa
7,5x61,0 cm 3"x24" 12



Note - Notes - Notes - Anmerkungen
I battiscopa e gli elementi "L" vengono venduti a pz. e a scatola completa. Tutti gli altri pezzi speciali vengono venduti al pezzo. I gradini vengono prodotti solo su ordinazione (tempo minimo di consegna 20 gg lavorativi).
All skirting and monolithic L elements, priced per piece, are sold in full box. All other special trims are sold by piece. Steps are produced only on request (minimum delivery terms of 20 days).
Les plinthes et élément "L" sont vendues la pièce et par boîte complète. Les autres pièces spéciales sont vendus la pièce. Le plat de marche sont produit sur demande (délai minimum de 20 jours).
Die Sockelleisten und Stufen werden pro Stk. und Vollen Kartons verkauft. Stufen und Stufenecken werden nur auf Bestellung produziert (Lieferzeiten mindesten 20 arbeitstagen ab Auftragserteilung).

effetto marmo
marble-look
effet marbre
marmoroptik

grès porcellanato
porcelain stoneware . grès cérame . feinsteinzeug



Formati Sizes - Formats - Formate



45,5x45,5 cm N / 18"x18" N



Colori Colours - Couleurs - Farbe



beige
45,5x45,5 cm 18"x18"



grigio
45,5x45,5 cm 18"x18"



Beige
45,5x45,5 cm . 18"x18" N

pezzi speciali - special pieces - pièces spéciales - formteile

step
45,5x45,5 cm 18x18"

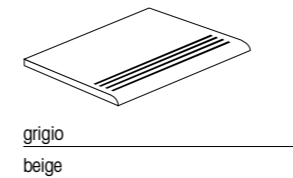

gradino costa retta
34x45,5x4 cm 13"x18"x1^{3/4}"

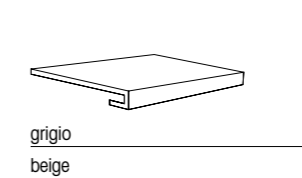

angolare costa retta dx/sx
34x34x4 cm 13"x13"x1^{3/4}"

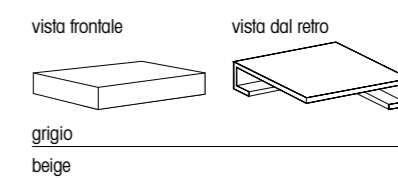

battiscopa
7,5x45,5 cm 3"x18" 20



Note - Notes - Notes - Anmerkungen
I battiscopa vengono venduti a pz. e a scatola completa. Tutti gli altri pezzi speciali vengono venduti al pezzo. I gradini vengono prodotti solo su ordinazione (tempo minimo di consegna 20 gg lavorativi).
Skirtings are sold by piece and full boxes. All other special trims are sold by piece. Steps are produced only on request (minimum delivery terms of 20 days).
Les plinthes sont vendues la pièce et par boîte complète. Les autres pièces spéciales sont vendus la pièce. Le plat de marche sont produit sur demande (délai minimum de 20 jours).
Die Sockelleisten werden pro Stk. und Vollen Kartons verkauft. Stufen und Stufenecken werden nur auf Bestellung produziert (Lieferzeiten mindesten 20 arbeitstagen ab Auftragserteilung).

effetto marmo
marble-look
effet marbre
marmoroptik

grès porcellanato
porcelain stoneware . grès cérame . feinsteinzeug



Formati
Sizes - Formats - Formate

Colori
Colours - Couleurs - Farbe



30,8x61,5 cm N / 12"x24" N

N NATURALE
NATURAL

ALMOND



BEIGE



almond

30,8x61,5 cm 12"x24"

N **A144**



beige

30,8x61,5 cm 12"x24"

N **A144**



Beige
30,8x61,5 cm . 12"x24" N

pezzi speciali - special pieces - pièces spéciales - formteile

step
30,8x61,5 cm 12"x24" **N** **P92**

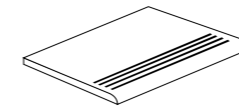

almond
beige

gradino costa retta
30,8x61,5x4 cm 12"x24"x1 3/4" **N** **P31**

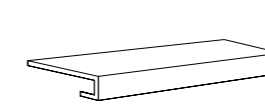

almond
beige

angolare costa retta dx/sx
30,8x30,8x4 cm 12"x12"x1 3/4" **N** **P40**

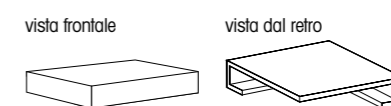

almond
beige

battiscopa
7,5x61,5 cm 3"x24" **N** **P10**  12



almond
beige

Note - Notes - Notes - Anmerkungen
I battiscopa vengono venduti a pz. e a scatola completa. Tutti gli altri pezzi speciali vengono venduti al pezzo. I gradini vengono prodotti solo su ordinazione (tempo minimo di consegna 20 gg lavorativi).
Skirtings are sold by piece and full boxes. All other special trims are sold by piece. Steps are produced only on request (minimum delivery terms of 20 days).
Les plinthes sont vendues la pièce et par boîte complète. Les autres pièces spéciales sont vendus la pièce. Le plat de marche sont produit sur demande (délai minimum de 20 jours).
Die Sockelleisten werden pro Stk. und Vollen Kartons verkauft. Stufen und Stufenecken werden nur auf Bestellung produziert (Lieferzeiten mindesten 20 arbeitstagen ab Auftragserteilung).

Sezione tecnica

Technical section
Section technique
Technischen Teil













- simbologia caratteristiche tecniche** 224
symboles technical characteristics
symboles des caracteristiques techniques
symbole technischen eigenschaften
- coefficiente di attrito (scivolosità)** 225
coefficient of friction (slipperiness)
coefficient de frottement (antidérapant)
rutschfestigkeit
- consigli di posa** 226
laying recommendations
conseils de pose
ratschläge für die verlegung
- consigli per la stuccatura e la pulizia dopo posa** 227
recommendations for grouting and cleaning after installation
conseils pour le stucage et le nettoyage après la pose
ratschläge für die verfugung und erste reinigung nach der verlegung
- pulizia e manutenzione dei prodotti Il Cavallino** 228
cleaning and care of Il Cavallino products
nettoyage et entretien des articles Il Cavallino
reinigung und pflege der produkte von Il Cavallino
- avvertenze** 232
warning instructions
instructions
hinweise
- legenda** 234
legend
légend
zeichenerklärung
- condizioni generali di vendita** 235
general conditions of sale
conditions générales de vente
allgemeine verkaufsbedingungen
- tabella pesi ed imballi** 236
sizes weight and packaging
mesures poids et emballages
tabelle der gewichte und verpackungen



IL CAVALLINO
CERAMICHE since 1968

sezione tecnica
technical section
section technique
technischen Teil

simbologia caratteristica tecniche - grès porcellanato smaltato . symboles technical characteristics - grès porcellanato smaltato . symboles des caractéristiques techniques - grès cérame émaillé . symbole technischen eigenschaften - glasiertes feinsteinzeug

		CARATTERISTICHE TECNICHE TECHNICAL CHARACTERISTICS CARACTÉRISTIQUES TECHNIQUES TECHNISCHE MERKMALE	NORMA DI RIFERIMENTO REFERENCE STANDARD NORME DE REFERENCE PRÜFMETHODE	VALORE RICHIESTO REQUIRED VALUE VALEUR REQUISE SOLLWERT	VALORE MEDIO IL CAVALLINO AV. IL CAVALLINO VALUE VALEUR MOYENNE IL CAVALLINO MITTLERER IL CAVALLINO-WERT		
	DIMENSIONI DIMENSIONS DIMENSIONS ABMESSUNGEN		ISO 10545-2	CONFORME COMPLIANT CONFORME KONFORM	CONFORME COMPLIANT CONFORME KONFORM		
	ASSORBIMENTO D'ACQUA WATER ABSORPTION ABSORPTION D'EAU WASSERAUFNAHME		ISO 10545-3	≤ 0,5 %	CONFORME COMPLIANT CONFORME KONFORM		
	RESISTENZA A FLESSIONE MODULUS OF RUPTURE RESISTANCE A LA FLEXION BIEGEFESTIGKEIT		ISO 10545-4	MODULUS OF RUPTURE R ≥ 35 N/MM ² BREAKING STRENGTH S ≥ 1300 N	CONFORME COMPLIANT CONFORME KONFORM		
	RESISTENZA ALL'ABRASIONE ABRASION RESISTANCE RÉSISTANCE À L'ABRASION ABRIEBBESTÄNDIGKEIT		ISO 10545-7	PEI SOLO PER PIASTRELLE SMALTATE ONLY FOR GLAZED TILES			
	DILATAZIONE TERMICA LINEARE LINEAR THERMAL EXPANSION DILATATION THERMIQUE LINEAIRE LINEARE WÄRMEAUDEHNUNG		ISO 10545-8	≤ 9x10 ⁻⁵ °C ⁻¹	CONFORME COMPLIANT CONFORME KONFORM		
	RESISTENZA AGLI SBALZI TERMICI THERMAL SHOCK RESISTANCE RESISTANCE AUX ECARTS DE TEMPERATURE ITEMPERATURWECHSELBESTÄNDIGKEIT		ISO 10545-9	RESISTENTE RESISTANT RESISTANT BESTÄNDIG	RESISTENTE RESISTANT RESISTANT BESTÄNDIG		
	RESISTENZA AL GELO FROST RESISTANCE RESISTANCE AU GEL FROSTBESTÄNDIGKEIT		ISO 10545-12	RESISTENTE RESISTANT RESISTANT BESTÄNDIG	RESISTENTE RESISTANT RESISTANT BESTÄNDIG		
	RESISTENZA AGLI ACIDI ED ALLE BASI ACID AND ALKALI RESISTANCE RESISTANCE AUX ACIDES ET AUX BASES SÄURE- UND LAUGENBESTÄNDIGKEIT		ISO 10545-13	CLASS GB MIN.	LOW CONCENTRATION GLA HIGH CONCENTRATION GHA		
	RESISTENZA ALL'ATTACCO CHIMICO CHEMICAL RESISTANCE RESISTANCE À L'ATTAQUE CHEMIQUE CHEMISCHE BESTÄNDIGKEIT		ISO 10545-13	CLASS GB MIN.	GA		
	RESISTENZA ALLE MACCHIE STAIN RESISTANCE RESISTANCE AU TACHES FLECKENBESTÄNDIGKEIT		ISO 10545-14	CLASS 3 MIN.	5		
	COEFFICIENTE DI ATTRITO (SCIVOLosità) FRICTION COEFFICIENT (SLIPPERINESS) COEFFICIENT DE FRICTION (GLISSEMENT) REIBUNGSKOEFFIZIENT (RUTSCHIGKEIT)	BCR - ITALIA DM DEL 14-06-89		ASTM - USA ASTM C1028	DIN - GERMANIA DIN 51130		
		DRY RUBBER 0,62	WET RUBBER 0,51	DRY LEATHER 0,62	DRY NEOLYTHE 0,69	WET NEOLYTHE 0,62	R9-R12 ZH 1/571
<p>THE PRODUCTS HAVING AN ABSORPTION < 0,5% ARE CLASSIFIED ACCORDING THE UNI CEN STANDARDS "FULLY VITRIFIED TILES" AND ACCORDING TO THE ASTM STANDARDS "IMPERVIOUS TILES"</p>							

coefficiente di attrito (scivolosità) - grès porcellanato . coefficient of friction (slipperiness) - porcelain stoneware . coefficient de frottement (antidérapant) - grès cérame . rutschfestigkeit - feinsteinzeug

La scivolosità di un pavimento è legata alla sicurezza della deambulazione e rappresenta, pertanto, un requisito fondamentale del pavimento stesso. Il coefficiente di scivolosità, indicato dal valore "R", si riferisce ad un metodo previsto dalle norme tedesche DIN 51130 e 51097, che classificano i prodotti in base al loro coefficiente d'attrito, in funzione delle esigenze specifiche di un determinato ambiente.

A seconda del livello di scivolosità, che può essere legato all'uso di particolari sostanze in determinati spazi di lavoro, o alla presenza di acqua, è obbligatorio, in base alla normativa, l'impiego di un materiale a pavimento in grado di creare un notevole attrito tra le superfici a contatto, capace quindi di limitare la pericolosità dello stesso per le persone. Quanto più alto è il coefficiente d'attrito, tanto minore è la scivolosità.

La normativa distingue la scivolosità delle superfici calpestabili per le zone ove si cammini con piedi calzati (R9-R13), e per quelle a calpestio a piedi nudi (A,B,C). Secondo il metodo di misura previsto dalla DIN 51130, vengono distinte le seguenti classi di scivolosità e le indicazioni dei rispettivi ambienti di utilizzo:

- R9 - zone di ingresso e scale con accesso all'esterno; ristoranti e mense; negozi; ambulatori; ospedali; scuole.
- R10 - bagni e docce comuni; piccole cucine di esercizi per la ristorazione; garage e sotterranei.
- R11 - ambienti per la produzione di generi alimentari; medie cucine di esercizi per la ristorazione; ambienti di lavorazione con forte presenza di acqua e fanghiglia; laboratori; lavanderia; hangar.
- R12 - ambienti per la produzione di alimentari ricchi di grassi come latticini e derivati; olio e salumi; grandi cucine di esercizi per la ristorazione; reparti industriali con impiego di sostanze scivolose; parcheggi auto.
- R13 - ambienti con grosse quantità di grassi; lavorazione degli alimenti.

Per gli ambienti in presenza d'acqua, dove sia prevista la deambulazione a piedi scalzi, il pavimento deve rispondere con prestazioni ancora più restrittive. Queste si possono misurare in base alla normativa DIN 51097, e si classificano nei gruppi di valutazione A, B, C secondo un valore crescente:

- A - spogliatoi; zone di accesso a piedi nudi; etc.
- B - docce; bordi di piscine; etc.
- C - bordi di piscine in pendenza, scale immerse; etc.

The slipperiness of a floor relates to how safe it is to walk on and, for this reason, is a fundamental feature of the floor itself. Slipperiness is indicated by the R-value, which refers to a method required by the German DIN 51130 and 51097 standards, which classify products based on their coefficient of friction, as a function of the specific needs of a certain space. Depending on the level of slipperiness, which could be linked to the use of specific substances in certain work areas, or the presence of water, the standards require the use of flooring materials capable of creating a significant level of friction between contact surfaces to limit its danger for people. The greater the coefficient of friction, the lower its slipperiness.

The standard distinguishes the slipperiness of treadable surfaces between areas where one walks wearing shoes (R9-R13) and those where one walks barefoot (A, B and C). The measurement method required by the DIN 51130 standard defines the following slipperiness classes and indicates their respective environments of use:

- R9 - entrance areas and stairs with access to the outside, restaurants and cafeterias, stores, clinics, hospitals and schools.
- R10 - common bathrooms and showers, small kitchens in foodservice businesses, garages and cellars.
- R11 - food-production areas, medium-sized kitchens in foodservice businesses, processing environments with a high presence of water and sludge, workshops, laundries and hangars.
- R12 - areas for the production of fatty foods such as dairy products and derivatives, oils and deli meats, large kitchens in foodservice businesses, industrial departments where slippery substances are used and parking lots.
- R13 - areas with large quantities of fats and food processing.

For wet areas where people will be walking barefoot, the floor must meet even stricter requirements. These can be measured based on the DIN 51097 standard and are classed in groups A, B, C with increasing values:

- A - locker rooms, areas where people go barefoot, etc.
- B - showers, swimming pool sides, etc.
- C - sloping swimming pool sides, submerged ladders, etc.

Pouvoir marcher en toute sécurité sur un revêtement de sol est lié à la qualité antidérapante qu'il offre, ce qui fait de cette qualité une condition essentielle. Le coefficient de frottement, indiqué par la valeur "R", se réfère à des méthodes normatives allemandes DIN 51130 et 51097, qui classent les produits par rapport à leurs coefficients de frottement et en fonction des exigences spécifiques liées à l'espace équipé.

Selon le degré antidérapant requis qui dépend de l'utilisation de substances particulières dans certains espaces de travail ou de la présence d'eau, il est obligatoire conformément à la réglementation d'utiliser un revêtement de sol en mesure de créer un coefficient de frottement important entre les surfaces en contact, et donc de limiter le danger de glissade pour les personnes. Plus le coefficient de frottement est élevé, plus le danger de glissade est réduit.

La réglementation distingue les surfaces antidérapantes praticables chaussures aux pieds (R9-R13) de celles praticables pieds nus (A,B,C).

Selon la méthode de mesure par la norme DIN 51130, on définit plusieurs classifications de surfaces antidérapantes et leurs caractéristiques, comme suit zones d'utilisation:

- R9 - entrées et escaliers avec accès sur l'extérieur; restaurants et cantines; magasins; chirurgie ambulatoire; hôpitaux; écoles.
- R10 - salles de bain et douches communes; petites cuisines d'entreprise; garage et souterrains.
- R11 - zones dédiées à la production alimentaire; petites cuisines d'entreprise; environnements professionnels avec une forte présence d'eau et de boue; laboratoires; laveries; hangars.
- R12 - zones dédiées à la production alimentaire riches en matières grasses comme les laitages et produits dérivés; producteurs d'huiles et charcuteries; grandes cuisines d'entreprise; services industriels utilisant des substances glissantes; parking automobiles.
- R13 - zones dédiées à de grandes quantités de matières grasses; traitement des aliments.

Pour les zones où la présence d'eau et la marche pieds nus sont inévitables, le revêtement de sol doit répondre à des conditions encore plus restrictives. Ces restrictions se mesurent conformément à la norme DIN 51097 et sont classifiées dans des groupes d'évaluation A, B, C dans un ordre croissant:

- A - vestiaires; zones accessibles pieds nus; etc.
- B - douches; bords de piscines; etc.
- C - bords de piscines en pente, escaliers immergés; etc.

Die Rutschfestigkeit eines Fußbodens ist eng mit der Gehsicherheit verbunden und stellt demnach eine grundlegende Voraussetzung für die Fußböden selbst dar. Der Rutschfestigkeitskoeffizient, der mit dem Wert "R" angezeigt ist, bezieht sich auf eine von den deutschen Richtlinien DIN 51130 und 5107 vorgesehene Methode. Diese Richtlinien klassifizieren die Produkte nach ihrer Rutschfestigkeit, je nach den spezifischen Anforderungen eines bestimmten Ambiente.

Je nach dem Grad der Rutschigkeit, die von der Verwendung von besonderen Substanzen in bestimmten Arbeitsbereichen oder von dem Vorkommen von Wasser abhängig sein kann, muss gemäß der Richtlinie ein Fußbodenmaterial eingesetzt werden, das zwischen den Kontaktflächen eine hohe Rutschfestigkeit garantiert und demnach die Rutschgefahr für Personen einschränkt. Je höher der Rutschfestigkeitskoeffizient, desto geringer ist die Rutschgefahr.

Die Richtlinie unterscheidet zwischen den Flächen für Bereiche, die mit Schuhwerk begangen werden (R9-R13), und den Flächen, die barfuß genutzt werden (A,B,C).





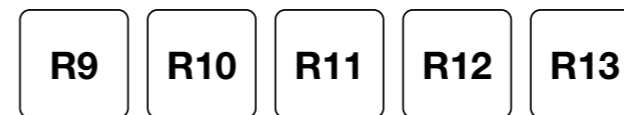

Gemäß der von der Richtlinie DIN 51130 vorgesehene Messmethode werden die folgenden Rutschfestigkeitsklassen und die Anweisungen der entsprechenden Räumlichkeiten unterschieden:

- R9 - Eingangs- und Treppenbereiche mit direktem Zugang zum Außenbereich; Restaurants und Kantinen; Geschäfte; Praxen; Krankenhäuser; Schulen.
- R10 - Gemeinschaftsbäder und -duschen; kleine Betriebsküchen im Gastronomiebereich; Garagen und Keller.
- R11 - Bereiche für die Lebensmittelproduktion; mittelgroße Betriebsküchen im Gastronomiebereich; Verarbeitungsbereiche mit starkem Wasser- und Schlammvorkommen; Labors; Wäschereien; Flugzeughallen.
- R12 - Bereiche für die Produktion von fetten Lebensmitteln, wie Milchprodukte und Folgeprodukte; Öl und Wurstwaren; große Betriebsküchen im Gastronomiebereich; Industrieabteilungen, in den schmierige Substanzen verwendet werden; Parkplätze.
- R13 - Bereiche, die fettigen Stoffen ausgesetzt sind; Lebensmittelverarbeitung.

In barfuß genutzten Räumlichkeiten mit hohem Wasservorkommen muss der Fußboden noch strengeren Einschränkungen unterzogen werden. Diese können je nach der Richtlinie DIN 51097 berechnet und mit zunehmendem Wert in die Bewertungsgruppen A, B, C unterteilt werden:

- A - Umkleideräume; barfuß zu begehende Eingangsbereiche; etc.
- B - Duschräume; Schwimmbeckenränder; etc.
- C - Geneigte Schwimmbeckenränder, Unterwasserstufen; etc.



angolo angle . inclinaison . winkel	classificazione classification . classification bewertungsgruppe	destinazione d'uso intended use . utilisation prévue . bestimmungszweck
 α < 6°	Non classificato Unclassified Non classé Nicht bewerte	
 6° ≤ α ≤ 10°	R 9	Zone ingresso e scale con accesso dall'esterno. Ristoranti e mense, negozi, ambulatori, ospedali, scuole. Entrances and staircases with outdoor access. Restaurants and canteens, shops, clinics, hospitals, school. Zones d'entrée et escaliers avec accès de l'extérieur. Restaurants et cantines, magasins, cabinets de consultation, hôpitaux et écoles.
 10° ≤ α ≤ 19°	R 10	Bagni e docce comuni, piccole cucine ed esercizi per la ristorazione, garage e sotterranei. Communal bathrooms and showers, small kitchens and catering outlets, garages and basements. Toilettes et douches communes, petites cuisines pour l'exercice de la restauration, garages et sous-sols. Badezimmer und Gemeinschaftsduschen, kleine Küchen und Betriebe für die Restauration, Garagen und Untergeschoße.
 19° ≤ α ≤ 27°	R 11	Ambienti per la produzione di generi alimentari. Medie cucine di esercizi per la ristorazione. Food production facilities. Medium-sized restaurant kitchens. Working environments with large amounts of water and mud, laboratories, laundries and hangars. Locaux pour la production de denrées alimentaires. Cuisines de dimensions moyennes pour l'exercice de la restauration. Lieux de travail avec forte présence d'eau et de boue, laboratoires, teintureries et hangars. Arbeitsbereiche mit stark vorhandenem Wasser und Schlamm, Labors, Wäschereien, Hangars.
 27° ≤ α ≤ 35°	R 12	Ambienti per la produzione di alimenti ricchi di grassi come latticini e derivati, olii e salumi. Grandi cucine per la ristorazione. Preparati industriali con impiego di sostanze scivolose. Parcheggi auto. Environments for the production of high-fat foods such as dairy products, oils and cured meats. Large restaurant kitchens. Industrial facilities making products using slippery substances. Car parks. Locaux pour la production de denrées alimentaires riches en matières grasses telles que charcuteries et huiles. Grandes cuisines pour l'exercice de la restauration. Ateliers industriels avec emploi de substances glissantes. Parcs de stationnement autos. Bereiche für die Produktion fettreicher Lebensmittel wie Milchprodukte und milchnebenprodukte, Öle und Wurstwaren. Großküchen für die Restauration. Industrielle Zubereitungen mit Einsatz rutschiger Stoffe. Autoparkplätze.
 α ≥ 35°	R 13	Ambienti con grossa quantità di grassi. Lavorazione degli alimenti. Environments with large quantities of fats and grease. Food processing. Locaux avec grande quantité de grasses. Locaux de transformation des aliments. Bereiche mit großen Fettmengen. Lebensmittelbearbeitung.

consigli di posa - grès porcellanato . laying recommendations - porcelain stoneware

Di seguito indichiamo alcuni consigli per valorizzare le caratteristiche dei nostri prodotti in fase di posa. In preparazione alla posa, si raccomanda di controllare il tono, il calibro e la scelta. L'utilizzo di materiale diverso da quello ordinato o difettoso significa l'accettazione delle caratteristiche qualitative ed esclude contestazioni. Non saranno accettati reclami su materiale già posato con difetti visibili prima della posa.

Il nostro materiale è deliberatamente prodotto e scelto con leggere differenze di tonalità che esaltano gli effetti delle grafiche e dei colori. Un accorgimento basilare per la posa del nostro prodotto è quello di alternare con cura le differenti tonalità prelevando le piastrelle a gruppi di 3 o 4 per volta da almeno cinque scatole diverse, in particolare per l'utilizzo di serie con un grado di stonalizzazione e miscelazione cromatica uguale o superiore al valore V2. Raccomandiamo di disporre le venature delle piastrelle in modo da ottenere il migliore effetto estetico e cromatico distribuendo in modo armonioso le diverse nuance di colore che si evidenziano controllando il risultato di tanto di tanto, osservando da opportuna distanza una porzione di lavoro eseguita. Durante le operazioni di posa, soprattutto nella posa a formati misti, adottare una fuga minima di 7 mm.

Per la posa di materiali rettificati è comunque sempre indispensabile mantenere una fuga minima di 2/3 mm da una piastrella all'altra usufruendo di stucchi e sigillanti di colore coordinato a quello del materiale. Nella posa di materiali rettificati rettangolari, è importante evitare di far collimare i vertici di una piastrella con la metà delle altre, al fine di sopprime alle eventuali imperfezioni di planarità presenti comunque in tutti i grandi formati. Trattandosi di materiale tagliato e rettificato, per evitare questo problema, è consigliabile posare il materiale a corere, con intervallo da 6 a 15 cm tra ogni piastrella come da schema sotto riportato (v. disegno). È fortemente auspicabile affidare la posa a personale esperto che, dopo aver verificato la corretta planarità della caldana e la qualità del materiale, contribuirà alla impeccabile esecuzione dell'incarico.

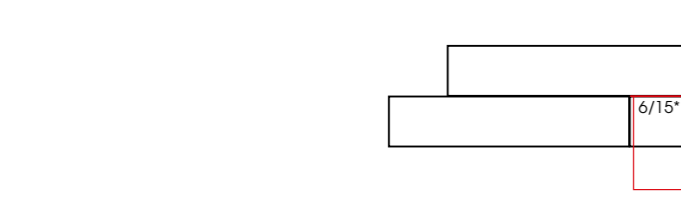

Per quanto riguarda la posa all'esterno è opportuno seguire accuratamente alcuni accorgimenti:

- Suddivisione della pavimentazione in "maglie" di superficie ridotta, mediante giunti di dilatazione; si consiglia, ogni 5/10 mq, di posizionare il giunto seguendo le più probabili linee di scarico delle tensioni da dilatazione termiche.
- Creare opportuni drenaggi nel sottofondo nonché pendenza (almeno 1%) e planarità della superficie onde evitare il ristagno dell'acqua sia nel sottofondo che in superficie.
- Il massetto deve essere gettato su uno strato impermeabilizzante, di uno spessore di almeno 5 cm.
- Prima della posa assicurarsi che non permangano zone a grossa infiltrazione di umidità, tubazioni e canalizzazioni siano ben protette e issate e siano terminati i lavori edili più grossi.
- Si devono utilizzare sia collanti che materiali per le fughe idonei alla posa all'esterno quindi idrorepellenti. La fuga non deve essere inferiore ai 7 mm.
- Per evitare infiltrazioni di acqua in corrispondenza delle stuccature sarebbe opportuno impregnare le stesse con liquido impermeabilizzante.

Consigliamo molta attenzione nell'uso di materiali fugganti in quanto i coloranti in essi contenuti possono macchiare le superfici smaltate. Durante la posa è necessario non segnare il materiale sulla superficie di utilizzo con matite (grafite) o pennarelli indelebili, in particolar modo per prodotti lappati. Sugeriamo infine di adattarsi al sistema di posa R.L.S. (Raimondi Levelling System) per il quale vi forniamo le seguenti indicazioni.

Il sistema R.L.S.

Il sistema R.L.S. rivoluziona il mondo della posa garantendo di ottenere con semplicità e rapidità pavimenti perfettamente livellati eliminando i dislivelli tra le piastrelle. R.L.S. è perfetto per grandi formati e piastrelle "ultrasottili" (3/5 mm).

R.L.S. è composto di 3 elementi: base, cuneo, pinza. Le basi sono disponibili in due diverse versioni: per piastrelle di spessore compreso tra i 3 e i 12 mm; le piastrelle di spessore compreso tra 12 e 20 mm. Il cuneo è unico per entrambi le basi ed è riutilizzabile infinite volte. La pinza regolabile è disponibile in versione per posa a pavimento e in versione per posa a rivestimento ed è consigliata per inserire con facilità i cunei nelle basi; ottimizzando al contempo la pressione esercitata sulla piastrella. La pinza è unica indipendentemente dallo spessore della piastrella.

COME SI USA

Posizionamento del supporto:

- Dopo aver steso l'adesivo inserire il supporto al di sotto delle piastrelle in corrispondenza dei 4 lati.
- In funzione del formato della piastrella posizionare uno o più supporti per ogni lato della piastrella.
- Posizionare la piastrella e batterla con martello in gomma.

Inserimento del cuneo:

- Inserire il cuneo nella feritoia del supporto facendo attenzione a non superare il punto di rottura.
- Per agevolare l'inserimento del cuneo si consiglia l'uso della pinza a trazione regolabile.

Eliminazione del supporto:

A maturazione avvenuta, la parte sporgente del supporto si separa dalla base battendo, nella direzione della linea di fuga, con un martello in gomma o col piede.

Per maggiori informazioni è disponibile un esaustivo video sul sistema R.L.S. nella sezione Video del sito: www.raimonditensili.it

Raimondi . Via dei Tipografi, 11 - 41122 Modena (Italy) - Tel. +39 059 280 888 / Fax +39 059 282 808 www.raimonditensili.it - raiutens@raimonditensili.it



Avvertenze

Lavaggio e pulizia dopo posa

Il lavaggio dopo posa è una fase di fondamentale importanza per tutti gli interventi successivi e per la manutenzione. La rimozione inadeguata o tardiva dei residui della stuccatura utilizzata per le fughe, può lasciare alonature difficili da rimuovere e creare sulla pavimentazione un film cementizio capace di assorbire ogni forma di sporco, dando così l'impressione che sia il materiale a sporcarsi.

Con il lavaggio dopo posa:

- Si eliminano i residui di posa (malta, colla, vernice, sporco da cantiere di varia natura).
- Si rimuovono eventuali residui superficiali del materiale.

È bene sapere che oltre il 90% delle contestazioni in cantiere è dovuta ad un cattivo, o addirittura inesistente, lavaggio dopo posa.



- NON SI ACCETTANO CONTESTAZIONI PER MATERIALE POSATO
- CONTROLLARE TONO, CALIBRO, SCELTA E PLANARITA' PRIMA DELLA POSA DEL MATERIALE
- LE MACCHINE ELETTRONICHE CHE STABILISCONO IL CALIBRO SONO TARATE CON UNA TOLLERANZA DI 1,2 MM
- IL MATERIALE DEVE ESSERE POSATO CON UN MINIMO DI FUGA DI 3 MM. IL MATERIALE RETTIFICATO DEVE ESSERE POSATO CON UNA FUGA MINIMA DI 2 MM.

Le serie Terre Toscane e Camelot devono essere posate con una fuga di 5 mm.

Below, we provide some recommendations for enhancing the features of our products during laying. Before laying, we recommend that you check the colour, size and quality. The use of materials that are different than you ordered, or defective, indicates acceptance of the quality of the materials and rules out claims. We will not accept claims regarding installed materials with defects that were visible before laying.

Our materials are deliberately produced and selected with slight tonal variations that enhance the effects of the graphics and colours. On basic technique for installing our products is to carefully alternate different tones by picking tiles in groups of 3 or 4 from at least five different boxes and, especially, the use of series with a degree of tonal variation and chromatic mixing equal to, or greater than, a value of V2. We recommend that you orient the grain of the tiles to obtain the best aesthetic and chromatic effect by harmoniously distributing the different colour nuances that can be seen by checking the results from time to time, looking at a portion of the floor from a suitable distance. During laying and especially when laying mixed sizes, use minimum joint spacing of 7 mm. When installing rectified materials it is indispensable, in any case, to maintain a minimum joint space of 2-3 mm between tiles, using stuccos and sealants whose colour is coordinated with that of the material. When installing rectangular rectified materials, it is important to avoid placing the vertex of one tile near the middle of the others in order to compensate for any imperfections of planarity that are, in any case, present in all the large sizes. Since this is cut and rectified material, to avoid this problem, we recommend that you lay the material longitudinally, with a space of 6 to 15 cm between each tile, as shown below (see drawing). We strongly recommend that laying be performed by expert personnel who, after checking the correct planarity of the concrete slab and the quality of the material, will be able to install it in the best way possible.



As for an outside laying, we recommend that you carefully use several techniques:

- Divide the floor into "grids" of smaller surface areas using dilation joints; we recommend placing a joint every 5-10 m2 following the most probable lines for discharging the tensions of thermal dilations.
- Create suitable drainages in the foundation as well as a slope (of at least 1%) and a flat surface in order to avoid pools of water on both the foundation and the surface.
- The concrete slab must be cast on a waterproofing layer at least 5 cm thick.
- Before laying, make sure there are no areas with large infiltrations of humidity, that pipes and channels and well-protected and that the larger construction works have been completed.
- You must use mastics and grouts that are suitable for external use and, thus, waterproof. The joint space between tiles must not be less than 7 mm.
- To avoid water infiltrating the grout, it is a good idea to impregnate it with waterproofing liquid.

We recommend care in the use of grouts because their colourings can stain glazed surfaces. During laying, the surface of the material must not be marked with pencil (graphite) or indelible marker, especially honed products. Our recommendation is to follow the laying pattern R.L.S. (Raimondi Levelling System) for which we provide the following information.

R.L.S. System

Raimondi Levelling System (R.L.S.) is a revolution in the tile setting. In addition to ensuring the proper leveling of files, this system helps to speed up the file setting process. R.L.S. is strongly recommended when installing flexible, large format, heavy or low-thickness tiles (3/5 mm; 1/8"- 3/16").

R.L.S. is made up of three elements: clips (spacers), wedges and pliers. Clips are available in two different versions: for files from 3 up to 12 mm thickness (1/8" - 1/2"); for files from 12 up to 20 mm thickness (1/2" - 3/4"). The wedge works for both clip sizes and it is re-usable virtually forever. Special traction-adjustable pliers are available in two different versions: for floor or for wall coverings. The use of the pliers is suggested for facilitating and speeding up the insertion of the wedge in the clips. It also optimizes the pressure on the file. R.L.S. is the easiest and quickest to remove leveling system: it is enough to kick the spacers to remove the unnecessary part from the installed floor. No tool required.

HOW TO USE

How to set the support:

- After having spread the adhesive, insert the clip (base/support) underneath the tiles and along the 4 sides.
- According with files size, set one or more clips on every side of the tile.
- Set the tile and beat it with a rubber mallet.

How to insert the wedge:

- Insert the wedge in the clip (base) slot paying attention not to pass the breakpoint.
- To facilitate this operation, the use of the special traction-adjustable-pliers is recommended.

How to remove the support:

Once the adhesive is set, the protruding part of the support, has to be removed by separating it from the clip/base. This can be done with a rubber mallet or even with feet. Beat parallel to the joint.

For further info please watch the exhaustive video of the R.L.S. on web site: www.raimonditensili.it

Raimondi . Via dei Tipografi, 11 - 41122 Modena (Italy) - Tel. +39 059 280 888 / Fax +39 059 282 808 www.raimonditensili.it - raiutens@raimonditensili.it

1) NO CLAIMS WILL BE ACCEPTED FOR LAID MATERIALS

- CHECK THE SHADE, WORKSIZE, SELECTION AND THE WARPAGE BEFORE LAYING THE MATERIAL
- ELECTRONIC MACHINES THAT SET THE WORKSIZE ARE CALIBRATED WITH A TOLERANCE OF 1.2 MM
- THE MATERIAL MUST BE LAID WITH A MINIMUM JOINT OF 3 MM. THE RECTIFIED MATERIAL MUST BE LAID WITH A MINIMUM JOINT OF 2 MM.

The Terre Toscane e Camelot series (thin paving bricks) must be laid with a joint of 5 mm.

consigli per la stuccatura e la pulizia dopo posa

La pulizia finale dell'eventuale velo polveroso di stucco dalla superficie si esegue a completa stagionatura dello stucco cementizio (almeno 36-48 ore), eseguendo una pulizia con detergente acido applicabile a mano (spugna o stracci) oppure a macchina (monospazzola) attenendosi scrupolosamente ai consigli di seguito riportati.

1. Prodotti consigliati.

Si consiglia di utilizzare una soluzione acida ad azione tamponata, diluita 1:5

(1 litro in 5 di acqua calda) in acqua possibilmente calda

Quantità d'uso: 6 litri soluzione acida per 100m2.

Evitare assolutamente l'utilizzo di acidi da ferramenta diluiti (per il loro rilascio di fumi nocivi e per la loro azione "bruciante" nei confronti dei giunti).

2. Modalità di esecuzione.

a - Bagnare con acqua solamente lo stucco cementizio in modo da proteggerlo da una eventuale azione corrosiva della soluzione acida diluita;
b - Distribuire uniformemente la soluzione acida diluita utilizzando un normale mop-lavapavimenti (mocio) o uno straccio ruvido per ambienti residenziali oppure frizionando con monospazzola rotante per grandi superfici;
c - Lasciare agire per qualche minuto, in funzione dell'intensità dello sporco;
d - Intervenire energicamente con spugna commerciale scotch-brite o con lo spazzolone;
e - Raccogliere il residuo con stracci oppure con aspiraliquidi.
f - Risciacquare abbondantemente con acqua calda pulita, ripetendo l'operazione anche più volte sino alla eliminazione di qualsiasi alonatura o residuo negli interstizi.

Eseguire una precisa e corretta pulizia del prodotto ceramico è di fondamentale importanza per mantenerne nel tempo l'originaria lucentezza e bellezza. Si raccomanda pertanto di seguire con attenzione le indicazioni seguenti.

A) PULIZIA "DOPO-POSA" IN CANTIERE

Il lavaggio iniziale delle piastrelle nel "dopo-posa" in cantiere è una fase di fondamentale importanza.

È infatti in questo momento che è possibile rimuovere agevolmente dalle piastrelle tutti i residui dei materiali usati per la posa e/o della stuccatura delle fughe della piastrella stessa.

Si tratta di residui di varia natura che, se lasciati "asciugare e/o seccare" sulle piastrelle, soprattutto in quelle caratterizzate da una superficie strutturata più o meno accentuata potrebbero diventare difficili da rimuovere successivamente. Si raccomanda sempre la massima attenzione alla scelta dell'agente pulente per non alterare irrimediabilmente il grado di lucentezza e brillantezza della piastrella posata.

Pulizia del pavimento stuccato con "Stucchi cementizi a base d'acqua"

Come già accennato, con il lavaggio "dopo-posa" si rimuovono i residui di cemento, stucchi cementizi, salintri, colle ed eventuali residui superficiali del materiale di varia natura. In questa fase il pavimento deve essere lavato con detersivi a base di acidi tamponati entro almeno 3-4 giorni dopo la posa e mai oltre i 10 giorni.

NB: Per i prodotti caratterizzati da superfici strutturate e/o antiscivolo si raccomanda, viste le asperità della struttura, di sporcare il meno possibile la superficie della piastrella durante le fasi della posa e di pulire bene subito dopo la stuccatura gli eccessi di materiali utilizzati con una spugna bagnata in acqua pulita. Si raccomanda altresì di eseguire la procedura sotto-descritta il prima possibile e comunque prima dei su citati 3-4 giorni massimi dal "dopo-posa".

Procedere come segue:

- Preparare il detergente come indicato in etichetta (si consiglia di effettuare prove preliminari su piastrelle non posate per verificare l'inalterabilità della superficie della piastrella)
- Bagnare preventivamente il pavimento con acqua pulita
- Stendere la soluzione sulle piastrelle lasciando che agisca per qualche minuto
- Passare la monospazzola utilizzando dischi appropriati (verdi per le superfici strutturate e rosso per le non strutturate) o una paglietta (verde per le superfici strutturate e rossa/marrone per le non strutturate) strofinando energicamente la superficie delle piastrelle.
- Risciacquare abbondantemente con acqua pulita aspirando il liquido

PULIZIA FINE CANTIERE STUCCO CEMENTIZIO	TIPO DI DETERGENTE	PRODOTTO	PRODUTTORE
		CEMENT REMOVER	FABER CHIMICA
	Detergente acido	KERANET	MAPEI
		DERTERDEK	FILA

Pulizia del pavimento stuccato con "Stucchi epossidici"

Nel caso di utilizzo di stucchi epossidici, considerato che essi induriscono rapidamente in pochi minuti, il lavaggio "dopo-posa" deve essere eseguito con detersivi alcalini il più rapidamente possibile attenendosi scrupolosamente alle indicazioni e procedure d'utilizzo indicati in etichetta.

Procedere come segue:

- Preparare il detergente come indicato in etichetta (si consiglia di effettuare prove preliminari su piastrelle non posate per verificare l'inalterabilità della superficie della piastrella)
- Bagnare preventivamente il pavimento con acqua pulita
- Stendere la soluzione sulle piastrelle lasciando che agisca per qualche minuto

- Passare la monospazzola utilizzando dischi appropriati (verdi per le superfici strutturate e rosso per le non strutturate) o una paglietta (verde per le superfici strutturate e rossa/marrone per le non strutturate) strofinando energicamente la superficie delle piastrelle.
- Risciacquare abbondantemente con acqua pulita aspirando il liquido

PULIZIA FINE CANTIERE STUCCO EPOSSIDICO	TIPO DI DETER-GENTE	PRODOTTO	PRODUTTORE
		EPOXY REMOVER	FABER CHIMICA
	Detergente alcalino	FILA CR	10 FILA

B) PULIZIA QUOTIDIANA

La pulizia ordinaria può essere fatta con l'ausilio di normali detersivi neutri adatti alla pulizia delle superfici ceramiche, eventualmente diluendoli in acqua calda per aumentarne l'efficacia, attenendosi alle istruzioni in etichetta del produttore

recommendations for grouting and cleaning after installation

The final cleaning of any powdery layer of grout from the surface should be carried out when the grout is completely dry (at least 36-48 hours) by cleaning with acid-based detergents by hand (sponge or cloth) or by machine (single brush floor cleaning machine) paying close attention to the recommendations below.

1. Recommended products.

A buffered acid cleaner, diluted in a 1:5 ratio (1 liter in 5 liters of hot water) in hot water if possible is recommended.

Quantity: 6 liters of acid cleaner per 100m2.

Avoid using diluted muriatic acid (due to the release of harmful fumes and the way it "burns" the joints).

2. Procedure

a - Wet the grout with water only in order to protect it from any corrosion from the diluted acid solution;
b - Distribute the diluted acid solution using a normal mop/floor-washer or a coarse rag for residential spaces, or with a single-brush floor washing machine for large surfaces;
c - Allow to act for several minutes depending on how dirty the surface is;
d - Clean vigorously with a commercial scotch-brite sponge or with a scrubber;
e - Wipe up any residue using cloths or with a wet/dry vacuum;
f - Rinse abundantly with clean warm water, repeating the operation several times until any marks or residue in the cracks is eliminated.

To maintain the original shine and beauty of your tiles after fixing, the correct cleaning procedures must be followed.

A) IMMEDIATE ACTION AFTER LAYING AND GROUTING:

Cleaning the tiles immediately after the initial fixing and, again after the grouting, is very important.

At this point thoroughly wash the surface and joints of the tile with clean water several times. This will ensure any residual adhesive or grout will not set on the surface of the tile causing cleaning difficulties later. This is particularly important when fixing tiles with a structured or non slip surface. When grouting tiles with a structured surface it is advisable to ensure grout does not get spread across the whole surface of the tile.

Secondary Cleaning:

Whilst thorough washing with clean water will remove residual adhesive and grout from the surface of the tile a proprietary acid based cleaning agent should be applied within 2-3 days of laying to completely clean the surface of the tile. When using secondary cleaning agents it is advisable to "test" the product on a loose tile first to ensure the surface shine and brilliance of the tile is not affected.Recommended Secondary Cleaning Detergents For Water Based Adhesive and Grout:

CLEANING CEMENT-BASED GROUT AFTER INSTALLATION	TYPE OF DETERGENT	PRODUCT	MANUFACTURER
	Acid detergent	CEMENT REMOVER	FABER CHIMICA
		KERANET	MAPEI
		DERTERDEK	FILA

Recommended secondary Cleaning for Epoxy Grouted Floors:

When using epoxy grouts it is important to remember they harden much more quickly than conventional water based cement grouts. It is therefore necessary to carry out the cleaning procedures immediately using an alkaline detergent.

CLEANING EPOXY-BASED GROUT AFTER INSTALLATION	TYPE OF DETERGENT	PRODUCT	MANUFACTURER
	Alkaline detergent	EPOXY REMOVER	FABER CHIMICA
		FILA CR	10 FILA

B) EVERYDAY CLEANING AND MAINTENANCE:

For day to day general cleaning you should use any normal neutral detergent suitable for the cleaning of ceramic or porcelain files. Dilute with warm water and always follow the instructions on the product label.

SUPERFICI LAPPATE			
PULIZIA FINE CANTIERE STUCCO CEMENTIZIO	TIPO DI DETERGENTE	PRODOTTO	PRODUTTORE
	Detergente acido	TILE CLEANER	FABER CHIMICA
		FILA CLEANER	FILA
		FLOOR CLEANER	FABER CHIMICA
PROCEDURA *	Per stucchi cementizi additivati con resine o lattici occorre effettuare la rimozione subito con spugna e abbondante acqua. Lavare con una soluzione di detergente leggermente acido o neutro, diluito in acqua secondo le modalità comunicate dal fabbricante, mediante monospazzola o spazzola in saggina, frizionare energicamente. Risciacquare abbondantemente con acqua pulita rimuovendo completamente il liquido tramite spatola gommata e stracci o aspiraliquidi. Ripetere il lavaggio e il risciacquo per due volte con acqua pulita e quindi lasciare asciugare accuratamente.		
PULIZIA FINE CANTIERE STUCCO EPOSSIDICO	TIPO DI DETERGENTE	PRODOTTO	PRODUTTORE
	Detergente alcalino	EPOXY REMOVER	FABER CHIMICA
		FILA CR 10	FILA
PROCEDURA *	Per stucchi epossidici la rimozione deve essere fatta immediatamente con spugna e abbondante acqua. Il giorno successivo alla stuccatura lavare la pavimentazione con soluzione a base di detergente alcalino, diluito in acqua secondo le indicazioni comunicate dal fabbricante, per mezzo di monospazzola o spazzola in saggina frizionando energicamente. Risciacquare abbondantemente con acqua pulita asportando completamente il liquido tramite spatola gommata e stracci o aspiraliquidi. Ripetere il lavaggio e il risciacquo con acqua pulita per due volte e quindi lasciare asciugare accuratamente. Se dovessero rimanere residui traslucidi di stucco utilizzare un solvente idoneo come può essere un diluente al nitro.		
PULIZIA CONSIGLIATA PRIMA DI ARREDARE I LOCALI	TIPO DI DETERGENTE	PRODOTTO	PRODUTTORE
	Detergente leggermente acido o neutro	TILE CLEANER	FABER CHIMICA
		FILA CLEANER	FILA
		FLOOR CLEANER	FABER CHIMICA
PROCEDURA *	Lavare la pavimentazione con soluzione di detergente leggermente acido o detergente neutro, diluito in acqua secondo le indicazioni comunicate dal fabbricante, mediante monospazzola o spazzola in saggina frizionando energicamente. Risciacquare abbondantemente con acqua pulita rimuovendo completamente il liquido tramite spatola gommata e stracci o aspiraliquidi. Ripetere il lavaggio e il risciacquo con acqua pulita per due volte e quindi lasciare asciugare accuratamente.		
MANUTENZIONE ORDINARIA	TIPO DI DETERGENTE	PRODOTTO	PRODUTTORE
	Detergente neutro	FILA CLEANER	FILA
		FLOOR CLEANER	FABER CHIMICA
PROCEDURA *	Lavare il pavimento con detergenti neutri diluiti in acqua seguendo le istruzioni comunicate dal fabbricante. Non utilizzare prodotti con cere o additivi lucidanti. Sciacquare abbondantemente con acqua pulita e quindi lasciare asciugare accuratamente.		
MANUTENZIONE DOPO 4 ANNI	TIPO DI DETERGENTE	PRODOTTO	PRODUTTORE
	Protettivo antimacchia per superfici lucide base solvente	FILA MP90	FILA
PROCEDURA *	No diluizione: pronto all'uso. Applicazione: 1. Su superficie asciutta e pulita applicare il prodotto con pennello in modo uniforme e continuo. 2. Dopo 24 ore, a pavimento asciutto, rimuovere i residui con un panno imbevuto del prodotto stesso, di seguito asciugare con panno asciutto o carta assorbente. Manutenzione: soluzione diluita di FILA CLEANER.		
RIMOZIONE MACCHIE COLORATE (vino, frutta, caffè, nicotina)	TIPO DI DETERGENTE	PRODOTTO	PRODUTTORE
	Detergente polifunzionale	COLORED STAIN REMOVER	FABER CHIMICA
		PS 87	FILA
PROCEDURA *	Utilizzare secondo le concentrazioni indicate dal fabbricante, direttamente sulla macchia, lasciare agire secondo i tempi indicati dal fabbricante, e risciacquare la superficie. Se la macchia dovesse persistere ripetere l'operazione.		
RIMOZIONE DI SOSTANZE GRASSE	TIPO DI DETERGENTE	PRODOTTO	PRODUTTORE
	Detergente polifunzionale	OIL & GREASE REMOVER	FABER CHIMICA
		PS 87	FILA
PROCEDURA *	Utilizzare secondo le concentrazioni indicate dal fabbricante direttamente sulla macchia, lasciare agire secondo i tempi suggeriti e asportare il residuo con spugna umida. Se la macchia dovesse persistere ripetere l'operazione.		

SUPERFICI NATURALI E STRUTTURATE			
PULIZIA FINE CANTIERE STUCCO CEMENTIZIO	TIPO DI DETERGENTE	PRODOTTO	PRODUTTORE
	Detergente acido	CEMENT REMOVER	FABER CHIMICA
		KERANET	MAPEI
		DETERDEK	FILA
PROCEDURA *	Per stucchi cementizi additivati con resine o lattici occorre effettuare la rimozione subito con spugna e risciacquare abbondantemente. Utilizzare a stucco indurito, mai oltre 7 giorni, un detergente acido post posa diluito in acqua seguendo le modalità comunicate dal fabbricante mediante monospazzola o spazzola in saggina e frizionare. Sciacquare abbondantemente con acqua pulita, rimuovendo completamente il liquido tramite spatola gommata e stracci puliti o aspiraliquidi. Ripetere il lavaggio e il risciacquo con acqua pulita per due volte e quindi lasciare asciugare accuratamente.		
PULIZIA FINE CANTIERE STUCCO EPOSSIDICO	TIPO DI DETERGENTE	PRODOTTO	PRODUTTORE
	Detergente alcalino	EPOXY REMOVER	FABER CHIMICA
		FILA CR 10	FILA
PROCEDURA *	Lavare il pavimento con soluzione detergente leggermente acida o neutra, diluita in acqua secondo le indicazioni comunicate dal fabbricante, mediante monospazzola o spazzola in saggina frizionando energicamente. Sciacquare abbondantemente con acqua pulita, rimuovendo completamente il liquido tramite spatola gommata e stracci puliti o aspiraliquidi. Ripetere il lavaggio e il risciacquo con acqua pulita per due volte e quindi lasciare asciugare accuratamente.		

MANUTENZIONE ORDINARIA	TIPO DI DETERGENTE	PRODOTTO	PRODUTTORE
	Detergente neutro	FILA CLEANER	FILA
		FLOOR CLEANER	FABER CHIMICA
PROCEDURA *	Utilizzare secondo le concentrazioni comunicate dal fabbricante, direttamente sulla macchia, lasciare agire secondo i tempi indicati dal fabbricante, e risciacquare la superficie con acqua pulita. Se la macchia dovesse persistere ripetere l'operazione.		
RIMOZIONE MACCHIE COLORATE (vino, frutta, caffè, nicotina)	TIPO DI DETERGENTE	PRODOTTO	PRODUTTORE
	Detergente polifunzionale	COLORED STAIN REMOVER	FABER CHIMICA
		PS 87	FILA
PROCEDURA *	Utilizzare secondo le concentrazioni indicate dal fabbricante, direttamente sulla macchia, lasciare agire secondo i tempi indicati dal fabbricante, e risciacquare la superficie. Se la macchia dovesse persistere ripetere l'operazione.		
RIMOZIONE DI ALONATURE LUCIDE /OPACHE	TIPO DI DETERGENTE	PRODOTTO	PRODUTTORE
	Detergente polifunzionale	TILE CLEANER	FABER CHIMICA
		PS 87	FILA
PROCEDURA *	Utilizzare secondo le concentrazioni comunicate dal fabbricante direttamente sulla macchia, lasciare agire secondo i tempi suggeriti e rimuovere il residuo con spugna umida. Se la macchia dovesse persistere ripetere l'operazione.		

Nel caso di residui di sporco non rimovibili con detergenti di uso comune si consiglia di consultare la tabella sottostante:

TIPO DI SPORCO	SOLUZIONE	DETERGENTI	PRODUTTORE
MACCHIE INORGANICHE			
carbone - efflorescenze calcaree - gesso - segni metallici - ruggine - matita (grafite) - tempere naturali	ACIDA	DETERDEK TILE CLEANER	Fila Industria Chimica S.p.A. Faber Chimica
MACCHIE ORGANICHE			
Tracce di gomma (suole,pneumatici)	ALCALINA	FILA PS/87 TILE CLEANER	Fila Industria Chimica S.p.A. Faber Chimica
coca cola - caffè - vino - birra - gelato - oli e grassi animali e vegetali - mostarda - ketchup - maionese - marmellata - tintura per capelli - shampoo - rossetto - chewing-gum - inchiostri lampostil	ALCALINA	FILA PS/87 TILE CLEANER	Fila Industria Chimica S.p.A. Faber Chimica
MACCHIE SINTETICHE			
oli silconici e meccanici - silicone - resine - smalti - lacche - bitume - cera di candele - vernice - catrame - caucciù - residui di scotch	SOLVENTE	FILASOLV ACETONE DILUENTE NITRO	Fila Industria Chimica S.p.A. In Commercio In Commercio
CASI PARTICOLARI			
TIPO DI SPORCO	DETERGENTI	MODO OPERATIVO	
MACCHIE PARTICOLARI			
rimozione di cere protettive	DETERDEK (Fila) TILE CLEANER (Faber)	Per l'eliminazione dei residui di cera, compiere il lavaggio acido strofinando energeticamente con tampone scotch-brite fino a completa eliminazione del materiale solido. Nel caso in cui dovessero rimanere alonature silconiche, distribuire FILASOLV lasciando agire fino a completa evaporazione. Risciacquare abbondantemente con acqua calda pulita.	
alonature rotonde delle ventose	FILA HOBBY (Fila) PS/87 (Fila)	Spruzzare con l'apposito spruzzo (per FILA HOBBY) il detergente sulla piastrina che presenta l'alone. Lasciare agire per qualche secondo (mai fino ad asciugamento completo), strofinare energicamente con tampone scotch-brite inumidito e risciacquare abbondantemente con acqua calda pulita.	
MACCHIE RESISTENTI			
tutte le macchie inorganiche (vedi sopra) che non vengono rimosse con DETERDEK	PH ZERO (Fila Industria Chimica)	PH ZERO è un acido piu' forte del DETERDEK e pertanto la sua azione è piu' aggressiva verso le macchie di natura inorganica. Da usare solo in casi giudicati estremi e dopo aver provato, anche piu' volte, con DETERDEK.	
tutte le macchie organiche (vedi sopra) che non vengono rimosse con PS/87	DRASTIC (Fila Industria Chimica)	DRASTIC è un prodotto alcalino piu' forte del PS/87 e pertanto la sua azione è piu' aggressiva verso le macchie di natura organica. Da usare solo in casi giudicati estremi e dopo aver provato, anche piu' volte, con PS/87.	

LAPPED SURFACES			
CLEANING CEMENT-BASED GROUT AFTER INSTALLATION	TYPE OF DETERGENT	PRODUCT	MANUFACTURER
	Acid detergent	TILE CLEANER	FABER CHIMICA
		FILA CLEANER	FILA
		FLOOR CLEANER	FABER CHIMICA
PROCEDURE *	Residues of cement-based grouts containing resin or latex must be removed immediately with a sponge. Rinse with plenty of water. Wash with a mildly acid or neutral cleaning solution, diluted in water as indicated by the manufacturer. Rub vigorously with a motorised brush or broom. Rinse thoroughly with clean water. Soak up liquid with a rubber-coated squeegee, clean cloths or liquid remover. Repeat cleaning and rinse twice with clean water. Allow to dry.		
CLEANING EPOXY-BASED GROUT AFTER INSTALLATION	TYPE OF DETERGENT	PRODUCT	MANUFACTURER
	Alkaline detergent	EPOXY REMOVER	FABER CHIMICA
		FILA CR 10	FILA
PROCEDURE *	Epoxy-based grout must be removed immediately with a sponge. Rinse with plenty of water. The day of grouting, wash the floor with an alkaline detergent, diluted as indicated by the manufacturer. Rub vigorously with a motorised brush or broom. Rinse thoroughly with clean water. Soak up liquid with a rubber-coated squeegee, clean cloths or liquid remover. Repeat cleaning and rinse twice with clean water. Allow to dry. If grout stains remain, use a suitable solvent, such as a nitro thinner.		
RECOMMENDED CLEANING BEFORE FURNISHING ROOMS	TYPE OF DETERGENT	PRODUCT	MANUFACTURER
	Mildly acid or neutral detergent	TILE CLEANER	FABER CHIMICA
		FILA CLEANER	FILA
		FLOOR CLEANER	FABER CHIMICA
PROCEDURE *	Wash the floor with a mildly acid or neutral cleaning solution, diluted in water as indicated by the manufacturer. Rub vigorously with a motorised brush or broom. Rinse thoroughly with clean water. Soak up liquid with a rubber-coated squeegee, clean cloths or liquid remover. Repeat cleaning and rinse twice with clean water. Allow to dry.		
ROUTINE CARE	TYPE OF DETERGENT	PRODUCT	MANUFACTURER
	Neutral detergent	FILA CLEANER	FILA
		FLOOR CLEANER	FABER CHIMICA
PROCEDURE *	Wash the floor with a neutral detergent, diluted in water as indicated by the manufacturer. Never use wax-based products or glossenhancers. Rinse thoroughly with clean water and allow to dry.		
CARE AFTER 4 YEARS	TYPE OF DETERGENT	PRODUCT	MANUFACTURER
	Natural look penetrating sealer - solvent technology	FILA MP90	FILA
PROCEDURE *	No dilution required: ready to use. Application: 1. Using a paintbrush, apply the product evenly and continually to a clean dry surface. 2. After 24 hours, when the floor is dry, remove any residues with a cloth dampened with the same product. Dry with a dry cloth or kitchen towel. Maintenance: diluted solution of FILA CLEANER.		
REMOVAL OF COLOURED STAINS (wine, fruit, coffee, nicotine)	TYPE OF DETERGENT	PRODUCT	MANUFACTURER
	Multipurpose detergent	COLORED STAIN REMOVER	FABER CHIMICA
		PS 87	FILA
PROCEDURE *	Apply directly to the stain and allow to soak, for the time and in the concentration indicated by the manufacturer. Then rinse the surface. If the stain remains, repeat.		
REMOVAL OF GREASY SUBSTANCES	TYPE OF DETERGENT	PRODUCT	MANUFACTURER
	Multipurpose detergent	OIL & GREASE REMOVER	FABER CHIMICA
		PS 87	FILA
PROCEDURE *	Apply directly to the stain and allow to soak, for the time and in the concentration indicated by the manufacturer. Remove residue with a moist sponge. If the stain remains, repeat.		

NATURAL AND TEXTURED SURFACES			
CLEANING CEMENT-BASED GROUT AFTER INSTALLATION	TYPE OF DETERGENT	PRODUCT	MANUFACTURER
	Acid detergent	CEMENT REMOVER	FABER CHIMICA
		KERANET	MAPEI
		DETERDEK	FILA
PROCEDURE *	Residues of cement-based grouts containing resin or latex must be removed immediately with a sponge. Rinse with plenty of water. To remove hardened grout (within 7 days from installation), use an acid detergent for after-installation cleaning, diluted in water in accordance to the manufacturer's instructions. Apply and rub with a motorised brush or broom. Rinse thoroughly with clean water. Soak up liquid with a rubber-coated squeegee, clean cloths or liquid remover. Repeat cleaning and rinse twice with clean water. Allow to dry.		
CLEANING EPOXY-BASED GROUT AFTER INSTALLATION	TYPE OF DETERGENT	PRODUCT	MANUFACTURER
	Alkaline detergent	EPOXY REMOVER	FABER CHIMICA
		FILA CR 10	FILA
PROCEDURE *	Wash the floor with a mildly acid or neutral cleaning solution, diluted in water as indicated by the manufacturer. Rub vigorously with a motorised brush or broom. Rinse thoroughly with clean water. Soak up liquid with a rubber-coated squeegee, clean cloths or liquid remover. Repeat cleaning and rinse twice with clean water. Allow to dry.		
ROUTINE CARE	TYPE OF DETERGENT	PRODUCT	MANUFACTURER
	Neutral detergent	FILA CLEANER	FILA
		FLOOR CLEANER	FABER CHIMICA
PROCEDURE *	Wash the floor with a neutral detergent, diluted in water as indicated by the manufacturer. Never use wax-based products or gloss-enhancers. Rinse thoroughly with clean water and allow to dry.		
REMOVAL OF COLOURED STAINS (wine, fruit, coffee, nicotine)	TYPE OF DETERGENT	PRODUCT	MANUFACTURER
	Multipurpose detergent	COLORED STAIN REMOVER	FABER CHIMICA
		PS 87	FILA
PROCEDURE *	Apply directly to the stain and allow to soak, for the time and in the concentration indicated by the manufacturer. Rinse thoroughly with clean water. If the stain remains, repeat.		
REMOVING GLOSSY / MATT MARK	TYPE OF DETERGENT	PRODUCT	MANUFACTURER
	Multipurpose detergent	TILE CLEANER	FABER CHIMICA
		PS 87	FILA
PROCEDURE *	Apply directly to the stain and allow to soak, for the time and in the concentration indicated by the manufacturer. Remove residue with a moist sponge. If the stain remains, repeat.		

If dirt residue cannot be removed using standard detergents, refer to the following table:

TYPE OF DIRT	SOLUTION	DETERGENTS	MANUFACTURER
INORGANIC STAINS			
coal, lime efflorescence, plaster, metallic marks, rust, pencil (graphite), natural paints.	ACID	DETERDEK TILE CLEANER	Fila Industria Chimica S.p.A. Faber Chimica
ORGANIC STAINS			
traces of rubber (soles of shoes, tyres)	ALKALINE	FILA PS/87 TILE CLEANER	Fila Industria Chimica S.p.A. Faber Chimica
coca cola, coffee, wine, beer, ice-cream, animal and vegetable oils and fats, mustard, ketchup, mayonnaise, jam, hair dye, shampoo, lipstick, chewing-gum, marker pen ink	ALKALINE	FILA PS/87 TILE CLEANER	Fila Industria Chimica S.p.A. Faber Chimica
SYNTHETIC STAINS			
silicone and machine oils, silicone, resins, varnish, lacquer, bitumen, candle wax, paint, tar, india rubber, adhesive tape residues	SOLVENT	FILASOLV ACETONE DILUENTE NITRO	Fila Industria Chimica S.p.A. In Commercio In Commercio
SPECIFIC CASES			
TYPE OF DIRT	DETERGENTS	CLEANING METHOD	
SPECIFIC STAINS			
remove of protective waxes	DETERDEK (Fila) TILE CLEANER (Faber)	For the elimination of wax residues use acid cleaning, scrubbing vigorously with a scotch-brite buffer until complete removal of the solid material. If silicone haloes remain, apply FILASOLV, leaving it to act until it has completely evaporated. Rinse thoroughly with hot, clean water.	
round suction cap marks	FILA HOBBY (Fila) PS/87 (Fila)	Use the specific nozzle (for FILA HOBBY) to spray the detergent onto the marked tile and leave to act for a few seconds (never until completely dry). Scrub vigorously with a damp scotch-brite buffer and rinse thoroughly with hot, clean water.	
RESISTANT STAINS			
all inorganic stains (see above) not removed with DETERDEK	PH ZERO (Fila Industria Chimica)	PH ZERO is a stronger acid than DETERDEK and therefore has a more aggressive action against inorganic stains. Only for use in cases which are deemed to be extreme, after trying repeatedly with DETERDEK.	
all organic stains (see above) not removed with PS/87	DRASTIC (Fila Industria Chimica)	DRASTIC is a stronger alkaline product than PS/87 and so has a more aggressive action against organic stains. Only for use in cases which are deemed to be extreme, after trying repeatedly with PS/87.	

LAPPATURA

- A) La lappatura consiste nell'asportare la parte più vetrificata e resistente della piastrella, sia superficiale che laterale (seguito rettifica dei bordi). In tal modo si determina un aumento della “porosità” della superficie ed una riduzione della sua capacità di protezione dalle macchie.
- B) Non esiste in commercio un trattamento protettivo duraturo nel tempo. Eventualmente è possibile fornire su richiesta uno speciale trattamento impermeabilizzante che deve essere ripetuto periodicamente.
- C) Si raccomanda la posa di materiale lappato solo in ambienti residenziali (privati) e comunque poco trafficati.
- D) Si raccomanda, per la posa, l'utilizzo di materie prime (colla e stucchi) di prima qualità e soprattutto di acqua pulita in modo da evitare il sorgere di aloni. Si consiglia inoltre, prima della stuccatura, l'utilizzo di un prodotto idrorepellente allo scopo di agevolare la pulizia.
- E) Dopo la posa si deve coprire il pavimento con segatura e/o altro, in modo da evitare lo sfregamento causato da scarpe non pulite e dalla movimentazione del mobilio in fase di arredamento.
- F) Il procedimento della lappatura stonalizza il materiale. Pertanto una miscelazione dei toni, tipica delle pietre naturali, è sempre presente.

SEMI-POLISHING (LAPPATURA)

- A) By the process of semi-polishing the more vetrified and resistant part of the tile (top layer but also on the edges) is partially removed. In this way the porosity of the tile increases reducing the stain resistance of the tile surface.
- B) There is no long lasting protective treatment or chemical coverage. but it is possible to demand for a special waterproof treatment which must be periodically repeated.
- C) We do recommend to lay down semi-polished tiles only in private housing places.
- D) We do recommend to use quality raw material (glues, adhesives and grouts) and, in particular, clean water to avoid the formation of stains or marks.
- E) Immediately after the laydown it is recommended to cover the entire floor with sawdust and/or something else to avoid the rubbing/crackling caused by dirty shoes or furniture moving.
- F) This process (LAPPATURA) might change the tonality of the material and/or make it vary. Therefore the shading effect is quite common.

LAPPATO

- A) Le traitement de surface “Lappato” (aspect pierre polie), consiste à retirer la part la plus vitrifiée et résistante du carreau - tant au niveau de sa surface qu’au niveau latéral (du fait notamment de la rectification des bords). A ce niveau, on doit constater une augmentation du taux de porosité de la surface du carreau ainsi qu’une réduction de ses facultés de protection aux taches de toutes origines.
- B) Aucun traitement de protection durable dans le temp n’existe aujourd’hui sur le marché. Il peut toutefois, être possible du fournir, sur demande spécifique, un traitement spécial imperméabilisant qui doit être régulièrement réalisé.
- C) Nous recommandons la pose de ces carrelages “finition Lappato”, uniquement dans les seuls environnements d’habitations (appartements et maisons) résidentiels, et de faibles trafics.
- D) Au niveau de leur pose, nous recommandons, l'utilisation de matières premières (colles et joints) de toute première qualité, et surtout d’eau très claire et propre, sans impuretés, de façon à éviter toute apparition de résidus à la surface qui altèreraient le contact avec celle-ci.
- E) Une fois le carrelage posé, il est nécessaire de le recouvrir avec de la sciure de bois ou tout autre protection, afin d’éviter tout endommagement de la surface par des chaussures avec des semelles salies de terre et autres pierres, ou par le déplacement de meubles lors d’emménagements dans le s pièces concernées.
- F) Enfin, nous vous rappelons que le procédé de la “Finition Lappato” entraîne automatiquement une “détonalisation” de l’ensemble de la surface, avec par conséquent, un mélange de différentes tonalités, typique des pierres vieillies naturelles; cet aspect de tonalités mélangées doit être accepté à l’avance par le client et surtout, doit faire l’objet d'une information préalable très claire de la part du vendeur.

TEILPOLITUR

- A) Die Teilpolitur besteht in der Abführung des gläsigsten und widestandfähigsten Teils der Fliese, oberflächlich und seitlich (durch Rektifizierung der Kanten). Dadurch entsteht eine Steigerung der “Porosität” der Oberfläche und somit eine Schutzminderung bezüglich der Flecke.
- B) Im Handel leider existiert keine dauerhafte Behandlung für den Schutz ev. ist es möglich, auf Anfrage eine Wasserdicht machende Behandlung zu liefern, die aber periodisch wiederholt werden muss.
- C) Die Verlegung teilpolierten Materials ist nur in Wohnbereich zu empfehlen allerdings im wenig benutzten Räumen.
- D) Für die Verlegung ist die Verwendung von Stoffen (Kleber u. Fugenmaterial) erster Klasse und vor allem von Reinemwasser zu empfehlen, um die Entstehung von Fleckekreisen zu vermeiden.
- E) Nach der Verlegung soll der Boden mit Sägemehl oder ähnlichem gedeckt werden, um vor der Trockung die Verkratzung durch unsaubere Schün oder durch Versetzung der Möbel zu vermeiden.
- F) Das Teilpolierungsverfahren nuanciert die Fliese, daher ist eine Mischung der Töne, tipisch für Natursteine, imer gegeben.

AVVERTENZA PER I SIGNORI POSATORI

Controllare attentamente il materiale prima della posa, particolarmente tono, calibro e scelta. Non si accettano reclami sul materiale posato.

NOTICE TO TILE FIXERS

Goods should be carefully checked before fixing, especially tonality, caliber and choice. Claims cannot be accepted once the goods are laid.

AVIS AUX CARRELEURS

Contrôler attentivement les carreaux avant la pose particulièrement tonalité, calibre choix. Aucune réclamation ne sera acceptée une foi que le matériel est posé.

HINWEIS FUER DIE VERLEGUNG

Das material ist vor de Verlegung genau zu ueberpruefen besonders Tonalität, Kaliber und Sorte. Reklamationen nach der Verlegung werden nichth akzeptiert

Si consiglia la posa a colla – The use of tile adhesive is recommended - Pose a la colle conseillée - Es wird die verlegung im klebebett empfohlen Doradza sie montaz na klej.

RACCOMANDAZIONI SULLA POSA, PULIZIA E MANUTENZIONE FP2

Il Cavallino consiglia di effettuare le operazioni di pulizia ordinaria delle superfici pavimentate con FP2 ricorrendo a acqua e normali detergenti neutri: la pendenza della superficie e gli spazi tra le lastre nelle pose a secco facilitano il naturale deflusso delle acque.

Si consideri tuttavia che qualunque tipo di pavimentazione è soggetta al fenomeno della tensione superficiale dei liquidi: si tratta della stessa proprietà dell’acqua che le conferisce la tendenza a distribuirsi in gocce sferiche, o che causa la formazione della classica bombatura in un bicchiere pieno di acqua oltre il colmo.

La tensione superficiale può impedire un completo scolo dell’acqua,

e causare lo stazionamento temporaneo di una patina di liquido in corrispondenza dei bordi delle lastre. Per ovviare a questo problema, Il Cavallino raccomanda di prevedere le opportune pendenze della superficie in fase di installazione, per facilitare il deflusso delle acque negli spazi tra le lastre. Se dovesse persistere una patina di acqua, si consiglia di spingerla verso le fughe con uno spazzolone, oppure di rimuoverla con un aspira liquidi.

PORCELAIN TILES IN 20MM THICKNESS (FP2) FOR OUTDOOR FLOORS RECOMMENDATIONS FOR THE INSTALLATION, CLEANING AND MAINTENANCE

Il Cavallino recommends carrying out the procedures for the ordinary cleaning of FP2 floor surfaces using water and commercially available neutral detergents: the inclination of the surface and the space between adjacent slabs for dry-system installation favour the natural flow of water.

However, it is important to take into consideration that any type of floor surface is subject to the surface tension effect of liquids: it is the same property of water that gives the tendency to transform into spherical droplets and which cause the curved top surface of a glass full of water.

The surface tension can obstacle the complete drainage of water and cause a temporary stagnation of liquid on the slab edges. In order to avoid this problem,

Il Cavallino recommends ensuring adequate inclination of the surface during installation so as to encourage the flow of water between adjacent slabs. Should liquid deposit on the surface, it is recommended to push it towards grout lines using a brush or remove it with a wet and dry vacuum cleaner.

GRÈS CÉRAME EN 20 MM (FP2) D’ÉPAISSEUR POUR DES SOLS EXTÉRIEURS CONSEILS SUR LA POSE, NETTOYAGE ET ENTRETIEN

Il Cavallino conseille d’effectuer les opérations de nettoyage ordinaire

des surfaces carrelées avec FP2 en utilisant de l’eau et des détergents neutres communs: l’inclinaison de la surface et les espaces entre les dalles dans les poses à sec facilitent l’écoulement naturel de l’eau.

Considérez cependant que tout type de sol est soumis au phénomène de la tension superficielle des liquides: il s’agit de la même propriété de l’eau qui lui donne la tendance à se répandre en gouttes sphériques, ou qui entraîne la formation classique de la surface bombée d’un verre d’eau rempli à ras bord.

La tension superficielle peut empêcher l’écoulement de l’eau, et causer la stagnation temporaire d’une légère patine d’eau au niveau des bords des dalles. Pour résoudre ce problème, Il Cavallino conseille de prévoir les pentes opportunes de la surface en phase d’installation, pour faciliter l’écoulement des eaux dans les espaces entre les dalles. Si la patine d’eau persiste, il est conseillé de la pousser vers les joints à l’aide d’une brosse à carrelage ou bien de l’éliminer avec un aspirateur à liquide

20 MM (FP2) STARKES FEINSTEINZEUG FÜR AUSSENBODENBELÄG EMPFEHLUNGEN FÜR DIE VERLEGUNG, REINIGUNG UND PFLEGE

Il Cavallino empfiehlt, zur normalen Reinigung der mit FP2 verlegten Flächen Wasser und normale, neutrale Reinigungsmittel zu verwenden; das Gefälle der Flächen und die im Trockenbau entstehenden Zwischenräume zwischen den Platten erleichtern das natürliche Abfließen des Wassers.

Auf jeder Art von Bodenbelag kommt es jedoch zur Oberflächenspannung der Flüssigkeiten: es handelt sich um ein Merkmal des Wassers selbst, das sich in runden Tropfen verteilt bzw. die klassische Wölbung in einem randvoll gefüllten Glas aufweist. Die Oberflächenspannung kann das vollständige Ablaufen des Wassers behindern und dazu führen, dass sich vorübergehend Flüssigkeit an den Plattenrändern ansammelt.

Um dieses Problem zu vermeiden, empfiehlt Il Cavallino, bei der Installation für eine angemessene Neigung der Fläche zu sorgen, damit das Wasser über die Zwischenräume ablaufen kann. Auf der Oberfläche stagnierendes Wasser sollte mit einer Bürste in die Zwischenräume gedrückt oder mit einem Allsauger abgesaugt werden.

AVVERTENZA PER I SIGNORI POSATORI

Controllare attentamente il materiale prima della posa, particolarmente tono, calibro e scelta. Non si accettano reclami sul materiale posato.

NOTICE TO TILE FIXERS

Goods should be carefully checked before fixing, especially tonality, caliber and choice. Claims cannot be accepted once the goods are laid.

AVIS AUX CARRELEURS

Contrôler attentivement les carreaux avant la pose particulièrement tonalité, calibre choix. Aucune réclamation ne sera acceptée une foi que le matériel est posé.

HINWEIS FUER DIE VERLEGUNG

Das material ist vor de Verlegung genau zu ueberpruefen besonders Tonalität, Kaliber und Sorte. Reklamationen nach der Verlegung werden nichth akzeptiert

Si consiglia la posa a colla – The use of tile adhesive is recommended - Pose a la colle conseillée - Es wird die verlegung im klebebett empfohlen Doradza sie montaz na klej.

spessore - tickness - epaisseur - stärke



resistenza allo scivolamento DIN 51130 - sliding resistance DIN 51130 -
résistance au glissement DIN 51130 - gleitwiderstands DIN 51130



stampa digitale
digital print - haute definition - Digitaltechnik



glossy matt semi-glossy



rivestimenti
wall tiles - faiences - Wandfliesen



pavimenti
floor tiles - carrelage sol - Bodenfliesen



resistenza allo scivolamento DIN 51130 - sliding resistance DIN 51130 -
résistance au glissement DIN 51130 - gleitwiderstands DIN 51130

V1 **V1/LOW**

 Aspetto uniforme
 Uniform appearance
 Aspect uniforme
 Einheitliches Aussehen
LOW

V2 **V2/MODERATE**

 Lieve variazione
 Slight variations
 Légère variation
 Leichte Abweichung
MODERATE

V3 **V3/HIGH**

 Moderata variazione
 Moderate variations
 Variation modérée
 Mäßige Abweichung
HIGH

V4 **V4/RANDOM**

 Forte stonizzazione
 Substantial variations
 Effet dénuancé très accentué
 Starkes Farbspiel
RANDOM

- La diversità di grafica e la naturale stonizzazione delle piastrelle costituiscono la caratteristica propria di questa serie. Si consiglia di miscelare le varie scatole durante la posa e di scegliere le piastrelle da diversi colli per evitare il ripetersi della stessa grafica accostata.
- The different graphics and the natural shading of each tile are intentional characteristics of this range. When laying tiles, we recommend mixing the various boxes and choosing tiles from different boxes, in order to avoid placing tiles with identical graphics adjacent to each other.
- La diversité graphique et la variété de tonalités naturelle des carreaux caractérisent cette série. Il est recommandé de mélanger les carreaux de différentes boîtes au cours de la pose et de les choisir dans différents colis pour éviter que les mêmes dessins ne se trouvent côte à côte.
- Die unterschiedlichen Maserungen und der natürlichen Farbspiel sind gewollten Eigenschaften dieser Serie. Bei der Verlegung es wird empfohlen Fliesen aus verschiedenen Kartons zu mischen.

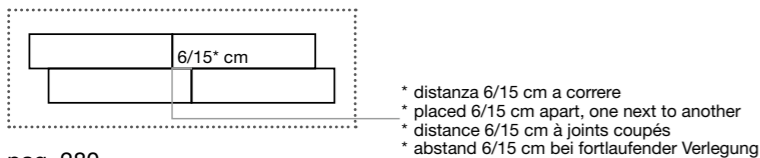

pag. 280

- Onde evitare problemi di planarità, per tutti i formati rettangolari si consiglia la posa sfalsata irregolare del prodotto come da schema. A pag. 280 sarà inoltre possibile trovare precise indicazioni utili per ottenere una posa corretta dei grandi formati con l'utilizzo del sistema R.L.S.
- Irregular offset installation is advisable in the case of rectangular shaped products, to avoid problems associated with planarity. (See drawing). Please find at page 280 precise recommendation useful to achieve a correct laying of out material and especially of big sizes.
- Pour tous les formats rectangulaires on conseille une pose décalée irrégulière afin d'éviter problèmes de planéité. (Observer le dessin). Merci de trouver à la page 280 toutes indications utiles pour une meilleure pose de nos produits et en particulier de grands formats.
- Um Planaritätsprobleme zu vermeiden, wird für die Rechteckischen Formate eine Eindrittelverlegung empfohlen, laut Skizze. Auf Seite 280 findet man sämtliche nutzbaren Informationen für eine korrekte Verlegung von großen Formaten mit System R.L.S.

condizioni generali di vendita

- La firma della conferma d'ordine, l'accettazione di una fattura o di una fornitura equivalgono all'approvazione delle presenti condizioni, le quali - in caso di rapporti commerciali correnti - sono valide anche per i singoli contratti senza indicazione particolare. La variazione o la nullità di singole condizioni non compromette la validità delle altre condizioni.
- Le dichiarazioni fatte da rappresentanti o da altri che divergessero dalle presenti condizioni, che riconoscessero difetti o che contenessero determinate garanzie, sono comunque vincolate alla nostra conferma scritta.
- Le nostre offerte sono senza impegno e si intendono con partenza dal luogo di fornitura o dal nostro deposito. Siamo autorizzati ad affidare a terzi l'esecuzione di contratti e la fatturazione; in tal caso l'acquirente accetta la validità delle nostre condizioni generali di vendita che si instaurano fra lui stesso e il nostro intermediario. Le forniture si effettuano in base alla disponibilità. Ci facciamo comunque premura di rispettare i termini di consegna ma senza garanzia alcuna.
- Ogni fornitura - parziale, successiva o allegata - costituisce un atto commerciale giuridicamente autonomo e non coinvolge le restanti consegne. Una fornitura ritardata non giustifica alcun risarcimento dei danni o annullamento del contratto.
- Difficoltà di produzione, conflitti di lavoro, catastrofi, impedimenti di trasporto, agitazioni sociali, difficoltà di reperimento di materiale grezzo, accentuato incremento dei prezzi e casi di forza maggiore ci esonerano nel contempo dall'obbligo della fornitura.
- Per ordini di materiale rettificato con posa mista e/o modulare è necessario comunicarlo al momento dell'ordine; così come per ordini di completamento. Il Cavallino S.p.A. non risponde di contestazioni di calibro se non espressamente comunicato.
- La merce ordinata - soprattutto in caso di forniture parziali dilazionate - va ritirata dall'acquirente al massimo entro un mese. La merce non prelevata - decorso il termine di presa di consegna - da parte nostra può essere utilizzata in altro modo o messa in conto senza variazioni nella scadenza di pagamento. Gli sconti a saldo verranno conteggiati o dedotti ad accettazione o pagamento avvenuti.
- La spedizione avviene per conto ed a rischio e pericolo dell'acquirente. I rischi e pericoli passano a carico dell'acquirente dal momento in cui viene segnalata la disponibilità della merce pronta per la spedizione o per il prelievo, altrimenti dal momento del prelievo stesso. In caso di merce difettosa si suppone che il difetto sia sorto dopo il passaggio della merce all'acquirente, questi semmai deve dimostrare il contrario. Danni all'imballaggio o difetti alle palette vanno denunciati al più tardi durante il carico della merce. Per quanto concerne l'utilizzo dei nostri prodotti garantiamo soltanto in conformità alle indicazioni scritte.
- La garanzia viene meno per merci di seconda o terza scelta, assortimenti minori o partite speciali, soprattutto in riferimento alla protezione dal gelo. La denuncia di eventuali difetti va effettuata al momento della presa in consegna della merce o comunque prima della sua ulteriore consegna o lavorazione, e al più tardi entro 8 giorni dalla presa in consegna va segnalata per iscritto alla nostra gestione commerciale. Siamo autorizzati ad esaminare la denuncia entro 15 giorni dalla data di arrivo. Qualora la denuncia risultasse infondata l'acquirente si assume le spese del controllo effettuato. Se invece essa risulta motivata, si procede - a nostra scelta - alla sostituzione della merce entro un adeguato lasso di tempo o ad una riduzione del prezzo d'acquisto. È esclusa ogni qualsiasi ulteriore rivendicazione. La spedizione di ritorno della merce viene accettata solo previo accordo scritto e va effettuata franco di porto, a spese e a rischio dell'acquirente, fermo restando lo stato originale della nostra merce.
- Sono esclusi i reclami per merce già posata qualora la posa non sia stata eseguita da un tecnico autorizzato dalla nostra azienda.
- I reclami per difetti nascosti vanno effettuati al più tardi entro 6 mesi dalla presa in consegna della merce.
- In caso di forniture supplementari non si garantisce per l'identità del colore rispetto alla merce già ricevuta. Non si garantisce che non vengano lesi diritti protettivi di terzi.
- Per il conteggio vale il prezzo corrente nel giorno della nostra disponibilità alla fornitura o consegna. Le consegne franco di porto e di dogana non ci obbligano alla presentazione di denaro. Le palette vengono fatturate fintanto che al momento della fornitura non riceviamo palette di ricambio. Le nostre fatture vanno saldate entro 30 giorni dalla data di emissione.
- La detrazione di sconti non è ammissibile fintanto che permangono fatture inevase. L'insolvibilità del cliente comporta un'immediata decorrenza del suo debito. La presa a riposo di cambi necessita di una convenzione particolare e funge solo da dilazione. Dalla scadenza il cliente ci offre la cessione dei suoi crediti nell'equivalente del suo debito per l'accettazione in qualsiasi momento.
- Sono validi quei pagamenti che vengono effettuati unicamente presso gli istituti bancari da noi segnalati per iscritto. I versamenti vanno conteggiati dapprima in base ai costi e agli interessi e quindi al valore fatturato.
- La vendita viene fatta con riserva di proprietà di cui agli articoli 1523 c.c. e seguenti sicché le cose vendute passeranno in proprietà all'acquirente soltanto col pagamento dell'ultima rata. L'acquirente assume tutti i rischi e pericoli anche per i casi fortuiti o di forza maggiore obbligandosi a denunciare immediatamente alla venditrice le eventuali azioni conservative o esecutive promosse da terzi nonché ogni rimozione o trasloco della merce in altre località.
- Il mancato o ritardato pagamento di una sola rata provoca la risoluzione di diritto del contratto e fa decadere il debitore dal beneficio del termine. In questo caso il committente riconosce a Il Cavallino Ceramica Artistica S.p.A. il diritto di ottenere la riconsegna della merce venduta facendo ricorso alla procedura di cui all'art. 833 c.p.c. Le rate già pagate resteranno a totale beneficio della venditrice a rifusione delle spese incontrate nella vendita e dei danni subiti salvo il diritto di ripetere i danni maggiori.
- La concordata riserva sulla proprietà comprende anche le palette e gli imballaggi. Dobbiamo essere informati sugli eventuali pignoramenti della nostra merce.
- Per qualsiasi controversia o contestazione è eletto esclusivamente competente il foro di Modena.

general conditions of sale

- Your signature on the order confirmation or the acceptance of an invoice or a supply is indicates your approval of these conditions, which - in the case of an ongoing commercial relationship - are also valid for single contracts without any particular indication. If single conditions are changed or found to be void, this will not affect the validity of the other conditions.
- In any case, statements made by representatives or others that contradict these conditions, recognise defects or that contain certain guarantees are not valid without our written confirmation.
- Our offers are not binding and are understood to be from the place of supply or our warehouse. We are authorised to entrust the execution of contracts and billing to third parties; in that case, the purchaser accepts the validity of our general conditions of sale, which are valid between the purchaser and our intermediary. Supplies are made based on availability. In any case, we undertake to respect the terms of delivery but without any guarantee.
- Each supply - partial, subsequent or annexed - is a legally-independent commercial transaction and does not involve the remaining deliveries. A late supply does not justify compensation for damages or the cancellation of the contract.
- Production difficulties, labour disputes, catastrophes, transport problems, social unrest, difficulties in obtaining raw materials, price increases and cases of force majeure will simultaneously release us from the obligation to make the supply.
- It is necessary to communicate in the time of the order if you need material rectified for modular laying or if it is a completion of an old order. Without receiving this previous communication, Il Cavallino SPA will not accept any claims for caliber problems.
- The purchaser must pick up the goods ordered within a maximum of one month - especially in the case of partially delayed supplies. After the delivery term has passed, we can use any goods that have not been picked up in another way or invoice them without any changes to payment due dates. Payment discounts will be applied or deducted upon acceptance or payment.
- Shipment is on the purchaser's behalf and its risk. Risks and dangers pass to the purchaser at the time it is notified that the goods are ready for shipment or pick-up or, otherwise, at the moment of the pick-up itself. In the case of defective goods, it is assumed that the defect arose after the transfer of the goods to the purchaser unless it can be proven otherwise. Damage to packing materials or defective pallets must be reported no later than the loading of the goods. As for the use of our products, we only guarantee conformity to their written descriptions.
- The warranty does not apply to goods of second or third quality, small assortments or special lots, especially in reference to frost protection. Any other defects must be reported at the time of the delivery of the goods or, in any case, before another delivery or work and, at the latest, within 8 days from delivery, in writing to our sales department. We are authorised to examine the claim within 15 days of its date of arrival. If the claim is determined to be unfounded, the purchaser will be responsible for the expense of the examination made. If, however, the claim is justified, we will - at our option - replace the goods within an adequate period of time or at a reduced purchase price. Any other claim is excluded. Shipments of returned goods are only accepted with our prior written agreement and must be made prepaid, at the purchaser's risk and expense, so long as our goods are in their original condition.
- No claims will be accepted for goods already laid unless performed by a technician authorised by our company.
- Claims for hidden defects must be made no later than 6 months from the delivery of the goods.
- In the case of additional supplies, we cannot guarantee that the colour will be identical to that of the goods already received. We cannot guarantee that the protective rights of third parties have not been damaged.
- Goods will be billed at their current price as of the date of our availability to make the supply or delivery. Prepaid and duty-free deliveries do not obligate us to payout cash. Pallets will be billed if, at the moment of the supply, we do not receive pallets in exchange. Our invoices are payable within 30 days from the date of issue.
- Discounts may not be taken so long as there are unpaid invoices. The customer's insolvency makes its debt immediately payable. The acceptance of bills of exchange requires a special agreement and serves only to extend the terms. Upon their expiration, the customer offers to transfer credits to us equivalent to its debt for acceptance at any time.
- The only valid payments are those made to the banking institutions specified by us in writing. Payments will be applied first to costs and interests and then to the value invoiced.
- Sales are made with the reservation of ownership referred to in articles 1523 and following of the Italian Civil Code since ownership of the goods sold only passes to the purchaser when the last instalment is paid. The purchaser assumes all risks and dangers, even for accidents and force majeure, undertaking to immediately inform the vendor of any attachments or liens by third parties as well as any removal of the goods to another location.
- The late or missing payment of even a single instalment will lead to the cancellation of the contract by law and the debtor will lose the benefit of extended payment terms. In this case, the customer recognises the right of Il Cavallino Ceramica Artistica S.p.A. to take back the goods sold through recourse to the procedure referred to in article 833 of the Italian Code of Civil Procedure. The vendor will keep all instalments paid to cover the expenses of the sale and the damages suffered except for the right to compensation for greater damages.
- The agreed-upon reservation of ownership also includes the pallets and packing materials. We must be informed of any seizures of our goods.
- The Court of Modena will be exclusively competent for any disagreement or dispute.



formati - sizes - tailles - formate			pz. x box	mq. x box	kg. x box	box x pal.	mq. x pal.	kg. x pal.	
122,6x122,6 cm 48"x48" (lappato R)		10 mm	1	1,50	34,05	26	39,00	926	135x135x55
122,6x122,6 cm 48"x48" (rettificato)		10 mm	2	3,00	65,00	16	48,00	1080	135x135x55
122x122 cm 48"x48" FP2 (rettificato)		20 mm	1	1,49	64,02	18	26,82	1192	135x135x55
90x90 cm 36"x36" (rettificato) (lappato R)		10 mm	2	1,62	34,43	21	34,02	735	94x107x64
90x90 cm 36"x36" FP2 (rettificato)		20 mm	1	0,81	33,86	21	17,01	731	94x107x64
80,0x160,0 cm 31"x62" (rettificato) (lappato R)	NEW	10 mm	2	2,56	54,50	16	40,96	940	90x172x60
61,5x61,5 cm 24"x24" (naturale)		10 mm	4	1,51	34,00	30	45,30	1030	80x120x75
61,3x122,6 cm 24"x48" (rettificato)		10 mm	2	1,50	37,80	36	54,00	1145	80x120x75
61,0x122 cm 24"x48" FP2 (rettificato)		20 mm	1	0,74	31,80	36	26,64	1160	80x120x75
61,0x61,0 cm 24"x24" (rettificato)		10 mm	4	1,49	32,30	30	44,70	980	80x120x75
61,0x61,0 cm 24"x24" FP2 (rettificato)		20 mm	2	0,74	30,94	30	22,20	950	80x120x75
60,0x121,0 cm 24"x48" (lappato R)		10 mm	2	1,45	32,92	36	52,20	1200	80x120x75
45,5x45,5 cm 18"x18" (naturale)		9 mm	8	1,66	32,37	44	73,04	1440	80x120x105
45x90 cm 18"x36" (rettificato)		10 mm	3	1,21	25,00	32	38,72	980	96x120x55
45x90 cm 18"x36" FP2 (rettificato)		20 mm	2	0,81	26,04	27	21,87	932	100x120x55
40x122 cm 16"x48" FP2 (rettificato)		20 mm	2	0,98	40,66	21	20,58	880	94x120x55
30,8x61,5 cm 12"x24" (naturale)		9 mm	7	1,32	25,65	40	52,80	1040	80x120x75
30,6x30,6 cm 12"x12" (naturale) terre toscane/camelot/etruria		9 mm	14	1,31	27,66	60	78,60	1670	80x120x75
30,6x30,6 cm 12"x12" (naturale) terraforte		8,5 mm	16	1,50	28,35	60	90,00	1720	80x120x75
30,5x122,6 cm 12"x48" (rettificato)		10 mm	4	1,50	31,40	36	54,00	1140	94x120x75
30,4x61,0 cm 12"x24" (rettificato)		9 mm	7	1,30	24,50	40	52,00	990	80x120x75
30,4x30,4 cm 12"x12" (rettificato)		9 mm	13	1,20	22,62	40	48,00	915	80x120x75
26,0x160,0 cm 10"x62" (rettificato)	NEW	10 mm	4	1,66	37,01	24	39,84	927	90x172x60
25x60 cm 10"x24" (bicottura)		8 mm	10	1,50	19,50	48	72,00	950	80x120x90
22x90 cm 9"x36" (rettificato)		10 mm	5	0,99	19,00	66	65,34	1326	96x120x80
20,3x122,6 cm 8"x48" (rettificato)		10 mm	4	1,00	21,05	48	48,00	1020	80x120x75
20x50 cm 8"x20" (bicottura)		8 mm	14	1,40	18,93	48	67,20	919	80x120x95
20x40 cm 8"x16" (naturale)		9 mm	13	1,04	19,26	72	74,88	1400	80x120x95
20x20 cm 8"x8" (naturale)		9 mm	32	1,28	23,17	60	76,80	1405	80x120x95
20x20 cm 8"x8" (naturale) gres sp 11/12 mm meteora		11/12mm	24	0,96	23,72	60	57,60	1440	80x120x100
20x20 cm 8"x8" gres sp 7,2 mm		7,2 mm	38	1,52	24,40	60	91,20	1475	80x120x100
15x90 cm 6"x36" (rettificato)		10 mm	8	1,08	21,00	56	60,48	1186	96x120x80
15,1x30,6 cm 6"x12" (naturale) terraforte/ tribeca/meteora/santi		8,5 mm	32	1,48	25,55	60	88,80	1545	80x120x105
15,1x30,6 cm 6"x12" (naturale) terre toscane / camelot / etruria		9 mm	28	1,29	27,18	60	77,40	1641	80x120x105
15x61 cm 6"x24" (rettificato)		9 mm	14	1,28	24,32	50	64,00	1225	80x120x80
pezzi speciali - special pieces - pièces spéciales - formteile									
7,5x61,5 cm 3"x24" battiscopa			12		8,50				
7,5x61,0 cm 3"x24" battiscopa (rettificato)			12		8,50				
7,5x45,5 cm 3"x12" battiscopa			20		12,50				
7,5x30,6 cm 3"x12" battiscopa			36		13,00				
7x90 cm 2 7/8"x36" battiscopa (rettificato)			10		12,90				
6,5x160,0 cm 2 1/2"x62" battiscopa (rettificato)	NEW		6		14,00				
6,5x122,6 cm 2 1/2"x48" battiscopa (rettificato)			10		12,50				
6,5x121 cm 2 1/2"x48" battiscopa (lappato rettificato)			10		12,50				
6,5x90 cm 2 1/2"x36" battiscopa (rettificato) (lux e rettificato)			10		12,90				
6,5x61,5 cm 2 1/2"x24" battiscopa			12		8,50				
6,5x61,0 cm 2 1/2"x24" battiscopa (rettificato)			12		8,50				
6,5x40,0 cm 2 1/2"x16" battiscopa			20		9,90				
6,5x30,8 cm 2 1/2"x12" battiscopa			36		13,00				
6,5x30,6 cm 2 1/2"x12" battiscopa			36		13,00				
6,5x20 cm 2 1/2"x8" battiscopa			30		6,60				

Le informazioni contenute nel presente catalogo sono il più possibile esatte, ma non sono da ritenersi vincolanti. Per esigenze di produzione l'Azienda si riserva il diritto di apportare eventuali modifiche che si rendessero necessarie. Peso, colori e misure sono soggetti alle inevitabili variazioni tipiche del processo di cottura della ceramica. Il colori e gli effetti riportati sul presente catalogo sono indicativi per i limiti consentiti dalla stampa; per questo non possono essere vincolanti e costituire base per eventuali contestazioni.

The information contained in this catalogue is as accurate as possible, but cannot be considered as legally binding. The Company reserves the right to make any modifications that become necessary due to production requirements. Weight, colours and dimensions are subject to the inevitable variations typical of the ceramic firing process. Colours and aesthetic effects shown on this catalogue should be considered indicative and approximate as a result of printing process limits. Possible variations may occur and can not be at the base of any claim.

Les informations reprises dans ce catalogue sont exactes, mais elles n'engagent aucunement notre Société du point de vue légal. Pour des exigences de production la Société se réserve le droit d'opporter toutes les dimensions sont assujettis aux variations typiques du processus de cuisson de la céramiques. Les couleurs et les effets présentés dans ce catalogue sont indicatifs dans la mesure permise par la presse, ce qui explique pourquoi ils ne peuvent pas être obligatoire et constituer la base d'un éventuel désaccord.

Die informationen des vorliegenden Katalogs sind so exakt wie möglich, sind jedoch nicht als gesetzlich verbindlich zu betrachten. Aus Fertigungsgründen behält die Firma sich das Recht vor, eventuell notwendige Änderungen vorzunehmen. Gewicht, Farben und Abmessungen unterliegen den unvermeidlichen Veränderungen, die für den Brennvorgang von Keramikprodukten typisch sind. Die in diesem Katalog gezeigten Farben und Effekte sind Richtwerte, soweit durch die Presse, die ist, warum sie nicht bindend und stellen die Grundlage für eine Meinungsverschiedenheit gestattet.

Credit:

Marketing:
Il Cavallino

Progetto Grafico:
EUREKA

stampa:

finito di stampare:
SETTEMBRE 2020

Note / Notes / Notes / Anmerkungen /

I battiscopa e gli elementi "L" vengono venduti a pz. e a scatola completa. Tutti gli altri pezzi speciali vengono venduti al pezzo. I gradini vengono prodotti solo su ordinazione (tempo minimo di consegna 20 gg lavorativi). All skirting and monolithic L elements, priced per piece, are sold in full box. All other special trims are sold by piece. Steps are produced only on request (minimum delivery terms of 20 days). Les plinthes et élément "L" sont vendues la pièce et par boîte complete. Les autres pièces spéciales sont vendus la pièce. Le plat de marche sont produit sur demande (délai minimum de 20 jours). Die Sockelleisten und Stufen werden pro Stk. und Vollen Kartons verkauft. Stufen und Stufenecken werden nur auf Bestellung produziert (Lieferzeiten mindesten 20 arbeitstagen ab Auftragserteilung).





IL CAVALLINO
CERAMICHE since 1968

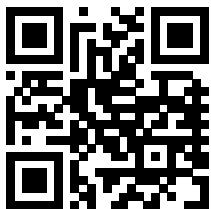

IL CAVALLINO Ceramica Artistica S.p.a.
Via 2 Giugno, 3/5
41040 Fiorano Modenese -
frazione Spezzano (MO) Italy
tel. +39 0536 84 39 64
fax Commerciale +39 0536 84 56 50
fax Amministrazione +39 0536 92 15 86
www.ceramicacavallino.it
ilcavallino@ilcavallinocer.it

“  ”
Ceramics of Italy